



**HEWLETT
PACKARD**

Measurement/Computation

ELECTRONIC INSTRUMENTS AND SYSTEMS

1982

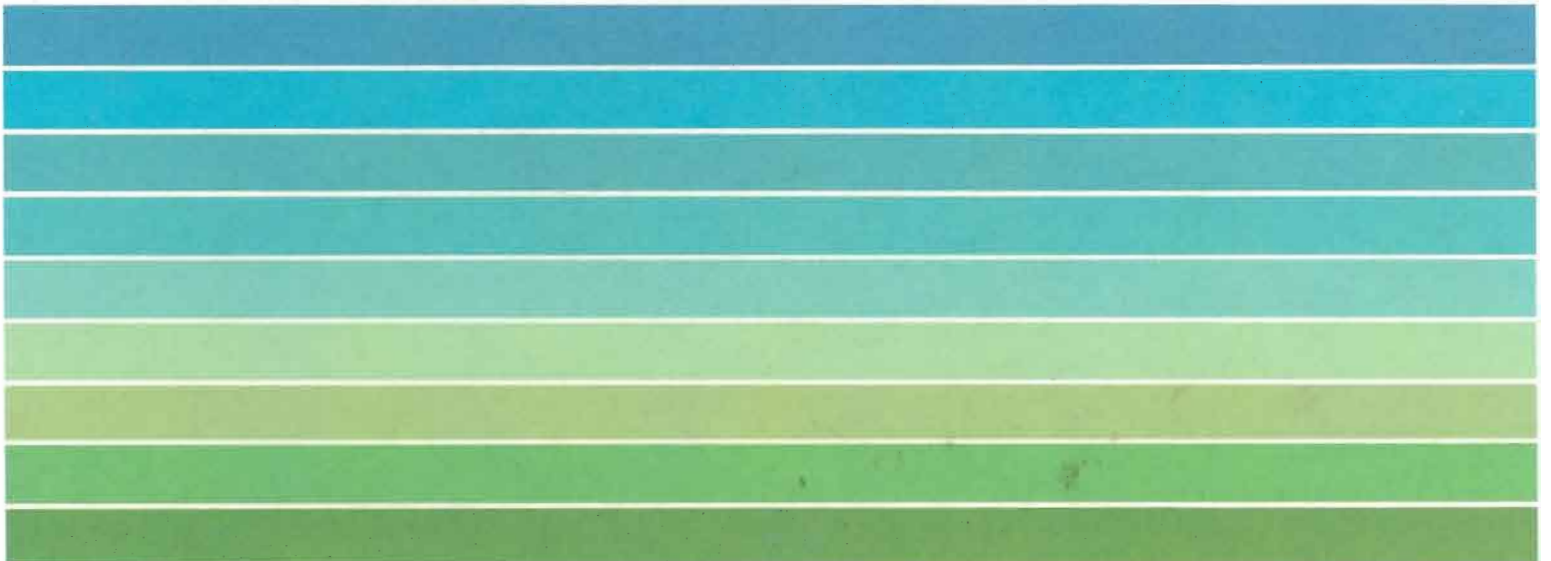

AT HEWLETT-PACKARD

Our business is the practical application of high technologies. HP applies its scientific and engineering resources to two fundamental areas: Measurement and Computation. The company makes more than 4000 products with broad applications in the fields of science, engineering, business, industry, medicine, and education.

HP has manufacturing facilities in more than 30 cities throughout the world and has more than 172 sales offices worldwide.

Product Development

Traditionally, HP invests from eight to ten percent of its sales revenue in research and development. The largest share of these dollars support product development programs within HP's manufacturing divisions. This level of commitment enables the company to employ the latest technologies in developing innovative products that can be reliably produced, delivered, and supported on a continuing basis.

Most of the page numbers shown refer to the beginning of available literature.



GENERAL PURPOSE ELECTRONIC INSTRUMENTS & SYSTEMS

Accessories	82, 86, 224, 761, 764	Circuit Test Systems	180	Diagnostic Analyzers	37
Amplifiers	87	Computer Traces	408	Electronic Counters	31
Cathodes	761	Digital Circuit Traces	340	Function Generators & Oscillators	37

RF & MICROWAVE MEASUREMENT

Accessories	312	Measurement Equipment	312
Amplifiers	67	Measurement Link Analyzers	617
Electronic Counters	374	Measurement Subassemblies	325
Frequency Synthesizers	90	Measurement Test Equipment	490

LOGIC & PROCESSOR-BASED CIRCUIT ANALYSIS

Accessories	156, 360	IC Test/Debuggers	174
Circuit Test Systems	180	Logic Analyzers	166
Digital Circuit Traces	144	Microprocessor Development	140
Digital Test Systems	124	Traces	140

DIGITAL SIGNAL ANALYSIS (FOURIER)

Digital Vectors Control System	370	Spectrum Analyzers	366, 368
Power Analyzers	366		

DATA ACQUISITION & CONTROL PRODUCTS

Circuit Test Systems	208	Data Acquisition Test & Control Systems	36
Computers, Peripherals & Cathodes	444	Digital Subscribers	36
		Micrologic Control	31

TELECOMMUNICATIONS TEST EQUIPMENT

Accessories	36	Frequency Division Multiplexing (FDM)	117
Radio Maintenance & Characterization Testers	445	Frequency Synthesizers	37
Time Communications Testers	392	Measurement Radio Tester	653

HEWLETT-PACKARD INTERFACE BUS (HP-IB) SYSTEM PRODUCTS

Component Traces	108	Electronic Counters	31
Computers & Peripherals	444	Electronic Function & Frequency Synthesizers	37
Circuit Test Systems	180		
Digital Vectors	76	Hewlett-Packard Interface Bus	22

COMMERCIAL PROFESSIONALS IN CALCULATORS

Business Computers	667	Component Capabilities Database	241, 243
Calculators	666	CR1 & Data Entry Terminals	668, 672
Computers, Peripherals & Cathodes	444	Data Acquisition Systems	36
		Desktop Computers	674, 675

Other Products

Analogue Instruments for Chemistry	176	Calibrators	37
Cathodes	114	Card Programming Materials	44
		Equipment	44
		CR1 Display	214

AT HEWLETT-PACKARD

Our business is the practical application of high technologies. HP applies its scientific and engineering resources to two fundamental areas: Measurement and Computation. The company makes more than 4000 products with broad applications in the fields of science, engineering, business, industry, medicine, and education.

HP has manufacturing facilities in more than 30 cities throughout the world and has more than 172 sales offices worldwide.

Product Development

Traditionally, HP invests from eight to ten percent of its sales revenue in research and development. The largest share of these dollars support product development programs within HP's manufacturing divisions. This level of commitment enables the company to employ the latest technologies in developing innovative products that can be reliably produced, delivered, and supported on a continuing basis.

Most of the page numbers shown refer to the beginning of available literature.



GENERAL PURPOSE ELECTRONIC INSTRUMENTS & SYSTEMS

Accessories	82, 86, 224, 761, 764	Circuit Test Systems	180	Diagnostic Analyzers	37
Amplifiers	87	Computer Traces	408	Electronic Counters	31
Cathodes	761	Digital Circuit Traces	340	Function Generators & Oscillators	37

RF & MICROWAVE MEASUREMENT

Accessories	312	Measurement Equipment	312
Amplifiers	67	Measurement Link Analyzers	617
Electronic Counters	374	Measurement Subassemblies	325
Frequency Synthesizers	90	Measurement Test Equipment	490

LOGIC & PROCESSOR-BASED CIRCUIT ANALYSIS

Accessories	156, 360	IC Test/Debuggers	174
Circuit Test Systems	180	Logic Analyzers	166
Digital Circuit Traces	144	Microprocessor Development	140
Digital Test Systems	124	Traces	140

DIGITAL SIGNAL ANALYSIS (FOURIER)

Digital Vectors Control System	370	Spectrum Analyzers	366, 368
Power Analyzers	366		

DATA ACQUISITION & CONTROL PRODUCTS

Circuit Test Systems	208	Data Acquisition Test & Control Systems	36
Computers, Peripherals & Cathodes	444	Digital Subscribers	36
		Micrologic Control	31

TELECOMMUNICATIONS TEST EQUIPMENT

Accessories	36	Frequency Division Multiplexing (FDM)	117
Radio Maintenance & Characterization Testers	445	Frequency Synthesizers	37
Time Communications Testers	392	Measurement Radio Tester	653

HEWLETT-PACKARD INTERFACE BUS (HP-IB) SYSTEM PRODUCTS

Component Traces	108	Electronic Counters	31
Computers & Peripherals	444	Electronic Function & Frequency Synthesizers	37
Circuit Test Systems	180		
Digital Vectors	76	Hewlett-Packard Interface Bus	22

COMMERCIAL PROFESSIONALS & CALCULATORS

Business Computers	667	Component Capabilities Database	241, 243
Calculators	666	CR1 & Data Entry Terminals	668, 672
Computers, Peripherals & Cathodes	444	Data Acquisition Systems	36
		Desktop Computers	674, 675

Other Products

Analogue Instruments for Chemistry	176	Calibrators	37
Cathodes	114	Card Engineering Materials	44
		Equipment	44
		CR1 Display	214

AT HEWLETT-PACKARD

Our business is the practical application of high technologies. HP applies its scientific and engineering resources to two fundamental areas: Measurement and Computation. The company makes more than 4000 products with broad applications in the fields of science, engineering, business, industry, medicine, and education.

HP has manufacturing facilities in more than 30 cities throughout the world and has more than 172 sales offices worldwide.

Product Development

Traditionally, HP invests from eight to ten percent of its sales revenue in research and development. The largest share of these dollars support product development programs within HP's manufacturing divisions. This level of commitment enables the company to employ the latest technologies in developing innovative products that can be reliably produced, delivered, and supported on a continuing basis.

Most of the page numbers shown refer to the beginning of available literature.



GENERAL PURPOSE ELECTRONIC INSTRUMENTS & SYSTEMS

Accessories	82, 86, 224, 761, 764	Circuit Test Systems	180	Diagnostic Analyzers	37
Amplifiers	87	Computer Traces	408	Electronic Counters	31
Cathodes	761	Digital Circuit Traces	340	Function Generators & Oscillators	37

RF & MICROWAVE MEASUREMENT

Accessories	312	Measurement Equipment	312
Amplifiers	67	Measurement Link Analyzers	617
Electronic Counters	374	Measurement Subassemblies	325
Frequency Synthesizers	90	Measurement Test Equipment	490

LOGIC & PROCESSOR-BASED CIRCUIT ANALYSIS

Accessories	156, 360	IC Test/Debuggers	174
Circuit Test Systems	180	Logic Analyzers	166
Digital Circuit Traces	144	Microprocessor Development	140
Digital Test Systems	124	Traces	140

DIGITAL SIGNAL ANALYSIS (FOURIER)

Digital Vectors Control System	370	Spectrum Analyzers	366, 368
Power Analyzers	366		

DATA ACQUISITION & CONTROL PRODUCTS

Circuit Test Systems	208	Data Acquisition Test & Control Systems	36
Computers, Peripherals & Cathodes	444	Digital Subscribers	36
		Micrologic Control	31

TELECOMMUNICATIONS TEST EQUIPMENT

Accessories	36	Frequency Division Multiplexing (FDM)	117
Radio Maintenance & Characterization Testers	445	Frequency Synthesizers	37
Time Communications Testers	392	Measurement Radio Tester	653

HEWLETT-PACKARD INTERFACE BUS (HP-IB) SYSTEM PRODUCTS

Component Traces	108	Electronic Counters	31
Computers & Peripherals	444	Electronic Function & Frequency Synthesizers	37
Circuit Test Systems	180		
Digital Vectors	76	Hewlett-Packard Interface Bus	22

COMMERCIAL PROFESSIONALS & CALCULATORS

Business Computers	667	Component Capabilities Database	241, 243
Calculators	666	CR1 & Data Entry Terminals	668, 672
Computers, Peripherals & Cathodes	444	Data Acquisition Systems	36
		Desktop Computers	674, 675

Other Products

Analogue Instruments for Chemistry	176	Calibrators	37
Cathodes	114	Card Engineering Materials	44
		Equipment	44
		CR1 Display	214

Customer Experience

Because HP products are functionally interrelated, the exchange of ideas throughout the company is continuous. A technological achievement in one product area often contributes to improved capabilities in other products and systems. Similarly, the wide range of customer needs improves HP's sensitivity and response. HP considers customer comments and suggestions essential to its continuing efforts to improve product quality and usefulness.

Worldwide Support

All HP products come with complete documentation, including instructions for their most effective and efficient operation. Wherever they are sold, worldwide, HP products are supported by customer training programs, by system analyst and customer engineer assistance where required, and by a worldwide network of parts and repair centers for maintenance and service. To locate the HP office nearest you, please see the listing on pages 749-760.



Contents overleaf

Multimeters, Digital	78	Power Supplies	250	Sweep Oscillators	421
Oscillators	371	Pulse & Data		Voltmeters, Analog	69
Oscilloscopes	194	Generators	348	Voltmeters, Digital	78
Plotters	685	Recorders & Printers	282	Wave Analyzer	512

Network Analyzers	478	RF Voltmeter	77	Transceiver Test Equipment	642
Oscilloscopes	194	Spectrum Analyzers	520		
Power & Noise Figure Meters	446	Signal Generators	393		
RF Impedance Meters	114	Sweep Oscillators	421		

Pulse & Data Generators	348
Signature Analyzers	140, 568

Frequency & Time		Logging Voltmeter	84, 92	Multiprogrammers	55
Data Acquisition	327	Measurement & Control		Plotters	685
Hewlett-Packard Interface Bus	22	Processor	62	Recorders and Printers	282

Microwave Test Equipment	456	Pulse Code Modulation (PCM)	583	Sweep Oscillators	421
Network Analyzers	478	Signal Analyzers	512	Telecommunications Test Equipment	583
Power & Noise Figure Meters	446	Signal Generators	393	Transceiver Test Equipment	642
Pulse & Data Generators	348				

Logic Analyzers	160	Network Analyzers	478	Signal Analyzers	512
Measurement & Control		Oscilloscope Measurement	198	Signal Generator	393
Processor	62	Power & Noise Figure Meters	446	Sweep Oscillators	421
Multiprogrammers	55	Pulse & Data Generators	348	Telecommunications Test	583

Discs/Drivers	675, 678	Multiprogrammers	55	Technical Computers	
Hard Copy Terminals	676	Plotters	685	& Systems	654, 658, 663
Hewlett-Packard Interface Bus	22	Recorders & Printers	282		
Line Printers	682				

Frequency & Time Standards	304	Physical & Optical Measurements	704	Training/Video Tapes	742
Laser Interferometer	705	Quartz Pressure Gauge	706	X-Ray Systems	709
Medical Instrumentation	732	Quartz Thermometer	708		
Optoelectronics Devices	726	Solid State Components	726		

CONTENTS

ALPHABETICAL INDEX 1
MODEL NUMBER INDEX 11

Post-Sales Support Services 746
 Application Notes 734
 Information Request Card back of catalog
 Ordering Information 748
 Sales & Support/Offices 749
 Warranty 746

PRODUCT SECTIONS:

Analytical Instruments for Chemistry	730	Medical Instrumentation	732
Amplifiers	67	Microwave Test Equipment	456
Analog Voltmeters	69	Network Analyzers	478
Cabinets; Transit, Operating & Combining Cases	714	Oscillators	371
Cathode-Ray Tube Displays	234	Oscilloscopes	194
Circuit Test Systems	140	Physical & Optical Measurements	704
Civil Engineering/Measuring Equipment	700	Power & Noise Figure Meters	446
Component Measurement	108	Power Supplies	250
Computers, Peripherals & Calculators	644	Pulse & Data Generators	348
Data Acquisition, Test & Control Systems	38	Recorders & Printers	282
Digital Circuit Testers	144	Signal Analyzers	512
Digital Voltmeters	78	Signal Generators	393
Electronic Counters	315	Sweep Oscillators	421
Function Generators & Frequency Synthesizers	377	Solid State Components	726
Frequency & Time Standards	304	Telecommunications Test Equipment	583
Hewlett-Packard Interface Bus (HP-IB)	22	Training/Video Tapes	542
Logic Analyzers	160	Transceiver Test Equipment	642
Measurement Accessories	710	X-Ray Systems, Scientific & Industrial	709



Identifies products having the Hewlett-Packard Interface Bus (HP-IB) capability. HP-IB is our implementation of the IEEE Standard 488 and the identical ANSI Standard MC1.1, "Digital interface for programmable instrumentation." For the complete story, see pages 22-37.



Identifies newly introduced products or capabilities. New products are also indicated by boldface listings in the Model Number Index.

Specifications describe the product's warranted performance. Parameters that are described as **typical**, **nominal**, or **approximately** (\approx) are non-warranted supplemental characteristics intended to provide information useful to applying the product.



- A**
- AC**
- Digital Voltmeter 78-107
 - Divider Probe 106
 - Probes 106
 - Resistance Meter 73, 84-107
 - True RMS Voltmeters 76, 90-95, 100-104
- Accessories**
- Cables/Connectors 712
 - Camera 231
 - Connectors, Adapters 713
 - Graphics Software 694
 - Modular Enclosures (System II) 714
 - Logic Analyzer 188-193
 - Oscilloscope 224-233
 - Overhead Transparency Kit 694
 - Pulse & Data Generators 367, 711
 - Signal Generator 420
 - SLMS 624-628, 631
 - Spectrum Analyzer 535, 557-567
 - Transit Cases 722
 - Voltmeter 82
- AC to DC Converter** 298
- AC/DC Meter Calibrator** 710
- Active Probes** 330, 499, 631
- Adapters**
- 50-75 Ω 420, 451, 495, 499, 557, 713
 - Cables/Connectors 712
 - Data Link 672
 - Detector 473
 - Noise Source 455
 - Quasi-Peak 535
 - Slotted Line Sweep 466
- Air Line Extensions** 471
- Alphanumeric LED Displays** 727
- AM/FM Signal Generators** 404
- AM/FM/ ϕ M Modulation Analyzer** 568, 570, 578
- AM/FM/ ϕ M Signal Generator** 400
- AM/FM Test Source** 580
- Amplifiers**
- Broadband Preamp 67
 - Distribution 313
 - Plug-Ins for Oscillographic Recorder 294, 297-299
 - Power Supply 277
 - RF/Microwave 68
- Analog Circuit Test System** 143
- Analog-to-Digital Converter** 29, 78-107
- Cards, Multiprogrammer**
- High Speed 55
 - Low Level 55
- Analog Voltmeters** 69-77
- Analyzers**
- Accuracy Enhancement Program for 8409 511
 - Audio 581
 - Audio Spectrum 548, 568, 570
 - Automatic Network 476, 483-485, 496, 511, 570
 - Automatic Spectrum 520-534, 560-567, 570
 - Baseband 639
 - Correlation 568, 570
 - Data Line 597
 - Digital Signal 140-143, 568, 570
 - Distortion 574-577, 568, 570, 581
 - Fourier (FFT) 560, 568, 570
 - Frequency Stability 572
 - Gain-Phase 483, 486, 568
 - HP-IB 191
 - Logic 160-193
 - Low Frequency Impedance 560, 565
 - Low Frequency Spectrum 548, 568, 570
 - Mechanical Impedance 568, 570
 - Microwave Link 633, 634
 - Modal 568, 570
 - Modulation 568, 570, 578
 - Network 478-511
 - Power Spectrum 568, 570
 - Primary Multiplex 584
 - RF Impedance 114, 478
 - RF Signal Modulation 578
 - Selective Level 618
 - Serial Data 568, 570
 - Spectrum 520-567, 570
 - Signature 152, 153, 558-560
 - Structural Dynamics 568
 - Telephone Line 596
 - Timing, Logic 170
 - Transfer Function 568, 570
 - Vibration 558, 568, 570
 - Wave 523, 577
- Applications Manual, Optoelectronics** 726
- Application Notes** 734
- APC-7[®] Series Adapters** 471, 507, 713
- Assembler ROM** 656
- Atomic Clock/Frequency Standard** 304
- Attenuators**
- 75-Ohm General Purpose 634
 - 600-Ohm Balanced & Unbalanced 36, 131
 - Coaxial, Fixed 458
 - Coaxial, Microwave, OEM 457
 - High Power Microwave 458
 - HP-IB Driven 457, 460
 - Coaxial Step 457, 460
 - Waveguide 457, 508
- Automatic**
- Audio Distortion Analyzer 581
 - Calibration DMM 104
 - Capacitance Bridge 129
 - Data Acquisition Systems 38-54
 - Data Logger 46
 - LCR Meter 110
 - Modulation Analyzer 570, 578
 - Pair Identifier 614
 - Test Systems 38-52, 66, 476, 496, 534, 642
 - Network Analyzer 483, 476, 496, 511
 - Selective Level Meter 628
 - Synthesizer 382-389, 396, 398, 400, 415
 - Spectrum Analyzer 520, 534, 560-567, 570
 - Test Equipment 66
 - Transceiver Test System 642

¹ A registered trademark of the Bunker Ramo Corporation

**B**

Balanced 2/4 Wire Audio Channel Selector	585
Bar Code Wand, Digital	726
Bar Graph Array, LED	727
Baseband Analyzer	639
Baseband Analyzer System Software	641
Battery Operated	
Calculators	646-650
Counters	338-346
DMM	84-90, 345
Microwave Power Meter	449, 452
Strip Chart Recorder	293
Beam Lead Diode	729
Bit Error Rate Tester	612
BNC Series Adapters	713
Board Tester, Analog	143
Board Tester, Digital	142
Breadboard Cards, Multiprogrammer	57, 60
Bridge, Directional	474, 494, 499
Broadband Phase Comparator	309
Business Computers	667
Broadband Sampling Voltmeter	77

C

C Meter	125
Cabinet Identification	714
Cabinet Accessories	714-721
Cabinets, System II	714-719
Cabinets, System II, 1/2-width Adapter	360
Cable Assemblies	712
Cables/Connectors	192, 712
Cables, HP-IB	30
Calculators & Peripherals	
Advanced Scientific Programmable	648
Alphanumeric Programmable (441 bytes)	649
Alphanumeric Programmable (2,233 bytes)	649
Business	646
Card Reader	650
Financial Programmable	646
Financial Programmable Slim-Line	646
Fully Programmable	648
Fully Programmable Printing	648
Memory Modules	649
Optical Wand	650
Printer/Plotter	650
Scientific	647
Scientific Programmable	647
Scientific Programmable Slim-Line	647
Surveying	700
Calibration Data, Attenuators	458, 460
Calibrators	
AC/DC Meter Calibrator	710
AM/FM (8901A)	580
Laser	705
Power Meter Calibrator for 432 Series	
Power Meters	453
Range Calibrator for 435A Power Meter	449
Peak Power	453
Capacitance Bridges; Meters	120-123, 125
Capacitors, Decade	130
Card Reader for 1600A	187

Carriage, Slotted Section	466
Carrier Preamplifiers	297
Carrier Testing	616
Cases, Combining	720
Cavity Frequency Meters	465
Cesium Beam Frequency Standard	308
Circuit Test Systems	140-143
Circuit Testers, Digital	144
Civil Engineering Products	700-703
Clips, Logic	148
Clock, Atomic	308
Clock, Digital	29
Clock, Thermal Printer	303
Coaxial Instrumentation	
Accessories	713
Adapters	470, 507, 713
Air Lines	471
Attenuators	457, 458, 460
Crystal Detectors	464
Directional Bridge	474, 494, 499
Directional Couplers	462
Directional Detectors	463, 637
Dual Directional Coupler	462
Fixed Attenuators	458
Filters	346, 420, 468, 475
Frequency Meters	465
Harmonic Mixer	468
High Pass Filter	475
Low-Pass Filters	346, 420, 468, 475
Noise Sources	455
Pad Attenuators	458
Power Sensors	450, 453
Power Splitter	467, 474, 489, 500
Shorts	467
Sliding Load	467
Slotted Line Carriage	466
Slotted Line	466
Slotted Section	466
Step Attenuators	457, 460
Swept Slotted Line Systems	466
Switches	469
Terminations	467
Thermistor Mounts	453
Thermocouple Mounts	450
Waveguide Adapters	470
Comb Generator	557
Combining Cases	720
Communications Test Equipment	583-641
Communications Test Set	598
Comparator, Logic	149
Comparator, Phase	309
Component Measurement	108-139
Components	
Solid State	726-729
Component Oscillators	306, 376
Component Testers	
Digital IC Tester	136
Digital IC Tester Interface Kit	136
Digital IC Test System	133, 138, 142
Computer-based Network Analyzer	476, 496, 511, 570



Computer-based Spectrum Analyzer	520-522, 534
Computer (Desktop) Controlled	
Instrument Systems	511
Computer Supplies	695
Computer System Test	142
Computers & Peripherals	644-699
Automatic Test Systems	66
Business Oriented Computer Systems	653-657, 677
Computer Support	696
Data Capture Terminals	673
Desktop	34, 658-662
Disc Drives	654, 674, 678, 679
Disc/Tape Drives	680
Display Terminals, CRT	668
Graphics Tablet	36, 243, 654, 684, 692
Line Printer	655
Modular Computer	659
Multipoint Data Link	672
Personal	653
Plotters	654, 685-693
Plotter/Printers	693
Printers, Printer Terminal	655, 677
Series 80 Software	657
Supplies, Accessories, Software	695
Tape Drive	682
Technical Computers	34, 653-657, 658-662
Thermal Graphics Printers	655, 675
Printing Terminals	677
Connector Adapters	713
Connectors, Microwave Precision	713
Converters	
A-to-D	29, 55
D-to-A	28, 55
DC to DC	55
Serial-to-Parallel	28, 187
Counters, Electronic	
Counter/Timer	315-321, 327-346
Counter/Tracking Generator	550
Digital Multimeter/Counter	153, 345
DVM	331, 335, 345
F&T Data Acquisition System	327
Low Cost	341, 347
Microwave	321-326
Plug-In Adapters	321
Portable, Battery Operated	338-346
Pulsed RF	321-322
Reciprocal	318, 328, 331, 338
Time Interval	318, 320, 321, 327, 328, 331, 334, 338, 341
Time Interval Probes	330
Universal	315-321, 328-346
Coordinate Determination System	702
Counter/Totalizer Card	60
Couplers, Directional (Coax and Waveguide)	462, 463
CRT Displays	234
Graphics Tablet	36, 234, 243, 654, 684, 692
CRT Terminals	668-671
Crystal Detectors	463-465
Crystal Oscillators	306
Current Probe	71, 82
Current Tracer, Digital	147

D

D/A Converter	28
D/A Converter Cards, Multiprogrammer	57, 60
Data	
Acquisition Systems	38-54, 327
Capture Printer	677
Capture Terminals	673
Communications	594
Coupler	673
Generators	365-370, 592
Line Analyzers	597
Link Adapter	672
Logger	46, 92
Stimuli	365-370
Transmission Test Set	594, 598
Voice Channel Test Set	603
DC	
Milliammeters	71-73, 84-89, 96
Nullmeter	70
Voltage Source	131
Voltmeters	69-107
DC-to-DC Converters	280
DC Power Supplies	250-281
Amplifier/Power Supply	277
Autoranging	260, 266, 268
Condensed Listing	251
Constant-Current Sources	274
Digitally Controlled	266-271
Dual Tracking	272
General Information	250
General Purpose: 10-30 W Output	255
General Purpose: 25-200 W Output	258, 260
General Purpose: 100-2000 W Output	260, 262
General Purpose: 300-11,000 W Output	264
High Voltage	273
HP-IB Programmable	266-271
Microprocessor	280
Modular, DC-to-DC Converters	280
Modular, Single Output, Series Regulated	280
Modular, Dual Output, Series Regulated	280
Modular, 200-600 W, Switching Regulated	280
Modular, 110 W Switching Regulated	280
Modular, Triple-Output Switching	280
Options	278
Precision Voltage Sources	274
Programmable	266-271
Specifications Definitions	254
Decade Capacitors and Attenuators	130
Degausser for 5061A Frequency Standard	309
Desktop Computers and Peripherals	34, 653-657, 658-662
16-bit Parallel Interface	35
BCD Input Interface	35, 656
Computer Support	696
Desktop Computers	34, 652, 658-662



- Digitizer 692
- Disc Interface 35
- Flexible Disc Drives 654, 674
- General Interface 35, 656, 688
- HP-IB Interface 34, 35, 656, 685-693
- Incremental Plotter Interface 35
- I/O Expander 675
- Intelligent Datacomm Interface 35
- Interfacing Summary 666
- Multiprogrammer: I/O Expander & Converter 55
- Plotters, Graphics 654, 685-691
- Plotter/Printers 685-693
- Plotter (Incremental) Interface 35
- Real Time Clock Interface 35
- Serial Interface 35, 656, 685-691, 693
- RS-232-C Serial Interface 35, 656, 685-691, 693
- Tape Degausser 301
- Tape Punch 675
- Thermal Printers 303, 675, 693
- Two Channel Interface 35
- X-Y Plotters 282-289
- Detectors
 - Adapter 473
 - Coaxial, Microwave, OEM 464, 637
 - Crystal, Coaxial and Waveguide 464
 - Directional 463
 - Error 592
 - Error (Bell Compatible) 589
 - ERROR (CEPT and CCITT compatible) 588
 - Slotted Line 466
- Development Station 166
- Development Systems, Logic 166-169
- Digital
 - AC Voltmeters 78-107
 - Analyzer, Logic 160-193
 - Analyzer, Signature 152, 558-567, 570
 - Board Tester 140-143
 - Circuit Test 140-144
 - Current Tracer 147
 - DC Voltmeters 78-107
 - Education Course 158
 - IC Tester 136
 - IC Tester, Interface Kit 136
 - IC Test System 138
 - Impedance Meter 120-125
 - LCR Meter 110-113, 120-124, 127
 - Microprocessor Troubleshooting 140-144
 - Multimeter 84-107
 - Multimeter, Signature 153
 - Oscillator 371-376
 - PC Board Test System 142
 - Power Meters 448
 - Pressure Gauge 706
 - Programmable Power Supplies 266-271
 - Signal Analyzers 512-582
 - Signal Generators 396, 398, 415
 - Signature Analyzer 152, 153, 570
 - Spectrum Analyzers 520-537, 558-570
 - State Analyzer 160
 - Stimuli 365-367
 - Storage Unit 493, 501
 - Test Sets, Digital Logic 150
 - Thermocouple Card, Multiprogrammer 55
 - Thermometer 708
 - To Analog Current Converter Card 55
 - To Analog Voltage Converter Card 55
 - Troubleshooting 144
 - Troubleshooting (Video Tape) 743
 - Vibration Controller 571
 - Voltmeters 78-107
- Digital Input/Analog Comparator Card 55
- Digital Input Card, Multiprogrammer
 - Common Ground 55
 - Isolated Input 55
- Digital-to-Analog Converters 28, 55
- Digital Output Card, Multiprogrammer 55
- Digitizer 692
- Dimensional Inspection Equipment 702
- Diode Tester 84, 93
- Diodes 728, 729
- Directional Bridge 474, 494, 499
- Directional Detectors 463, 637
- Disc Drives 654, 674, 678, 679
- Disc/Tape Drives 680
- Displays, Cathode-ray Tube 234
 - Computer Graphics 243
 - Display System 36, 243, 684
 - Graphics Generator (HP-IB Interface) 243
 - Imaging 246
 - Instrumentation 232
 - LED 727
- Distortion Analyzers 568, 574-577, 581
- Distance Meters 700
- Distribution Amplifier 313
- Double Balanced Mixer 420
- Doublers, Frequency 399, 411, 420
- Down Converter (1.7—14.5 GHz to 70/140 MHz) 636
- Drafting Plotter 690
- DSN/Data Link 672
- Dual Tracking, Power Supply 272
- Dynamics Analyzer, Structural 568
- E**
 - EIA Registered Visible Light
 - Eight Channel Bank Amplifiers 299
 - Eight-pen Plotters 686, 690
 - Emitters/Detectors 726
 - Optical Reflective Sensor 726
 - Electronic Counters 315-347
 - Electronic Distance Meters 700
 - Electronic Total Station 700
 - EMI Measurement Accessory 535
 - Emulators 168
 - Error Measuring Set (1 kb/s—50 Mb/s) 587
 - Error Measuring Set (1 kb/s—150 Mb/s) 592
 - Error Measuring Set (Bell Compatible) 589
 - Error Measuring Set (CEPT & CCITT Compatible) 588
 - Error Rate Measurements 586-589, 592
 - Exerciser, Microprocessor 156
 - Extenders, HP-IB 32



- F**
- Faxitron® X-Ray Systems 709
 - FDM/Carrier Systems Testing 616
 - Fiber Optics 726
 - Filters
 - Bandpass 420
 - Coaxial and Waveguide 420, 468, 475
 - High Pass 475
 - Low Pass 346, 468, 475, 544
 - Fourier Analyzer 568, 570
 - FM Modulation Analyzer 578
 - FM Signal Generators 396, 398, 404
 - Frame Alignment Monitor & Error Detector 586
 - Frequency
 - Counters 315-347
 - Counter/Tracking Generator 550
 - Doublers 399, 411, 420
 - Meters, Coaxial and Waveguide 465
 - Response Test Set 472
 - Stability Analyzer 572
 - Synthesizer, Microwave 415
 - Frequency Reference Card, Multiprogrammer 55
 - Frequency Standards 304
 - Cesium 308
 - Distribution Amplifier 313
 - General Information 304
 - Quartz 307
 - Rubidium 308
 - Standby Power Supplies 314
 - Frequency and Time Standards 304
 - Frequency Selective Meter and Tracking Oscillator 624
 - Frequency Stability Analyzer 572
 - Frequency Synthesizers 384-396, 398, 400, 415, 416
 - Function Generators 353-355, 359, 377-381
 - Functional Tester 143
 - Fuseholder, RF 420
- G**
- Gas Chromatographs 730
 - GC/Mass Spectrometer Systems 731
 - General Purpose Interface
 - Bus Controllers 35
 - General Purpose Integrator Preamp 298
 - Generators
 - Data 592
 - Function 377-381
 - HP-IB Timing 29
 - Jitter 590
 - Noise 455
 - Pattern 587
 - Pattern (Bell Compatible) 589
 - Pattern (CEPT & CCITT Compatible) 588
 - Pulse 142, 379-382, 418
 - Signal 393-417
 - Square Wave 379, 382
 - Sweep 382, 398, 400, 421-445, 637
 - Tracking 388, 538, 542, 548, 550, 552, 555
 - Graphics
 - Generator (HP-IB Interface for displays) ... 36, 243, 684
 - Plotters 654, 685-691
 - Plotter/Printers 693
 - Printers 655, 676, 677
 - High-Speed Desktop 675
 - Software 657, 694
 - Tablet 36, 243, 654, 684, 692
 - Group Delay (Network Analyzer) 490, 511
 - Guarded Digital Multimeter 100-107
- H**
- Harmonic Mixer (Coaxial and Waveguide) 468
 - Hewlett-Packard Interface
 - Bus (HP-IB) 22-37, 656
 - High Gain DC Preamplifier 297
 - High Power Attenuators 458
 - High Power Sensors 450
 - High Resistance Meter 128
 - High Speed A/D Converter Card, Multiprogrammer ... 55
 - High Speed System Voltmeter 98, 100
 - How to Solder (Video Tape) 745
 - How to Use an Oscilloscope (Video Tape) 745
 - HP-IB
 - Analog-to-digital converter 29
 - Analyzers 191, 160
 - ASCII-to-parallel converter 28
 - Cables 30
 - Controlled Attenuator/Switch Driver 460
 - Controlled Channel Selector 585
 - Controllers 35
 - Digital Clock 29
 - Digital-to-Analog Converter 28
 - Extenders 32
 - General Information 22-37
 - Graphics Tablet 36, 243, 684, 692
 - Relay Actuator 28, 29
 - Timing Generator 29
 - VHF Switch 28
- I**
- IC Tester, Digital 136, 140
 - IC Test System, Digital 138
 - Impedance Analyzer 114-117
 - Impedance Meter 118, 130
 - Impedance Transformers (50-75 Ω) 499, 557
 - In-circuit Functional Tester 143
 - Industrial Distance Meter 701
 - Instrument Cart 631
 - Insulation Resistance Meter 100, 128
 - Insulation Test 128
 - Integrators, Reporting 731
 - Interface Bus (HP-IB) 22-37, 656
 - Interface Cards for Desktop Computers 34, 35, 656
 - Interface Kits
 - Logic Analyzer 190-191
 - Multiprogrammer 55
 - Interfacing Summary for Desktop Computers 666
 - Interferometer
 - Laser 705
 - Interrupt Card, Multiprogrammer 55

ALPHABETICAL INDEX

J	
Jitter Generator & Receiver	590
K	
Kits, Rack Mounting	278, 714-721
L	
Laboratory Automation Systems	730
Laboratory Strip Chart Recorders	282, 290-293
Laboratory X-Y Recorders	282-289
Laser Measurement	705
Laser Printing System	682
LCR Meter	110-113, 120-124, 127
LED Displays	727
Light Bar Modules, LED	727
Light Emitting Diodes	726
Limiter	323, 557
Liquid Chromatographs	731
Log Level Preamp	298
Logging Multimeter	92
Logic	
Analyzer, Development System	166
Analyzers	160-187
Analyzer Accessories	188-193
Analyzer Interface Kits	190-191
Clip	148
Current Tracer	147
Comparator	149
Development System	166-169
Probes	145
Pulser	146
Signal Sources	348-370
Troubleshooting Kits	150
Low Distortion Generator	382, 581
Low Distortion Measurement Set	574, 581
Low Frequency Impedance Analyzer	116
Low Frequency Spectrum Analyzer	548, 568, 570
Low Gain Preamplifier	294, 297
Low Level A/D Converter Card, Multiprogrammer	55
Low Resistance Meter	100, 104, 127
M	
Machinery Analyzer	568, 570
Magnetic Tape Recorders, Analog	300-302
Marker Generator	445
Mass Spectrometers	731
Measurement and Control System	64, 568, 570
Mechanical Impedance Analyzer	568, 570
Medical Instrumentation	732
Medium Gain Preamplifier	294, 297
Medium Range Distance Meter	700
Medium Range Total Station	700
Memory Card, Multiprogrammer	55
Meters	
AC	72-107
AC Resistance	72
Capacitance	120-123, 125
Conductance	120-123, 125
Digital Multimeter	78-107
Distortion	581
Frequency	465
Impedance	110-118, 120-124, 130
LCR	110-113, 120-124
Milliammeter, AC	71, 711
Milliammeter, DC	72, 86-97
Milliohmmeter	86-107, 127
Modulation	578
Multifunction	73, 84-107
Noise Figure	454
Ohmmeter	72, 84-105
Peak Power	453
Power (RF/Microwave)	448, 449, 452, 575
Signature Multimeter	153
Standing-Wave-Ratio (SWR)	477
Susceptance	127-129, 110-115
True RMS	76, 90, 92, 100-104
Vector Impedance	118, 130
Microprocessor Exerciser	156
Microprocessor Power Supplies	280
Microprocessor Troubleshooting	144, 160-187
Microprocessor Training	159
Microwave	
Counters	321-326
Diodes	728
Link Analyzers	633
Network Analyzers	476, 503, 509, 511
Power Measuring Equipment	448, 449, 452
Radio Testing	632
Signal Generators	409-417
Spectrum Analyzers	526, 531, 538, 544, 554
Sweep Oscillators	421-445
Synthesizers	416
Test Equipment	456, 472-477
Transistors	728
Milliohmmeter	86-107, 127
Mixers, Double-balanced	420
Mixers, Coaxial and Waveguide	557
Modal Analysis	568, 571
Modem, Short Haul	683
Modular Computer	659
Modular Power Supplies	279
Modulation Analyzer	478
Modulator/Demodulator	638
Modulators, Absorptive	418
Modulators, PIN	418
Modulation Test Source	580
Multi-frequency LCR Meter	110-113, 120-124, 127
Multimeter	73, 88-107
Multimeter, Signature	153
Multiplex (Primary) Analyzer	584
Multiprogrammers	55
Input and Output Cards	57, 60
Mainframes and Extenders	55, 58
N	
N-Series Adapters	713
Network Analysis, General Information	478
Network Analyzers	472-511
Accuracy Enhancement Program for 8409C	511
Automatic	476, 496, 510, 511
Automatic Scalar	476
Scalar	472, 476

Noise
 Analyzer, Acoustic 568, 571
 Analyzer/Modulation 478
 Figure Meter 454
 Generator 455
 Source (IF, UHF, VHF and Waveguide) 455
 Normalizer, Data 493, 501
 Null meter 70

O
OEM
 Component Oscillators 306
 Computers 653
 Displays, CRT 234
 Graphics Plotters 654, 685-691
 Graphics Plotter/Printers 693
 Instrumentation Tape Recorders 300-302
 Microwave Attenuators 457
 Microwave Components 728
 Microwave Crystal Detectors 464
 Microwave Switches 469
 Power Supplies 279
 Series 80 Assembler Package 656
 Strip Chart Recorders 282, 290-293
 X-Y Recorders 282-289
 Ohmmeters 73, 84-107, 127
 Operating & Transit Cases 722-725
 Optical Shaft Encoder 726
 Optocouplers 726
 Optoelectronics 726, 727
 Oscillators
 Audio 372, 581
 Function 377-383
 General Information 371
 Low Distortion 373
 Low Frequency 382
 Pulse 379
 Quartz Component 306
 Sinewave 374
 Squarewave 374, 379, 381, 382
 Sweep 382, 421-445
 Telephone Test 388
 Test 375
 Tracking 388
 Oscillographic Recorders 282, 294-299
 Oscilloscopes 194-233
 Accessories 224
 Camera 231
 Contrast Filters 229
 Digital Waveform Storage 198
 Digitizing 198
 Measurement System 198
 100 MHz Third-channel Trigger View
 Time Interval Averaging 204
 Delta Time 204
 Fast Variable Persistence Storage 204
 Variable Persistence Storage 204
 200 MHz Delta Time Measurements 211
 275 MHz Delta Time Measurements 211

275 MHz Delta Time Measurements
 with Microprocessor 211
 275 MHz Fast Variable Persistence Storage 211
 General Information 194
 Inverter Power Supply for 1700
 Series Oscilloscopes 230
 Large Screen Mainframe 216
 Light Shields 229
 Low Frequency 220, 222
 Plug-In, 180 series 216
 Rack Mount Slides and Adapters 229
 Spectrum Analyzer Plug-In 540, 542, 544
 Testmobiles 232
 Variable Persistence Storage 204, 211
 Viewing Hoods 229
 Outside Plant Cable Test Equipment 613
 Automatic Pair Identifiers 614
 Cable Fault Locator 614
 Conductor Fault Locators 614
 Open/Split Locators 614
 Pressurized Cable Leak Locators 614
 Overhead Transparency Kit 694

P
 pA Meter 132
 Pad, Coaxial Attenuator 458
 Pattern Generator/Error Detector 587-589
 PC Board Testers 140-143
 PCM Test Equipment 583-593
 PCM Test Systems 585
 Peak Power Calibrator 453
 Peak Power Meter, Analog 453
 Personal Calculators 646-652
 Personal Computers 653
 Personality Modules 688
 Phase Comparator 309
 Phase Meters 331, 488, 490, 498, 500, 560
 Phase Modulation Analyzer 568, 570, 578
 Phase Modulation, Signal Generator 403
 Phase Noise Measurement 572
 Phase Sensitive Demodulator 298
 Physical & Optical Measurements 704
 PIN Modulators, Microwave 418
 PIN Photodiodes 726
 Plotter, Drafting 690
 Plotter, Graphics 654, 685-691
 Plotter/Printers 693
 Accessories and Supplies 695
 Plotters, X-Y 282-289
 Portable
 Counters 338, 341, 342
 Desktop Computers 34, 653, 658-662
 Oscilloscope 204
 Signal Generators 408
 Strip Chart Recorders 282, 290-293
 Voltmeter 84-86, 88-90
 X-Ray Systems 709
 Positioning Equipment 701
 Power Meters, RF & Microwave 448, 452
 Power MOS FET 728



- Power Sensors
 RF & Microwave 450, 453
 Power Meter Calibrators 449, 453
 Power Meter/Modulation Analyzer 578
 Power Splitter 474, 489, 500
 Power Supplies
 Amplifier/Power Supplies 277
 Atomic Clock 314
 Condensed Listing 251
 Constant Current Sources 276
 Digitally Controlled 266-271
 Dual Tracking 272
 Frequency Standards 314
 HP-IB Programmable 266-271
 Laboratory 252
 Microprocessor 279
 Modular, DC to DC Converters 280
 Modular, Series Regulated 280
 Modular/Switching Regulated 280
 Precision Voltage Sources 274
 Programmable 266-271
 Specifications Definitions 254
 Standby 314
 Power Supply/Amplifier 277
 Practical Transistors (Video Tape) 744
 Preamplifiers 67, 292-295, 298-299
 Precision Coaxial Connectors 713
 Precision Frequency Source 304
 Precision Oscillator 307
 Precision Voltage Sources 274
 Preselector 555
 Preset C Meter 125
 Pressure Gauge, Quartz 706
 Pressure Recording System 707
 Primary Multiplex Analyzer 584
 Primary Multiplex Analyzer Systems 585
 Printer, Graphics 655, 676, 677
 Printer, Line 655, 682
 Printer/Printer Terminal 676, 677
 Printers, Thermal Graphics 655, 675, 676
 Printer, Thermal Instrumentation 303
 Probes
 Accessories 82-83, 330
 Active 330, 499, 557, 631
 Cable Assembly 228
 Current 71
 Digital Multimeter 82-83, 85
 High Frequency 108, 127-129
 Logic 144, 145
 Logic Analyzer 188
 Miniature 224
 Slotted Line 466
 Temperature 83, 708
 Trigger, Digital 188
 Time Interval 330
 Voltage Divider 85, 225
 Programmable Modulation Analyzer 578
 Programmable ROM Drawer 656
 Programmable Signal Source 396, 398, 400, 415, 416
 PROM Programmer 169, 416
 Pulse Adder, Splitter, Inverter 711
 Pulse and Data Generators 348-370
 Accessories 367, 711
 Pulse/Function Generators 353, 355, 359
 Pulse Generators 348-364
 Pulsers, Logic 146
 Q
 Q-Meter 126
 Quartz Component Oscillator 306
 Quartz Frequency Standard 307
 Quasi-Peak Adapter 535
 Quartz Pressure Gauge 706
 Quartz Thermometer 708
 R
 Rack Mount Kits 193, 714-721
 Power Supply 278
 Range Calibrator (for 435A Power Meter) 449
 Readers, Card 187
 Recorders
 Oscillographic 282, 294-299
 Instrumentation Tape 300-302
 Strip Chart 282, 290-293
 X-Y 282-289
 Reflection/Transmission Test Sets 474, 476, 489, 494, 499, 505
 Reflectometer Bridge 474
 Relay Actuator (HP-IB) 28, 460
 Relay Output Card, Multiprogrammer 55
 Resistance Meter 72-73, 84-107
 Resistor Lamps, LED 727
 Retrofit, Signature Analysis 156
 Return Loss Kit 631
 RF Impedance Analyzer 114
 RF Vector Impedance Meter 118, 130
 RF Voltmeter 77
 RMS Voltmeter 76, 90-95, 97-104
 Rotary Air Line, Coaxial 471
 Rotary Joint, Coaxial 471
 Rotary Vane Attenuators, Waveguide 457
 Rubidium Frequency Standard 308
 S
 S-Parameter Test Sets 489, 494, 504, 506
 Scalar Network Analyzer 472, 476
 Selective Level Measuring Set 618
 Selective Level Voltmeters 523, 628
 Selective Voltmeter 602, 624
 Self-Test Digital Multimeter 100-107
 Semiconductor/Component Test System 133, 511
 Sensors, Microwave Power 450, 453
 Serial-to-parallel Converter 187
 Series 80 ROM's 656
 Short Haul Modem 683
 Shorts, Coaxial 467, 507
 Shorts, Waveguide 467
 Signal Analyzers 512-582
 Audio 568, 570, 581
 Automatic Spectrum 534, 565, 570
 Digital 568, 570
 Distortion 568, 570



General Information	512-519	Synthesized Function Generator	382
Modulation	568, 570, 574, 576, 578	Synthesized Signal Generators	398-400, 416
Spectrum	520-522, 526-567	Synthesized Signal Sources	401, 415, 570
Signal Conditioners	568-571	Synthesizer, Time	356
Signal Coupler Preamp	298	Synthesizers, Automatic	382-389, 396-403, 415, 416
Signal Generators		Synthesizers, Frequency	384, 401, 415
Accessories	420	System, Logic Development	166-169
Avionics	407	System I, System II Cabinets	714-719
General Information	394	System Digital LCR Meter	124
HF, VHF, UHF, SHF	396-417	System Digital Voltmeter	98-107
Microwave	409-417	System Monitor	656
Programmable	396-400, 415, 416	System Software, Baseband Analyzer	641
Pulse Modulator	418		
Synthesized	396-400, 416		
Signal Sources	348-370, 401, 415	T	
Signal Sources, Programmable	350-355, 367-370, 396-400, 415, 416	Tablet, Graphics	36, 243, 654, 684, 692
Signature Analysis	144, 558-564, 570	Tape Cartridge Unit	166
Signature Analysis Stimulus	156	Tape Degausser	301
Signature Analyzer, Digital	152, 570	Tape Recorders, Analog Magnetic	300-302
Signature Multimeter, Digital	153	Technical Computers	34, 653, 658-662
Slotted Lines (Coaxial and Waveguide)	466	I/O Summary	666
Sliding Load (Coaxial and Waveguide)	467	Telecommunications Test Equipment	583-641
SLMS System Software	622	Access Switch	620
SMA, SMB, SMC Series Adapters	713	Amplifier, Error Detector Input	587
Snap-in Fiber Optic Link	726	Amplifier—IF	460, 634
Software, Graphics	694	Attenuator—75 Ω General Purpose	634
Solid State		Audio Channel Selector: HP-IB Controlled	585
Displays/Lamps	727	Balanced 2/4-wire Audio Channel Selector	585
Diodes, Transistors, Integrated Products	728	Baseband Analyzer	639, 641
Source, AM/FM Test	580	Baseband Analyzer System Software	641
Source, Signal	401, 415	Bi-directional Switch	620
Spectrophotometer, UVI/VIS	730	Cable/Conductor Fault Locators	614
Spectrum Analyzers, General Information	512-519	Cable Maintenance and Construction	
Spectrum Analyzers	520-522, 526-571, 639	Test Equipment	613
Spectrum Analyzer Preselector	555	Carrier Testing	616
Stability Analyzer, Frequency	572	Controller: Switch	620
Standards: Frequency and Time	304	Converter, 75 Ω Unbal/110 Ω Bal	587
Standing Wave Ratio (SWR) Meter	477	Data Generator	592
Stepping Motor Control	55	Data Line Analyzers	597
Step Attenuators, Coaxial	457, 460	Detector, Error	588, 589, 592
Storage-Normalizer	493, 501	Down Converter	636
Strip Chart Recorders	282, 290-293	Error Measuring Set (1 kb/s-50 Mb/s)	587
Structural Dynamics	568	Error Measuring Set (1 kb/s-150 Mb/s)	592
Surveying Calculators	700	Error Measuring Set (Bell Compatible)	589
Surveying Equipment	700	Error Measuring Set (CEPT and CCITT compatible)	588
Sweep Oscillators, General Information	421-423	Error Rate Measurements	586-589, 592
Sweep Oscillators	374-376, 421-445, 637	FDM Measurements	616-631
Sweep Signal Generator	398, 400	Frame Alignment Monitor & Error Detector	586
Sweeper Synthesizer	398, 400	HP-IB Controlled Channel Selector	585
Swept Slotted Line	466	Isolator, PCM Test Equipment	587
Switch Controller, HP-IB	460, 620	Jitter Generator & Receiver	590
Switches		Microwave Link Analyzers	633-634
Access, Distribution and Bi-directional	620	Microwave Network Analyzer	503
Automatic Test	66	Microwave Radio Testing	632
HP-IB Driver	460	Modulation Analyzer	578
Coaxial, Microwave OEM	469	Modulator/Demodulator	638
SPST	469	Pair Identifier	614
VHF Switch, HP-IB	28	Pattern Generator/Error Detector	587-589
Swivel Adapter	471	PCM Test Systems	585
		PCM Testing	583

ALPHABETICAL INDEX

Primary Multiplex Analyzer	584	Two-Channel Real Time	
Remote Automatic Surveillance Systems	622	Spectrum Analyzer	568-571
Selective Level Measuring Set	618, 639	Type N Series Adapters	713
Selective Level Meter	618, 624-629	Type N Short	467
SLMS Accessories	631	U	
Spectrum Analyzer	639	UHF Signal Generators	396-404
Switch: Access	620	Ultrasonic Leak Detector	614
Switch Controller	620	Understanding Microprocessors (Video Tape)	742
Telephone Line Analyzer	596	Universal Bridge	129
Transmission Impairment Measuring Set	604-607	Upconverter Simulator for Microwave	
Voice & Data Testing	594	Link Analyzer	637
White Noise Testing	639	V	
Telephone Test Oscillators	601	Vector Impedance Meters	118, 130
Temperature Measurement	83, 230, 708	Vector Network Analyzer	488, 490, 496, 498, 503
Terminal, Data Capture	673	Vector Voltmeter	500
Termination Panel, Multiprogrammer	55	VHF Generator	404
Terminations, Coaxial and Waveguide	467	Vibration Analyzer	568-571
Testmobiles, Oscilloscope	232	Video Tapes	742
Test Oscillators	375	Voice/Data Testing	594
Test Sets, Digital Logic	150	Voltmeters	
Test Sets, Transmission	598, 606	Analog	69-77
Thermal Plotter/Printers	693	Digital	78-107, 331, 334, 345
Thermal Printers	303, 655, 675, 676	RF	77, 578
Thermistor Sensors, Coaxial and Waveguide	453	Vector	110, 500
Thermocouple Power Meters	448, 449	W	
Thermocouple Power Sensors	450	Waveform Analyzer, Fourier	568-571
Thermocouple Scanning Card, Multiprogrammer	55	Waveguide	
Thermometer	708	Attenuators	457
Thermometer, Quartz	708	Coaxial Adapters	470
Time Base	285	Crystal Detectors	465
Time Standard	304	Directional Couplers	463
Time Synthesizer	356	Frequency Meters	465
Timer/Pacer Card, Multiprogrammer	55	Harmonic Mixer	468
Timing Analyzer, Logic	170-172	Holder	471
Timing Generator, HP-1B	29	Low-Pass Filters	468
Total Station	700	Movable Shorts	467
Touch-Hold Probe	82	Reflection/Transmission Test Sets	508
Tracer, Current	147	Shorting Switch	467
Tracking Generators	386-389, 536, 538, 542, 548, 550, 552, 555	Slide Screw Tuners	468
Training/Computer Software	696	Sliding Loads	467
Training/Logic	158	Sliding Shorts	467
Train, Microprocessor	159	Slotted Section	466
Training/Video Tapes	742-745	Stand	471
Transceiver Modulation Analyzer	578	Terminations	467
Transceiver Test System	642	Thermistor Mounts	453
Transducers, Laser	705	Variable Attenuators	457
Transfer Function Analyzer	560	Waveguide-Waveguide Adapters	470
Transmission Impairment Measuring Set	604	White Noise Test Set	639
Transistor Bias Supply	507	X	
Transistor Test Fixtures	504, 506	X-Ray Systems, Scientific & Industrial	709
Transistors		X-Y CRT Displays	234-249
Bipolar	728	X-Y Plotters/Recorders	282-289, 685-691, 693
GaAs Field Effect	728		
Power MOS Field Effect	728		
Transit Cases	722		
Troubleshooting, Digital	144		
True RMS Voltmeter	76, 90-92, 100, 104		
Tuners, Microwave	468		



New product listings are printed in bold face type
 Dates in parentheses are references to recent HP Journal* articles

HP-11C Slim-Line Advanced Programmable with Continuous Memory	647
HP-12C Slim-Line Financial Programmable with Continuous Memory and Special Functions	646
HP-32E Scientific Calculator with Statistics	647
HP-33C Programmable Scientific Calculator with Continuous Memory	647
HP-34C Advanced Programmable Scientific Calculator with Continuous Memory (Aug. 1980)	648
HP-37E Business Calculator	646
HP-38C Advanced Financial Programmable Calculator with Continuous Memory	646
HP-41C Alphanumeric Full Performance Programmable Calculator with Continuous Memory (441 bytes) (Mar. 1980, Jan 1981)	649
HP-41CV Alphanumeric Full Performance Programmable Calculator with Continuous Memory (2,233 bytes)	649
HP-67 Handheld Fully Programmable Calculator	648
DTS-70 Digital Test Systems	142
HP-83A Personal Computer	653
HP-85A Personal Computer (July, Aug. 1980; July 1981)	653
HP-97 Fully Programmable Printing Calculator	648
HP-97S I/O Calculator	662
100	
105A/B Quartz Frequency Standards	307
140T Spectrum Analyzer Mainframe	547
141T System Spectrum Analyzers	536
141T Spectrum Analyzer Mainframe	547
180 series Plug-in Oscilloscopes	216
180C, D High Writing Speed Oscilloscope Mainframes	216
180TR Rack-mount Display Mainframe	540, 542, 544
181A,AR, Variable Persistence Storage Mainframes ..	216
181T, TR Variable Persistence/Storage Display Mainframes	540, 542, 544
182C Large Screen Oscilloscope Mainframe	216
182T Large Screen Display Mainframe	540, 542, 544
197B Oscilloscope Camera	231
200	
200CD Wide Range Oscillator	372
201C Audio Oscillator	372
204C Oscillator	374
204D Oscillator	374
209A Oscillator	374
214B Pulse Generator	357
236A Telephone Test Oscillator	601
239A Low Distortion Oscillator	373
HP 250 Business Computer System	667
281 series Coaxial-Waveguide Adapters	470
292 series Waveguide-Waveguide Adapters	470
300	
HP 300 Business Computer System	667
331A Distortion Analyzer	576
333A Distortion Analyzer	576
334A Distortion Analyzer	576
339A Distortion Measuring Set	574
343A VHF Noise Source	455
346B Noise Source	455
347A series Noise Sources	455
350D Attenuator Set	83
355 series Coaxial Step Attenuators	460
360 series Coaxial Low-pass Filters	468
362A series Waveguide Low-pass Filters	468

375 series Waveguide Variable Attenuators	457
382 series Waveguide Precision Variable Attenuators ..	457
393A Coaxial Variable Attenuator	457
394A Coaxial Variable Attenuator	457

400

400E & EL AC Voltmeters	75
400F & FL AC Voltmeter	75
400 GL AC Voltmeter	75
403B AC Voltmeter	74
410C Voltmeter	73
415E SWR Meter	477
419A DC Null Voltmeter	70
420C Coaxial Crystal Detector	464
422A series Waveguide Crystal Detectors	465
423A/B Coaxial Crystal Detectors	464
424A series Waveguide Crystal Detectors	465
427A Voltmeter	72
428B Clip-on DC Milliammeter	71
432 series Power Meters	452
435B Power Meter	449
436A Power Meter	448
440A Detector Mount	466
442B Slotted Line RF Probe	466
444A Slotted Line Untuned Probe	466
447B Slotted Line Detector Probe	466
448B Slotted Line Sweep Adapter Probes	466
478A Coaxial Thermistor Mount	453
486A series Waveguide Thermistor Mounts	453
489A TWT Amplifier	68
491C TWT Amplifier	68
493A TWT Amplifier	68
495A TWT Amplifier	68

500

532 series Waveguide Frequency Meters	465
536A Coaxial Frequency Meter	465
537A Coaxial Frequency Meter	465
545A Logic Probe	145
546A Logic Pulser	146
547A Current Tracer	147
548A Logic Clip	148

600

618C SHF Signal Generator	410
620B SHF Signal Generator	410
626A SHF Signal Generator	411
628A SHF Signal Generator	411
651B Test Oscillator	375
652A Test Oscillator	375
654A Test Oscillator	375
680 Strip Chart Recorder	290

700

752 series Waveguide Directional Couplers	463
774D Coaxial Dual Directional Coupler	462
775D Coaxial Dual Directional Coupler	462
776D Coaxial Dual Directional Coupler	462
777D Coaxial Dual Directional Coupler	462
778D Coaxial Dual Directional Coupler	462
779D Coaxial Directional Coupler	462
786D Coaxial Directional Detector	463
787D Coaxial Directional Detector	463
788C Coaxial Directional Detector	463
789C Coaxial Directional Detector	463
796D Coaxial Directional Coupler	462

*A monthly publication of technical information from the HP Laboratories.



MODEL NUMBER INDEX

New product listings are printed in bold face type

Dates in parentheses are references to recent HP Journal* articles

797D Coaxial Directional Coupler	462	1351S Computer Graphics Display System	36, 243, 684
798C Coaxial Directional Coupler	462	1600A 16 Bit Logic State Analyzer	185
800		1600S Logic State Analyzer	185
805C Coaxial Slotted Line	466	1602A 16 Bit Logic State Analyzer	177
809C Slotted Line Carriage	466	1607A 16 Bit Logic State Analyzer	185
810B series Waveguide Slotted Sections	466	1610A/B Logic State Analyzer (May 1980)	173
816A Coaxial Slotted Section	466	1611A Logic State Analyzer (May 1980)	181
817B Coaxial Swept Slotted Line System	466	1615A Logic Analyzer	170
870A series Waveguide Slide Screw Tuners	468	1640B Serial Data Analyzer	608
895A General Purpose Power Supply	262	1645A Data Error Analyzer	612
900		1645S Data Transmission Test Set	612
905A Coaxial Sliding Load	467	1700 series Oscilloscopes	204
907A Coaxial Sliding Load	467	1715A 200 MHz Δ Time Oscilloscope	211
908A Coaxial 50-Ohm Termination	467	1722B 275 MHz Δ Time Oscilloscope, with Microprocessor	211
909A Coaxial 50-Ohm Termination	467	1725A 275 MHz Δ Time Oscilloscope	211
910 series Waveguide Terminations	467	1727A 275 MHz Oscilloscope	211
911A/C Coaxial Sliding Loads	467	1740A 100 MHz Oscilloscope, Third-Channel Trigger View	204
914 series Waveguide Sliding Loads	467	1741A 100 MHz Oscilloscope, Variable Persistence Storage, Third-Channel Trigger View	204
920 series Waveguide Moving Shorts	467	1742A 100 MHz Δ T Oscilloscope, Trigger View	204
923A Waveguide Sliding Short	467	1743A 100 MHz Crystal Δ Time Oscilloscope, Third Channel Trigger View	204
930A Waveguide Shorting Switch	467	1744A 100 MHz Oscilloscope, Fast Variable Persistence Storage, Trigger View	204
932A Waveguide Harmonic Mixer	468	1801A Dual Channel Vertical Amplifier, 50 MHz	217
934A Coaxial Harmonic Mixer	468	1805A Dual Channel Vertical Amplifier, 100 MHz	217
938A Frequency Doubler Set	411	1809A Four Channel Vertical Amplifier, 100 MHz	218
940A Frequency Doubler Set	411	1821A Time Base/Delay Generator	218
1000		1825A Time Base and Delay Generator	219
HP 1000 Computers and Systems (July 1981)	663	1950A Two Channel Expansion Module	198
1006A Testmobile	232	1980A/B Oscilloscope Measurement System	198
1007A Testmobile	232	2000	
1008A Testmobile	232	2103LK Computer	665
1051A & 1052A Combining Cases	720	2109EK Computer	665
1081B Liquid Chromatograph	731	2111F Computer	665
1084B Liquid Chromatograph	731	2113E Computer	665
1110B Current Probe	226	2117F Computer	665
1111A AC Current Amplifier	226	2142A Microsystem Processor Unit	664
1112A Inverter Power Supply	230	2176C/D System Processor Unit	664
1117B Testmobile, Oscilloscope	233	2177C/D System Processor Unit	664
1120A 500 MHz Active Probe	227	2240A Measurement & Control Processor	64
1121A AC Probe	499	2250 Measurement & Control Processor	62
1122A Probe Power Supply	226	2382A Office Display Terminal	668
1124A 100 MHz Active Probe	226	2608A Line Printer	682
1200B Dual Channel Oscilloscope, 100 μ V/div	220	2621A Interactive Display Terminal	668
1201B Dual Channel Storage Oscilloscope, 100 μ V/div	220	2621P Interactive Display Terminal	668
1205B Dual Channel Oscilloscope, 5 mV/div	220	2622A Display Terminal	669
1220A Dual Channel Oscilloscope, 15 MHz	222	2623A Graphics Terminal	669
1222A Dual Channel, Delay Line Oscilloscope, 15 MHz	222	2624B Display Terminal	670
1304A 32 cm (13 in.) Display	236, 239	2626A Display Station (Mar. 1981)	670
1310B 48.3 cm (19 in.) Display	236, 245	2631B Printer	655, 677
1311B 35.6 cm (14 in.) Display	236, 245	2631G #200 Factory Data Printer	677
1317A 43.2 cm (17 in.) Display	236, 245	2631G Graphics Printer	677
1321B 53.3 cm (21 in.) Display	236, 245	2635B Printer Terminal	677
1332A Small Screen Display	236, 246	2642A Display Station	671
1333A Small Screen Display	236, 246	2645A Display Station	671
1335A Small Screen Display	236, 246	2647A Intelligent Graphics Terminal	671
1336S Small Screen Display	236, 246	2648A Graphics Terminal	671
1340A Display Module	236, 246	2671A Printer	655, 676
1345A Digital Display	238, 241	2671G Graphics Printer	655, 676
1351A Graphics Generator	36, 243		



2673A Intelligent Graphics Printer	655, 676	3582A Spectrum Analyzer	560
2680 Laser Printing System	682	3585A Spectrum Analyzer	520
2804A Quartz Thermometer	708	3586A/B Selective Level Meter (May 1980)	624
2813B Quartz Pressure Probe	706	3586C Wave Analyzer (May 1980)	523
2816A Pressure Signal Processor	706	3702B IF/BB Receiver (70 MHz IF)	634
2820A Pressure Recording System	707	3707A BB + Sweep Generator	633
		3710A IF/BB Transmitter (70 MHz IF)	634
		3711A IF/BB Transmitter (70/140 MHz IF)	634
		3712A IF/BB Receiver (70/140 MHz IF)	634
		3717A 70 MHz Modulator/Demodulator	638
3000		3724A Baseband Analyzer	639
HP 3000 Series 44, & Series 30 Business		3725A Display	639
Computer Systems	667	3726A Filter Mainframe	639
3040A Network Analyzer	483	3730B Down Converter: RF to IF	636
3042A Network Analyzer	484	3736B RF Module (1.7 to 4.2 GHz)	636
3044A/3045A Spectrum Analyzers	565	3737B RF Module (3.7 to 8.5 GHz)	636
3046A/B Selective Level Measuring System	628	3738B RF Module (5.9 to 11.7 GHz)	636
3054A Automatic Data Acquisition/Control		3739B RF Module (10.7 to 14.5 GHz)	636
System (July 1981)	42	3743A IF Amplifier	634
3054C Automatic Data Acquisition/Control System	45	3746A Selective Level Measuring Set (32 MHz)	618
3054DL Automatic Data Logger	46	3747A/B Selective Level Measuring Set (90 MHz)	618
3060A Circuit Test System	143	3750A Attenuator: 75 Ω	634
3074A/M Data Link Adapter	672	3754A Access Switch	620
3075A Desktop Data Capture Terminal	673	3755A Switch Controller	620
3076A Wall-Mounted Data Capture Terminal	673	3756A 90 MHz Bi-directional Switch	620
3077A Wall-Mounted Time Reporting Terminal	673	3757A 8.5 MHz Access Switch	620
3078A Data Coupler	673	3762A Data Generator	592
3310A Function Generator	379	3763A Error Detector	592
3310B Function Generator	379	3770B Telephone Line Analyzer	596
3311A Function Generator	380	3771A Data Line Analyzer (CCITT)	597
3312A Function Generator	381	3771B Data Line Analyzer (BELL)	597
3320B Frequency Synthesizer	384	3777A HP-IB-controlled Channel Selector	585
3325A Function Generator/Frequency		3779C Primary Multiplex Analyzer (CEPT)	584
Synthesizer/Sweeper	382	3779D Primary Multiplex Analyzer (Bell)	584
3330B Automatic Synthesizer	385	3780A Pattern Generator/Error Detector	587
3335A Frequency Synthesizer	386, 630	3781A Pattern Generator (CEPT and	
3336A/B/C Synthesizer/Level		CCITT Compatible)	588
Generator (May 1980)	388, 626	3781B Pattern Generator (BELL Compatible)	589
3350 series Laboratory Automation Systems	730	3782A Error Detector (CEPT and CCITT Compatible)	588
3388A Reporting Integrator	731	3782B Error Detector (BELL Compatible)	589
3390A Reporting Integrator	731	3783A Frame Alignment Monitor & Error Detector	586
3400A RMS Voltmeter	76	3785A Jitter Generator & Receiver (CEPT)	590
3403C True RMS Voltmeter	94	3785B Jitter Generator & Receiver (Bell)	590
3406A Broadband Sampling Voltmeter	77	3808A Medium Range Distance Meter	700
3435A Digital Voltmeter	86	3810B Medium Range Total Station	700
3437A High Speed Digital Voltmeter	98	3820A Electronic Total Station (Sept. 1980)	700
3438A 5-Function DMM; HP-IB	96	3822A Coordinate Determination System (Sept. 1980)	702
3455A 6½ Digit DMM	104	3850A Industrial Distance Meter (Jun. 1980)	701
3456A Systems DVM (Apr. 1981)	100	3964A Instrumentation Tape Recorder	289
3465A 4½ Digit DMM	88	3968A Instrumentation Tape Recorder	289
3465B Digital Multimeter	88		
3466A 4½ Digit Autoranging DMM	90		
3467A Logging DMM	92		
3476A/B 3½ Digit DMM	84		
3490A Multimeter	106		
3495A Scanner	53	4000	
3497A Data Acquisition/Control Unit (July 1981)	48	4061A Semiconductor/Component Test System	134
3529A Magnetometer Probe	71	4140B pA Meter/DC Voltage Source	132
3550B Communications Test Set	603	4191A RF Impedance Analyzer (Jan. 1980)	114
3551A Transmission Test Set	598	4192A LF Impedance Analyzer (Sept. 1981)	116
3552A Transmission Test Set	598	4193A Low Frequency Impedance Analyzer	118
3555B Transmission & Noise Measuring Set	600	4204A Oscillator	376
3556A Psophometer	600	4260A Universal Bridge	129
3575A Gain/Phase Meter	486	4261A Digital LCR Meter	120
3580A Spectrum Analyzer	558	4262A Digital LCR Meter	122
3581A Wave Analyzer	577	4265B Universal Bridge	129
3581C Selective Voltmeter	602	4271B Component Test 1 MHz	
		Digital LCR Meter	124
		4272A 1 MHz Preset Capacitance Meter	125

MODEL NUMBER INDEX

New product listings are printed in bold face type
Dates in parentheses are references to recent HP Journal* articles

4273A 1 kHz Preset C Meter	125	5311B Digital-to-Analog Converter	346
4274A LCR Meter	110	5312A HP-IB Interface Module	346
4275A LCR Meter	110	5314A Universal Counter	341
4328A Milliohmmeter	127	5315A & 5315B Universal Counters	338
4329A High Resistance Meter	128	5316A Universal Counter (Sept. 1980)	338
4332A LCR Meter	127	5328A Universal Counter	334
4342A Q Meter	126	5335A Universal Counter (Sept. 1980)	331
4436A Attenuator	131	5340A Microwave Frequency Counter	326
4437A Attenuator	131	5342A Microwave Frequency Counter	324
4440B Decade Capacitor	131	5343A Microwave Frequency Counter (Apr. 1980)	324
4800A Vector Impedance Meter	130	5345A Electronic Counter (Apr. 1980)	318
4815A Vector Impedance Meter	130	5353A Channel C: Plug-in for 5345A	321
4904A Cable Fault Locator	614	5354A 4 GHz Frequency Converter	321
4905A Ultrasonic Leak Detector	614	5355A Automatic Frequency Converter (Apr. 1980)	322
4910G Open and Split Locator	614	5356A & 5356B Frequency Converter	
4930A Conductor Fault Locator	614	Heads (Apr. 1980)	322
4935A Transmission Impairment Test Set	606	5356C Frequency Converter Head (Apr. 1980)	322
4936A Transmission Impairment Measuring Set	607	5359A Time Synthesizer	356
4940A Transmission Impairment Measuring Set	604	5363B Time Interval Probes	330
4943A Transmission Impairment Measuring Set	605	5370A Universal Counter	328
4944A Transmission Impairment Measuring Set	605	5381A Frequency Counter	347
4960/4961 Automatic Pair Identifier	614	5382A Frequency Counter	347
5000		5383A Frequency Counter	347
5001A Microprocessor Exerciser (6800)	156	5390A Frequency Stability Analyzer	572
5001C Microprocessor Exerciser (8085)	156	5391A Frequency and Time Data	
5001D Microprocessor Exerciser (Z80)	156	Acquisition System	327
5004A Signature Analyzer	152	5420A Digital Signal Analyzer	568
5005A Signature Multimeter	153	5423A Structural Dynamics Analyzer	568
5011T Logic Troubleshooting Kit	150	5427A Digital Vibration Control System	571
5015T Logic Troubleshooting Kit	150	5451C Fourier Analyzer	570
5021A Logic Troubleshooting Kit	150	5501A Laser Transducer	705
5022A Logic Troubleshooting Kit	150	5526A Laser Measurement	705
5023A Logic Troubleshooting Kit	150	5700 series Gas Chromatographs	730
5024A Logic Troubleshooting Kit	150	5840A Gas Chromatograph	730
5035A Basic Logic Lab	158	5880A Gas Chromatograph	730
5035T Logic Lab	158	5986A GC/Mass Spectrometer	731
5036A Microprocessor Lab	159	5992 series GC/Mass Spectrometers	731
5045A Digital IC Tester	136	5993B series GC/Mass Spectrometers	731
5046A Digital IC Test System	138	5995A GC/Mass Spectrometer	731
5060 series Cooling Kits	725	6000	
5060 series Control Panel Covers	725	6002A Extended Range DC Power Supply	268
5060 series Filler Panels	724	6111A-6116A Precision DC Power Supplies	274
5060 series Rack Adapter Frames	724	6012A Autoranging Power Supply (Aug. 1981)	260
5060 series Rack Mounting Kits	724	6024A Autoranging DC Power Supply (Aug. 1981)	260
K02-5060A Standby Power Supply	314	6034A 200 Watt Autoranging System Power Supply	266
5061A Cesium Beam Frequency Standard	308	6129C-6131C Digitally Controlled Voltage	
5061A with Option 004 Tube	308	Sources	270
E21-5061A Flying Clock (Cesium)	309	6140A Digital Current Source	270
5061-series System II Accessories	718, 719	6177C Precision DC Current Source	274
5065A Rubidium Frequency Standard	308	6181C Precision DC Current Source	274
E21-5065A Portable Rubidium Time Standard	310	6186C Precision DC Current Source	274
5085A Standby Power Supply	314	6200B-6209B DC Power Supplies	255-257
5087A Distribution Amplifier	313	6212A-6218A DC Power Supplies	255-257
5150A Thermal Printer	303	6224B DC Power Supply	258-259
5300A Counter Mainframe	343	6226B DC Power Supply	258-259
5300B Counter Mainframe	343	6227B Dual Tracking DC Power Supply	272
5301A 10 MHz Counter Module	344	6228B Dual Tracking DC Power Supply	272
5302A 50 MHz Universal Counter Module	344	6234A Dual Output Power Supply	255-257
5303B 500 MHz Counter Module	344	6235A Triple Output Power Supply	256, 257
5304A Timer/Counter Module	344	6236B Triple Output DC Power Supply	256, 257
5305B 1300 MHz Counter Module	345	6237B Triple Output DC Power Supply	256, 257
5306A Digital Multimeter/Counter	345	6253A Dual Output DC Power Supply	258, 259
5307A Frequency Counter Module	345	6255A Dual Output DC Power Supply	258, 259
5308A Timer Counter Module	345	6259B DC Power Supply	262
5310A Battery Pack Module	346	6260B DC Power Supply	262



6261B DC Power Supply	262
6263B DC Power Supply	262
6264B DC Power Supply	262
6265B DC Power Supply	262
6266B DC Power Supply	262
6267B DC Power Supply	262
6268B DC Power Supply	262
6269B DC Power Supply	262
6271B DC Power Supply	262
6274B DC Power Supply	262
6281A DC Power Supply	258
6282A DC Power Supply	258
6284A DC Power Supply	258
6286A DC Power Supply	258
6289A DC Power Supply	258
6291A DC Power Supply	258
6294A DC Power Supply	258
6296A DC Power Supply	258
6299A DC Power Supply	258
6384A DC Power Supply	255-257
6428B DC Power Supply	264
6433B DC Power Supply	264
6434B DC Power Supply	264
6438B DC Power Supply	264
6439B DC Power Supply	264
6443B DC Power Supply	264
6448B DC Power Supply	264
6453A DC Power Supply	264
6456B DC Power Supply	264
6459A DC Power Supply	264
6464C DC Power Supply	264
6466C DC Power Supply	264
6469C DC Power Supply	264
6472C DC Power Supply	264
6475C DC Power Supply	264
6477C DC Power Supply	264
6479C DC Power Supply	264
6483C DC Power Supply	264
6515A High Voltage DC Power Supply	273
6516A High Voltage DC Power Supply	273
6521A High Voltage DC Power Supply	273
6522A High Voltage DC Power Supply	273
6525A High Voltage DC Power Supply	273
6824A DC Power Supply/Amplifier	277
6825A DC Power Supply/Amplifier	277
6826A DC Power Supply/Amplifier	277
6827A DC Power Supply/Amplifier	277
6920B AC/DC Meter Calibrator	710
6940B Multiprogrammer	55, 61
6941B Multiprogrammer Extender	55, 61
6942A Multiprogrammer	58, 61
6943A Multiprogrammer Extender	58, 61

7000

7004B X-Y Recorder	288
7010B X-Y Recorder	284
7015B X-Y Recorder	284
7034A X-Y Recorder	288
7035B X-Y Recorder	285
7044B X-Y Recorder	286
7045B X-Y Recorder	286
7046B X-Y Recorder	286
7047A X-Y Recorder	286

7130A Strip Chart Recorder, 2 Pen	291
7131A Strip Chart Recorder, 1 Pen	291
7132A Strip Chart Recorder, 2 Pen	292
7133A Strip Chart Recorder, 1 Pen	292
7155B Portable Strip Chart Recorder	293
7220C 8-Pen Graphics Plotter	686
7220T 8-Pen Plotter/Paper Advance	686
7221C 8-Pen Graphics Plotter	686
7221T 8-Pen Plotter/Paper Advance	686
7225B Graphics Plotter	654, 688
7240A Thermal Plotter/Printer	693
7245B Plotter/Printer	693
7402A 2-Channel Oscillographic Recorder	294
7404A 4-Channel Oscillographic Recorder	294
7414A 4-Channel Oscillographic Recorder	296
7418A 6 to 8 Channel Oscillographic Recorder	296
7580A 8-Pen Drafting Plotter	690
7906 Disc Drive	678
7908 Disc/Tape Drive	680, 681
7910 Fixed Disc Drive	679
7925 Disc Drive	678
7976A Tape Drive	682

8000

8005B Pulse Generator	358
8007B Pulse Generator	362
8011A Pulse Generator	358
8012B Pulse Generator	360
8013B Pulse Generator	360
8015A Pulse Generator	361
8016A Word Generator	370
8018A Serial Data Generator	367
8080A Mainframe	364-366
8081A Repetition Rate Generator, 300 MHz	364-366
8082A Pulse Generator	363
8083A Output Amplifier, 300 MHz	364-366
8084A Word Generator, 300 MHz	364-366
8091A Repetition Rate Generator, 1 GHz	364-366
8092A Delay Generator/Freq. Divider	364-366
8093A Output Amplifier, 1 GHz	364-366
8111A 1 Hz-20 MHz Pulse/Function Generator	359
8116A Pulse/Function Generator	353
8160A Programmable Pulse Generator	350
8161A Programmable Pulse Generator (Sept. 1981)	350
8165A Programmable Signal Source	355
8170A Logic Pattern Generator	368
8350A Sweep Oscillator	426, 427
8403A Modulator	418
8405A Vector Voltmeter	500
8406A Comb Generator	557
8407A Network Analyzer	498
8408A Automatic Network Analyzer	510
8409C Automatic Network Analyzer	511
8410B Network Analyzer Mainframe	502
8410S series Network Analyzers	509
8411A Harmonic Frequency Converter	503
8412A Phase-Magnitude Display	498, 503
8413A Phase Gain Indicator	508
8414A Polar Display	498, 503
8418A Auxiliary Power Supply	503
8443A Tracking Generator-Counter	550
8444A Tracking Generator	552

*A monthly publication of technical information from the HP Laboratories.

MODEL NUMBER INDEX

New product listings are printed in bold face type
 Dates in parentheses are references to recent HP Journal* articles

8444A Option 059 Tracking Generator	536, 538, 542, 555
8445B Automatic Preselector	555
8447 series Amplifiers	67
8450A UV/VIS Spectrophotometer (Feb. 1980)	730
8470A/B Coaxial Crystal Detectors	464
8471A Coaxial Crystal Detector	464
8472A Coaxial Crystal Detector	464
8473B/C Coaxial Crystal Detectors	464
8477A Power Meter Calibrator	453
8478B Coaxial Thermistor Mount	453
8481A/H Power Sensors	450
8481B Power Sensor	450
8482A/H Power Sensors	450
8482B Power Sensor	450
8483A Power Sensor	450
8484A Power Sensor	450
8485A Power Sensor	450
8491A/B Coaxial Fixed Attenuators	458
8492A Coaxial Fixed Attenuator	458
8493A/B series Coaxial Fixed Attenuators	458
8494A/B/G/H series Coaxial Step Attenuators	460
8495A/B/D/G/H/K series Coaxial Step Attenuators	460
8496A/B/G/H series Coaxial Step Attenuators	460
8498A Coaxial Fixed Attenuator	458
8501A Storage-Normalizer	493
8502A & B Reflection Transmission Bridges	489, 494
8503A & B S-Parameter Test Sets	494
8505A Network Analyzer	490
8507B/C Automatic Network Analyzers	496
8552A Spectrum Analyzer—IF Section	547
8552B Spectrum Analyzer—IF Section	547
8553B Spectrum Analyzer, Tuning Section	550
8554B Spectrum Analyzer, Tuning Section	552
8555A Spectrum Analyzer, Tuning Section	554
8556A Spectrum Analyzer, Tuning Section	548
8557A Spectrum Analyzer	540
8558B Spectrum Analyzer	542
8559A Spectrum Analyzer (Mar. 1980)	544
8565A Spectrum Analyzer	538
8566A Spectrum Analyzer	526, 531
8568A Spectrum Analyzer	526, 528
8569A Spectrum Analyzer	536
8581B Automatic Spectrum Analyzer	534
8582B Automatic Spectrum Analyzer	534
8600A Digital Marker	499
8601A Generator/Sweeper	499
8614A Signal Generator	409
8616A Signal Generator	409
8620 system Sweep Oscillators	435, 499
8620C Sweeper Mainframe	436, 499
8640A,B AM/FM Signal Generators	404
8640B Option 004, Avionics Signal Generator	407
8654A Signal Generator	408
8654B Signal Generator	408
8656A Signal Generator	396
8660A Synthesized Signal Generator	400
8660C Synthesized Signal Generator	400
8662A Synthesized Signal Generator (Feb. 1981)	398
8671A Microwave Frequency Synthesizer	415
8672A Synthesized Signal Generator	416
8683A/B Signal Generators	412
8684A/B Signal Generators	412
8690B Sweep Oscillator	442
8691B-8695B RF Units (PIN leveled BWO) for 8690B	443, 444
8691A-8697A RF Units (Grid Leveled BWO) for 8690B	443, 444
8698B, 8699B Solid State RF Units for 8690B	443, 444
8709A Phase-lock Synchronizer	443
8717B Transistor Bias Supply	507
8721A Coaxial Directional Bridge	499
8731-8735 series PIN Modulators	418
8743B Reflection/Transmission Test Unit	505
8745A S-Parameter Test Set	504
8746B S-Parameter Test Set	506
8747A Waveguide series Reflection/Transmission Test Units	508
8748A S-Parameter Test Set	489
8750A Storage-Normalizer	473, 498, 501, 557
8754A Network Analyzer	488
8755C Frequency Response Test Set Plug-in	473
8755P Automatic Scalar Network Analyzer	476
8755S Frequency Response Test Sets	472
8761A & B Coaxial Switches	469
8801A Low Gain Preamplifier	297
8802A Medium Gain Preamplifier	297
8803A High Gain Preamplifier	297
8805A Carrier Preamplifier	297
8805B Carrier Preamplifier	297
8806B Phase Sensitive Demodulator	298
8807A AC/DC Converter	298
8808A Logarithmic Preamplifier	298
8809A Signal Coupler	298
8815A General Purpose Integrator	298
8820A DC Bank Amplifier	299
8821A DC Bank Amplifier	299
8900B Peak Power Calibrator	453
8901A Modulation Analyzer	578
8903A Audio Analyzer (Aug. 1980)	581
8903A-E85 Semi-Automatic Transceiver Test Set	643
8903A-K52 Combining Cases (for 8903A-E85)	643
8903A-K85 Switching Module (for 8903A-E85)	643
8950B Automatic Transceiver Test System	642
8970A Noise Figure Meter	454
9000	
9030 Measurement and Control System	64
9111A Graphics Tablet (Jan. 1981)	653, 692
9111A Option 050 Graphics Tablet	36, 244, 684, 692
9411A Switch Controller	66
9412A Modular Switch	66
9413A VHF Switch	66
9414A Matrix Switch	66
9815S Desktop Computer	662
9825B, T Desktop Computer	662
9826 Computer System	658
9835A, B Desktop Computer	660
9845B, C, T Desktop Computer (Dec. 1980)	661
9872C 8-Pen Graphics Plotter	686
9872T 8-Pen Plotter/Paper Advance	686
9874A Digitizer	692
9876A Thermal Graphics Printer (Nov. 1980)	675
9878A I/O Expander	675
9885M/S Flexible Disc Drive	675
9895A Flexible Disc Memory	653, 674
9915A Modular Computer (July 1981)	659

10000

10001A 10:1 Divider Probe 225
 10001B 10:1 Divider Probe 225
 10002A 50:1 Divider Probe 225
 10002B 50:1 Divider Probe 225
 10003A 10:1 Divider Probe 225
 10004D 10:1 Divider Probe 225
 10005D 10:1 Divider Probe 225
 10006D 10:1 Divider Probe 225
 10007B 1:1 Probe 82, 225
 10008B 1:1 Probe 82, 225
 10011B BNC Adapter Tip 229
 10013A 10:1 Divider Probe 225
 10014A 10:1 Divider Probe 225
 10016B 10:1 Divider Probe 225
 10017A Miniature Divider Probe 224
 10018A Miniature Divider Probe 224
 10019A Cable Assembly 228
 10020A Resistance Divider Probe 225
 10021A Miniature 1:1 Probe 224
 10022A Miniature 1:1 Probe 224
 10023A Temperature Probe (Mar. 1981) 83, 230
 10024A IC Test Clip 228
 10026A Miniature 1:1 Probe (50 Ω) 224
 10027A Miniature 1:1 Probe (50 Ω) 224
 10028A Jumper Cable 228
 10034A Probe Ground Lead Kit 227
 10035A Probe Tip Kit 227
 10036B Probe Tip Kit 227
 10037B Probe Tip Kit 227
 10040A 10:1 Miniature Divider Probe 224
 10041A 10:1 Miniature Divider Probe 224
 10042A 10:1 Miniature Divider Probe 224
 10050A HP-IB Adapter (1602A) 180
 10051A Test Probe (1602A) 180
 10059A HP-IB Interface (1602A) 180
 10066A HP-IB Probe Interface 191
 10069A HP-IB Interface (1615A) 191
10080A Miniature 10:1 Probe 224
10081A Miniature 10:1 Probe 224
10082A Miniature 10:1 Probe 224
10083A Miniature 1:1 Probe 224
10084A Miniature 1:1 Probe 224
 10100C 50 ohm Feedthrough Termination 229
 10100B 100 ohm Feedthrough Termination 229
 10110B BNC Male to Dual Banana Plug 713
 10111A Shielded Banana Plug to BNC Female 713
 10113A Triple Banana Plug to Dual BNC Female 713
 10116A Light Shield for 1220 Series Oscilloscopes 229
 10117A Panel Cover for 1220 Series Oscilloscopes 223
 10119A Rack Mount Kit for 1220 Series Oscilloscopes 223
 10140A Viewing Hood for 1700 Series Oscilloscopes 229
 10166A Front Panel Cover (180A, 181A, 184A) 229
 10173A RFI Filter and Contrast Screen for 1700 Series Oscilloscopes 229
 10176A Viewing Hood for 12.7 cm (5 in.) Rect. CRT 229
 10178A Metal Mesh Contrast Screen for 181 and 184 series Oscilloscopes 229
 10183A Light Shield HP for small screen displays
10221A 50 Ohm Probing Tee 227
 10229A Retractable Hook Tip Adapter 229
 10230C Clock Probe, Logic Analyzer 188
 10231C Data Probe, Logic Analyzer 188

10233A Cable, 1645A to 5055A or 5150A 612
 10235A Interface Cover for 1645A 612
 10236A Trigger Bus Cable (1600S) 192
 10237A Data Cable (1600S) 192
 10247A Clock Probe 188
 10248C Data Probe 188
 10250A TTL Trigger Probe 223
 10253A Card Reader for 1600A 187
 10254A Serial-to-Parallel Converter 187
 10257B Personality Module for 1611A (6800 μP) 182
 10258B Personality Module for 1611A (8080 μP) 183
 10259A Personality Module for 1611A (0F8 μP) 183
 10260A Personality Module for 1611A (Z80 μP) 183
 10261A Personality Module for 1611A (6502 μP) 183
 10262A Personality Module for 1611A (1802 μP) 184
 10263A Personality Module for 1611A (8085 μP) 183
 10264A GP Personality Module for 1611A (May 1980) 182
10266A Personality Module for 1611A (6809 μP) 182
 10275A PDP-11 UNIBUS Interface 190
 10276A LSI-11 Interface 190
 10277A,B,C General Purpose Interface 189
 10278A HP 1000 series Interface 190
 10279A NOVA 3 Interface 190
 10280A microNOVA Interface 190
 10285A L-Series Logic Analyzer Interface 190
 10281A HP-IB Interface (1640A) 681
 10299A Rack Mount Adapter 193
 10380A OEM Horizontal Frame for HP Small Screen Displays 249
 10382A Bench Hardware Kit for 10380A 249
 10386A OEM Vertical Frame for HP Small Screen Displays 249
 10387A Interface, Type 303 Modems (1645A) 612
 10388A Interface, CCITT V35 (1645A) 612
 10389A Interface, Breakout Box (RS-232C) (1645A) 612
 10407B Plug-in Extender (180 system) 229
 10475A 3 in. Drawer for 1117B 233
 10476A 8 in. Drawer for 1117B 233
 10491B Rack Mount Adapter, 1700 series, 1600A 193, 229
 10494A HP-IB Interface (1610A) 176
 10495A HP-IB Interface (1610A) 176
 10496A HP-IB Interface (1610B) 176
 10499A Field Retrofit Kit (1610A) 176
 10501A Cable Assembly 712
 10502A Cable Assembly 712
 10503A Cable Assembly 712
 10514A Double-balanced Mixer 420
 10519A Cable Assembly 712
 10525T & 10525E Logic Probes 145
 10526T Logic Pulser 146
 10528A Logic Clip 148
 10529A Logic Comparator 149
 10533A BCD Interface Cable (5150A, 5300A) 343
 10534A Double-balanced Mixer 420
 10541A Reference Boards 149
 10541B Preprogrammed Reference Boards 149
 10548A Service Support Package 343
 10638A Degausser 309
 10656A 5035A Texts & Lab Workbooks 158
 10657A 5035A Component & Wire Kit 158
 10811A/B Crystal Oscillators (Mar. 1981) 306
 10819A Leather Carrying Case (5300A/B) 343
 10833 A/B/C/D HP-IB Cables 30

*A monthly publication of technical information from the HP Laboratories.

MODEL NUMBER INDEX

New product listings are printed in bold face type
Dates in parentheses are references to recent HP Journal* articles

10844A Programming Interface Kit (5045A)	139	11665B Modulator for 8755	474
10845A Program Card (5045A)	139	11666A Reflectometer Bridge for 8755	474
10846A Program Card Coupon Book	139	11667A DC-18 GHz Power Splitter	474
10847A 5045A Service Kit	139	11668A 50 MHz High Pass Filter for 8755	475
10851A/52A/53A/54A Rack Mount Kits (5300A/B)	343	11672A Service Accessory Kit for 8660A/C	403
10855A Broadband Preamplifier	336	11675B Leveling Cable Assembly for 784C	637
10856A Low Pass Filter Kit	346	11678A Low Pass Filter Kit	475
11000		11679A/B Extension Cables for 8755	475
11000A Cable Assembly	712	11683A Range Calibrator	449
11001A Cable Assembly	712	11684/5/6/8/9A Low Pass Filters	475
11002A Test Leads	712	11687A Adapter, 50 to 75 Ω	420
11003A Test Leads	712	11690A Frequency Doubler	420
11035A Cable Assembly	712	11691D Coaxial Directional Coupler	462
11036A AC Probe for 410C	73	11692D Coaxial Dual Directional Coupler	462
11068A Soft Carrying Case	82	11693A Limiter	557
11075A & 11076A Instrument Cases	725	11694A Matching Transformer, 50-75 Ω	557
11096B High Frequency Probe	82	11697A/B/C Bandpass Filters	420
11143A Cable Assembly	712	11707A Test Plug-in for 8660A/C	403
11170A/B/C Cable Assembly	712	11708A Attenuator (for Calibrating 8484A)	450
11310A Card Reader		11710B Down Converter	419
11473A-11476A Balancing Transformers	711	11711A Noise Source Adapter	455
11500A/B Cable Assembly	712	11712A Service Support Kit (for 8671A, 8672A)	415
11501A Cable Assembly	712	11713A Attenuator/Switch Driver	460
11509A Fuseholder	420	11714A Service Support Kit (for 8662A)	399
11511A Coaxial Short	467	11715A AM/FM Test Source	580
11512A Coaxial Short	467	11716A, B Interconnection Kits	460
11515A Waveguide Adapter	471	11720A Pulse Modulator	419
11516A Waveguide Adapter	471	11721A Frequency Doubler	399, 420
11517A Mixer	557	11723A Applications Pac (for 8903A-E85)	643
11518A-11520A Waveguide Taper Sections	557	11850A & B Power Splitters	489, 494
11524A APC-7 to N (female) Adapter	471, 713	11851A RF Cable Kit for 8505A	489, 495
11525A APC-7 to N (male) Adapter	471, 713	11852A 50-75 Ω Minimum Loss Pad	495
11533A APC-7 to SMA (male) Adapter	471, 713	11853A 50 Ω Type N Accessory Kit	495
11534A APC-7 to SMA (female) Adapter	471, 713	11854A 50 Ω BNC Accessory Kit	495
11536A Probe Tee for 8405A	500	11855A 75 Ω Type N Accessory Kit	495
11540A Waveguide Stand	471	11856A 75 Ω BNC Accessory Kit	495
11542A-11548A Waveguide Holders	471	11857A/B Test Port Extension Cables for 8503A & B	489, 495
11549A Power Splitter for 8405A	500	11858A Rigid Interconnect Adapter	495
11565A Coaxial Short	467	11863E/F Accuracy Enhancement Program for the 8409B	511
11566A Air Line Extension	471	11866A APC-7 Calibration Kit	507
11567A Air Line Extension	471	11867A RF Limiter	557
11570A Accessory Kit for 8405A	500	11869A Adapter for 86200 Series Plug-ins	434
11581A Attenuator Set	458	11870A Low Pass Filter	544
11582A Attenuator Set	458	12000	
11583A Attenuator Set	458	12002B Memory Card, 512kb	665
11588A Swivel Adapter	471	12009A L-Series HP-1B Interface	35
11589A & 11590A Bias Networks	507	12030A L-Series 10-slot card cage	665
11599A Quick-Connect Adapter for 8745A	508	12032A L-Series 5-slot card cage	665
11600B Transistor Fixture	504	12035A L-Series Computer Power Module	665
11602B Transistor Fixture	504	12539C Time Base Generator	665
11604A Universal Extension for 8745A	504	12791A Firmware Expansion Module	665
11605A Flexible Arm for 8743A	508	12897B Dual-Channel Interface	665
11606A Rotary Air Line	471	12944B Power Fail Recovery System	665
11607A Small Signal Adapter for 8745A	508	12979B HP 1000 Computer I/O Extender	665
11608A Transistor Fixture	506	12990B Memory Extender	665
11609A Cable Kit for 8410S	507	12991B Power Fail Recovery System	665
11610B Test Port Extension Cable	505	13000	
11650A Accessory Kit for 8410S	507	13064A Tape Degausser	301
11652A Reflection/Transmission Kit for 8407A	499	13047A User Control Store	665
11661B Frequency Extension Module	401	13197A Writable Control Store	665
11664A Detector for 8755	473	13306A E-Series Fast FORTRAN Processor	665
11664B Detector for 8755	473	13264A Data Link Adapter	672
11664C Detector Adapter for 8755	473		



14000		
14513A Rack Kit (for one unit, 3½"H)	278	
14515A Rack Kit (for one unit, 5¼"H)	278	
14521A Rack Kit (for Bench Series)	278	
14523A Rack Kit (for two units, 3½"H)	278	
14525A Rack Kit (for two units, 5¼"H)	278	
14533B Pocket Programmer	271	
14534A Pocket Programmer Cable	271	
14535A Interface Kit, DCPS-to-HP 1000 Computers	271	
14536A DCPS Chaining Cable	271	
14539A Cable Assembly, DCPS to HP 1000 Computers	271	
14540A 1000 Cable Assembly, Multiprogrammer-to HP 1000 Computers	57	
14541A Chaining Cable, 6940B or 6941B to 6941B	57	
14550C Interface Kit, Multiprogrammer-to-HP 1000 Computers	57	
14551A Multiprogrammer Service Kit	61	
14555A Multiprogrammer Card Connector	57	
14558A Termination Panel	57	
14560A Cable Assembly	57	
14561A Cable Assembly	57	
14562A Cable Assembly	57	
14700A/14701A Extender Interface Kits	58, 663	
14702A Chaining Cable	58	
14703A Spare Card Connector	58	
15000		
15104A Pulse Adder/Splitter	711	
15115A Pulse Splitter/Inverter	711	
15116A Pulse Inverter	711	
15179A Rack Adapter Frame	360	
15263A Card Reader	367	
15452A-15458A 8170A Accessories	369	
15506A Frame Alignment Generator	593	
15507A Isolator	593	
15508B Impedance Converter	593	
15508C Converter (75 Ω Unbal. - 120 Ω Bal.)	593	
15509A Amplifier	593	
15510A 75 Ω Cable Accessory	593	
15511A 120 Ω Cable Accessory	593	
15512A Cable	593	
15513A Cable	593	
15514A Transit Case	593	
15515B Loop Holding Unit	593	
15575A-H Equalizers	631	
15580A 20 MHz High-Impedance Active Probe	631	
15581B 25 MHz High-Impedance Passive Probe	631	
15582A Return Loss Kit	631	
15584A Transit Case	631	
15585A Diagnostic Kit	631	
15589A Instrument Cart	631	
15600A Isolator (3.7 to 4.2 GHz)	636	
15601A Isolator (5.9 to 6.5 GHz)	636	
15602A Isolator (7.1 to 8.1 GHz)	636	
15603A Isolator (10.7 to 11.7 GHz)	636	
15609A Remote Extender Cable	636	
16000		
16008A Resistivity Cell	128	
16014A Series Loss Test Adapter	126	
16380A Decade Capacitors	131	
16470A/B/C Reference Inductors	126	
17000		
17012B Point Plotter	288	
17012C Point Plotter	288	
17055A Overhead Transparency Kit	694	
17108A Time Base	285	
17170A DC Coupler	289	
17171A DC Preamplifier	289	
17172A Time Base	289	
17173A Null Detector	289	
17174B DC Offset	289	
17175A Filter	289	
17176A Scanner	289	
17178A DC Attenuator	289	
17400A High Gain Preamplifier	294	
17401A Medium Gain Preamplifier	294	
17402A Low Gain Preamplifier	294	
17403A AC Carrier Preamplifier	294	
17580A ISPP Software	694	
17600A General I/O Interface for 7225B	688	
17601A HP-IB Interface for 7225B	688	
17602A 8, 12, 16-Bit Interface for 7225B	689	
17603A RS-232-C Type Interface for 7225B	689	
17604A RS-232-C Interface for 7225B	689	
18000		
18107A External Oscillator (2804A)	708	
18108A Line Amplifier (2804A)	708	
18109A Diagnostic Kit (2804A)	708	
18110A Laboratory Probe and Cal Module, 26 mm (1") (2804A)	708	
18111A Laboratory Probe and Cal Module, 232 mm (9.1") (2804A)	708	
18112A Laboratory Probe and Cal Module, 486 mm (19.1") (2804A)	708	
18115A Heavy Duty Probe and Cal Module, 29 mm (1.1") (2804A)	708	
18116A Heavy Duty Probe and Cal Module, 129 mm (5.1") (2804A)	708	
18117A Heavy Duty Probe and Cal Module, 179 mm (7.1") (2804A)	708	
19000		
19810A Sequence ROM	198	
19811A Plot/Sequence ROM	198	
19860A Digital Waveform Storage	198	
30000		
33300 series Coaxial Step Attenuators	457	
33311B/C Coaxial Switches	469	
33320 series Coaxial Step Attenuators	457	
33330B, C Coaxial Crystal Detectors	464	
34110A Carrying Case	82	
34111A High Voltage Probe	82	
34112A Touch-Hold Probe	82	
35030A Power Line Conditioner	699	
37013A System Software	622	
37014A System Software	622	
37018A Baseband Analyzer System Software	641	
37201A HP-IB Extender	32	
37203A HP-IB Extender	33	
37203L HP-IB Extender (Plug-In Card)	33	
37230A Short Haul Modem	683	
37264A Band Defining Filter (for 3726A)	639	



MODEL NUMBER INDEX

New product listings are printed in bold face type

Dates in parentheses are references to recent HP Journal* articles

37265A Band Stop Filter (for 3726A)	639
37266A Band Stop Filter (for 3726A)	639
37267A Adapter Case (for 3726A)	639
37268A Dummy Plug-in (for 3726A)	639
37269A Front Panel Input Connector (for 3726A)	639
40000	
43804 X-Ray System	709
43805 X-Ray System	709
43807 X-Ray System	709
50000	
59301A ASCII-Parallel Converter	28
59303A Digital-to-Analog Converter	28
59306A HP-IB Relay Actuator	28
59307A HP-IB VHF Switch	28
59308A HP-IB Timing Generator	29
59309A HP-IB Digital Clock	29
59310B HP-IB Computer Interface	35
59313A HP-IB Analog-to-Digital Converter	29
59401A Bus System Analyzer	30
59403A HP-IB Common Carrier Interface	31
59500A Multiprogrammer HP-IB Interface	57
59501A HP-IB Power Supply Programmer	269
K70-59992 Rack Mount Adapter Kit (5342A, 5343A)	325
K34-59991A Broadband Linear Phase Comparator	309
60000	
61000 Modular Power Supplies (OEM)	279
61005C DC-to-DC Converter (single output)	280
61315D DC-to-DC Converter (triple output)	280
62000 & 63000 Modular Power Supplies (OEM)	280
62005A-62048G Modular Power Supplies	280
62212A-62215G Dual Output Modular Supplies	280
62410A Modular Supply Rack Mounting Tray	281
62411A Rack Tray Blank Front Panel	281
62412A Rack Tray Blank Rear Panel	281
62413A Rack Tray Cooling Unit (45 cfm)	281
62414A Rack Slide Kit (for standard cabinets)	281
62415A Rack Tray AC Distribution Panel	281
62416A Rack Tray Cooling Unit (160 cfm)	281
62605L, 62605M, 62615M 300-600 W Switching Power Supplies	280
63005C 110 W Switching Power Supply	280
63300F Modular Power Supplies	280
63315D Triple Output Switching Power Supply	280
64000 Logic Development System (Oct. 1980)	166
64001S Logic Development System	166
64030A Development Station Cart	193
64100A Development Station (Oct. 1980)	167
64200A Emulator, 8080/8085	168
64210A Emulator, 6800	168
64250A Emulator, Z80	168
64300A Logic Analyzer (Oct. 1980)	168
64500A PROM Programmer (Oct. 1980)	168
64940A Tape Cartridge Drive	168
65105A-65612A 50 Watt Modular Switching Power Supplies	279-281
69322A Quad D/A Voltage Converter Card	57
69330A Relay Output Card	57
69331A Digital Output Card	57
69332A Open Collector Output Card	57
69335A Stepping Motor Control Card	57
69336B Scanner Card	57
69351B Voltage Regulator Card	57
69370A D/A Current Converter Card	57
69380A Breadboard Output Card	57
69422A High Speed A/D Converter Card	57
69423A Low Level A/D Converter Card	57
69430A Isolated Digital Input Card	57
69431A Digital Input Card	57
69433A Relay Output With Readback Card	57
69434A Event Sense Card	57
69435A Pulse Counter Card	57
69436A Process Interrupt Card	57
69480A Breadboard Input Card	57
69500A Unloaded Resistance Output Card	57
69501A-69513A Power Supply Control Cards	57
69700A-69706A Resistance Output Card	60
69720A Digital-to-Analog Voltage Converter Card	60
69721A Digital-to-Analog Current Converter Card	60
69730A Relay Output Card	60
69731A Digital Output Card	60
69735A Pulse Train Output/Stepping Motor Control Card	60
69736A Timer/Pacer Card	60
69751A Analog-to-Digital Converter Card	60
69770A Isolated Digital Input Card	60
69771A Digital Input/Analog Comparator Card	60
69775A Counter/Totalizer Card	60
69776A Interrupt Card	60
69790A Memory Card	60
69793A Breadboard Card	60
70000	
72021C HP-Plot/21 Software	694
80000	
82104A Card Reader (41C/CV) (Mar. 1980)	650
82106A Memory Module (41C/CV) (Mar. 1980)	649
82143A Printer/Plotter (41C/CV) (Mar. 1980)	650
82153A Optical Wand (41C/CV)	650
82170A Quad Memory Module (41C/CV)	649
82500A Custom Modules	651
82500B Custom Modules	651
82505A Custom Magnetic Cards	651
82901M Flexible Disc Memory	653, 674
82902M Flexible Disc Memory	653, 674
82903A 16K Memory Module (Series 80 Computers)	653
82905A Printer	655
82928A System Monitor	656
82929A Programmable ROM Drawer	656
82936A ROM Drawer	655
82949A Printer Interface	656
82937A HP-IB Interface Card (Jul. 1980)	34, 655
82939A Serial Interface Card	35, 655
82940A GPIO Interface Card	35, 655
82941A BCD Interface Card	35, 655
83522A 0.01-2.4 GHz RF Plug-In for 8350A	430
83525A 0.01-8.4 GHz RF Plug-In for 8350A	430
83540A 2-8.4 GHz RF Plug-In for 8350A	432
83545A 5.9-12.4 GHz RF Plug-In for 8350A	432

83570A 18-26.5 GHz RF Plug-In for 8350A 432
83590A 2-20 GHz RF Plug-In for 8350A 428
 83592A 0.01-20 GHz RF Plug-In for 8350A 428
83594A 2-26.5 GHz RF Plug-In for 8350A 428
83595A 0.01-26.5 GHz RF Plug-In for 8350A 428
 85010B Basic Measurement Program Pac
 for 8501A/8505A & 9825T 497
 85030B Applications Pac for 8507B-9825T 497
 85030C Applications Pac for 8507C-9845T 497
 85031A APC-7 Calibration and Verification
 Kit for 8507B 497
 85032A 50 Ω Type-N Calibration Kit 497, 507
 85033A SMA Calibration Kit 497, 507
 85033B APC-3.5 Calibration Kit 507
 85036A 75 Ω Type N Calibration Kit
 for 8507B 497
85650A Quasi-Peak Adapter 535
 85860A Software Pac for
 8568A/9825/9866B Opt. 025/98034A 534
85860B Software Pac for
8568A/9825T/9876A/98034B 534
 85861A Software Pac for
 8566A/9825/9866B Opt. 025/98034A 534
85861B Software Pac for
8566A/9825T/9876A/98034B 534
 86200 series Sweeper Plug-ins for 8620C 440
 86222A & B Sweeper Plug-ins for 8620C 437
 86240A/B/C Sweeper Plug-ins for 8620C 439
 86290A, 86290B & 86290C Broadband Sweeper
 Plug-ins for 8620C 438
 86600 series RF Section Plug-ins
 for 8660A & C 401
 86630 series Modulation Section Plug-ins
 for 8660 A & C 403

90000
 90100D Practical Transistor Series (Video Tape) 744
 90301RD Understanding Microprocessors (Video Tape) 742
 90420D Digital Troubleshooting (Video Tape) 743
 98032A 16-bit Parallel Interface 35
 98033A BCD Input Interface 35
 98034B HP-IB Interface 34
 98035A Real Time Clock Interface 35
 98036A Serial Interface 35
 98040A Incremental Plotter Interface 35
 98041A Disc Interface 35
98046B Intelligent Datacomm Interface 35
98620A Two Channel Interface 35
98622A 16-Bit Interface 35
98623A BCD Interface 35
98624A HP-IB Interface 34
98626A Serial Interface 35
 0960-0054 SMA-female short (50 ohm) 467
 0960-0055 SMA-male short (50 ohm) 467
 1250-0076 90° BNC Male-Female 713
 1250-0077 Type N Female to BNC Male 713
 1250-0080 BNC Female to Female 713
 1250-0082 Type N Male to BNC Male 713
 1250-0176 Type N Male to Type N Female 90° 713
 1250-0216 BNC Male to Male 713
 1250-0559 Type N Tee, 1 Male, 2 Female 713
 1250-0597 Adapter, 50 to 75-Ohm (for 8483A) 451
 1250-0777 Type N Female to Female 713
 1250-0778 Type N Male to Male 713
 1250-0780 Type N Male to BNC Female 713

1250-0781 BNC Tee 1 Male, 2 Female 713
 1250-0831 SMC Male to BNC Male 713
 1250-0832 SMC Female to BNC Female 713
 1250-0846 Type N Tee, 3 Female 713
 1250-1158 SMA Female to Female 713
 1250-1159 SMA Male to Male 713
 1250-1236 SMB Female to BNC Female 713
 1250-1250 N Male to SMA Female 713
 1250-1263 BNC Male to Single Banana Plug 713
 1250-1264 BNC Male to Dual Banana Plug 713
 1250-1286 Right Angle BNC (female) 713
 1250-1287 BNC (female) to (female) 713
 1250-1288 BNC (male) to (male) 713
 1250-1454 BNC Adapter Tip for HP Miniature Probes 713
 1250-1472 N (f) to N (f) Precision (50 Ω) 713
 1250-1473 N (m) to BNC (m) Precision (50 Ω) 713
 1250-1474 N (f) to BNC (f) Precision (50 Ω) 713
 1250-1475 N (m) to N (m) Precision (50 Ω) 713
 1250-1476 N (m) to BNC (f) Precision (50 Ω) 713
 1250-1477 N (f) to BNC (m) Precision (50 Ω) 713
 1250-1528 N (male to male) (75 Ω) 713
 1250-1529 N (f) to N (f) (75 Ω) 713
 1250-1530 N-Male Short (75 Ω) 467
 1250-1531 N-Female Short (75 Ω) 467
 1250-1533 N (m) to BNC (m) (75 Ω) 713
 1250-1534 N (f) to BNC (m) (75 Ω) 713
 1250-1535 N (m) to BNC (f) (75 Ω) 713
 1250-1536 N (f) to BNC (f) (75 Ω) 713
 1251-2277 Dual Banana plug to BNC Female 713
 1251-2816 Dual Banana plug (for cable) 713
 5060-0789 Cooling Kit 721
 5060-0796 Cooling Kit 721
 00085-15001 Mass Storage ROM 656
 00085-15002 Plotter/Printer ROM 656
 00085-15003 I/O ROM 656
 00085-15004 Matrix ROM 656
00085-15005 Advanced Programming ROM 656
00085-15007 Assembler ROM 656

*A monthly publication of technical information from the HP Laboratories.



HEWLETT-PACKARD INTERFACE BUS

Versatile Interconnect System for Instruments and Controllers



- A versatile interconnect system that links instruments, desktop computers, minicomputers, and peripheral devices into automated measurement systems
- Very broad selection of HP-IB compatible instruments and accessory devices
- Wide choice of computers for the reduction, analysis, storage and management of measurement systems and resulting data
- The hardware, documentation and support that delivers the shortest path to a measurement system



There are many applications where the measurement power of interactive instruments can be further enhanced by coupling them to desktop or minicomputers. Operating in a remote mode can provide more exact, error-corrected results as compared with conventional manual operation techniques.

Presently, three major parameters combine to reduce significantly the engineering development costs of configuring measurement systems:

- 1) The Hewlett-Packard Interface Bus, also known as "HP-IB";
- 2) Distributed computing through the growing number of "smart" instruments with internal microprocessors;
- 3) The broad choice of computers, ranging from "friendly" easy-to-program desktop computers to more sophisticated computer systems capable of managing multi-station instrument clusters and complex data bases.

Relationship Between HP-IB and Other Interface Standards

Hewlett-Packard historically has been committed to the overall advancement of measurement technology, and has for some time been working on the problems of simplifying and standardizing means of instrumentation interfacing. An example of such an effort is the intimate involvement with the HP-IB from its conception at HP to its pre-

sent status as a world instrumentation interface standard (IEEE 488-1978 and IEC 625-1).

In mid-1972, Hewlett-Packard began to participate in various international standardization bodies. The U.S. Advisory Committee, composed of diverse interests represented by both users and manufacturers, first established initial goals—and then adopted the interface concept utilized by the HP Interface Bus as an appropriate starting point. A draft document was subsequently written and evaluated by members of the Committee, and then submitted as the U.S. Proposal to the IEC (International Electrotechnical Commission) Working Group in the autumn of 1972. Since then, the interface definition has undergone a number of minor changes to accommodate various needs at the international level.

In September 1974, the parent technical committee, IEC TC76, approved the main interface draft document for a formal ballot among the member nations of the IEC. Balloting took place in 1976, and IEC recommendation 625-1 was adopted. The IEC recommendation, using a different connector, is totally compatible with the present definition of the HP-IB.

Meanwhile, the IEEE Standards Board approved IEEE Standard 488-1975 "Digital Interface for Programmable Instrumenta-

tion", first published in 1975 and again published in 1978 with minor editorial changes as IEEE Standard 488-1978. The IEEE standard is also fully compatible with the HP-IB. In January 1976, the American National Standards Institute adopted the IEEE Standard and published it as ANSI Standard MC 1.1.

The standardized interface concept is now well accepted. More than 1000 products, including more than 190 from HP, that use the HP-IB concepts articulated in IEEE 488 are today available from more than 170 manufacturers. As additional instrumentation interface standards evolve from the HP-IB, we will clearly indicate the relationship of the Hewlett-Packard Interface Bus to those standards—just as we have done with IEEE Standard 488, ANSI Standard MC 1.1 and IEC Publication 625-1.

Why the HP Interface Bus Name?

As the list of HP products available with the "new digital interface" grew, our customers sought a convenient way to identify those products having the interface capability. In response, in 1974 we adopted the name "Hewlett-Packard Interface Bus" or simply "HP-IB". We will continue to use the identifying name and this symbol:



Both will be used with appropriate HP products so that their interface capabilities may be readily identified.

The Hewlett-Packard Interface Bus fully complies with IEEE Standard 488. As such, it incorporates the mechanical, electrical and functional specifications of the Standard. A fourth and vital element of any interface system is the operational aspect of a product at both the human-machine interface and machine-machine interface at the HP-IB port. HP-IB capability provides additional user benefits that are beyond the scope of IEEE Standard 488. Typical user conveniences such as underscored program codes on the front panel of the instruments for easy programming, convenient data output formats, designed-in "Learn Mode" capabilities, complete support documentation in the form of programming and interfacing guides, application notes and operation manuals illustrate the added benefits for users of products with HP-IB capability.

Single Source Systems Approach

The decision to use a "system" instead of conventional manual methods must be based on an engineering evaluation of benefits versus costs. Among the many benefits associated with a systems approach:

- More consistent results in repeated measurements—a system is not subject to operator fatigue.
- Greater throughput because systems are generally faster.
- More thorough testing because system speed allows more parameters to be measured in a shorter time.
- Results expressed in engineering or scientific units, since many systems controllers are capable of on-line data manipulation.

- Greater accuracy because system errors can be measured automatically, stored and accounted for in the results.
- "Adaptive" data acquisition wherein a system can be programmed to branch to other measurements to help pinpoint when it senses an abnormal condition.
- Measurement results can be stored in computer memory or on hard copy.

It is our objective to facilitate the integration of instrumentation systems by providing users with instruments and computers designed for systems applications. Computers are designed with HP-IB options that allow easy hook-up to the bus and incorporate easy-to-use bus commands in their software. HP's policy when designing HP-IB compatible instruments is to eliminate interfacing ambiguities associated with controllers and instruments operating per the IEEE, ANSI and IEC standards by adopting consistent interface design guidelines.

Proper training on system components is very important for efficient utilization of any interface system. Therefore, we offer training at sales and service offices worldwide on HP desktop computers, computer systems and instruments as they relate to the HP-IB. (Refer to HP-IB Training, Page 27). In the area of HP-IB support documentation, we offer general interface technical descriptions, Operating and Service Manuals with programming information, Instrument/Controller Introductory Operating Guides, Quick Reference Guides and Application Notes. Technical assistance during system development is available from resident systems engineers specialized in desktop computers, computer systems and instruments at most local sales and service offices.

How the HP Interface Bus Operates

All active interface circuitry is contained within the various HP-IB devices, and the interconnecting cable (containing 16 signal lines) is entirely passive. The cable's role is limited to that of interconnecting all devices in parallel, whereby any one device may transfer data to one or more other participating devices.

Every participating device (instrument, controller, accessory module) must be able to perform at least one of the roles of TALKER, LISTENER or CONTROLLER. A TALKER can transmit data to other devices via the bus, and a LISTENER can receive data from other devices via the bus. Some devices can perform both roles (e.g., a programmable instrument can LISTEN to receive its control instructions and TALK to send its measurement).

A CONTROLLER manages the operation of the bus system primarily by designating which devices are to send and receive data, and it may also command specific actions within other devices.

A minimum HP-IB system configuration consists of one TALKER and LISTENER, without a CONTROLLER. In this configuration, data transfer is limited to direct transfer between one device manually set to "talk only" and one or more devices manually set to "listen only" (e.g., a measuring instrument

talking to a printer, for semi-automatic data logging).

The full flexibility and power of the HP-IB become more apparent, however, when one device which can serve as CONTROLLER/TALKER/LISTENER (e.g., calculator or computer) is interconnected with other devices which may be either TALKERS or LISTENERS, or both (e.g., frequency synthesizers, counters, power meters, relay actuators, displays, printers, etc.), depending on the application. An HP-IB controller participates in the measurement by being programmed to schedule measurement tasks, set up individual devices so that they can perform these tasks, monitor the progress of the measurement as it proceeds, and interpret the results of the measurement. HP offers controllers which can be programmed in higher level languages such as BASIC, FORTRAN, HPL, and PASCAL.

HP-IB Connections and Structure

The HP-IB has a party line structure where all devices on the bus are connected in parallel. The 16 signal lines within the passive interconnecting HP-IB cable are grouped into three clusters according to their function as follows:

- 1) Data Bus (8 signal lines)
- 2) Data Byte Transfer Control Bus (3 signal lines)
- 3) General Interface Management Bus (5 signal lines)

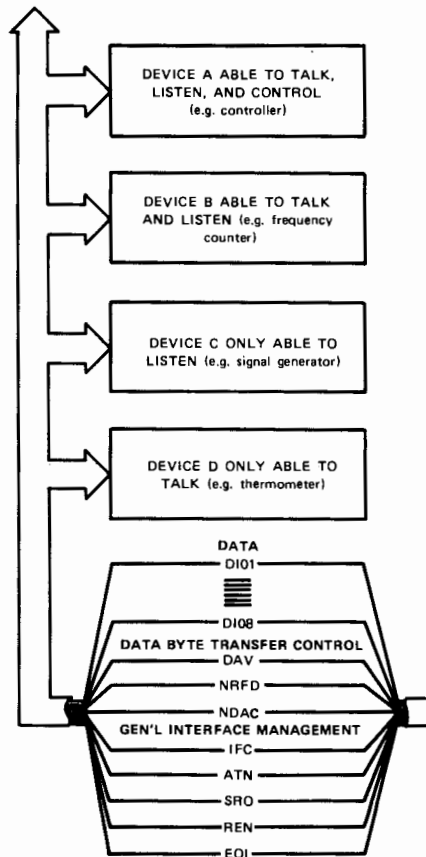

Interface connections and bus structure.

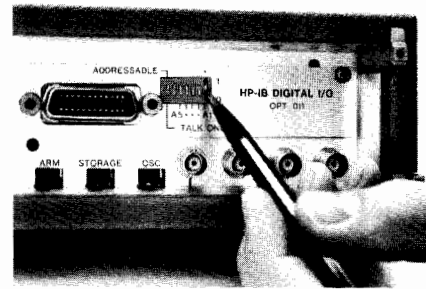

Rear panel switches are set so instrument will either be addressable by controller in a multi-device system, or will simply "talk only" to another device such as a printer.

The DATA BUS consists of eight signal lines which carry data in bit parallel, byte serial format across the interface. These signal lines carry addresses, program data, measurement data, universal commands and status bytes to and from devices interconnected in a system. Identification of the type of data present on the DIO signal lines is indicated by the ATN (attention) signal. When the ATN signal is true (asserted) either addresses or universal commands are present on the data bus and all connected devices are required to monitor the DIO lines. When the ATN message is false, then device dependent data (e.g., programming data) is carried between devices previously addressed to talk and listen.

Transfer of each byte on the Data Bus is accomplished via a set of three signal lines: DAV (data valid), NRFD (not ready for data), and NDAC (not data accepted). These signals operate in an interlocked handshake mode. Two signal lines, NRFD and NDAC, are each connected in a logical AND (wired OR) to all devices connected to the interface. The DAV signal is sent by the talker and received by potential listeners whereas the NRFD and NDAC signals are sent by potential listeners and received by the talker.

The General Interface Management Lines manage the bus to effect an orderly flow of messages. The IFC (interface clear) message places the interface system in a known quiescent state. SRQ (service request) is used by a device to indicate the need for attention or service and to request an interruption of the current sequence of events. REN (remote enable) is used to select between two alternate sources of device program data. EO1 (end or identify) is used to indicate the end of a multiple byte transfer sequence or, in conjunction with ATN, to execute a polling sequence.

It is not possible in this limited space to go into detail on each signal line's role. But you should note that every HP-IB device need not be able to respond to all the lines. As a practical and cost-effective matter, each HP-IB device will usually be designed to respond only to those lines that are pertinent to its typical function on the bus. (Details appear in each device's operation manual.)

HEWLETT-PACKARD INTERFACE BUS

Versatile Interconnect System for Instruments and Controllers



Individual Hewlett-Packard Products Available With HP-IB Capability

Products related to	Model	Product name/characteristics	See page	
Control and Computation	83A	Personal Computer	653	
	85A/F	Personal Computer (uses 82937A Interface)	653	
	9815S	Desktop Computer (uses 98135A Interface)	662	
	9825B/T	Desktop Computer (uses 98034B Interface)	662	
	9826A	Desktop Computer	658	
	9835A/B	Desktop Computer (uses 98034B Interface)	660	
	9845B/T	Desktop Computer System 45 (uses 98034B Interface)	661	
	9915A	Modular Computer	659	
	HP1000 E-series	Computers (2109E & 2113E; use 59310B Interface)	663	
	HP 1000 F-series	High-performance computers (2111F and 2117F use 59310B Interface)	663	
	HP1000 L-series	Low cost computer (2103L uses 12009A Interface)	663	
	3075A	Desktop Data Capture Terminal	673	
	3076A	Wall Mounted Data Capture Terminal	673	
	Stimulus	3320B Option 007	Frequency Synthesizer: 0.01 Hz to 13 MHz	384
3325A		Synthesizer/Function Generator/Sweeper: 1 μ Hz to 21 MHz	382	
3330B		Automatic Synthesizer/Sweeper: 0.1 Hz to 13 MHz	385	
3335A		Synthesizer/Level Generator: 200 Hz to 80 MHz	386, 630	
3336A/B/C		Synthesizer/Level Generator: 10 Hz to 20.9 MHz	388, 626	
4140B		PA Meter/DC Voltage Source	132	
5359A		Time Synthesizer: 1 ns accuracy; 50 ps increments, 100 ps jitter	356	
6002A Option 001		DC Power Supply: 200 W autoranging. Listen only	268	
6034A		System Power Supply: 200 W Autoranging w/ status-readback	266	
6129C Option J99		Digital Voltage Sources: \pm 50 Vdc at 5 A (requires 59301A Converter)	270	
6130C Option J99		Digital Voltage Source: \pm 50 Vdc at 1A (requires 59301A Converter)	270	
6131C Option J99		Digital Voltage Source: \pm 100 Vdc at 0.5 A (requires 59301A Converter)	270	
6140A Option J99		Digital Current Source: \pm 100 mA at 100 Vdc (requires 59301A Converter)	270	
6940B		Multiprogrammer (requires 59500A interface)	55	
6942A		Multiprogrammer	58	
8016A Option 001		Word Generator: 9 x 32 bit. Listen only	370	
8018A Option 001		Serial Data Generator: 50 MHz, 2048-bit memory. Listen only	367	
8116A		Programmable Pulse/Function Generator: 1 MHz to 50 MHz	353	
8160A		Programmable Pulse Generator: 20 ns to 999 ms period	350	
8161A		Programmable Pulse Generator: 10 ns to 980 ms period	350	
8165A		Programmable Signal Source: 0.001 Hz to 50 MHz	355	
8170A		Logic Pattern Generator: 8 x 1024/16 x 512 bit	368	
8350A		Sweep Oscillator: 10 MHz to 26.5 GHz	424	
8620C Option 011		Sweep Oscillator: 10 MHz to 22 GHz	436	
8656A		Signal Generator: 0.1 to 990 MHz	396	
8660A, C Option 005		Synthesized Signal Generators: 10 kHz to 2.6 GHz. Listen only	400	
8662A		Synthesized Signal Generator: 10 kHz to 1280 MHz.	398	
8671A		Microwave Frequency Synthesizer: 2 to 6.2 GHz	415	
8672A		Synthesized Signal Generator: 2 to 18 GHz	416	
Measurement		436A Option 022	Power Meter: -70 dBm to +44 dBm, to 26.5 GHz	448
		1602A Option 001	Logic State Analyzer: 64 x 16 bit memory	177-180
		1610A/B Option 003	Logic State Analyzer: 64 x 32 bit memory	173-176
	1615A Option 001	Logic Analyzer: 256 x 24 bit memory	170-172	
	1640B Option 001	Serial Data Analyzer: 2048 bit memory	608-611	
	1980A/B	Oscilloscope Measurement System: dc to 100 MHz	198	
	1980A/B Option 860	Digital Waveform Storage	198	
	2240A	Measurement & Control Subsystem	64	
	2250	Measurement & Control System	62	
	2804A Option 010	Quartz Thermometer: 0.05°C accuracy	708	
	3040A	Network Analyzer: 50 Hz to 13 MHz	483	
	3044A	Spectrum Analyzer: 10 Hz to 13 MHz	565	
	3437A	System Digital Voltmeter: high speed, 3 $\frac{1}{2}$ digits	98	
	3438A	Digital Voltmeter: low-cost, 3 $\frac{1}{2}$ digits	96	
	3455A	Digital Voltmeter: 5 $\frac{1}{2}$ or 6 $\frac{1}{2}$ digits, auto calibration	104	
	3456A	Digital Voltmeter: 3 $\frac{1}{2}$ to 6 $\frac{1}{2}$ digit voltmeter 1 nV sensitivity	100	
	3582A	2-channel Real Time (FFT) Spectrum Analyzer: 20 MHz to 25.6 kHz	560	
	3585A	Swept Spectrum Analyzer: 20 Hz to 40 MHz, 3 Hz BW, 0.4 dB amplitude accuracy	520	
	3586A/B/C	Selective Level Meter: 50 Hz to 32.5 MHz	523, 625	
	3717A	Wideband 70 MHz modem	638	
	3724/25/26A	Baseband Analyzer	639	
	3746A	32.5 MHz Selective Level Measuring Set: CCITT and Bell FDM Systems	618	
	3747A	90 MHz Selective Level Measuring Set: CCITT FDM systems	618	
	3747B	90 MHz Selective Level Measuring Set: Bell FDM systems	618	
	3771A Option 005	Data Line Analyzer: CCITT measurement standards	597	
	3771B Option 005	Data Line Analyzer: Bell measurement standards	597	
	3779C	Primary Multiplex Analyzer: CEPT 2 Mb/s PCM systems	584	
	3779D	Primary Multiplex Analyzer: Bell 1.5 Mb/s PCM systems	584	
	3781A/3782A	Pattern Generator/Error Detector: CEPT and CCITT PCM/TDM systems	588	
	3781B/3782B	Pattern Generator/Error Detector: Bell PCM/TDM systems	589	
	3785A	Jitter Generator and Receiver: CEPT PCM/TDM systems	590	
	3785B	Jitter Generator and Receiver: Bell PCM/TDM systems	590	
	3850A	Industrial Distance Meter	701	
	4140B	PA Meter/DC Voltage Source	132	
	4191A	RF Impedance Analyzer	114	
	4192A	LF Impedance Analyzer	116	
	4193A	Vector Impedance Meter	118	
	4262A Option 101	Automatic LCR Meter	122	
	4271B Option 101	1 MHz Digital LCR Meter	124	
	4274A	Multifrequency LCR Meter: 10 steps, 100 Hz to 100 kHz	110	
	4275A	Multifrequency LCR Meter: 10 steps, 10 kHz to 10 MHz	110	
	4943A Option 010	Transmission Impairment Measurement System (TIMS)	605	
	4944A Option 010	Transmission Impairment Measurement System (TIMS)	605	
	5312A	HP-IB interface (Talker) for 5300B Counter System	346	
	5316A	Universal Counter: 0-100 MHz	338	
	5328A Option 011	Universal Counter: to 512 MHz, 10 ns time interval	334	
	5335A	Automatic Universal Counter: 200 MHz/1.3 GHz, 2ns Time Interval	332	



HEWLETT-PACKARD INTERFACE BUS

Versatile Interconnect System for Instruments and Controllers

Individual Hewlett-Packard Products Available with HP-IB Capability (Cont.)

Products related to	Model	Product name/characteristics	See page	
Measurement (Cont.)	5340A Option 011	Automatic Microwave Counter: 10 Hz to 18 GHz	326	
	5342A Option 011	Automatic Microwave Counter: 10 Hz to 18 GHz	324	
	5343A Option 011	Microwave Frequency Counter: 10 Hz to 26.5 GHz	324	
	5345A Option 011, 012	General Purpose Plug-In Counter	318	
	5353A Option 011	Channel C Plug-in for 5345A	318	
	5354A Option 011	4 GHz Frequency Converter for 5345A/5356A	318	
	5355A	Automatic Frequency Converter plug-in for 5345A	322	
	5363B	Time Interval Probes	330	
	5370A	Time Interval Counter: ± 20 ps single-shot resolution	328	
	5420A	Digital Signal Analyzer	568	
	5423A	Structural Dynamics Analyzer	568	
	5501A Option 251	Laser Transducer: for accurate positioning measurements	705	
	6940B	Multiprogrammer (requires 59500 interface)	31	
	6942A	Multiprogrammer II (no interface required)	31	
	8501A	Storage Normalizer for 8505A RF network analyzer	493	
	8503A & 8503B	S-Parameter Test Set: 50 or 75 Ohm, for 8505A	494	
	8505A	RF Network Analyzer: 500 kHz to 1.3 GHz	490	
	8566A	Spectrum Analyzer: 100 Hz to 40 GHz	526, 531	
	8568A	Spectrum Analyzer: 100 Hz to 1.5 GHz	526, 528	
	8569A	Spectrum Analyzer: 10 MHz to 40 GHz	536	
	8755P	Automatic Scaler Network Analyzer: 40 MHz to 18 GHz	476	
	8901A	Modulation Analyzer: 150 kHz to 1.3 GHz	578	
	8903A	Audio Analyzer: 20 Hz to 100 KHz	581	
	85650A	Quasi-Peak Adapter	535	
	Switching Scanning Translation or Timing	2240A	Measurement and Control Subsystem	64
		2250	Measurement and Control Subsystem	62
		3495A	Scanner: to 80 channels, low thermal; (up to 40 relay channels)	53
		3497A	Data Acquisition Control Unit	48
		3754A	25 MHz Access Switch (requires 3755A switch controller)	620
		3756A	90 MHz Switch (requires 3755A)	620
3757A		8.5 MHz Access Switch (requires 3755A)	620	
3777A		Telecommunications Channel Selector: up to 30 channels; dc to 110 kHz	585	
6940B		Multiprogrammer (requires 59500A interface)	55	
6942A		Multiprogrammer (no interface required)	58	
9411A		Switch Controller	665	
9412A		Modular Switch (requires 9411A switch controller)	665	
9413A		VHF Switch (requires 9411A)	665	
9414A		Matrix Switch (requires 9411A)	665	
11713A		Attenuator/Switch Driver (controls coax switches and step attenuators)	460	
37201A		HP-IB Extender Twisted-Pair or Modems	32	
37203A/L		HP-IB Extender: Coax and Fiber Optics	33	
59301A		ASCII-to-Parallel Converter: string to 16 characters	28	
59303A		Digital-to-Analog Converter	28	
59306A		Relay Actuator: for programmable switches, attenuators	28	
59307A		VHF Switch: two 50 Ohm, bidirectional, dc to 500 MHz	28	
59308A		Timing Generator	28	
59309A		Digital Clock: month, day, hour, minute, second	28	
59313A		Analog-to-Digital Converter	28	
59403A		HP-IB Common Carrier Interface: RS232C or CCITT V.24	31	
59501A		Power Supply Programmer: isolated D-to-A converter ± 10 V dc at 10 mA	29, 269	
Storage		3964A Option 007	Instrumentation Tape Recorder: 4 channel Listen only	301
	3968A Option 007	Instrumentation Tape Recorder: 8 channel Listen only	301	
	9895A	Flexible Disc Memory (8"): up to 2.36 M bytes of mass storage	674	
	82901M	Flexible Disc Memory (5¼"): up to 540 K bytes of random access storage	674	
	Data Entry, Displays	1350S, 1351S	Graphics Display Systems	243
2608A		Line Printer: 400 lines/minute dot matrix	682	
2631B		Alphanumeric Dot Matrix Impact Printer: 132 columns	677	
2631G		Graphics Dot Matrix Impact Printer: 132 columns	677	
2671A		Alphanumeric Thermal Printer: 80 columns	676	
2671G		Graphics Thermal Printer: 80 columns	676	
2673A		Intelligent Graphics Printer: 80 columns	676	
5150A Option 001		Alphanumeric Thermal Printer: 20 Columns. Listen only	303	
9871A Option 001		Character-Impact Printer: 132 columns	675	
7225B		Graphic Plotter: ISO A4 and 8½ x 11 inch chart size	688	
7245B		Thermal Plotter/Printer: Vector graphics, matrix printing	693	
9111A		Graphics Tablet: graphics input	656, 692	
7580A		Large Format Drafting Plotter	690	
9872C, 9872T		Graphics Plotter: multicolor (4 colors) programmable	686	
9874A		Digitizer: simplifies digitizing maps, drawings, other graphics	692	
9876A		Thermal Graphics printer: 480 lines-per-minute	675	
Interface Cabling	10833A	HP-IB Interconnection Cable: 1 m (3.3 ft)	30	
	10833B	HP-IB Interconnection Cable: 2 m (6.6 ft)	30	
	10833C	HP-IB Interconnection Cable: 4 m (13.2 ft)	30	
	10833D	HP-IB Interconnection Cable: 0.5 m (1.6 ft)	30	
	10834A	HP-IB Interconnection Cable Adapter: 2.3 cm (.91 in)	30	
HP-IB Extension	37201A	HP-IB Extender: Twisted Pair or modems	32	
	37203A/L	HP-IB Extender: Coaxial or Fiber Optic Cable	33	
	59403A	HP-IB Common Carrier Interface	31	
Design and Servicing	10050A	HP-IB adapter for 1602A Logic State Analyzer	179	
	10051A	Test Probe for 1602A Logic State Analyzer	179	
	10066A	Probe Interface for 1610A/B and 1615 A Logic State Analyzers	191	
	59401A	Bus System Analyzer	30	

Standard HP-IB Measurement Systems

Many application requirements can be satisfied with a standard HP-IB measurement system — a system assembled, tested, and

documented by Hewlett-Packard. Preconfigured systems save you design and setup time, and HP guarantees overall specified

system performance. Installation and service contracts are available from your local HP Sales and Service Office.

Standard HP-IB Measurement Systems (HP Built)

Application	Model	Controller	System name/characteristic	See page
Data Logging, Acquisition, and Control	3054A	85/9825/9826 9835/9845	Fast, flexible, and precise data acquisition system with a wide choice of controllers	42
	3054C	1000	Computer based automatic data acquisition/control system	45
	3054DL	85	Complete data logger	46
	5391A	9825	Frequency and Time Data Acquisition Systems: over 50,000 four-digit frequency and time interval measurements per second	327
	9030	9825/35/45	Measurement and Control System: Fully configured, self-contained, and easy to use portable laboratory or production system for computational measurement and control	64
Network Analysis	3042A	9825	Automatic Network Analyzer: complete amplitude and phase characterization, 50 Hz to 13 MHz. Group delay optional.	484
	8408A	85	Automatic Network Analyzer: 500 MHz to 18 GHz	498
	8409C	9845/9826	Automatic Microwave Analyzer: measures transmission and reflection parameters, 110 MHz to 18 GHz.	511
	8507B/C/D	9825/9826/9845	Automatic RF Network Analyzers: measures complex impedance, transfer functions, group delay; 500 kHz to 1.3 GHz.	496
	8755P	85	Automatic Scalar Network Analyzer: measures insertion and return loss, 40 MHz to 18 GHz	472
Spectrum Analysis	3045A	9825	Automatic Spectrum Analyzer: same as 3044A, and includes the faster 9825 as computing controller.	565
	8581B	9825	Automatic Spectrum Analyzer: covers 100 Hz to 1.5 GHz; exceptional frequency tuning accuracy and resolution.	534
	8582B	9825	Automatic Spectrum Analyzer: covers 100 Hz to 22 GHz; exceptional frequency tuning accuracy and resolution.	534
Frequency Stability Analysis	5390A	9825	Frequency Stability Analyzer: short and long-term characterization of precision frequency sources, 500 kHz to 18 GHz.	572
Transceiver Testing	8950B	9825	Automatic Transceiver Test System: for AM and FM transceivers, to 1000 MHz, transmitters to 100 W.	642
	8903A-E85	85	Semi-Automatic Transceiver Test Set. For AM and FM transceivers, 150 kHz to 990 MHz.	643
Circuit Testing	DTS-70	1000	Digital Test System: fast, accurate fault location on loaded printed circuit boards.	142
	3060A	9825	Analog and Digital Test System: Fast, accurate fault location on loaded printed circuit boards. Option 100 test microprocessors	143
Digital IC Testing	5046A	9825	Digital IC Test System: Reduces production costs through the isolation of faulty components prior to printed circuit board loading.	138
FDM Network Surveillance	3046A/B	85	Frequency Division Multiplex (FDM) network surveillance system: automatic capability based on HP-85	628
Semiconductor/Component Testing	4061A	9835/45 1000	Semiconductor/Component Test System: evaluation of fundamental characteristics of semiconductor and electronic components (I-V, HF, C-V, + quasi static C-V)	133
Pressure Recording	2820B	9825	Pressure recording system: displays, prints, and records pressure test data from oil and gas wells. Used with the 2813B Quartz Pressure Probe.	707
Dimensional Inspection	3822A	9845	Coordinate Determination System for dimensioning large objects in industrial environments	702

HP-IB Training and Support Available from Hewlett-Packard

Hewlett-Packard has field sales people trained in electronic instruments, desktop computers and computer systems to assist you in configuring HP-IB measurement systems. Also available for technical consultation are computing controller systems engineers and HP-IB instrumentation specialists.

HP-IB training courses on HP-IB controllers and instruments are listed below. Courses are conducted at selected Hewlett-Packard locations. For specific information on schedules and locations, contact your nearest HP office.

Computer Systems

Course Name	Duration
• Instrument Interface with HP-IB	4 days

Desktop Computer Systems

Course Name	Duration
• BASIC Language Programming for Desktop Computers	4 days
• 9825 Operating and Programming	5 days
• 9825 I/O Programming	4 days
• 9835 Assembly Language Programming	5 days
• 9845 Operating and Programming	5 days
• 9845 BASIC Language I/O Programming	4 days
• 9845 Image Data Base Management	5 days
• 9845 Color Graphics Operating and Programming	5 days

Service and Warranty Considerations

Hewlett-Packard has dedicated measurement system service people who perform on-site maintenance on both customer configured systems as well as HP configured systems, irrespective of whether an HP desktop or minicomputer is used. Service contract coverage is available to meet your specific measurement system service needs and can be tailored to include extended warranty, calibration and extended hours of coverage. Contact your local sales and service office for further information on HP-IB service contract information.

Every HP-IB device and HP configured system carries a standard Hewlett-Packard warranty appropriate to that product. The warranty period for each product will be provided on request at the time of sale and is specified in documentation supplied with the product. HP takes responsibility for standard HP-IB systems performing as specified. However, software or interfacing which has not been provided by Hewlett-Packard as part of a standard system delivered by HP is not covered by this warranty.

In all cases, overall operational responsibility for those HP-IB systems assembled by a customer from individual HP-IB devices shall rest with the customer.

HP-IB Specifications Summary

Interconnect Devices

Up to 15 maximum on one contiguous bus.

Interconnection Path

Star or linear bus network; total transmission path length 2 metres times number of devices or 20 metres, whichever is less. Operating distances can be extended; see pages 31, 32, and 33.

Message Transfer Scheme

Byte-serial, bit-parallel asynchronous data transfer using locked 3-wire handshake technique.

Data Rate

One megabyte per second maximum over limited distance; 250-500 kilobytes per second typical over full transmission path (actual data rate depends on individual device characteristics).

Address Capability

Primary addresses, 31 TALK and 31 LISTEN; secondary (2-byte) addresses, 961 TALK and 961 LISTEN. Maximum of 1 TALKER and up to 14 LISTENERS at a time.

Control Shift

In systems with more than one controller, only one can be active at a time. A currently active controller can pass control to another, but only designated system controller can assume control over others.

Interface Circuits

Driver and receiver circuits are TTL-compatible.

Connector Lock Screw Compatibility

HP-IB products delivered now and in recent years are equipped with connectors having ISO metric-threaded lock screws, and stud mounts. (Very early HP-IB products have non-metric parts, but are readily distinguished from the metric by color: metric threaded parts are black and stamped with the letter "M" whereas non-metric parts have a shiny nickel finish). HP-IB Metric Conversion Kit (P/N 5060-0138) is available to convert these early instruments.

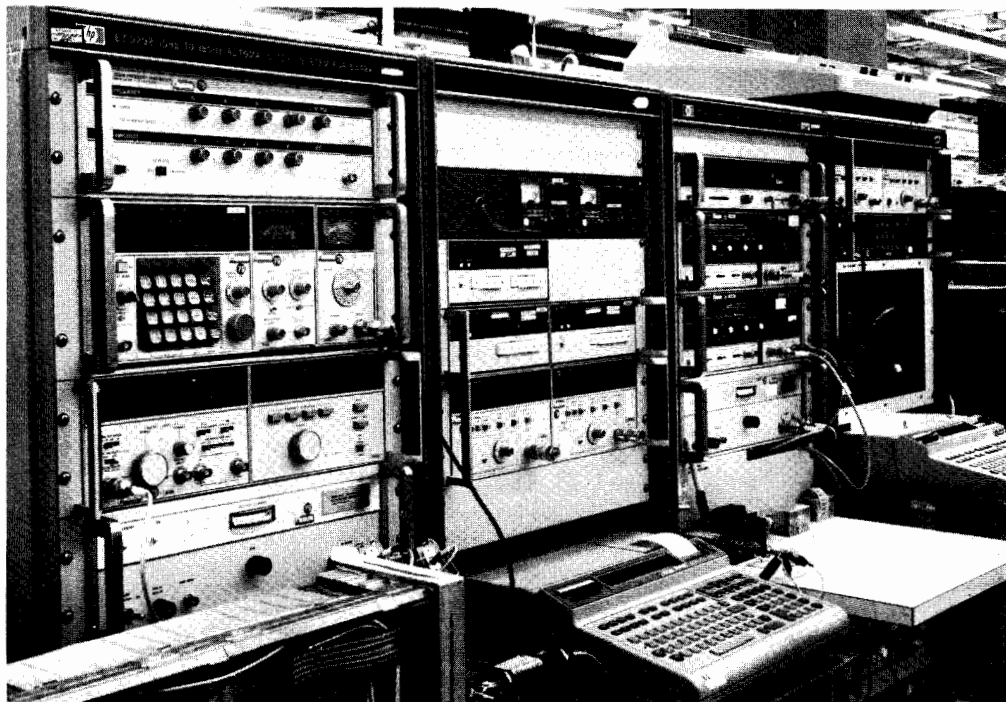

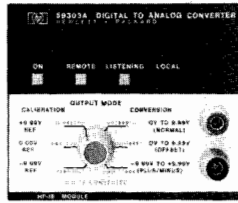

59303A

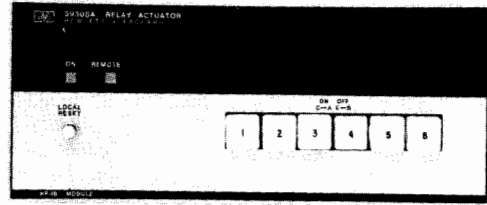

59306A

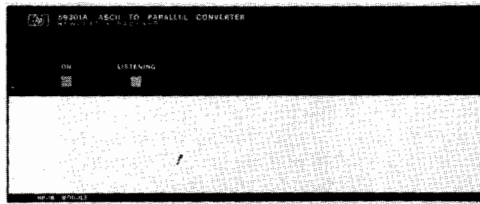

59301A

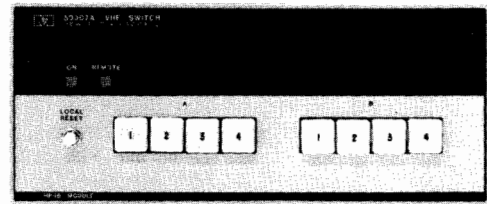

59307A

HP-IB Accessory Modules

Modules in the HP 59300, 59400 and 59500-series are ideal building blocks for use with instruments to extend measurement capabilities. Modules listed here can be interconnected via the HP-IB to HP measuring instruments, signal sources and recording devices capable of operating directly on the HP-IB. In addition, these modules frequently serve as useful ways to interconnect with devices which are not themselves capable of direct HP-IB operation.

Instrument requirements differ. Some only output or accept data on the HP-IB. Others can be remotely programmed by ASCII characters sent along the HP-IB. These modules can work with instruments on any of these levels with or without a controller. Each module having controls can be operated stand-alone from its front panel, or it can be placed in automatic operation under program control.

Module provision for stand-alone, local operation also has important system benefits. The operator can set up and check out the system under manual control, avoiding otherwise complex and time consuming error tracing. Each module has status indicator lights that make it easy to monitor operation.

59301A ASCII-to-Parallel Converter

Accepts byte-serial ASCII characters from the HP-IB and converts them to parallel output. In operation, ASCII characters transmitted serially along the bus are converted into 4-bit characters with the first ASCII character received being interpreted as the most significant digit. A string of up to 16 characters terminated by linefeed is converted and placed upon the output lines. The linefeed character causes the 59301A to output a print command (strobe).

With the 59301A, instruments controlled via BCD can be operated using HP-IB. For example, the 59301A can be used with HP 6129C through 6131C and 6140A (Option J99) digitally-controlled power supplies for HP-IB programmable voltage and current. The 59301A can additionally be used to control other functions using its hexadecimal format.

General

Size: 101.6 mm H¹ x 212.9 mm W x 294.6 mm D (4" x 8.38" x 11.6")
Weight: Net 1.70 kg (3.78 lb), Shipping 2.33 kg (5.16 lb)

59301A ASCII-to-Parallel Converter \$675

59303A Digital-to-Analog Converter

Accepts a string of serial ASCII characters and converts any three consecutive input digits to an analog output voltage, accurate to 0.1% in 30 μ s. Fully programmable via the HP-IB or manually operated from the front panel. A concentric control on the front panel makes it easy to select the digit group for conversion and the output mode. The

¹Height includes feet. With feet removed height is 88.1 mm (3.45").

conversion switch is used to select the three digits of the character string that the DAC will change into analog voltage. The three output modes (NORMAL, OFFSET, and PLUS/MINUS) make the converter convenient for use directly with a variety of data logging devices, avoiding the need for auxiliary equipment to shift zero level or change polarity.

A primary application for the HP 59303A is to present on a logging device the data points being taken with a measuring instrument (like a frequency counter). A controller is not required for operation. Compatible logging devices include strip chart recorders, X-Y plotters, and displays.

General

Size: 101.6 mm H¹ x 105.9 mm W x 294.6 mm D (4" x 4.17" x 11.6")
Weight: Net 2.61 kg (5.80 lb), Shipping 3.17 kg (7.04 lb)

59303A Digital-To-Analog Converter \$1300

59306A Relay Actuator

Has six Form-C relays that provide for control of external devices either manually from front panel pushbuttons or remotely from the HP-IB. Relay contacts are specified to switch 24 V dc or 115 V ac at 0.5 A. Each relay can be programmed independently or multiple relays can be switched together. Front panel pushbuttons light to indicate the state of each relay.

The 59306A is ideal for providing control of microwave coaxial switches (HP 8761 A/B) as well as control of microwave programmable step attenuators (HP 8494 through 8496 G/H) using external dc power supplies.

General

Size: 101.6 mm H¹ x 212.9 mm W x 294.6 mm D (4" x 8.38" x 11.6")
Weight: Net 2.64 kg (5.87 lb), Shipping 3.23 kg (7.18 lb)

59306A Relay Actuator \$875

59307A Dual VHF Switch

This module provides two single throw 4-pole switches controlled from front panel pushbuttons or remotely from the HP-IB. The 59307A is a dc to 500 MHz 50 Ω switch designed to maintain fast pulse transition times. The switches are independent and bidirectional for optimum use in multiplexing 50 Ω signal lines into measuring instruments. The 59307A is ideal to switch a standard delay, frequency, or voltage into a measurement loop for purposes of system calibration.

General

Size: 101.6 mm H¹ x 212.9 mm W x 294.6 mm D (4" x 8.38" x 11.6")
Weight: Net 2.64 kg (5.87 lb), Shipping 3.23 kg (7.18 lb)

59307A VHF Switch \$900

HEWLETT-PACKARD INTERFACE BUS

Versatile Interconnect System for Instruments and Controllers

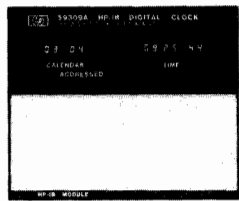

59309A

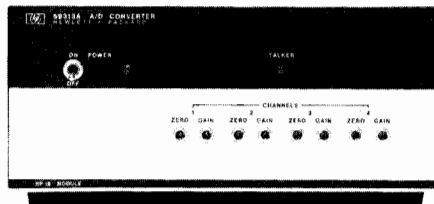

59313A

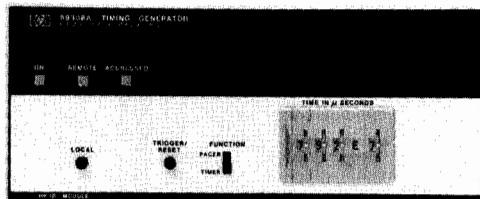

59308A

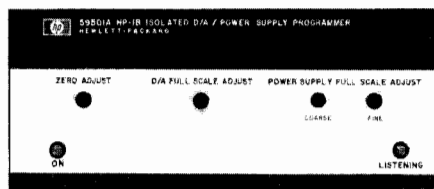

59501A

59308A Timing Generator

Provides a timing reference as either a Timer (digital delay generator) or a Pacer (precision time marker generator). In the Timer mode, a timing pulse is provided at a specified interval after a trigger is received. In the Pacer mode, a train of timing pulses of a specified period is provided on and after the receipt of a trigger.

The timing pulses are output on rear-panel BNC connectors and signal the HP-IB with appropriate signals. The timing can be set via the front panel thumbwheel switches, or via HP-IB. Times from 1 μ s to more than a day are available. Trigger inputs are available via HP-IB commands and rear panel connector. Outputs are available from both TTL and ECL levels, with switch selection of a squarewave or pulse output positive- or negative-going edge. Output pulses are 500 ns \pm 100 ns wide, and rise time is <50 ns into 50 Ω .

General

Size: 101.6 mm H¹ x 105.9 mm W x 294.6 mm D (4" x 4.17" x 11.6")

Weight: Net 1.70 kg (3.78 lb), Shipping 2.84 kg (6.31 lb)

59308A Timing Generator

\$1325

59309A HP-IB Digital Clock

Displays month, day, hour, minute, and second, and upon command will output time via the interface bus. Time can be set into the clock by local control, or by remote commands received from the HP-IB. The clock accepts a small internal battery which can provide more than a day's standby in case of short power interruptions. Additionally, an auxiliary power supply such as the K10-59992 can sustain the clock for up to one year.

General

Size: 101.6 mm H¹ x 105.9 mm W x 294.6 mm D (4" x 4.17" x 11.6")

Weight: Net 1.70 kg (3.78 lb), Shipping 2.84 kg (6.31 lb)

59309A HP-IB Digital Clock

\$1200

¹Height includes feet. With feet removed height is 88.1 mm (3.45").

59313A Analog-to-Digital Converter

Four channel converter allows analog data with a full scale range of up to \pm 10V dc to be digitized and transmitted via HP-IB to a computing controller.

On command from the controller, the instrument can be programmed to perform a single conversion or a series of internally-paced conversions in six selectable rates of up to 200 per second on one channel, or up to 50 per second on each of four channels. Sampling can also be initiated externally by a TTL transition or contact closure to ground. Included is a program-controlled reverse channel capable of driving small lamps, relays or TTL devices.

General

Size: 101.6 mm H¹ x 212.9 mm W x 345.4 mm D (4" x 8.38" x 13.6")

Weight: Net 5.45 kg (12.0 lb), Shipping 6.36 kg (14.0 lb)

59313A Analog-to-Digital Converter

\$2150

59501A Power Supply Programmer (Isolated DAC)

This single-channel digital-to-analog converter can control a wide range of power supplies (output voltage, or current), as well as other analog programmable devices. It may also be used as a low level signal source, depending on the speed of the controller. It has two output ranges (0-1 and 0-10V dc in unipolar mode; -1 to +1 and -10 to +10 V dc in bipolar mode), as well as photo-isolators which electrically separate HP-IB control and data lines from power supply circuitry by up to 600 V dc. (Additional details on page 269)

General

Size: 101.6 mm H¹ x 212.9 mm W x 194.6 mm D (4" x 8.38" x 11.6")

Weight: Net 2.61 kg (5.80 lb), Shipping 3.17 kg (7.04 lb)

59501A Power Supply Programmer

\$700

Model	Description	Dimensions—max. height x width x depth mm (inches)	Net Weight kg (lb)	Shipping Weight kg (lb)	Price
59301A	ASCII-to-Parallel Converter	101.6 x 212.9 x 294.6 (4 x 8.38 x 11.6)	1.70 (3.78)	2.32 (5.16)	\$ 675
59303A	Digital-to-Analog Converter	101.6 x 105.9 x 294.6 (4 x 4.17 x 11.6)	2.61 (5.80)	3.17 (7.04)	\$1300
59306A	Relay Actuator	101.6 x 212.9 x 294.6 (4 x 8.38 x 11.6)	2.64 (5.87)	3.23 (7.18)	\$ 875
59307A	VHF Switch	101.6 x 212.9 x 294.6 (4 x 8.38 x 11.6)	2.64 (5.87)	3.23 (7.18)	\$ 900
59308A	Timing Generator	101.6 x 212.9 x 294.6 (4 x 8.38 x 11.6)	2.10 (4.67)	3.83 (8.51)	\$1325
59309A	HP-IB Digital Clock	101.6 x 105.9 x 294.6 (4 x 4.17 x 11.6)	1.70 (3.78)	2.84 (6.31)	\$1200
59313A	Analog-to-Digital Converter	101.6 x 212.9 x 345.4 (4 x 8.38 x 13.6)	5.45 (12.0)	6.36 (14.0)	\$2150
59401A	Bus System Analyzer	145.5 x 205.1 x 495.3 (5.73 x 8.08 x 19.5)	5.64 (12.44)	9.1 (20)	\$3100
59403A	HP-IB/Common Carrier Interface	101.6 x 212.9 x 430.0 (4 x 8.38 x 16.9)	4.50 (10.0)	6.10 (13.5)	\$2100
59501A	Power Supply Programmer	101.6 x 212.9 x 294.6 (4 x 8.38 x 11.6)	2.61 (5.80)	3.17 (7.04)	\$ 700

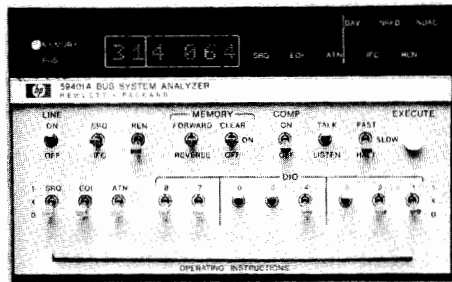

59401A

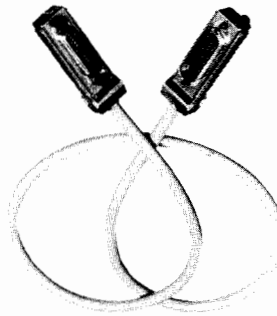

10833A/B/C/D

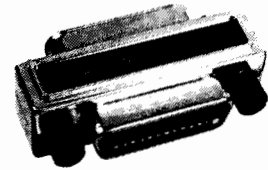

10834A

59401A Bus System Analyzer

The HP-IB (IEEE 488) concept has greatly simplified many of those things which have in the past made instrument interfacing a burdensome task. Even so, software errors can occur if the system designer does not completely understand the bus system or the capabilities of the instruments and other devices being interfaced. Hardware problems can occur if the instruments/devices are not functioning properly, or if they are not completely compatible with the bus standard.

The 59401 Bus System Analyzer is especially useful in design and service work. It simplifies and speeds up the diagnosis of software and hardware problems by allowing the user to see the status of all bus lines, including the actual characters on the bus data lines. Because the 59401A can also drive all bus lines, it can completely exercise another Talker, Listener or Controller—which is especially useful in verifying compatibility of new or user-designed products with the HP-IB.

There are several choices of analyzer operating speed. It may be operated at one character at a time (useful for software debugging), at 2 characters per second, or at regular bus speed. It may also be operated at a variable rate as determined by the external clock input.

The analyzer's 32 character memory can be used to store bus characters in the Listen mode, or to output characters to the bus in the Talk mode. When the analyzer is in the Compare mode, a stream of bus traffic may be stopped on a pre-selected character—and at that time, a trigger pulse is available, which is very useful when analyzing transient or timing problems related to the bus.

59401A Specifications

Display: monitors all bus lines. Represents data lines, any memory location, or DIO front panel switch settings; in octal code and ASCII character.

Listen mode: stores up to 32 characters of bus traffic in memory for real time and repetitive testing. In Compare mode, halts bus traffic when a selected character is present, and user can display any one of the previous 31 characters stored in memory.

Timing: accept <750 ns; ready <750 ns.

Talk mode: bus lines can be driven directly from front panel switches; memory can be loaded from front panel switches for driving bus with a 32 character sequence.

Timing: (1) data changed >500 ns before DAV pulled low; (2) ATN driven low >1 μs before DAV pulled low; (3) DAV driven high <700 ns after NDAC is false; (4) DAV driven low <700 ns after NRFD is false, if conditions 1 and 2 are met.

Operating speeds: one character at a time, 2 characters per second, regular bus speed, or variable rate determined by external clock input; in either Listen or Talk mode.

External clock input: 1 standard power TTL gate input; ≤10 MHz repetition rate.

Compare output: provides 1 standard power TTL gate output (LOW TRUE) sync pulse when bus character is same as front panel switches.

HP-IB load: 1 bus load (capable of driving 14 other bus devices).

General

Temperature ranges: operating, 0 to 50°C; storage, -40 to +75°C.

Humidity: 95% relative, 0 to 40°C.

Power requirements: 100, 120, 220, or 240 V +5%, -10%; 48 to 66 Hz; ≤42 VA.

Size: 145.5 H, 205.1 W, 495.3 mm D (5.730" x 8.075" x 19.500")

Weight: net, 5.64 kg (12.44 lb).

Options and Accessories

5061-0089 front handle kit
10631B 2 m (6.6 ft) bus cable, furnished

Price
\$32
N/C

59401A Bus System Analyzer

\$3300

HP-IB Interconnection Cables

Cables for interconnecting HP-IB devices are available in four different lengths. The connector block at both ends of each HP-IB cable (photo above) has a plug on one side and a matching receptacle on the other, so that several cables may be conveniently connected in parallel, thus simplifying system interconnection. Lock screws provide for secure mounting of each connector block to an HP-IB instrument, or to another cable connector block.

SPECIAL NOTE: HP-IB cables are not always included with individual HP-IB devices, particularly those that normally connect directly to an HP computing controller. (The HP-IB interface for HP computing controllers contains the necessary cable and connector). Product listings in this catalog should be checked to see if HP-IB cables are furnished.

The 10833 series of cables feature an improved shielding design to help improve RFI levels in systems. This series of cables, with the RFI shielding, exhibits significantly lower radiated emissions than previous HP-IB cables. They are also completely compatible with the 10631 cable series.

The 10834A adapter is a shielded HP-IB to HP-IB adapter. It provides additional clearance between the HP-IB cable and the rear panel of the instrument. This allows easier access to switches, cables, and other connectors that may be in close proximity to the HP-IB connector.

Ordering Information

10833A HP-IB Cable, 1m (3.3 ft)
10833B HP-IB Cable, 2m (6.6 ft)
10833C HP-IB Cable, 4m (13.2 ft)
10833D HP-IB Cable, 0.5m (1.6 ft)
10834A Adapter

Price
\$70
\$75
\$85
\$70
\$20

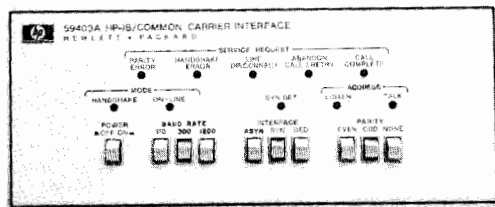

59403A

HP-IB Operating Range

A fundamental limitation which applies to all devices designed to comply with IEEE Standard 488 is that the maximum cumulative length of HP-IB cable in any system should not exceed 2 metres of cable per device, or 20 metres, whichever is less.

However, for many applications, there is a requirement to interconnect HP-IB devices at sites separated by several hundred metres or even thousands of miles. Hewlett-Packard has developed several products which allow the HP-IB operating range to be extended, using twisted pair cable, coaxial cable, fiber optics or the telephone network.

Product	59403A Common Carrier Interface	37201A HP-IB Extender	37203A HP-IB Extender
Application	General purpose: inter/intra facility	General purpose: inter/intra facility	Fast: intra facility
Transmission Medium	Dual twisted pair or modem link	Dual twisted pair or modem link	Single coax or dual fiber optic cable
Operating Range	Twisted pair: 1000 metres; Modem link: unlimited	Twisted pair: 1000 metres; Modem link: unlimited	1000 metres
Modem Data Rates	Asynchronous: 110/300/1200 bits/s	Asynchronous: 150/300/600/1200 bits/s; Synchronous: up to 19200 bits/s	—
Hardwired Speed	1760 bytes/s	775 bytes/s	Up to 50k bytes/s
Error Checking	Parity only, no retransmission	Block check with auto retransmission	Cyclic redundancy check
Electrical Noise Isolation	—	Balanced coupling on hardwired links	Fiber optic or opto-isolated coax
Programming Transparency	No	Yes, except Parallel Poll and Pass Control	Yes, including Parallel Poll and Pass Control

59403A HP-IB/Common Carrier Interface

Provides a way to extend the separation of component parts in an HP-IB system by more than the 20-metre maximum transmission path length specified in various interface standards, and it is especially useful for production or remote site applications. Distances up to 1000 metres are possible by using two 59403A modules (one at each location) interconnected by a dedicated and shielded two-twisted-pair cable. And even longer distances can be achieved by using a telephone line (with appropriate modems) instead of the dedicated cable.

The recommended dedicated cable is available from HP as Part Number 8120-1197 (Belden type 8723). The 59403A is designed to operate with 110, 300, and 1200 baud asynchronous or synchronous full duplex modems which are EIA RS 232C or CCITT V.24 compatible. In the U.S., Bell 103A modems with "soft carrier turn-off" are recommended for the direct dial (DDD) network. (Check your local telephone authorities regarding data communication regulations.)

59403A HP-IB/Common Carrier Interface **\$2250**

With a Multiprogrammer
Your HP Desktop or Minicomputer Becomes a Reliable
Easy-to-use Automatic Test or Control System



MULTIPROGRAMMER

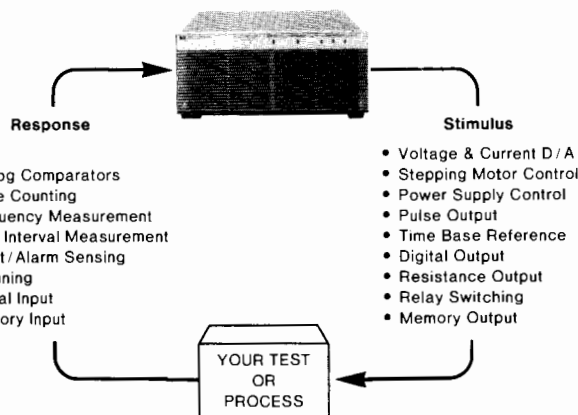

Benefit from the Multiprogrammer Functional Card System

You can quickly design and implement a control system using the HP-IB and one of the HP Multiprogrammers. Choose from the wide selection of functional plug-in cards and assemble them into a Multiprogrammer mainframe to economically interface your analog and digital input/output signals. The Multiprogrammer provides the interface between your HP-IB controller and the physical world. Thousands of Multiprogrammers are in everyday use as the nucleus of user defined and assembled systems for production testing and control, data acquisition, process monitoring, laboratory experiment control, life testing, quality control, and component evaluation.

Start building your system with one of the HP Multiprogrammers combined via the HP-IB with a computing controller. To help you, HP offers a variety of proven design aids. These include the *Multiprogrammer Technical Brochures* complete with capabilities, typical system layouts, specifications, and more; ... *A User's Guide* that gives you sample programs, test routines, and I/O interface data for all 38 Multiprogrammer plug-in cards ... There is also a *Utility Cartridge* with a recorded program ready to use in the HP 9825, 9835 and 9845 computing controllers, to aid in writing your own application ... and a *System Throughput Analysis* that allows you to accurately determine the measurement and control speed you can expect before you build your system.

Refer to pages 55 & 61 for more details on the HP 6940B and 6942A Multiprogrammers and how they are used with the HP-IB.



HEWLETT-PACKARD INTERFACE BUS

Versatile Interconnect System for Instruments and Controllers

Model 37201A



- Transparent extension of HP-IB systems
- Operation over twin-pair cable or modems
- Automatic error detection and correction
- High immunity to electrical interference
- Multi-point (multi-drop) capability
- Auto-dialler interface

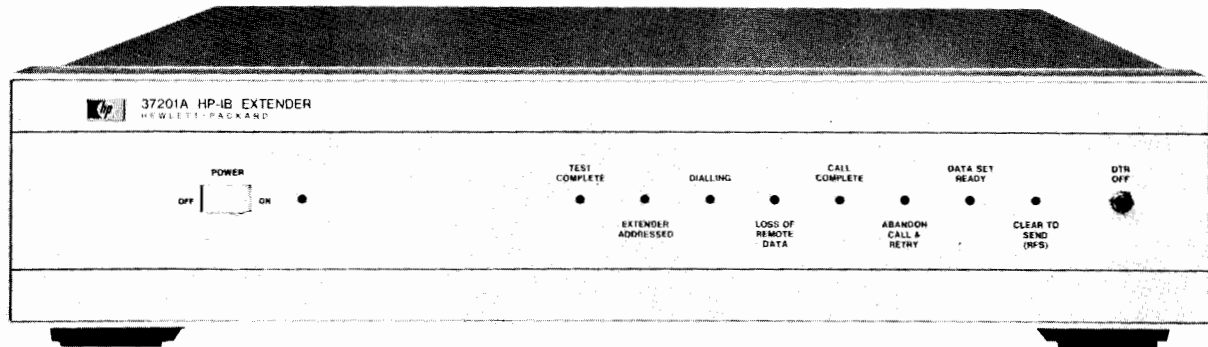

The 37201A HP-IB Extender overcomes the limited range available with direct HP-IB cable interconnections. Each 37201A converts parallel data from the interface bus into a serial bit stream, suitable for transmission to a remote site, and reconverts incoming serial data to bit-parallel HP-IB format. An HP-IB system can therefore be split into two or more discrete parts separated by HP-IB Extenders and a serial data link. A range of 1000 metres is obtainable if twin-pair cable is used for the transmission path, and virtually unlimited range is available if a modem link is used. Communication between Extenders is full duplex, allowing information to flow in both directions simultaneously.

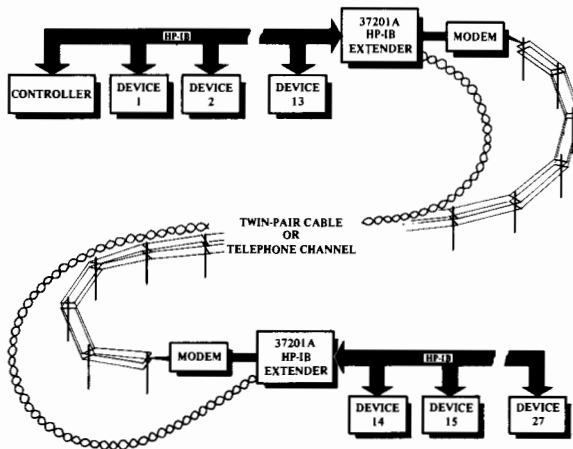

Point-to-point connection using twin twisted pair cable or full duplex modem link.

A pair of HP-IB Extenders provides a transparent interface between local and remote HP-IB devices. Program control of the 37201A is seldom necessary. Consequently, HP-IB Extenders can be added to an HP-IB system usually without any modification of software and without writing special routines to control the Extenders. The 37201A supports the full range of HP-IB functions with the exception of Parallel Poll and Pass Control.

Integrity of HP-IB data and control signals is assured by an automatic error-checking protocol, which retransmits any data corrupted in transmission. The 37201A is in general compliance with each of the following standards and supports their major capabilities:

- IEEE Standard 488-1978
- ANSI Standard MC1.1
- IEC Standard 625-1

Twin-Pair Cable Operation

Twin twisted-pair cable provides a simple inexpensive transmission medium for distances up to 1000 metres. The serial data rate is nominally 20 kbit/s. Suitable cable is available as an accessory (HP Part Number 8120-1187). Transformer coupling within the 37201A gives a high degree of immunity from the effects of common mode signals. This, combined with the automatic error correction capability, makes the 37201A suitable for use in an electrically hostile environment.

Modem Link Operation

The 37201A is designed to operate with a wide range of synchronous and asynchronous modems over private lines, leased lines, or the public switched (dial-up) telephone network. The data interface is compatible with EIA RS-232C and CCITT V.24 and V.28 standards. Asynchronous data rates provided are: 150, 300, 600, and 1200 bit/s. For synchronous modems, operation at any bit rate up to 19.2 kbit/s is possible. Besides operating in point-to-point mode, the 37201A can be used with modems in a multi-point (multi-drop) leased line configuration involving up to 31 remote sites. When operating over the public switched telephone network, connections may be dialled manually. Alternatively, an external auto-dialler may be used to make connections under program control. The 37201A has an RS-366/V.25 interface to permit operation with an auto-dialler.

The error checking/correcting communications protocol used in the 37201A protects against errors introduced by poor quality data circuits. It even provides immunity to major interruptions in the data link, such as dropouts, line breaks and modem sync loss, and recovers automatically without loss of data.

37201A HP-IB Extender

\$2330

HEWLETT-PACKARD INTERFACE BUS

Versatile Interconnect System for Instruments and Controllers

Models 37203A, 37203L

- Transparent HP-IB extension up to 1000 metres
- HP-IB Transfer rate up to 50 k bytes/s
- Supports all HP-IB functions including Pass Control and Parallel Poll

- Electrical isolation plus error detection and correction protect HP-IB from transmission errors
- Transmission over single low-cost coaxial cable or, with Option 001, dual optical fiber

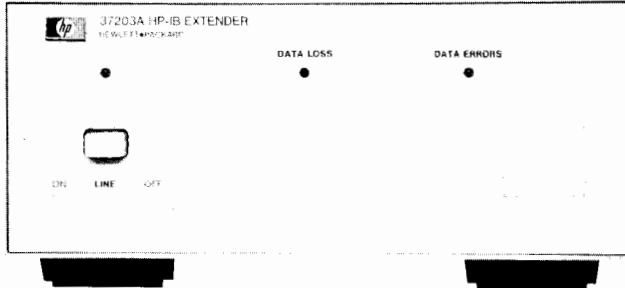

37203A

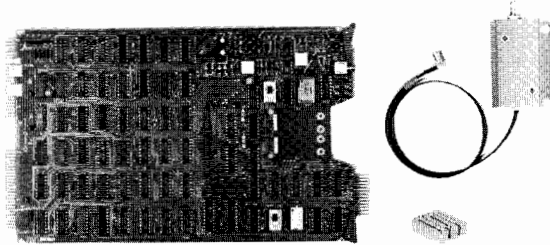

37203L



37203A HP-IB Extender

The 37203A HP-IB Extender overcomes the range limitations imposed by the cabling rules of the Interface Bus and provides high-speed, low-cost extension up to 1000 metres.

37203A's are used in pairs: each Extender serialises the normally parallel HP-IB information and transmits it to the other Extender where it is reconverted back to its original format. The transmission medium can be a single low-cost coaxial cable for both directions of transmission or, when Option 001 is fitted, dual optical fiber.

The 37203A is in general compliance with each of the following standards and supports their major capabilities

- IEEE Standard 488-1978
- ANSI Standard MC1.1
- IEC Standard 625-1

37203L HP-IB Extender

The 37203L is a repackaged version of the 37203A on an L-series computer card specifically designed for installation in the HP 2250A Measurement and Control Processor and HP 1000 L-series Computer. It operates in conjunction with a 37203A or another 37203L at the other end of the link. The transmission media and distances are the same as for the 37203A. The 37203L is supplied as a single circuit card together with two cable assemblies. Power is supplied from the 2250A or Computer mainframe. Operating characteristics are identical to those of the 37203A.

Operating Characteristics (37203A/L)

Speed / Range

The table below shows the trade-off between maximum byte transfer rate and distance for coaxial cable and optical fiber.

Table 1. Nominal HP-IB Transfer Rates and Response Times

	Max HP-IB byte transfer rate (kbytes/sec)	Max SRQ propagation delay (μ s)	Max Parallel Poll response time (μ s)
Coaxial Cable			
Short* (at normal speed)	50	14	20
250m (max range at normal speed)	40	18	25
500m (max range at 1/4 speed)	14.2	55	75
1000m (max range at 1/16 speed)	2.75	200	270
Fiber Optics (opt 001)			
Short*	50	14	20
250m	39	20	25
1000m	25	30	40

*For distances <250m, interpolate between Short and 250m.

Parallel Poll Operation

The 37203A supports the Parallel Poll function but because of the absolute transmission delay, a guaranteed response cannot be delivered within 200 ns, as required by IEEE 488. Instead, the response from distant devices is returned as rapidly as possible to the polling controller.

Error Detection and Correction

Data is transmitted across the link in frames. Each frame includes a cyclic redundancy check code which is rechecked when the frame is received. Any transmission errors which are detected cause the frame to be rejected. Data integrity is maintained by automatic retransmission of the rejected data frame. The presence of errors in the received data causes the DATA ERRORS indicator on the 37203A front panel to be illuminated.

Transmission Over Coaxial Cable

The standard serial link between Extenders is a single coaxial cable which is used for transmission in both directions. Coaxial cable was chosen for this link because it is relatively inexpensive, easy to handle, and easy to obtain. The use of Belden type 9248B cable (or equivalent) is recommended.

Transmission Over Optical Fiber

Option 001 of the 37203A/L provides the capability of operation over duplex optical fiber as a user-selectable alternative to coaxial cable. The use of optical fiber removes the metallic path between the Extenders and, therefore, eliminates all risk of electromagnetic pick-up on the link. Option 001 is recommended for use in severe electrical environments or where the use of electrical signalling is not acceptable. A further advantage of optical fiber is that it enables a higher byte transfer rate to be attained for transmission distances greater than 250m than is possible with coaxial cable (see Table 1).

39200 Series Fiber Optic Cables

Operating temperature: -20 to 70°C.

Storage temperature: -40 to 85°C.

Relative humidity: 95% at 70°C (max).

Max. tensile force on cable: 300N.

Max. tensile force on connector/cable: 100N.

Min. bend radius: 7 mm (0.3 in).

Flexing: 50000 cycles (180° bending at min bend radius).

Crush load: 20 kg (44 lb).

Options (37203A/L)

001: Fiber Optic Interface

301: Rack Mount Adaptor (37203A only)

302: Dual Rack Mount Adaptor (37203 only)

Price

add \$470

add \$30

add \$50

Ordering Information

37203A HP-IB Extender

37203L HP-IB Extender

\$1295

\$1030

HEWLETT-PACKARD INTERFACE BUS

Versatility in Connecting Instruments to Controllers

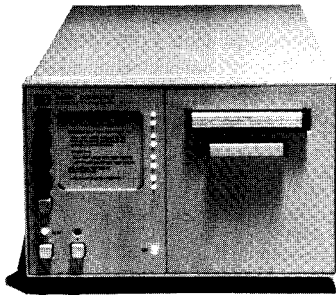

HP 9915A Modular Computer (HP 98264A Interface)



HP 9826 Desktop Computer (HP 98034B Interface)

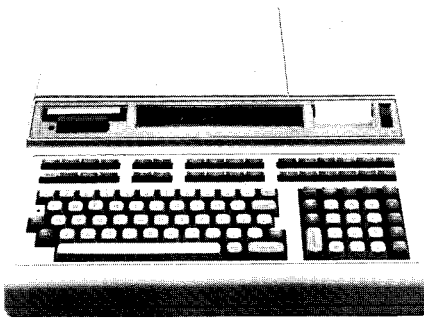

HP 9825 Desktop Computer (HP 98034B Interface)

Role of a Controller

A controller performs a variety of functions, the most obvious being information management over the bus. In measurement systems, the controller schedules tasks, sets up each device to perform the desired task, monitors measurement progress and interprets results.

In addition, HP controllers can provide access to a variety of computer peripherals, i.e., displays, printers, and disc and tape storage units. These controllers also provide such program development tools as editors, debugging aids, and the means for storing and recalling programs and/or results.

Controller and Interface Selection

Hewlett-Packard offers a wide selection of HP-IB (IEEE-488) controllers. Using HP-IB allows any of these computers to control up to 14 HP-IB compatible devices per interface.

For engineering design, testing and other single-user applications, desktop models such as the HP-85, 9915, 9825, 9826, 9835 or 9845 may be preferred. But for testing at multiple locations and for multiple users, the choice might be one of the HP 1000 computer models.

A brief description of these computers is provided here. For detailed information on HP computers, please see pages 658 through 666.

Controllers Working Together

The fact that HP offers controllers of various sizes, costs, features and capabilities to meet specified needs has another advantage. Establishing cooperation between two or more of these computers merges their relative strengths to form a system with more efficiency and versatility. For example, desktops offer excellent local control, friendliness and computational power. Passing programs and data between an HP 1000 and desktops reduces wear on the desktops, provides for central data reduction and storage, and allows for some central control.

HP-85A and 9915 with 82937A HP-IB Interface

The HP-85A is a complete BASIC language computer with up to 32K bytes of read/write memory, up to 80K of read-only memory, a built-in CRT display, and a quiet, built-in, bidirectional thermal printer. Configured with the I/O ROM and the 82937A HP-IB Interface, the HP-85A is an economical HP-IB controller.

The 9915 Modular Computer is the functional equivalent of the HP-85 with peripherals deleted. It is designed for integration into instrument systems, including rack mounting. A simplified operator's panel reduces user errors.

9826 Computer System

The HP 9826 is Hewlett-Packard's newest desktop computer. Its fast I/O and computation speeds make it an ideal controller. An integrated system, it incorporates a new microprocessor, up to 512K bytes of read/write memory, multiple languages (BASIC, HPL and Pascal), 7-inch CRT, typewriter-like keyboard, CRT-labeled softkeys and flexible disc drive. The 9826 has a built-in HP-IB interface, display graphics and a rotary knob for analog program control. A second HP-IB interface, product number 98264A, can be added.

HP 9825, 9835 and 9845 Computer Systems and the 98034B HP-IB Interface

The 9825 uses HPL, a high-level programming language that provides for subroutine nesting and flags. It includes a two-level interrupt capability. The 9825 has a 32-character alphanumeric display, a 16-character printer and a high-performance tape drive. Three slots are available for a range of interfaces.

The 9835A/B offers user read/write memory from 64K to 256K bytes, built-in tape drive, optional thermal printer and a range of interfacing capabilities, plus 15 levels of priority interrupt. The 9835A has a 12-inch CRT display, while the 9835B has a single-line display. The standard programming language is BASIC, with Assembly Language available for specialized applications.

The 9845 computer systems excel in applications demanding advanced graphics and computational capability. They provide 15 levels of priority interrupt, and include a CRT display, an optional thermal line printer, enhanced BASIC language and tape drive. The 9845 offers sophisticated color graphics (optional) to enhance data presentation, and a CRT capable of displaying up to 4913 colors.

These computers require the HP 98034B Interface for HP-IB applications. I/O ROM's are built into the 9825 for HP-IB control, while the 9835A/B requires an optional General I/O ROM; the 9845 has complete HP-IB capability when combined with the Option 312 I/O ROM. Multiple interfaces can be plugged in, and the 9878A I/O expander is available.

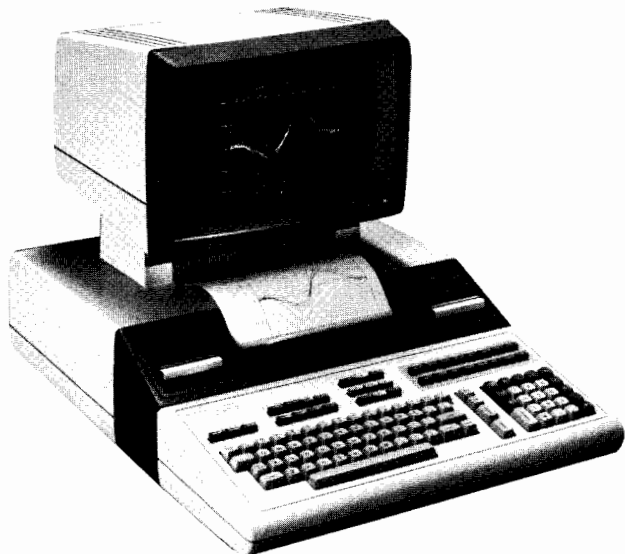

HP 9845 Computer System (HP 98034B Interface)

HP 1000 and 12009A and 59310B HP-IB Interfaces

The HP 1000 computer system is well suited for broad measurement and data management requirements. With Real Time Executive Software, the HP 1000 can concurrently control multiple clusters of HP-IB test and measuring equipment, which may be organized into separate physical or functional groupings. Each grouping may have up to 14 HP-IB devices per cluster.

Each separate bus cluster connected to the HP 1000 requires one 59310B Interface. The 59310B is supported by a driver, utility software and a manual supporting operation in HP's RTE-II and RTE-IV Real Time Executive systems. A diagnostic routine for quickly confirming correct operation is included with the interface. Compatibilities among various HP computer systems, computers and operating systems are shown below. Note that the 59310B interface may also be used with HP 2100A/S computers.

	HP 1000	HP 2105A	HP 2176A/B 2177A/B	HP 2100A/S
RTE-II	yes	no	yes	yes
RTE-IV	yes	no	yes	no

Other Interfaces

HP offers all the above HP-IB interface cards, plus others designed for customers who want to build custom, computer-controlled instrumentation systems.

HP-85 and 9915 Interface Cards

- 82939A Serial Interface — provides RS-232-C compatible I/O for communication with devices such as printers and terminals.
- 82940A GPIO Interface — general purpose 16-bit interface for connection to TTL-type signal levels.
- 82941A BCD Interface — 11 digit input or output capability for binary coded decimal instruments.

9826 Interface Cards

- 98620A two channel interface — two channel DMA for high-speed I/O.
- 98622A 16-bit Interface — latched 16-bit input/output for bidirectional information transfer.
- 98623A BCD Interface — connects with bit-parallel, digit-parallel and binary-coded decimal devices.
- 98626A Serial Interface — provides bit-serial communication to asynchronous EIA RS-232-C (CCITT V.28/V.24) devices.



HP 1000 Computer System (HP 59310B (or 12009A for L Series) Interface)

9825, 9835 and 9845 Interface Cards

- 98032A 16-bit Parallel Interface — latched 16-bit input/output for bidirectional information transfer.
- 98033A BCD Input Interface — connects the 9825 with bit-parallel, digit-parallel BCD devices.
- 98035A Real Time Clock — adds real time reference and time-related control capabilities to the 9825, 9835 and 9845.
- 98036A Serial Interface — provides bit serial communication between the desktop computers and asynchronous EIA RS-232-C devices such as data terminals and modems.
- 98040A Incremental Plotter Interface — allows the 9845 to access large flatbed and drum incremental plotters.
- 98041A Disc Interface — allows the 9845 to access large capacity, high-speed disc peripherals.
- 98046B Intelligent Datacomm Interface — provides bit-serial communication between 9835 or 9845 and asynchronous/synchronous EIA RS-232-C devices. Baud rates programmable to 9600 bps.

Ordering Information

	Price
12009A HP-IB (IEEE-488-1978) Interface for HP 1000 L-series	\$895
59310B Interface, RTE-II/IV for HP 1000	710
82937A HP-IB (IEEE-488-1978) Interface	395
82939A Serial Interface	395
82940A GPIO Interface	495
82941A BCD Interface	495
98032A 16-bit Parallel Interface	525
98033A BCD Input Interface	525
98034B HP-IB (IEEE-488-1978) Interface	600
98035A Real Time Clock Interface	630
98036A Serial Interface	735
98040A Incremental Plotter Interface	630
98041A Disc Interface	3000
98046B Intelligent Datacomm Interface	1000
98620A 2-channel DMA Interface	425
98622A 16-bit Parallel Interface	275
98623A BCD Interface	275
98624A HP-IB (IEEE-488-1978) Interface	325
98626A Serial Interface	275

HEWLETT-PACKARD INTERFACE BUS

Versatile Interconnect System for Instruments, Computers, and Controllers

Model 1351S

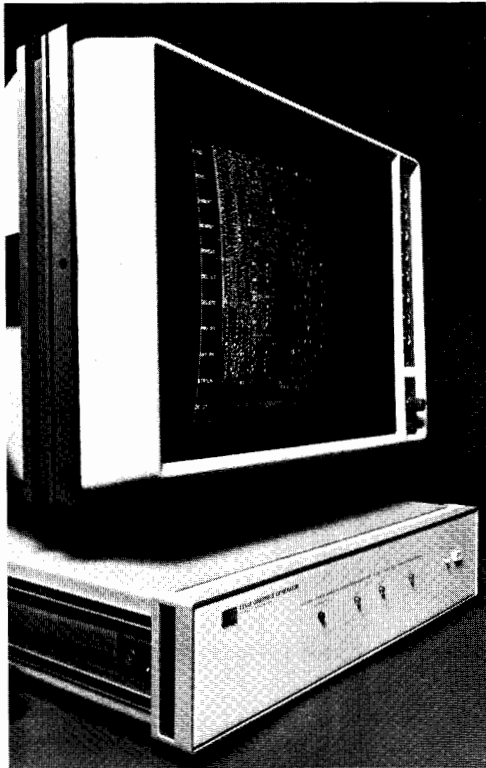

Features

- High resolution, high speed large screen display
- Advanced low power electrostatic deflection
- Optional screen sizes, phosphors
- 8k vector/character generator
- 64 addressable memory files
- Intensity highlighting
- Selective erase/update
- Directed beam vector/character stroking

Description

Model 1351S is a high performance computer graphics display system for generating vectors and alphanumerics on large screen high resolution HP displays. It provides the fast information throughput, rapid picture manipulation, and complex vector drawing capability needed in interactive computer graphics for computer-aided design/computer-aided manufacturing (CAD/CAM) systems, and radar/simulation.

The system consists of a 1351A Graphics Generator, an interconnecting cable, and an HP 1311B 14-inch directed beam electrostatic display with tilt stand. Optional display sizes of 17, 19, and 21 inches are available. A complete highly interactive graphics system can be assembled with the addition of a compatible computer, and HP peripherals such as a tablet and plotter.

Digital information is received by the graphics generator from the standard HP-IB interface or an optional RS-232C or 16-bit parallel interface bus and stored in internal refresh memory. Analog outputs in the form of vectors and characters are then generated and sent to the display where uniformly bright, sharp lines and alphanumerics are produced at high writing speeds. The display is continuously refreshed by the 1351A, freeing the host computer or controller to collect or process other data. The Graphics Generator can address and display 1020 x 1020 points on the CRT display.

High Speed Graphics

The digital memory of the 1351S can be addressed in random fashion. Thus, any number of vectors or characters can be entered without erasing or rewriting all 8192 memory locations. For example, one curve on a graph can be updated while other picture elements remain unchanged. Random-access memory also increases the speed at which the graphics portion of a system can be operated. The 1351S is ideally suited for real time applications.

Versatile Operation

Up to 64 files are available for storing text, graticules, or other segments of the picture. A file can be repetitively flashed to alert an operator to abnormal system operation such as an out-of-tolerance measurement. File Management capability allows the 1351S to display different information on up to three additional CRT's.

Software Graphics Library

A 10184B Software Graphics Library option simplifies programming the 1351S when it is used with the 9825 Desktop Computer. It uses most of the same program commands as the 9872 or 9862 plotters. Additional commands are provided to blank and view individual files as well as flash segments of the picture. The 10184B program resides in 9825B memory, occupying 3806 bytes.

RS-232-C Interface Option

An RS-232-C interface option (001) can be substituted for the standard HP-IB interface. Option 001 is a teletypewriter interface (standard EIA RS-232-C/CCITT-V-24).

Option 001 operates in an asynchronous, receive only mode. It provides a system clock at standard baud rates from 110 to 9600 that can be used to clock the teletypewriter interface in the controller or computer.

16-Bit Parallel Interface Option

A 16-bit parallel binary interface option (002) is also available in lieu of the standard HP-IB interface. This option allows the 1351A to receive data from a 16-bit computer or controller configured to output 16-bit bytes at very high data rate. The data transfer rate is 500k 16-bit bytes/sec, or up to approximately 250k vectors/sec.

NOTES

For complete description and specifications, request technical data sheets for the 1351S Display System, the 1311B Display, and the 1351A Graphics Translator. An HP-IB cable is not supplied with the 1351S, and must be ordered separately.

Options

Options	Price
001: RS-232-C interface with selectable baud rates, replaces HP-IB interface	Add \$300
002: 16-Bit parallel interface replaces HP-IB interface	N/C
010: Short tilt stand for 1311B only, replaces tall tilt stand	N/C
011: Short tilt stand for 1310B only, replaces tall tilt stand	N/C
024: Model 52124A 10-metre interconnecting cable replaces Model 52125A 1-metre cable	Add \$75
184: Model 10184B Software Graphics Library (1351A/9825)	Add \$150
510: Model 1310B 19 in. display replaces 1311B	Add \$600
517: Model 1317A 17 in. display replaces 1311B	Less \$400
521: Model 1321B 21 in. display replaces 1311B	Less \$200
604: P-4 phosphor replaces P-31	Add \$30
639: P-39 phosphor replaces P-31	Add \$30
908: Rack mounting parts for 1311B and 1351A, deletes tilt stand from 1311B	Less \$230
909: Rack mounting parts for 1310B and 1351A, deletes tilt stand from 1310B	Less \$230

*Includes Display Option 057 (Z-axis control of brightness)

Ordering Information

Model 1351S Display System

Price

\$10,850

HEWLETT-PACKARD INTERFACE BUS

Fully Programmable Digitizing Oscilloscope

Model 1980/19860A

37



Hewlett-Packard's measurement and computation technologies are combined in a powerful, programmable Oscilloscope Measurement System, the 1980. Its capabilities include full programmability of front panel setup, including variable functions (e.g., deflection factors, sweep speeds, etc.) and the ability to send these settings back to a computer. With the 19860A Digital Waveform Storage option added, complete waveform data can be digitized and sent or received over the HP-IB interface.

The 1980/19860A combination greatly reduces measurement time while improving accuracy and repeatability by eliminating operator involvement with completely automatic operation. Repetitive events to 100 MHz or single-shot events to 5 kHz (10 points per period) can be captured, displayed, and sent to a computer via HP-IB for analysis. This programmable measurement capability offers fully automatic data acquisition for fast, reliable solutions to complex or time-consuming measurements while dramatically improving productivity.

All of the Model 19860A's capabilities can be automatically controlled through the HP-IB interface by an external computer, adding a new dimension to time domain measurements. The 19860A uses the 1980A/B's HP-IB port so there is only one HP-IB address for the system. Program codes are simple three-letter mnemonics with one or two integers to define program code parameters. Each 19860A mnemonic has the letters "DG" for the digitizer to simplify identification of 19860A commands from 1980A/B commands. For example, "DGS1" stores a signal in memory one.

Model 19860A provides the choice of ASCII or Binary format for transferring waveform data over HP-IB. This allows data transfer and computation time to be optimized for different controllers. ASCII transfer requires six bytes per point (four digits for the point and CR LF) where Binary transfer only requires two bytes per point.

Automatic Test Systems

The 1980/19860A system can greatly improve the efficiency of test systems by completely automating time domain measurements. This fully programmable system can be automatically set up to acquire a signal, digitize it, and transfer it to a computer to provide complete answers without operator intervention. A series of standard signals may be digitized and stored in a computer to build a library of references for automatic testing.

Semiautomatic Testing

In applications where operator interaction is required, such as circuit setup, calibration, or troubleshooting, the programmable system capabilities improve productivity by eliminating operator setup time. A controller can set up the front panel and write a reference waveform with text on the CRT to direct an operator through a calibration sequence. The operator only has to make circuit adjustments so that a real time trace is positioned between two reference waveforms.

Furthermore, the 1980 front panel controls can be redefined in a programmable station. For example, the rotary control could be re-

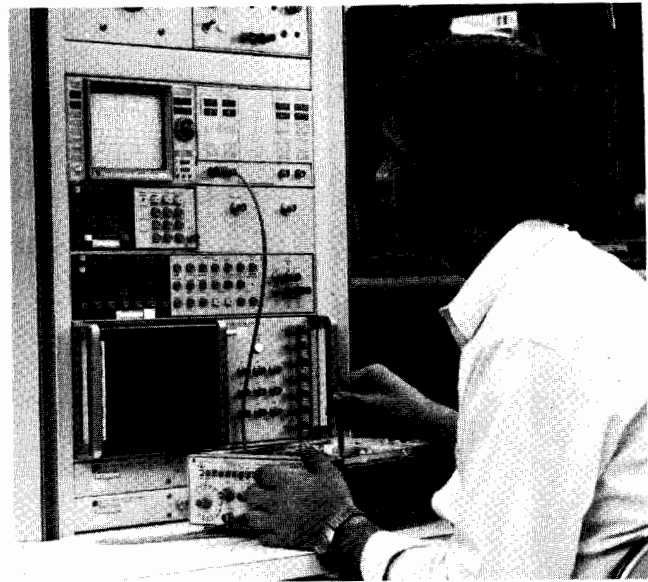

defined to control the adjustment of another instrument as directed by instructions on the CRT. In a similar fashion, the soft keys can be redefined with the appropriate instruction to control the modes of other instruments.

Bench Operation

In bench applications with a controller, engineers can quickly develop and maintain a data base to log the results of design changes. Combined with other programmable instruments, long tests can be automatically accomplished over night or weekends to provide circuit characterization. With a plotter, graphs of waveforms can be easily maintained to record any changes in circuit response with design changes. Also, with the appropriate controller software, answers to frequent measurements can be obtained with the press of one of the 1980 soft keys.

Without a controller, the 1980/19860A can be used as a traditional oscilloscope with the added benefits of the easy-to-use front panel and software features. The Auto-Scope capability automatically scales a signal with the press of one key which reduces the time for initial instrument setup. Frequently used front panel setups can be saved in eight local registers and quickly recalled to reduce measurement time.

For ordering information refer to 1980A/B page 203.

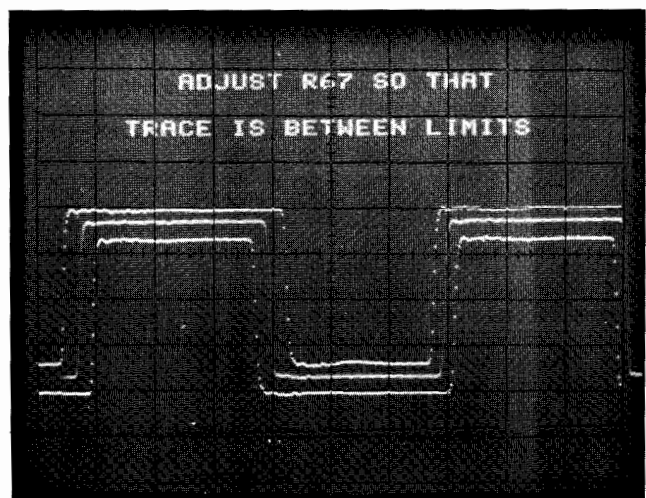
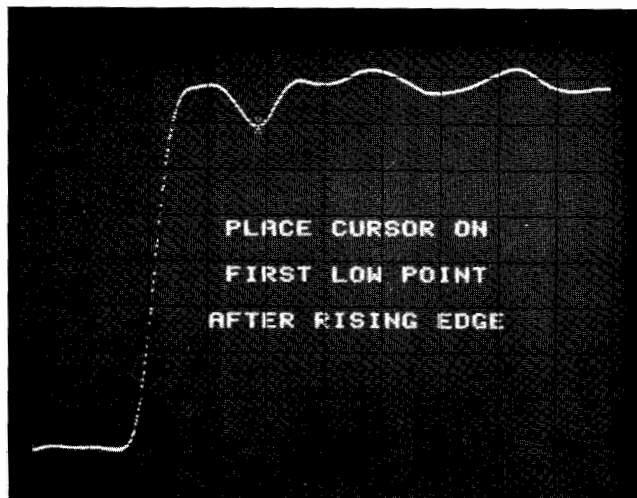

In semiautomatic applications, text and waveforms written on the CRT by a computer guide operators through measurements or adjustments.



2250A

Hewlett-Packard's automatic data acquisition and control equipment serves an ever-growing role as the world's industry strives to increase its productivity. More and more industries are discovering that automation is the key to remaining competitive and profitable. This section will outline some of the points that should be considered when evaluating automation solutions.

Industrial automation applications can be organized into three ideal types. Each type has a different focus and characteristics. The three types are **Test**, **Measurement**, and **Control**.

Test

The approach to industrial automation described as **Test** represents a situation where a product or device is being checked to its design standards. The variables to be measured and the requirements for accuracy and precision are well known. As an example of the **Test** philosophy, consider battery testing. A definite set of variables are measured (output voltage, voltage under load, output current charge capacity, etc.). Expected values and allowable tolerances for all inputs are known in a test application.

Measurement

A measurement approach to industrial automation includes applications that evaluate or research a device, design or phenomenon. Unlike the **Test** approach, the measurement model is not known, in fact the quantities may not be understood. **Measurement** is the gathering of the data to construct a model of the unknown. As an example, scientists are researching ways to maximize food production by optimizing plant watering methods. These scientists might adopt a **Measurement** philosophy by attempting to characterize the response of crops to various watering strategies. Quantities they might need to measure include plant weight, growth, leaf temperature, etc. It is very likely that as they develop a model of how a plant reacts to different watering strategies they will want to measure other things, i.e., they will seek to improve their model.

Control

A **Control** type of application is similar to a **Test** application in that the model or process is well understood. A **Control** system would

make a series of events take place and make measurements that are necessary to insure that the events take place and to guide further events. As an example, consider the sequence of events in a metal casting and curing operation. Because the parts may be used in aircraft, careful control and documentation of the process will be needed. For example, the controls on the curing oven will be set according to the particular part being produced. In addition, to comply with the documentation requirements the temperature of the curing oven and the part itself may be needed. To insure against costly rework or scrap, the control operation needs to sense other critical events and to take appropriate action.

The three classes of industrial automation described above are ideal and any real world application would probably be a composite of all three. However, the three ideal classes emphasize certain requirements and will help in recognizing what set of equipment is best suited to fit a specific automation application. The following sections will analyze test, measurement and control applications in regard to instrument and computer features.

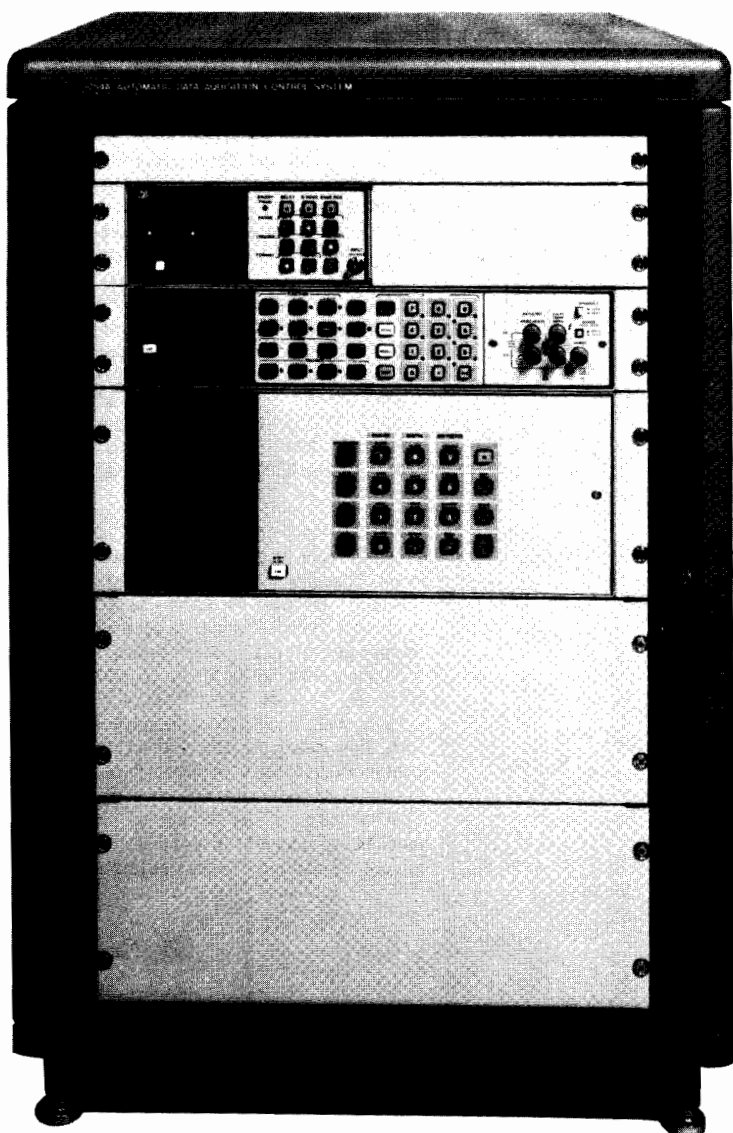

3054A

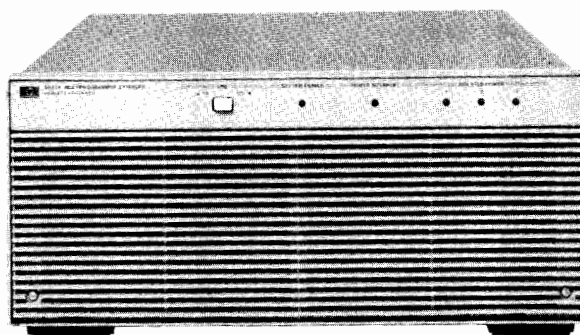

6942A

Measurement Speed

Maximizing measurement speed is often a characteristic of test and control applications where throughput and production efficiency are of great concern. As a general rule there is a trade-off between speed and accuracy—the longer something is measured, the more accurately it is measured. Or conversely, the faster an input is measured, the less accurate the measurement.

Comparison of Analog Measurement Speed

	Resolution	Maximum Readings/ Second
3497A	1 part in 120,000	50
	1 part in 12,000	200
	1 part in 1,200	300
3054A/C	1 part in 1,200,000	48
	1 part in 120,000	210
	1 part in 12,000	330
	1 part in 1,200	5,000
6940B	12 bit	7 (integrating converter)
	12 bit	20,000
6942A	12 bit	33,000
2240A	12 bit	20,000
2250A	14 bit	50,000
1000L	12 bit	55,000
M/C Cards		

Accuracy

High accuracy, wide dynamic range and good resolution are the requirements for measurement applications. In these situations the input signal is frequently small and high accuracy is needed to aid in developing the most accurate model possible. In contrast, in control and production test applications the input is well characterized and therefore the demands of accuracy and resolution may not be as stringent.

Comparison of Analog Measurement Performance

	Sensitivity	Resolution	Accuracy
3497A	1 μ V	1 part in 120,000	.007%
3054A/C	100 nV	1 part in 1,200,000	.0032%
6940B	10 μ V	12 bit	.20%
	50 μ V	12 bit	.15%
6942A	50 μ V	12 bit	.2%
2240A	10 μ V	12 bit	.5%
2250A	1.56 μ V	14 bit	.05%
1000L	625 μ V	12 bit	.1%
M/C Cards			

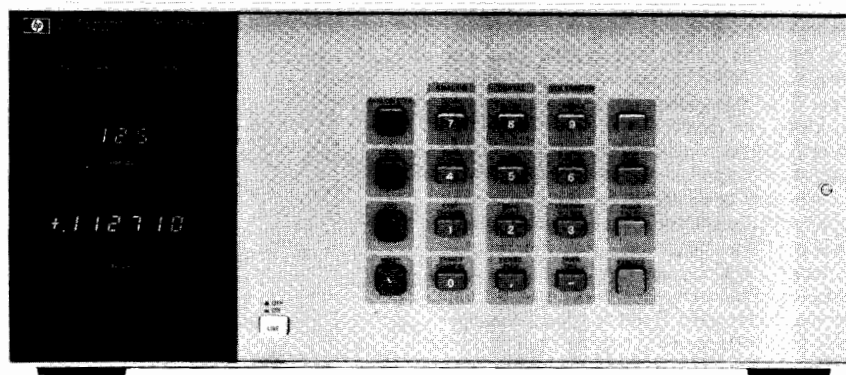

3497A

DATA ACQUISITION, TEST & CONTROL SYSTEMS

Reconfiguration

Measurement applications often require frequent reconfiguration of the measurement system. Test and control applications may remain in the same configuration for years (after initial set up) and therefore, do not need to be designed for frequent reconfiguration. Instruments designed with front panel displays and controls will in general be easier to reconfigure.

Products Having Front Panel Control & Display

3497A	Yes
3054A/C	Yes
6940B	Limited
6942A	No
2240A	No
2250A	No

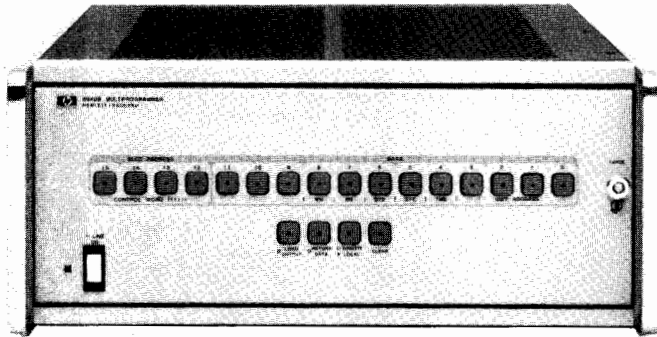

6940B

Control Features

All the Hewlett-Packard products considered in this section have capability to sense digital inputs, count pulse trains, close relays and provide programmable voltage and current outputs. Consider each product in regard to your particular application.

Instrument	Digital Input/Interrupt	Actuator Output	Programmable Voltage & Current	Counter Input	Timer	Pulse Train Output
3497A	X	X	X	X	X	—
3054A/C	X	X	X	X	X	—
6940B	X	X	X	X	X	X
6942A	X	X	X	X	X	X
2240A	X	X	X	X	X	X
2250A	X	X	X	X	X	X
1000L	X	X	—	—	—	—
M/C Cards						

Instrument Intelligence

Applications differ in how much they will require instruments to do independently of a computer.

Measurement applications are usually closely coupled to the computer and place few demands on the instrument. Test and control applications may have higher instrument intelligence requirements. In Test applications the instrument may operate stand alone from the computer and only report exceptions to the test limits. In Control applications it may be desirable for the instrument to operate separately from the computer to protect against computer or I/O link failure. Some products rely on more powerful microprocessors that can operate independently of the main computer. Other products, specifically the 6940 and 6942, rely on card to card cabling to provide additional capability.

Relative Rating of Standalone Product Intelligence (doesn't include computer)

	Relative Rating of Standalone Product Intelligence (doesn't include computer)	Reading Storage	Program Storage
3497A	Low	Yes	No
3054A/C	Low	Yes	No
6940B	Low	No	No
6942A	Moderate	Yes	Yes
2240A	Moderate	Yes	Yes
2250A	High	Yes	Yes
1000L M/C Cards	N.A.	N.A.	N.A.

Environment

Consideration of the operating environment is a very important step in choosing a measurement, test or control system. Any application can require that a test, measure or control system operate in hot, dusty and corrosive environments. In addition, the electrical environment should also be considered in regard to the amount of electrical noise (both common and normal mode) present in the area.

While all Hewlett-Packard instruments are designed to operate in moderately harsh environments, the 2250A Measurement and Control Processor has been specially designed to tolerate more harsh industrial conditions. This includes elevated temperatures and high common mode voltages. Refer to the 2250A literature for additional information.

Integrated Systems

In addition to providing the individual instruments and computers needed for automation, Hewlett-Packard also provides dedicated SYSTEMS that combine instruments, computers, and software with rack mounting and integration. Systems range from the 3054DL Data Logger which provides an easy to use software package for the first time user to the 3054A/C systems which provide utility subprograms that the customer can use to build his own program. Systems have the advantage of providing a more complete solution and allowing the user to concentrate more on his automation task.

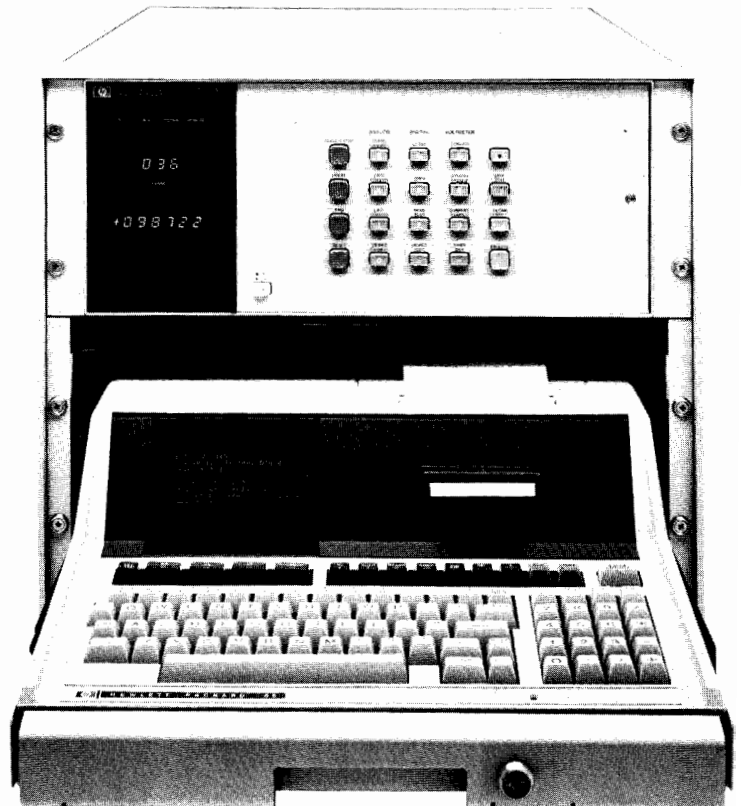

3054DL



Base Instrument	System
3497A	3054DL Data Logger
3497A/3456A/	3054C Automatic Data
3437A	Acquisition/Control System
3497A/3456A	3054A Automatic Data
	Acquisition/Control System
6940B	Software Available
6942A	Software Available
2240A	9030 System
2250A	Software and Integration Available

Customized system integration is also available using the ATS/1000 system integration service. This service combines customer specified measurement and control equipment with HP 1000 computers. Integration ranges from simple racking and cabling to installation of the system and writing of software. (See page 663.)

For further information on these products, please refer to the following catalog pages. Separate technical brochures are also available on each product.

Automation Hardware	Catalog Page	Technical Brochure #
3497A	48	5952-8830
3054A	42	5952-8835
3054C	45	5952-8865
3054DL	46	5952-8848
6940B	55	5952-4025
6942A	58	5952-4034
2240A	64	5953-4230
2250A	62	5953-4288
1000 L	663	5953-4260
M/C Cards		

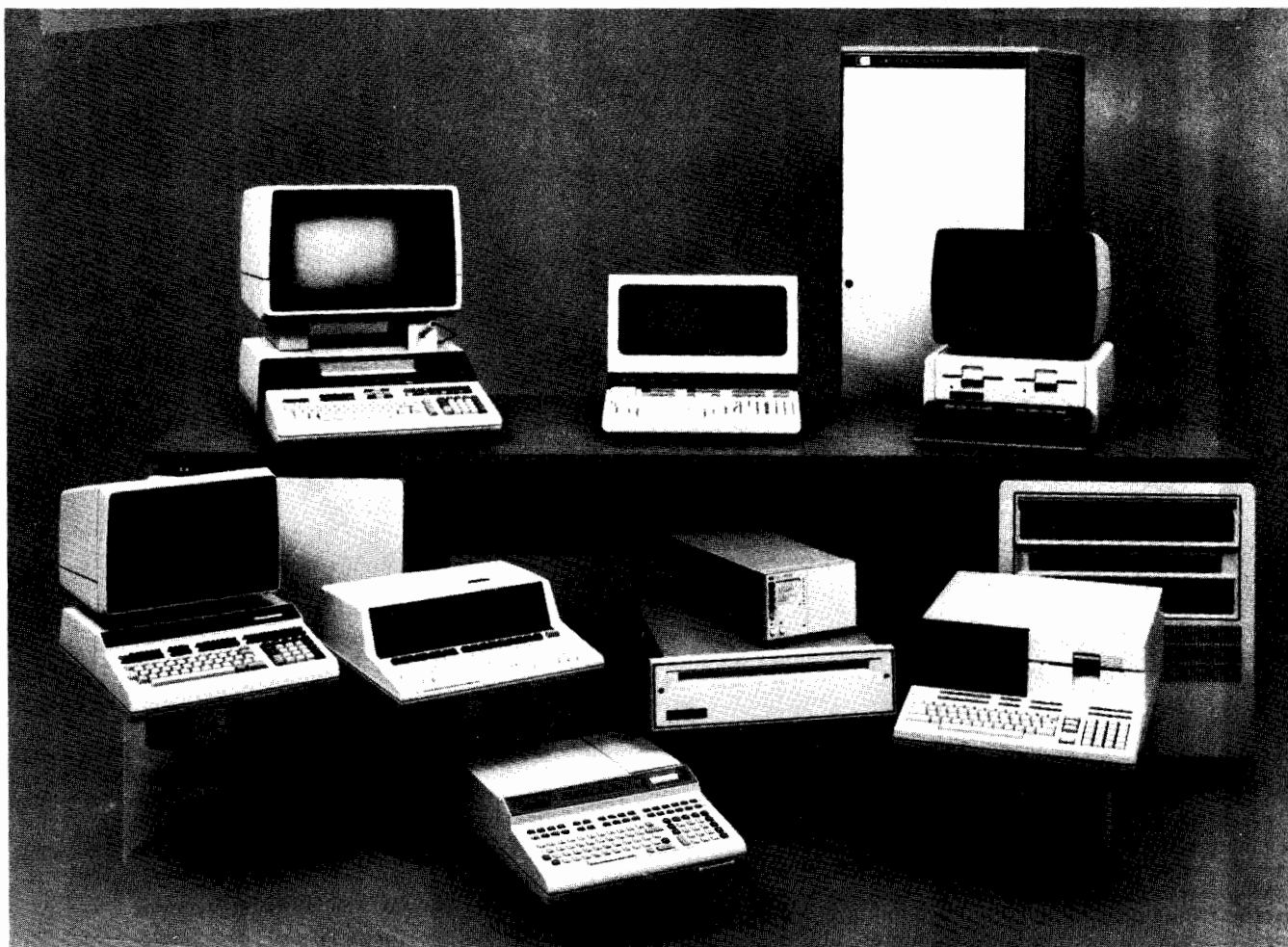

Choosing the Right Computer

A central feature of an automation application is a computer. Hewlett-Packard offers a wide range of computers that can be used to control your automation equipment. In reference to the three ideal types of automation application, measurement applications often require significant evaluation of the data and frequent program changes. For these situations an HP desktop computer that offers a CRT (perhaps with graphics capability), printer, keyboard and mass storage is a good solution in a single package. Some test and control applications do not require an operator interface nearby and may require additional capabilities like distributed operation and simultaneous execution of several pro-

grams. One of the HP 1000 series of computers is more suited for these applications.

In general, you should consider an HP 85, 9825, 9826, 9835 or 9845 desktop computer if any of the following points are key to your application:

- Easiest program development
- Single station application
- First-time computer user
- Remote instrument controller reporting to a central computer
- Portability

In general you should consider an HP 1000 series computer if any of the following points are key to your application:

- Simultaneous execution of multiple

- Multiple terminals and users
- Multiple computer languages on the same computer

For further information on these products, please refer to the following catalog pages. Separate technical brochures are also available.

Instrument	Catalog Page	Data Sheet #
HP 85	654	5953-1939
9825	662	5953-4517
9826	658	5953-4576
9835	660	5953-1099
9845	661	5953-4501
HP 1000	663	5953-4200
HP 1000L	663	5953-4228

DATA ACQUISITION, TEST & CONTROL SYSTEMS

Automatic Data Acquisition/Control System
Model 3054A

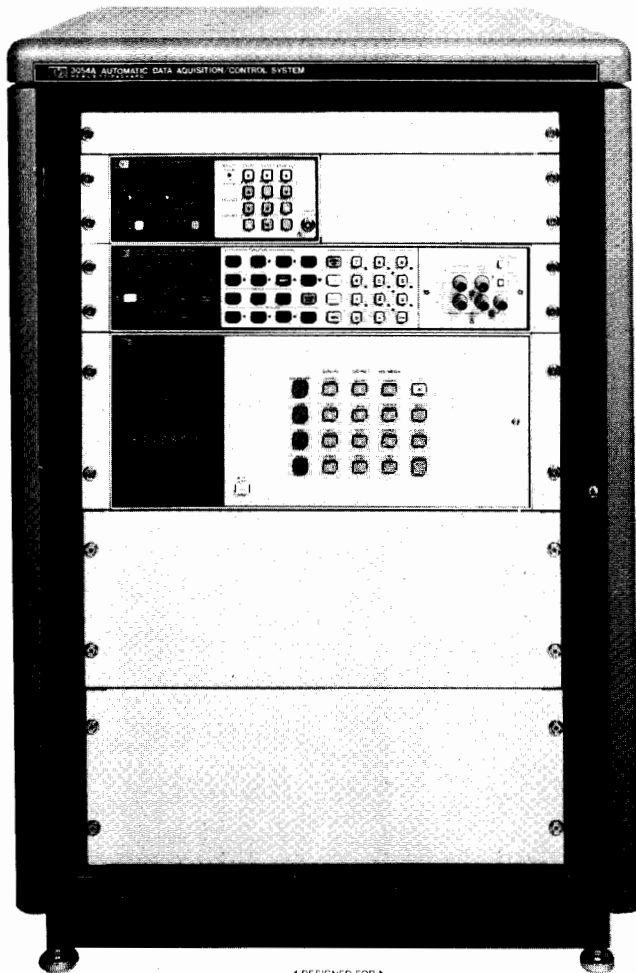

Description

The 3054A is a computer-based automatic data acquisition and control system. The 3054A combines speed, precision and a variety of control functions with full computation and analysis capabilities. The 3054A offers flexibility, convenience, and performance to solve many data acquisition applications.

The system has the flexibility to make a wide variety of measurements, including outputs of thermocouples, strain gages, RTD's, flow meters, and other transducers. The 3054A also has digital inputs and outputs, voltage and current D/A converters for precision closed-loop control.

The 3054A offers the convenience of using instrumentation that is designed as a system. To help the user get started fast, the measuring system is rack-mounted and pre-tested. System specifications represent the summation of all instrument errors. An Introductory User's Guide is part of the system documentation package which enables the user to quickly learn how to use the system for his or her application.

The 3054A system performs by combining speed, accuracy and computational power. Measurement rates from 4500 readings/second to 48 readings/second are possible with resolutions from 3½ digits to 6½ digits. DC measurements of low level transducers can be made with 100 nanovolt resolution with greater than 150 dB of noise rejection. An HP desktop computer or mini-computer will automate the system, store data, linearize transducers, and provide computation and analysis.

- Improve productivity in research and manufacturing
- Low cost data acquisition
- Precision transducer measurements and analysis
- 1000 analog channels and 1360 digital points
- Control functions for closed-loop applications

The 3054A system provides a very powerful, yet economical solution for transducer measurements and production control development.

System Configuration

The 3054A System includes:

3497A Data Acquisition/Control Unit with a front panel display and keyboard, real time clock and HP-IB programming. Optional assemblies and 3498A Extenders may be added as needed to solve your application.

3456A Digital Voltmeter with DC volts, True RMS AC volts, ohms, and ratio measurement capability with HP-IB programming.

3437A System Voltmeter with HP-IB programming

30" Cabinet with filler panels, fan and power outlets

System Documentation and Software includes Introductory Guide, System Operating and Programming Manual, pre-recorded system programming routines, operational verification programs for instruments, application programs and service manuals.

One of four computer configurations is needed to complete the system. You should choose one of the following configurations depending upon the specific requirements of your application.

- (1) **85F Computer**
82903A Memory Expansion Module
- (2) **9826A Computer**
Opt. 001 BASIC
Opt. 004 HPL
- (3) **9835A Computer**
98034B HP-IB Interface
98332A I/O ROM
- (4) **9845T Computer**
98034B HP-IB Interface
98412A I/O ROM



85F
Desktop Computer



9826A
Desktop Computer



9835A
Desktop Computer



9845T
Desktop Computer

Measurement and Control

The 3497A Data Acquisition/Control Unit is the instrument that provides the analog multiplexing, digital monitoring, and control functions using plug-in assemblies. The 20 Channel Reed Relay Assembly provides low level guarded switching with $<2 \mu\text{V}$ of thermal offset. An isothermal connector is provided as an option to this assembly for thermocouple compensation. Digital input and output assemblies are available for monitoring and control. And you get specialized measurement and control using the Reciprocal Counter Assembly and the programmable D/A Converter Assemblies. Up to five of these optional plug-in assemblies can be contained in the 3497A mainframe. Expansion to more than five assemblies is provided by the 3498A Extender. Each 3498A can hold ten more assemblies. A total of thirteen extenders can be supported by one 3497A mainframe, giving a maximum of 1000 analog channels and 1360 digital channels.

System timing is accomplished through the non-volatile real time clock in the 3497A. Besides providing calendar and time of day information, this quartz-based clock has interrupt capability and elapsed time.

The two digital voltmeters in the 3054A System provide a very flexible measurement solution for various data acquisition applications, but the optional DVM assembly for the 3497A is an alternate choice. This plug-in DVM has $1 \mu\text{V}$ sensitivity, $5\frac{1}{2}$ digit resolution, integration, and guarding—capability previously available only on stand-alone system DVMs. (Refer to page 48.)

The 3456A Digital Voltmeter is a $3\frac{1}{2}$ to $6\frac{1}{2}$ digit integrating voltmeter with high accuracy, 100 nanovolt sensitivity, and speed to 330 readings/second. Its DC and True RMS AC voltage and resistance measurement capability reduce the amount of signal conditioning necessary. The 3456A can detect 100 nanovolt changes in 100 mV signals at speeds of 48 readings/second. This capability is necessary for measuring thermocouples with the 3054A system to better than 0.01°C resolution.

The 3456A has selectable integration times from 0.01 up to 100 power line cycles. At 0.01 power line cycles of integration, the reading rate of the 3456A is 330 readings/second with $4\frac{1}{2}$ digits of resolution. With 100 power line cycles of integration plus guarding, the 3456A has greater than 140 dB of effective common mode rejection. The excellent noise rejection and stability make the 3054A system particularly suited for repeatable low level measurements in the presence of noise.

The analog input filter and digital averaging are two more ways the 3456A can eliminate the effects of noise.

The built-in memory of the 3456A can store both readings and sequences of measurement commands. The 3456A can store internally up to 350 readings or up to 1400 ASCII programming characters or combinations of both readings and programming characters.

A scanner advance signal and a voltmeter reading complete signal provide the necessary synchronization between the 3456A and 3497A to achieve analog scanning rates to 300 channels/second. (Refer to page 100.)

The 3437A System Voltmeter is a high speed $3\frac{1}{2}$ digit DC voltmeter which provides precisely timed sample and hold readings. It can perform a variety of tasks from scanning DC inputs to AC waveform analysis. The high speed scanning is provided by a hardware synchronization between the 3437A and 3497A. Repetitive signals with frequency components up to 1 MHz and low frequency transients longer than 1 ms can be rapidly digitized and analyzed. Parameters like RMS value, residual DC, harmonic content, and peak values can be automatically determined in only a fraction of the time required by conventional methods. (Refer to page 98.)

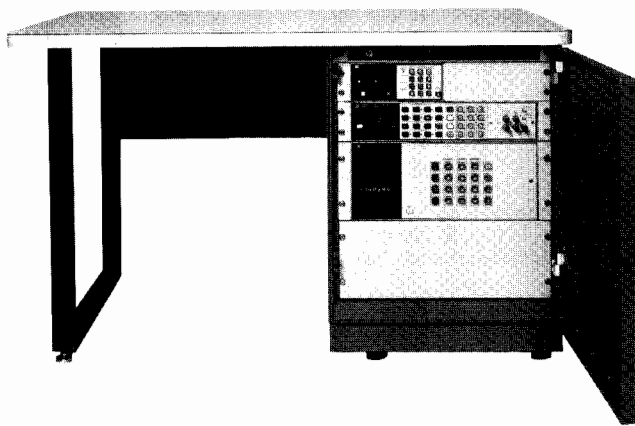

The variety of cabinet options with the 3054A can be configured to fit a wide range of applications.

Power and Performance in Desktop Computers

The choice of four computers with the 3054A provides a wide range of capability and performance for automating data acquisition applications. The desktop computers supported with the 3054A are the HP 85F, 9826A, 9835A and 9845T. The computers automate the system by controlling the instruments and gathering the data over HP-IB. All four computers offer easy interaction to greatly simplify the writing and editing of programs. The friendly languages of the computers and the 3054A software package make it easy to get started. The presentation of data is very versatile when using a computer and external peripherals. Transducer data can be converted to engineering units, statistical analyses of the data can be performed and graphical representations of the data can be produced. The individual capabilities of each computer such as speed, memory size, and output devices should be considered for the different data acquisition applications.

Software and Documentation

The system software is an integral part of the 3054A Automatic Data Acquisition/Control System. Specially written software and documentation packages are supplied for each of the four computers. This complete software package greatly simplifies programming and enables the user to get started fast.

The complete software and documentation package supplied with the 3054A includes:

- operational verification programs
- system sub-programming routines
- typical application programs

The system verification/diagnostic programs can be used to verify that the system is in operating condition at the time of installation. The programming of the 3054A is most effectively accomplished by combining the system sub-program with other system operations. Sample application programs are also provided for assistance in developing functional software.

Racks and Cabinets

Other cabinets may be chosen besides the standard 30" rack for the 3054A. A 16" case is offered as a compact and portable package for the 3054A. A desk provides rack space for the instrument and a table top for software development. The 56" cabinet provides space for additional equipment and future expansion.

For more information on the 3054A, contact the local HP Field Engineer or nearest HP Sales Office.

System Options

Input Assemblies for the 3497A

	Price
010: 20 Channel, Low Thermal Relay Multiplexer Assembly	\$575
020: Relay Multiplexer Assembly with Thermocouple Compensation	\$700
050: 16 Channel, Isolated, Digital Input/Interrupt Assembly	\$525
060: Reciprocal Counter Assembly	\$500
070: 10 Channel, 120Ω Strain Gage/Bridge Assembly	\$800
071: 10 Channel, 350Ω Strain Gage/Bridge Assembly	\$800

Output Assemblies for the 3497A

110: 16 Channel Actuator/Digital Output Assembly	\$650
115: 8 Channel High Voltage Actuator	\$475
120: ±10V Dual D/A Converter Assembly	\$950
130: 0 to 20 mA or 4 to 20 mA Dual D/A Converter Assembly	\$900
230: U.S. Clock Format for the 3497A (Month:Day:Hours:Min:Sec)	N/C
231: European Clock Format for the 3497A (Day:Month:Hours:Min:Sec)	N/C
260: Delete Keyboard and Display on 3497A	less \$350
261: Delete 3437A SVM and HP-IB cable	less \$2,820
262: Delete 3456A DVM and HP-IB cable	less \$3,770
280: Add 5½ digit DVM and current source for the 3497A. NOTE: Only one DVM may be deleted from system, unless optional 3497A DVM assembly is added.	\$1,575
298: Add 3498A Extender and connecting cables	\$1,800

Cabinet Options

400: Delete 30" cabinet; rack-mounting hardware supplied	less \$1,500
416: Add 16" combining case with power strip; delete 30" cabinet	less \$1,000
456: Add 56" cabinet with fan and power strip; delete 30" cabinet	\$200
490: Add 44530A systems desk with fan, power strip, and 23" rack space; delete 30" cabinet	\$800
496: Add locking drawer, 8" high, for 85A	\$350
498: Add locking drawer, 18" high, for 9835A	\$400

Software and Documentation Options

841: Complete 3054A System Documentation—85A	N/C
842: Complete 3054A System Documentation—9825B	N/C
843: Complete 3054A System Documentation—9835A	N/C
844: Complete 3054A System Documentation—9845T	N/C
*801: Complete 3054A System Documentation—9826A (BASIC)	N/C
*804: Complete 3054A System Documentation—9826A (HPL)	N/C

Basic 3054A System

\$11,680

*Available 1st Qtr. 1982



- Precise measurement and analysis
- Execute multiple programs simultaneously
- Communicate to other computers in a distributed network

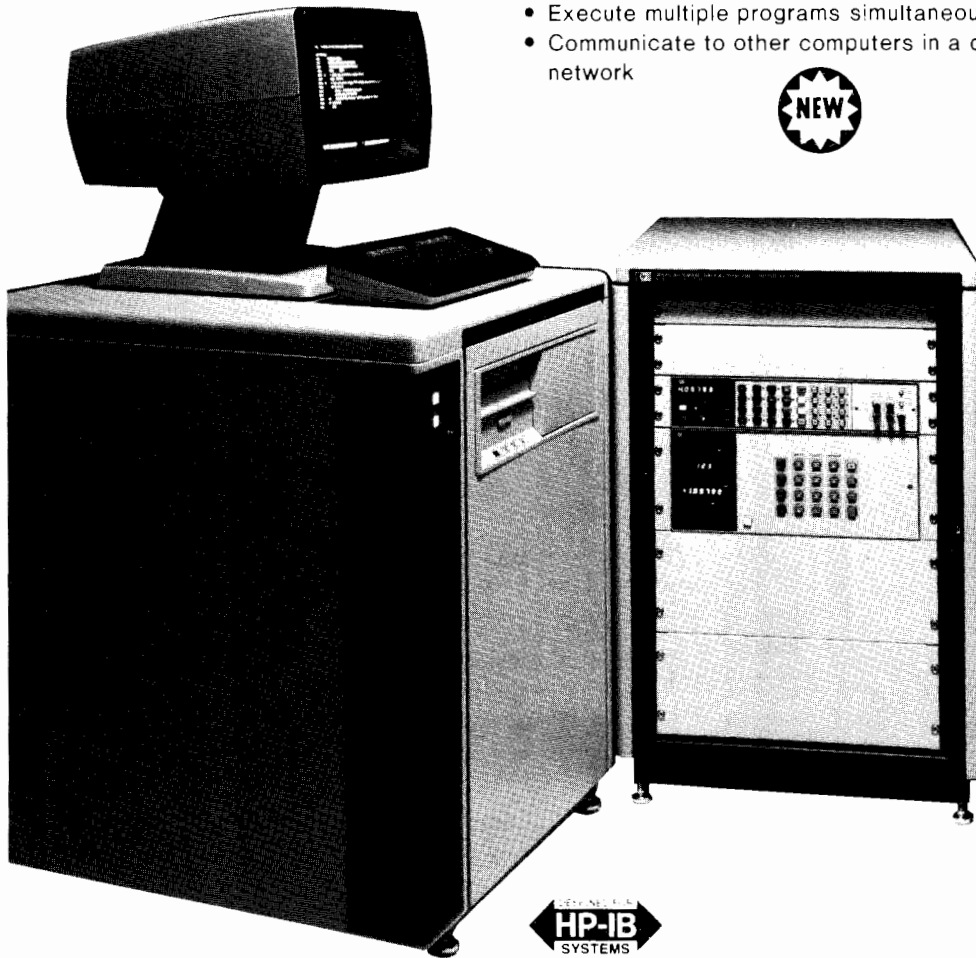

Description

The 3054C Automatic Data Acquisition/Control System combines precise instrumentation with the power and versatility of HP 1000 computers. The 3054C is similar to the 3054A system except that the 3054C supports software compatible with the HP 1000 series of computers. The 1000 series of computers give you increased analysis capabilities and can be used to create multitasking, distributed, data acquisition and control networks. Distributed systems allow you to control instruments with one computer while another computer in the network analyzes or processes the data. The multitasking capability of the HP 1000 allows any computer in the network to simultaneously control instruments with one program while another program performs other, possibly unrelated, tasks.

Instrumentation

The 3054C consists of a 3497A Data Acquisition/Control Unit and a 3456A Digital Voltmeter. The 3497A is a card cage instrument that can be custom configured to meet your needs. Assemblies are available for A/D conversion, multiplexing, strain gage/bridge completion, digital inputs/interrupts, counting, actuator outputs, and voltage and current D/A outputs. The 3456A is a very precise voltmeter and has the resolution and noise rejection required for measuring low levels in a noisy system environment.

Computers

The 3054C software package is compatible with the HP 1000 L, M, E, and F series of computers. These computers allow you to configure or expand your system as needed. The HP 1000 L series computers are well suited to control the 3054C due to their moderate cost and their intelligent high speed I/O. The HP 1000 M/E/F series are good choices where additional computing power is required and are good choices as host computers in a distributed system.

Software

The 3054C software package consists of over 35 subroutines that can be used as building blocks to create a useful measurement program. The subroutines allow the user to write sophisticated programs without knowing instrument programming codes. Included in the 3054C software package are linearization programs for most thermocouples, 120 and 350 Ohm strain gages, thermistors and RTD's. The routines include error trapping to locate and identify system problems.

System Configuration

The 3054C consists of the following. The computer, other computer peripherals and computer operating systems are ordered separately.

3054C

Instruments:

- 3497A Data Acquisition/Control Unit
- 3456A Digital Voltmeter

Software and Documentation

3054C Software package consisting of measurement, conversion, utility and HELP routines.

Rack/Integration

30" Rack (shown) is standard. Other racks are available. Integration includes HP-IB cables, instrument connecting cables and test assemblies.

Verification/Installation

The 3054C is installed and tested with the HP 1000 computer at the customer's site.

Ordering Information

**Basic 3054C Automatic Data Acquisition/
Control System**

Price

\$10,000

- 5½ Digit Measurement
- Graphics

- Data Analysis
- Graduated Software

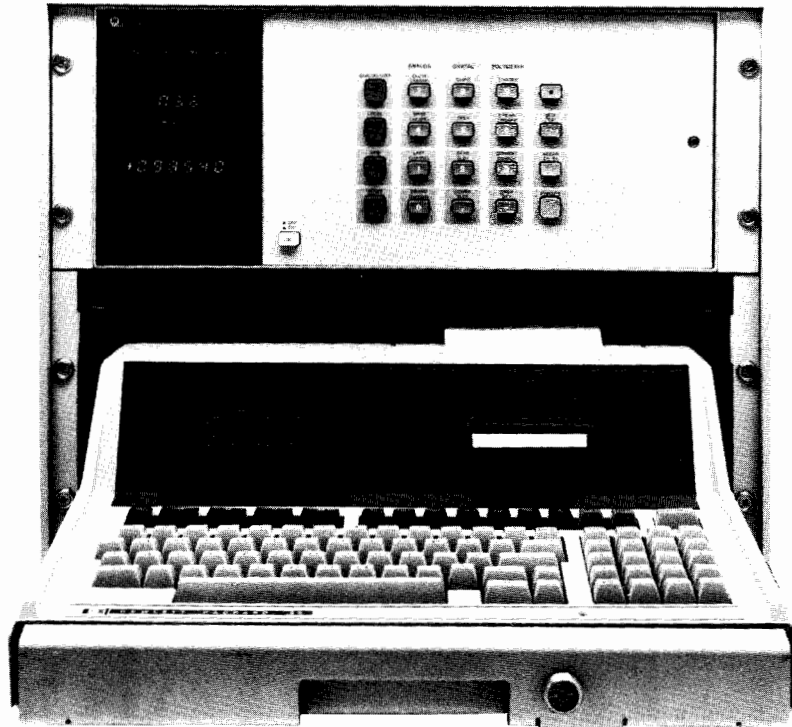

Description

The 3054DL consists of a precise measurement unit housed inside an attractive locking cabinet. When you add the computational capability of the 85F scientific computer, the combination becomes more than just a data logger—it becomes a complete scientific measurement station with data and program storage, graphics and excellent measurement performance.

The Measurement Unit contains a 5½ digit digital voltmeter with a dc current source for ohms measurements as well as a 5-slot mainframe for optional plug-in assemblies. Each slot accepts either a counter, a low-thermal multiplexer, a thermocouple multiplexer, a digital input card or a digital output (alarm relay) card. Advanced noise-rejection techniques such as Multi-Slope Integration and Tree Switching compliment the 1 microvolt sensitivity of the voltmeter.

The 85F Computer is not only a system controller, it is a full function BASIC language scientific computer with data analysis capabilities, graphics CRT and printer, and a built-in tape cartridge for both data and program storage.

Temperature Measurements, whether made with thermocouples, RTD's or thermistors, are all specified in terms of total system accuracy. The thermocouple reference junction is located on the connector block and is read automatically via the data logger software.

Resistance can be measured in a 4-wire configuration to eliminate the effects of lead wire resistance.

The Reciprocal Counter accepts logic-level inputs and can operate in either a period measurement mode or a totalize mode.

Digital Inputs and Digital (alarm relay) Outputs are available for monitoring switch positions and controlling external devices.

Graduated Software

The program, or "software" that instructs the measurement unit is stored on a magnetic tape cartridge in the 85F computer. This software flexibility allows you to choose any one of the three programming methods that fits your need best:

```

CHANNEL 01 FUNCTION SELECT

DCV--autoranging dc voltage
kΩ--autoranging resistance
J---type J thermocouple
K---type K thermocouple
T---type T thermocouple
SKIP--NO FUNCTION

-----
J           K           T           SKIP
           DCV          kΩ
  
```

Level 1: Menu entry . . . no programming language required

```

COMMANDS  HELP,NEW,GET,SAVE,LIST
          CHANGE,TIMING,RUN

channel: function [label]
[=linearization] [limit/action]
[ ]
EXAMPLE  1,3,6-9 10V/DEG K=-273+
100X;>100,DC4,0;<95,DC4,0

CHANNEL SETUP SAVED---THERMO
1: 1-87 J
?
_
  
```

Level 2: Line entry . . . no computer language required . . . just enter data logger information



```

10 ' SUBPROGRAM Busc1 hp85 rev A
80 07/17
20 ' P1=Min,P2=Max,P3=Offset,P4=
Min,P5=Max,P6=Tick
30 R3=512*(P1-P2) ' Min-Max
40 IF R3<>0 THEN 230 ' Abort
50 ON ERROR GOTO 210
60 08=ABS(P2-P1) ' Range
70 07=1P*(08) ' Power
80 06=08-18-07 ' Norm
90 05=10*(06)=5)+5*(06<5 AND 06)
=2)+2*(06<2 AND 06>1)+*(06<-1)
100 04=05*10*(07-1) ' Inter
110 03=SGN(P1-P2) ' Direction to
round
120 03=(P1-P3) 10-07
    
```

Subroutine... enter a short BASIC program that uses prewritten subprograms

	Level 1	Level 2	Level 3
dc Volts, k ohms	X	X	X
J, K, T Thermocouples	X	X	X
E, R, S Thermocouples		X	X
B, Nn Thermocouples			X
385 Platinum RTD		X	X
2252 Thermistor		X	X
Labels	X	X	X
Limits, Alarms		X	X
Log 30 Channels	X	X	X
Log up to 100 Channels		X	X
Frequency, Totalize		X	X
Histograms, Graphs		X	X
Strip Chart		X	X
User Definable Functions		ax + b aebx a + blnx ax ^b	Custom Program- ing. Up to 42 Functions
Customer Programs			X

Graphic Presentation is the key to understanding the data. From the graphic display to the program flexibility to the precise measurement capability, the 3054DL is the complete data logger.

Graphical Plotting—It Tells the Whole Story

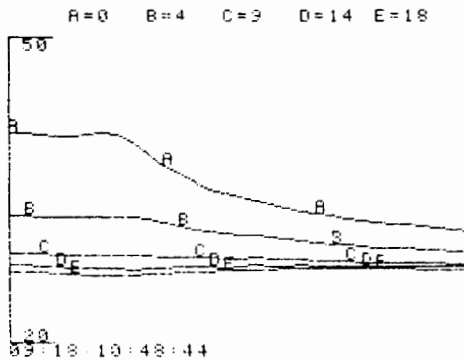

3054DL Specifications

The following specifications include all contact resistances, contact voltages and dvm errors. Accuracy specifications apply when the 3054DL is in an ambient environment of 23°C ± 5°, <85% R.H. Temperature coefficients are applied when the ambient temperature is 0 to 18°C or 28 to 50°C.

DC Voltmeter (Use Option 010 or 020):

Ranging: Auto or fixed range
A/D Technique: Integrating
Maximum Input Voltage: Hi to Lo: ±120 V peak
Lo to Guard: ±170 V peak
Any terminal to Chassis: ±170 V peak

Range	Maximum Reading	Resolution	Accuracy (90 days) (%Rdg.+Counts)	Temperature Coefficient (%Rdg.+Counts)/°C	Z _{in}
1 V	.119999	1 μV	.007 + 5	.0025 + .15	>10 ¹⁰
1 V	1.19999	10 μV	.006 + 2	.0002 + .02	>10 ¹⁰
10 V	11.9999	100 μV	.006 + 1	.0002 + .01	>10 ¹⁰
100 V	119.999	1 mV	.006 + 1	.00025 + .03	10 MΩ ± 0.5%

For >90 days, add 10 ppm/month to accuracy

Normal Mode Rejection: 60 dB (50 or 60 Hz ± .1%)

Effective Common Mode Rejection:

ac: 150 dB (50 or 60 Hz ± .1%)
dc: 104 dB (100 Channels)

Ohmmeter (Use Option 010 or 020):

Type: 2-wire or 4-wire
Current Source: Floating

Range	Maximum Reading	1 Count Resolution	Current Through Unknown	Accuracy (90 days) (%Rdg.+Counts)	Temperature Coefficient (%Rdg.+Counts)/°C
100 Ω	119.999	1 mΩ	1mA	.032 + 5	.0028 + .15
1 kΩ	1.19999	10 mΩ	100 μA	.032 + 5	.0028 + .15
10 kΩ	11.9999	100 mΩ	10 μA	.032 + 5	.0028 + .15
100 kΩ	119.999	1 Ω	10 μA	.031 + 2	.0027 + .02

For >90 days, add 20 ppm/month to basic accuracy

Options:

3054DL: Includes 5½ digit DVM, current source, real time clock, HP-IB interface, sliding drawer and cabinet, software Levels 1 & 2, and pre-initialized data tape **Price** \$5300

Option # (Choose up to 5 total option cards—3054DL capacity is 5 slots)

010: 20 channel guarded input relay card \$575

020: 19 channel guarded input relay card with thermocouple compensation. Measures JKERST thermocouples or dc volts \$700

050: 16 channel optically isolated digital input \$525

060: Frequency counter, totalizer \$500

110: 16 channel digital output actuator relay card \$650

230: Clock format: Mo:Day:Hr:Min:Sec N/C

231: Clock format: Day:Mo:Hr:Min:Sec N/C

260: Delete scanner display and controls --\$350

Choose one power line option:

315: 100 Volts; 50 Hz N/C

316: 100 Volts; 60 Hz N/C

325: 120 Volts; 50 Hz N/C

326: 220 Volts; 50 Hz N/C

335: 220 Volts; 60 Hz N/C

336: 220 Volts; 60 Hz N/C

345: 240 Volts; 50 Hz N/C

346: 240 Volts; 60 Hz N/C

400: Delete locking cabinet with sliding drawer -\$850

841: Add Level 3 software for custom data acquisition programs \$400

910: Extra set of Level 1 & 2 software (one set comes with 3054DL at no charge) \$200

Computer (Order both items to complete the 3054DL)

85F: Computer with CRT, printer, keyboard, graphics, \$3985

magnetic tape drive, 82937A HP-IB I/O card, 00085-

15003 I/O ROM, 82936A ROM Drawer

82903A: 16K Memory Module \$295

DATA ACQUISITION, TEST & CONTROL SYSTEMS

Data Acquisition/Control Unit

Model 3497A

- Relay Multiplexing
- DVM
- Real Time Clock
- Bridge Completion
- Digital Inputs/Outputs
- Counter
- Programmable D/A's
- Optional RS 232C Interface

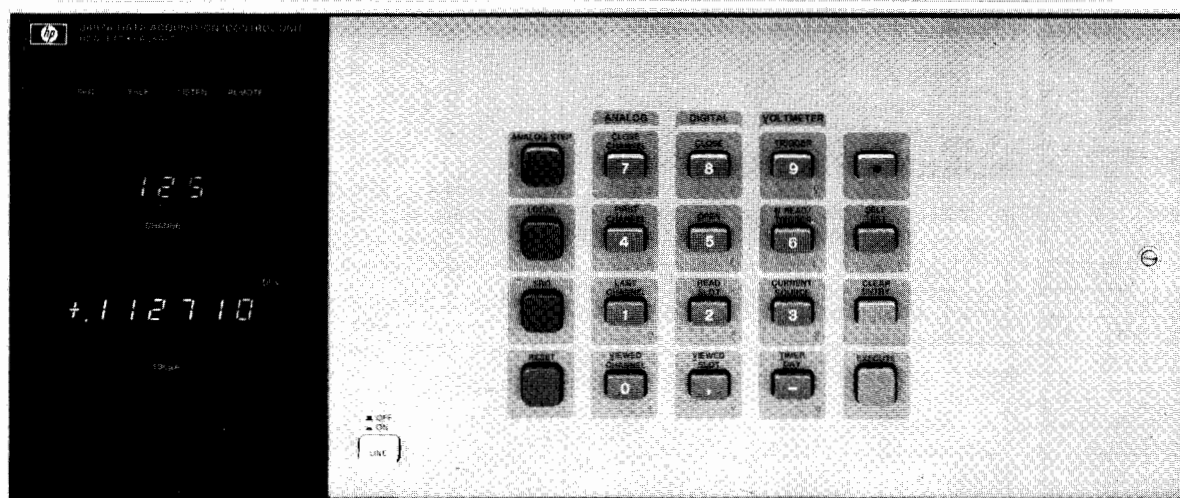

3497A

Description

The 3497A Data Acquisition/Control Unit combines the capabilities of several instruments and is a basic building block of an automatic data acquisition and control system. The 3497A will be used in an HP-IB automated system and can be viewed as a precision measurement and control computer peripheral.

The 3497A has been designed to be a very versatile and very powerful instrument. A basic 3497A consists of a mainframe that includes a front panel keyboard and display, a non-volatile real time clock, and an HP-IB interface. Available as an option is a 5½ digit integrating digital voltmeter and current source that occupies a dedicated slot in the 3497A chassis. Capability is added to the 3497A by using any combination of plug-in assemblies. Available plug-in assemblies are:

- Relay Multiplexers with or without thermocouple compensation
- Digital Input/Interrupt
- Counters
- Strain gage/bridge completion
- Actuators
- Programmable voltage and current D/A's

Up to 5 assemblies can be added to a 3497A and the 3498A Extender chassis can hold up to 10 more plug-in assemblies.

High Performance

The 3497A DVM can resolve 1 microvolt signals and is ideal for the precise measurement of the outputs of thermocouples, strain gauges and other transducers. Included on the DVM is a programmable current source that allows four terminal resistance measurements. The multiplexer assemblies switch 3 wires (Hi, Lo, and Guard) and add less than 2 microvolts of thermal offset to the measured signal.

Flexible Hardware Configuration

The 3497A card cage can hold 5 of any combination of the plug-in assemblies. This allows the multiplexing of up to 100 3-wire inputs to the DVM in a single 3497A or a single 3497A might contain 60 mul-

tiplexer channels, 16 digital inputs, 16 actuator outputs, and a DVM. By using the 3498A Extender, up to 1000 analog channels and 1360 digital channels can be controlled, all at a single bus address.

Ease of Use

The 3497A keyboard and display make the 3497A very easy to use and makes debugging of a 3497A-based system easy. The calibration adjustments for the 3497A DVM are located behind a hinged front panel; this allows complete calibration of the DVM without removing it from the test rack. Connections to all of the 3497A assemblies are made using screw terminals, therefore eliminating the need for soldering.

Automatic Data Acquisition and Control Systems

The 3497A is an integral part of the 3054A/C Automatic Data Acquisition and Control Systems. The 3054A consists of a 3456A Digital Voltmeter for high accuracy measurements, a 3437A Systems Voltmeter for high speed measurements and a 3497A for multiplexing, digital I/O and control. The 3054A includes software compatible with the HP 85, 9825, 9835 or 9845 computers. The 3054C is similar to the 3054A but it does not include the 3437A and the software is compatible with the HP 1000 series of computers. The 3497A is also a part of the 3054 DL data logger.

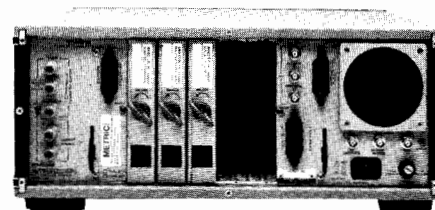



Real Time Clock

The 3497A mainframe includes a quartz referenced non-volatile real time clock. In addition to providing timing data, the clock can measure elapsed time, interrupt at a pre-settable time, and output a programmable pulse train.

Clock Format:

Month:Day:Hours:Minutes:Seconds (U.S. Format)
Day:Month:Hours:Minutes:Seconds (European Format)

Modes	Max. Time	Resolution	Accuracy
Real Time Mode:	1 year	1 second	± (.005% of time + .1 s)
Elapsed Time Mode:	10 ⁶ seconds	1 second	± (.005% of time + .1 s)
Time Alarm Mode:	24 hours	1 second	± (.005% of time + .1 s)
Time Interval Mode:	24 hours	1 second	± (.005% of time + .1 s)
Timer Output Mode:	1 second	100 μs	± .02% of time

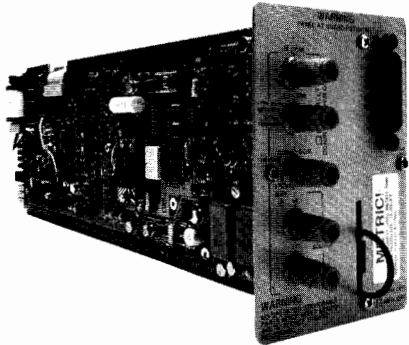

Option 001—5½ Digit DVM and Current Source

The 3497A DVM assembly is a systems quality, 5½ digit, 1 micro-volt sensitive DC Voltmeter. The DVM is fully guarded and uses an integrating A/D conversion technique; this yields excellent common and normal mode noise rejection.

Included on the DVM assembly is a three level programmable current source. The current source, when used simultaneously with the DVM, can be used to make high accuracy four terminal resistance measurements with 1 milliohm resolution.

The 3497A DVM assembly is fully programmable and can be configured to meet almost any measurement configuration. The 3497A DVM can be programmed for increased reading rates, obtaining a maximum of 50 readings per second in 5½ digit mode and 300 readings in 3½ digit mode. The number of readings per trigger and the delay between readings are programmable. Included on the DVM assembly is memory storage of up to sixty 5½ digit readings.

Voltmeter Ranges/Resolution

Range	Max. Display	5½ Digit Resolution	4½ Digit Resolution	3½ Digit Resolution	Max. Input Voltage
.10 V	±.119999	1 μV	10 μV	100 μV	120 V peak
1.0 V	±1.19999	10 μV	100 μV	1 mV	
10.0 V	±11.9999	100 μV	1 mV	10 mV	
100.0 V	±119.999	1 mV	10 mV	100 mV	

Voltmeter Measurement Accuracy

± (% of reading + Number of Counts)

Auto zero on:

90 Days: 23°C ± 5°C

Range	Digits Displayed		
	5½ Digits	4½ Digits	3½ Digits
.10 V	.007 + 3	.01 + 1	.1 + 1
1.00 V	.006 + 1	.01 + 1	.1 + 1
10.00 V	.006 + 1	.01 + 1	.1 + 1
100.00 V	.006 + 1	.01 + 1	.1 + 1

Input Impedance

High to Low (in parallel with 120 pF at 1 MHz) 25 °C, <85% R.H. 40 °C, <60% R.H. 40 °C, <95% R.H.

.1 V to 10 V Range	>10 ⁹	>10 ⁹
100 V Range	10 MΩ ± .5%	10 MΩ ± .5%

Maximum Input Voltage

High to low: 120 V peak

Low to guard: 170 V peak

Guard to chassis: 170 V peak

Current source

Accuracy: 90 days

Range	23°C ± 5°C
10 μA	2.5 nA
100 μA	25.0 nA
1 mA	250 nA

Compliance: > +15 volts

Isolation voltage: 170 volts peak

Output resistance: >10¹⁰ Ω

General Information

Maximum reading rate: (readings/second)

Auto Zero	60 Hz Operation Digits Displayed			50 Hz Operation Digits Displayed		
	5½	4½	3½	5½	4½	3½
ON	25	100	150	20	83	125
OFF	50	200	300	40	166	250

Delay: 0 to 99.9999 sec. in 100 μsec. steps

Buffer size: packed format: 100 readings; ASCII format: 60 readings

Number of readings per trigger: 1 to 999

Measurement Speeds

For the 3497A DVM and the relay multiplexer, speeds are given for measurements on random channels (using software channel selection) and sequential channels (using external hardware increment). Speeds include I/O times to the indicated computers.

60 Hz operation

	Voltmeter Digits Displayed	85A	9825T	9835A	9845T	HP1000
Sequential Channels	5½	39	40	40	40	30
	4½	97	100	100	100	88
	3½	116	120	120	120	107
Random Channels	5½	16	31	20	20	21
	4½	22	58	30	30	31
	3½	23	65	31	31	33

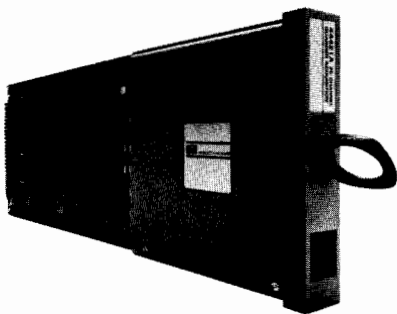

Option 010—20 Channel Relay Multiplexer

This assembly uses reed relays to multiplex signals to the DVM or other instruments. Each assembly switches 20 channels, each channel consists of HI, Lo, and Guard lines. Two channels may be closed per assembly and relays may be closed in a random sequence or incremented between programmable limits. The low thermal offset of the relays make it suitable for measuring the outputs of strain gauges and other transducers. Each channel can be configured with a filter or current shunt for additional flexibility.

Input Characteristics

- Maximum input voltage:** <170 V peak between any two input terminals
- Maximum current:** 50 mA per channel non-inductive
- Maximum power:** 1 VA per channel
- Thermal offset:** Direct Switched: <1 μ V Differential, Tree Switched: <2 μ V Differential
- Closed channel resistance:**
 - In series:** 100 Ω \pm 10% in High, Lo and Guard
 - Relays contacts only:** <1 Ω
- Open channel isolation:** >10¹⁰ Ω (Hi to Lo, 40°C, <60% R.H.)

- Maximum switch rate:** Random Channels: 38/second (using 9835A Computer); 475/second (using hardware increment)
- Rated switch life at 1 VA:** 10⁷ operations
- All relays are break-before-make**

Option 020—Relay Multiplexer with Thermocouple Compensation

The option 020 assembly uses the same relay multiplexer as option 010 but incorporates a special isothermal connector block to allow thermocouple compensation. Two types of compensation (selectable by the user) are available. A temperature-dependent voltage is generated for software compensation; this voltage is then used in a computer program to compensate the thermocouple voltage. Hardware compensation involves inserting a voltage in the measurement circuit that automatically compensates the thermocouple voltage.

Reference Junction Compensation Comparison

	Compensation Type	
	Software	Hardware
Compatible Thermocouples	Any mixture	One of the following types: B,E,J,K,R,S,T
Measurement channels available per assembly	19	20
Reference junction compensation accuracy (23° C \pm 5° C)	.1°C	

Option 050—16 Channel Isolated Digital Input/Interrupt

The option 050 assembly can sense up to 16 channels of digital data. The first 8 channels can also be used as interrupt lines to detect transient signals. The assembly can accept a wide range of input levels and all functions and masks are fully programmable. A five volt supply is provided for driving external contact closures and open collector outputs.

Input signal characteristics:

Input Level	Low Voltage Maximum	High Voltage Minimum	Maximum Input Voltage Between High & Low Terminals	Minimum Input Current
5 V	0.8 V	2.4 V	30 V	400 μ A
12 V	3.0 V	7.0 V	42 V	1 mA
24 V	6.0 V	13.0 V	42 V	2 mA

Maximum voltage between any terminal and chassis: \pm 170 V peak

Logic polarity: Positive True (Negative True is Jumper Selectable)

Handshake:

- Gate handshake line is isolated, open collector output.
- Flag handshake line is isolated, 5 V, 12 V, or 24 V input

Interrupt Mode (Bits 0-7)

- Minimum pulse width:** 100 microseconds
- Triggering:** Each interrupt line is individually programmable for positive or negative edge triggering.
- Masking:** Each interrupt line may be enabled or disabled using a programmable mask.

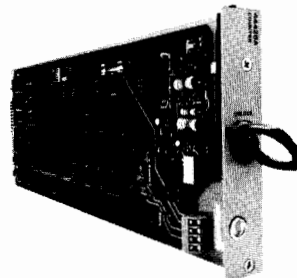

Option 060—100 kHz Reciprocal Counter

This option can be used to measure mechanical and low frequency electronic signals. The counter can measure the period of signals up to 100 kHz and the pulse width of signals down to 18 μ s. The counter can also count up or down from a programmable start point. It can accept a wide variety of input signals including CMOS, open collector TTL and passive contact closures.

The counter is very flexible and can be configured for many measurement configurations. Some features are:

- Programmable Edge Triggering
- Isolated or Non-isolated Input
- Hardware and Software Interrupts
- 5 Volt Supply for sensing contact closures
- Programmable Pulse Output

All counter functions, interrupts and trigger modes are fully programmable. The counter can be reading during a measurement or can be programmed to respond when a measurement is complete.

Input Signal Characteristics:

Input Levels:

Input Level Range	V(Lo) (Maximum)		V(Hi) (Minimum)	
	Isolated	Non-iso	Isolated	Non-iso
5V	1.0V	1.0V	4.2V	4.2V
12V	1.8V	2.7V	10.3V	8.0V
24V	2.6V	6.0V	18.4V	16.5V

(5V level is standard, 12 and 24 volt levels are jumper selectable. Other voltages can be accepted using customer supplied resistors.)

Input Circuit: Switch selection of optically isolated or non-isolated input. Non-isolated input has 19.5 k Ω minimum input impedance. Non-isolated mode is standard.

Maximum Isolation Voltage: 170 V peak between any terminal and ground. Isolated mode only.

Period Mode:**Input Signal Characteristics:****Maximum Input Frequency:** 100 kHz**Minimum On Time:** 5 μ s**Minimum Off Time:** 5 μ s**Range Characteristics:**

Range	Least Significant Digit (LSD)	
	HP-IB	Display
9999.999 s	1 ms	10 ms
99.99999 s	10 ms	100 μ s
0.9999999 s	100 ns	1 μ s
.09999999 s	10 ns	1 μ s

Accuracy: \pm (.01% of reading + 2 LSDs + Trigger Error)**Trigger Error:** Maximum Transition Time for input voltage to go from V(Lo) to V (Hi) or V(Hi) to V(Lo)**Pulse Width:****Input Signal Characteristics:****Minimum Start to Stop time:** (Pulse Width): 18 μ s**Minimum Stop to Start Time:** 18 μ s**Range Characteristics:**

Range	Least Significant Digit (LSD)	
	HP-IB	Display
9999.999 s	1 ms	10 ms
99.99999 s	10 μ s	100 μ s
0.999999 s	1 μ s	1 μ s
.099999 s	1 μ s	1 μ s

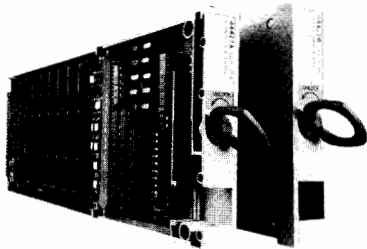
Accuracy: \pm (0.1% of reading + Trigger Error + (2 LSDs or 18 μ s, whichever is greater)).**Trigger Error:** Maximum Transition Time for input voltage to go from V(Lo) to V(Hi) + V(Hi) to V(Lo)**Totalize/Down Count Mode:****Input Signal Characteristics:****Maximum Input Frequency:** 100 kHz**Minimum Pulse Width:** 5 μ s**Range:** 0 to 999,999**Option 070— 120 Ohm Strain Gage / Bridge Completion Assembly****Option 071— 350 Ohm Strain Gage / Bridge Completion Assembly**

The option 070/071 assemblies may be used to provide bridge completion for measuring strain gages, RTD's pressure sensors and load cells. Each card uses an internal shared half bridge and can complete 10 channels of $\frac{1}{4}$ and $\frac{1}{2}$ and full bridges in any combination. When used with a +5V excitation supply (such as the HP 6214A) and the 3497A DVM, the assembly provides .1 μ E sensitivity with 1 μ E accuracy. Provisions are made for shunt calibration and checking gage leakage and lead resistance.

Adjustment and calculation of the bridge equation are done in the system controller. Specific software to support the use of the assembly is supplied with the 3054A/C systems. Option 070 completes 120 ohms bridges while option 071 completes 350 ohm bridges.

Specifications**Sensitivity:** (with excitation voltage at 5 volts)

Bridge Type	3497A DVM	3456A DVM	Range at Best Resolution
$\frac{1}{4}$.4 μ E	.04 μ E	42400 μ E
$\frac{1}{2}$.2 μ E	.02 μ E	21200 μ E
Full	.1 μ E	.01 μ E	9500 μ E

Accuracy: These specifications include all system-related errors: bridge resistor tolerance and drift, thermal offsets of bridge, scanner and voltmeter, voltmeter accuracy, injected currents, self-heating of bridge resistors and system noise. The only exceptions are lead wire mismatch and the accuracy of the gage itself. Specifications are valid for either the 3456A and the 3497 DVM with one line cycle integration. The specifications assume a gage factor of 2. (All specifications are \pm the value shown and assume an excitation voltage of +5 V.)

Bridge Type	24 Hour 23°C \pm 1°C	90 Day 23°C \pm 5°C	\geq 90 Days 23°C \pm 5°C
$\frac{1}{4}$	7 μ E	25 μ E	1.80 μ E/Mo.
$\frac{1}{2}$	4 μ E	5 μ E	.40 μ E/Mo.
Full	1 μ E	1 μ E	.04 μ E/Mo.

Excitation Supply Requirements:**V max:** 5.4 Vdc**I (out):** 250 mA per 10 channels (120 ohm gages)**Option 110 16 Channel Actuator****Option 115 8 Channel High Voltage Actuator**

There are two actuator assemblies that can be used in 3497A based systems to switch control signals and voltages:

Option 110 consists of 16 mercury wetted form C (single pole-double throw) relays. Each relay can be individually closed and can switch one amp at 100 volts. The actuator assembly can be used to switch test fixture power or to actuate alarm bells. This flexibility of this assembly allows it to be used as a digital output or matrix switch.

Option 115 is an 8 channel high voltage actuator assembly. This assembly will be used to switch voltages up to 252 VRMS and currents up to 2 amperes. This capability makes the Option 115 assembly ideal for switching power line voltages to small motors, alarm bells and lights, motor starters and solenoids.

Option 110 and 115 Specifications

	Option 110	Option 115
Switch Form	C	A
Contact Type	Mercury Wetted	Dry
Number of channels	16	8
5 Volt Pullup for digital output	Yes	No
Maximum Voltage	100 V Peak	252 VRMS 48 VDC
Maximum Current	1 amp	2 ARMS or DC
Maximum Power	100 VA	500 VA AC 60 VA DC
Isolation Voltage	170 V Peak	400 V Peak input to output 1500 VRMS to chassis



Model 3947A (Cont.)

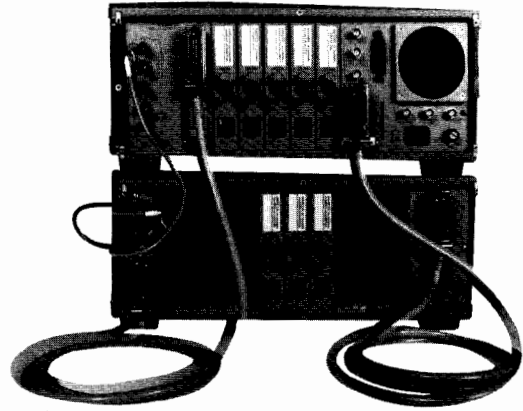
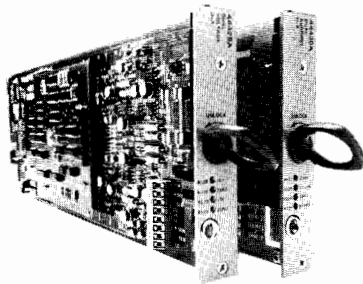

Option 120—Dual Voltage D/A
Option 130—Dual Current D/A

Option 120 consists of two 0 to ± 1 10V programmable voltage sources. These sources can be used to provide a programmable test stimulus or to control voltage programmed devices like power supplies and VCO's. The output voltage can be remotely sensed to compensate for voltage drop in the leads.

Option 130 consists of two 0 to 20 mA or 4 to 20 mA programmable current sources. These sources, especially when using the 4 to 20 mA range, can be used as transmitters in industrial current loops and can drive up to 600 ohms of total loop resistance.

Each voltage and current source is isolated from the other and ground. Isolation breaks possible ground loops and permits control of devices that are floated up to 170 volts above ground.

Option 120 Specifications:

- Output:** 13 bits including polarity
- Least Significant Bit:** 2.5 mV
- Output Range:** -10.2375 V to +10.2375 V
- Accuracy:** (using remote sense)
- 24 Hours:** 23°C ± 1 °C: $\pm .025\%$ of programmed value ± 2.5 mV
- 90 Days:** 23°C ± 5 °C: $\pm .070\%$ of programmed value ± 4.0 mV
- Temperature Coefficient:** (0 to 18°C, 28 to 50°C) $\pm .0045\%$ of programmed value/°C $\pm 100 \mu\text{V}/^\circ\text{C}$
- Ripple and Noise:** 2.5 mV rms, 20 Hz to 250 kHz into 1 k Ω
- Load Regulation:** 600 μV (0 to 15 mA)
- Maximum Output Current:** 15 mA (output within specifications)

Option 130 Specifications:

- Output:** 12 bits
- Least Significant Bit:** 5 μA (0 to 20 mA range)
4 μA (4 to 20 mA range)
- Output Range:** 0 to 20.475 mA to 20.380 mA (each source jumper selectable)
- Accuracy:**
- 24 Hours:** 23°C ± 1 °C: $\pm 0.03\%$ of programmed value $\pm 5.5 \mu\text{A}$
- 90 Days:** 23°C ± 5 °C: $\pm 0.07\%$ of programmed value $\pm 10.0 \mu\text{A}$
- Temperature Coefficient:** (0 to 18°C, 28 to 50°C): $\pm .0075\%/^\circ\text{C}$ or programmed value $\pm 650 \text{ nA}/^\circ\text{C}$
- Ripple and Noise:** 5 μA rms, 20 Hz to 250 kHz into 100 ohms
- Compliance Voltage:** 12.0 volts
- Load Regulation:** $\pm 2.0 \mu\text{A}$ (2.0 V to 12.0 V)

Option 232 RS232C Interface

Option 232 to the 3497A deletes the standard HP-IB interface and adds an RS232C (CCITT/V.24) compatible interface. The option 232 interface is also compatible with the new RS423 (CCITT/V.10) version of the RS449 interface.

The option 232 interface allows you to remotely locate the 3497A. When used with an RS423 compatible computer the 3497A can be located up to 1200 meters away from the computer. When used with full duplex asynchronous MODEMs the 3497A can be located anywhere there are available telephone lines. Option 232 provides 8 data rates from 110 to 19,200 BPS with even or odd parity and a 7 or 8 bit character length. HP technical brochure part number 5952-8884 contains additional information on 3497A option 232.

Option 298—3498A Extender

The 3498A Extender chassis allows low cost expansion of 3497A-based systems. Each 3498A can hold up to ten 3497A plug-in assemblies. Use of one or more 3498A's requires a 3497A (for control); all required connecting cables are supplied with the 3498A.

Number of slots per 3498A: 10

Maximum number of added analog multiplexer channels (options 010, 020, 030, 040): 900 channels (45 assemblies)

Maximum number of added non-analog acquisition assemblies (options 050, 060, 110, 120, 130): 85 assemblies

Maximum number of 3498A's per 3497A: 13

General

Size (3497A or 3498A): 190.5 mm H x 428.6 mm W x 520.7 mm D (7½" x 16⅞" x 20½"). Additional 2" in depth should be allowed for wiring.

Net weight: 3497A, 20.4 kg (45 lbs.) and 3498A, 20.4 kg (45 lbs.) with assemblies in all slots.

Shipping weight: 3497A and 3498A maximum with assemblies in all slots are 26.3 kg (26.3 lbs.)

Environmental (3497A or 3498A):

- Operating temperature: 0°C to 55°C
- Non-operating temperature: -40°C to 75°C
- Humidity: to 95% at 40°C except as noted
- Operating power: switch selection of 110, 120, 220 and 240 volts $\pm 10\%$, 48-66 Hz, 150 VA 3497A and 3498A.

Ordering Information

Ordering Information	Price
Opt 001 5½ digit DVM and Current Source	\$1575
To field install, order 44420A kit	
Opt 010 20 channel Relay Multiplexer Assembly	\$575
To field install, order 44421A kit	
Opt 020 Relay Multiplexer Assembly with thermocouple compensation; to field install, order 44422A kit	\$700
Opt 050 16 channel isolated Digital Input/Interrupt Assembly; to field install, order 44425A kit	\$525
Opt 060 100 kHz Reciprocal Counter; to field install, order 44426A kit	\$500
Opt 070 120 Ohm Strain Gage/Bridge Completion Assembly; to field install, order 44427A kit	\$800
Opt 071 350 Ohm Strain Gage/Bridge Completion Assembly; to field install, order 44427B kit	\$800
Opt 110 16 channel Actuator/Digital Output Assembly; to field install, order 44428A kit	\$650
Opt 115 8 Channel High Voltage Actuator Assembly; to field install, order 44431A Kit	\$475
Opt 120 Dual Output 0 to ± 10 V D/A Converter Assembly; to field install, order 44429A kit	\$950
Opt 130 Dual Output 0 to 20/4 to 20 mA D/A Converter Assembly; to field install, order 44430A kit	\$900
Opt 230 Clock Format (Month:Day:Hours:Min:Sec)	N/C
Opt 231 Clock Format (Day:Month:Hours:Min:Sec)	N/C
Opt 232 Delete HP-IB Interface, add RS232C Interface	\$159
Opt 260 Delete Keyboard and Display	less \$350
Opt 298 Add 3498A Extender & connecting cables; to field install, order as a 3498A, not as a 3497A Opt 298	\$1700
Opt 315-346 Power and Frequency Options:	N/C
Opt 907 Front Handle Kit (5061-0090)	\$40
Opt 908 Rack Flange Kit (5061-0078)	\$30
Opt 909 Rack Flange & Front Handle Kit (5061-0084)	\$65
Opt 910 Extra Set of 3497A/3498A Documentation	\$60
3497A Data Acquisition/Control Unit	\$2750

- Low level switching
- Multichannel closure
- Switched guard
- Relay actuation

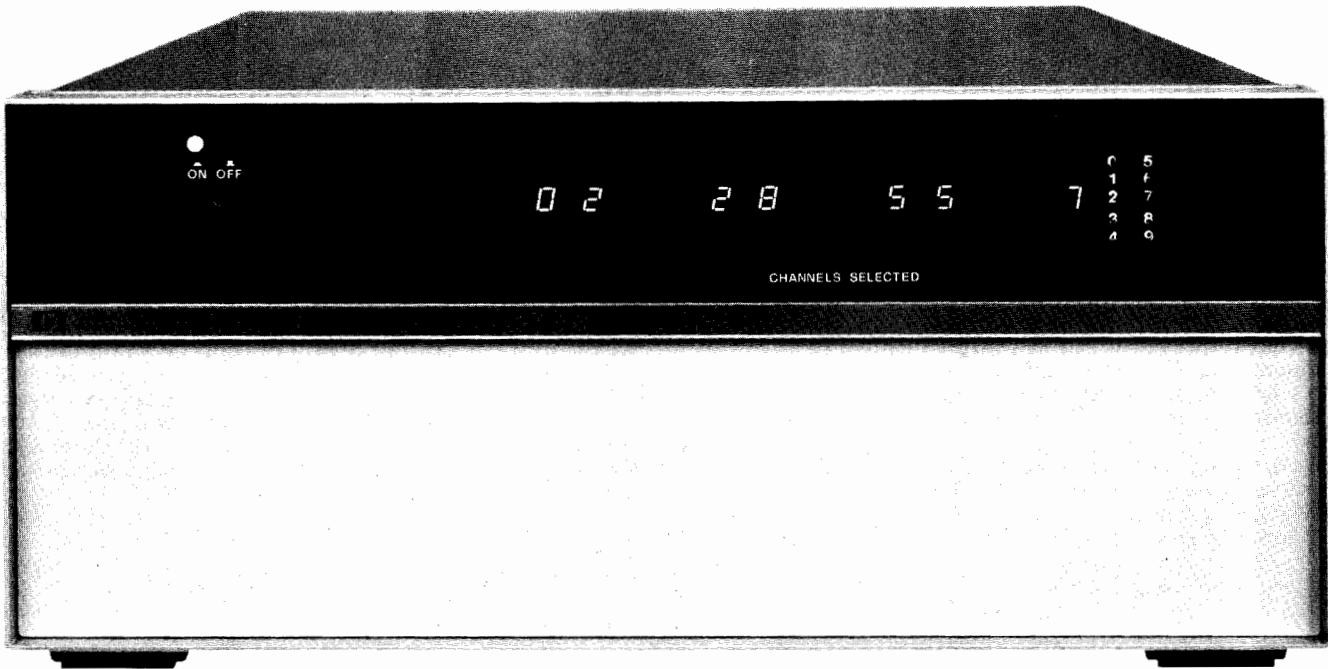

3495A



Description

General

The 3495A Scanner switches analog input signals to an appropriate measuring device (voltmeter). It can also control external devices with relay actuator closures. Ideal for many data logging and data acquisition applications, the scanner can be used for sequential or random scanning. Any Hewlett-Packard Interface Bus (HP-IB) compatible controller can be used to operate the Scanner. Any combination of four relay assemblies (discussed below) can be used per scanner mainframe. More than four assemblies requires additional scanner mainframes.

Five optional relay assemblies are available with the scanner, four low thermal assemblies and one actuator assembly.

to 230V peak. A separate guard relay for each channel minimizes the effects of common mode voltage on low level measurements. A break-before-make feature ensures that only one channel at a time is closed, which prevents connecting two inputs simultaneously.

Maximum contact ratings: Voltage: 200V peak; Current: 200 mA (non-inductive); Maximum input voltage: 230V peak; Thermal Offset: $< 2\mu\text{V}$ differential EMF; Isolation: $> 10^{10}\Omega$; Switching Time: 10 ms max.

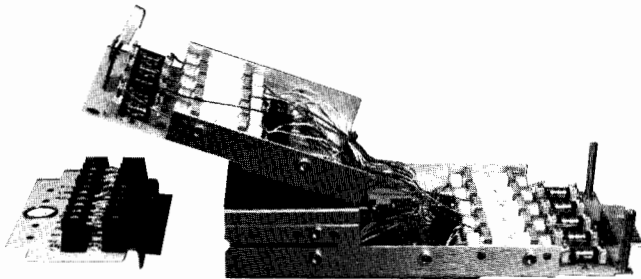

OPTION 001

Low Thermal Relay Assemblies

Applications: low level dc measurements; dc volts and resistance scanning.

Transducer sensing: thermocouples, thermistors, strain gauges, pH meters.

1. Ten Channel Low Thermal Relay Assembly (Opt. 001): This assembly provides ten 3-wire input channels for switching voltages up

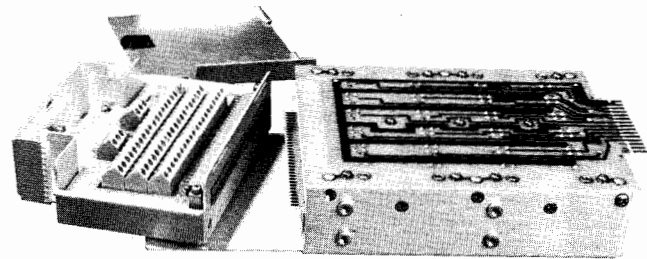

OPTION 004

2. Twenty Channel Low Thermal Relay Assembly (Opt. 004):

Designed for switching voltages below 42V peak, this assembly contains twenty 3-pole input channels. Very low thermal offset voltages are maintained in the assembly for low level switching. When used in conjunction with the High Speed Controller Board (Opt. 100) and the 3437A System Voltmeter, switching speeds of up to 1000 channels/s with $100\mu\text{V}$ resolution can be obtained.

Maximum contact ratings: Voltage: 42V peak; Current: 40mA (non-inductive); Maximum input voltage: 42V peak; Thermal Offset: $< 1\mu\text{V}$ differential EMF; Isolation: $> 10^{10}\Omega$; Switching Time: 1 ms max.

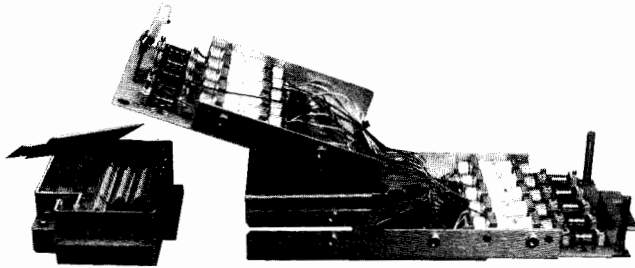

Option 003

3. Nine Channel Reference Assembly with Thermocouple Compensation (Opt. 003): An isothermal block, which replaces the standard terminal connector, acts as a reference junction for up to nine thermocouples. The remaining channel measures the temperature of the reference junction with a built-in thermistor. This temperature information is used for thermocouple reference junction compensation.

Maximum contact ratings: Voltage: 42V peak; Current: 200mA (non-inductive); Maximum input voltage: 42V peak; Thermal offset: $2\mu\text{V}$ differential EMF; Isolation: >math>10^9\Omega</math>; Switching Time: 10 ms max.

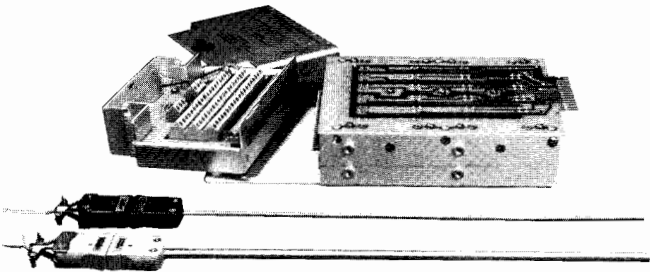

Option 005

4. Nineteen Channel Reference Assembly with Thermocouple Compensation (Opt. 005): similar in operation to Option 003 except there are nineteen low thermal channels instead of nine channels. When used in conjunction with Option 100 and the 3437A SVM, switching speeds of up to 1000 channels/s with 100 μV resolution can be achieved.

Maximum contact ratings: Voltage: 42V peak; Current: 40 mA (non-inductive); Maximum input voltage: 42V peak; Thermal offset $1\mu\text{V}$ differential EMF; Isolation: >math>10^9\Omega</math>; Switching time: 1 ms max.

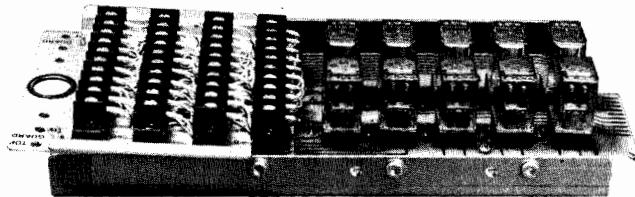

Option 002

Relay Actuator Assembly

Applications: process control, actuate visual or audio indicators, control high current relays, up to 2 X 5 X 2 Matrix switching.

Ten Channel Relay Actuator Assembly: This relay actuator assembly provides ten independently programmable 2-wire closures for controlling high current relays, distributing low current dc or ac voltages, or external control function. Each two-pole relay can switch currents up to 2 A rms. Any combination of channels on this assembly may be closed or opened simultaneously.

Maximum contact ratings: voltage: 100V rms; Current: 2 A rms; Maximum input voltage: 230V peak; Thermal offset: $30\mu\text{V}$ differential EMF; Switching time: 40 ms max. (Caution: For use in cir-

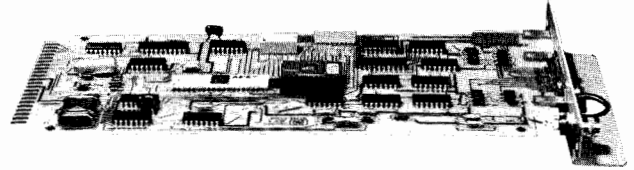

Option 100

cuits fused at 2 amperes or less and less than 200 VA).

High Speed Control Board (Opt. 100): Replacing the standard control board with the High Speed Control Board adds high speed capability to the 3495A Scanner. When Opt. 004 or Opt. 005 low thermal assemblies are used in conjunction with an external triggering device, such as a 3437A System Voltmeter, speeds of up to 1000 channels/s with 100 μV resolution can be obtained. The High Speed Control Board is compatible with other relay assemblies, but no speed improvements are achieved.

General

Operating temperature: 0°C to +55°C

Humidity range: 95% R.H., 0°C to +40°C

Power: 100/120/220/240 +5%, -10%

48 to 66 Hz line operation, 100VA

Size: 190.5 H x 428.6 W x 520.7 mm D (7.5" x 16.87" x 20.5").

Weight: Depends on options. Net: 18 kg (39.6 lbs.) maximum with four relay assemblies. Shipping: 22 kg (48.4 lbs.) maximum.

Options, accessories and field installation kits

Order one or more optional relay assemblies to obtain desired number of channels. Up to a total of four assemblies may be used in any combination in each scanner mainframe.

Option	Price
001: Ten Channel Low Thermal Relay Assembly	+\$750
002: Ten Channel Relay Actuator Assembly	+\$525
003: Nine Channel Reference Assembly With Thermocouple Compensation	+\$850
004: Twenty Channel Low Thermal Relay Assembly	+\$850
005: Nineteen Channel Reference Assembly With Thermocouple Compensation	+\$950
100: High Speed Control Board	+\$375

Field Installation Kits

44401A Ten Channel Low Thermal Relay Assembly	+\$750
44402A Ten Channel Relay Actuator Assembly	+\$525
44403A Nine Channel Reference Assembly With Thermocouple Compensation	+\$850
44404A Twenty Channel Low Thermal Relay Assembly	+\$850
44405A Nineteen Channel Reference Assembly With Thermocouple Compensation	+\$950
44413A High Speed Control Board	+\$375

In addition, options 001 or 004 can be field modified to include thermocouple compensation by ordering the appropriate terminal connectors.

Additional terminal connectors for:

Ten Channel Low Thermal Relay Assembly 03495-64101	+\$145
Ten Channel Relay Actuator Assembly 03495-64104	+\$82.50
Nine Channel Thermocouple Reference Assembly 03495-64103	+\$330
Twenty Channel Low Thermal Relay Assembly 03495A-64114	+\$175
Nineteen Channel Thermocouple Reference Assembly 03495-64115	+\$220

3495A Scanner **\$1750**



Use the MULTIPROGRAMMER to get exactly what you want when building your own Automatic System.

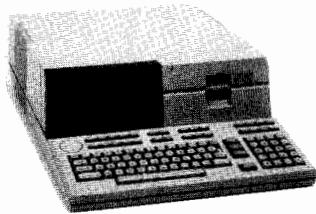

HP Desktop Computer

First, Select your HP Controller and Interface Kit ... Use either a Desktop or Minicomputer ...

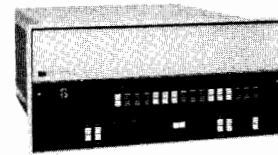

HP Minicomputer



Then select from a wide range of these MULTIPROGRAMMER CARDS for the MAINFRAMES ...

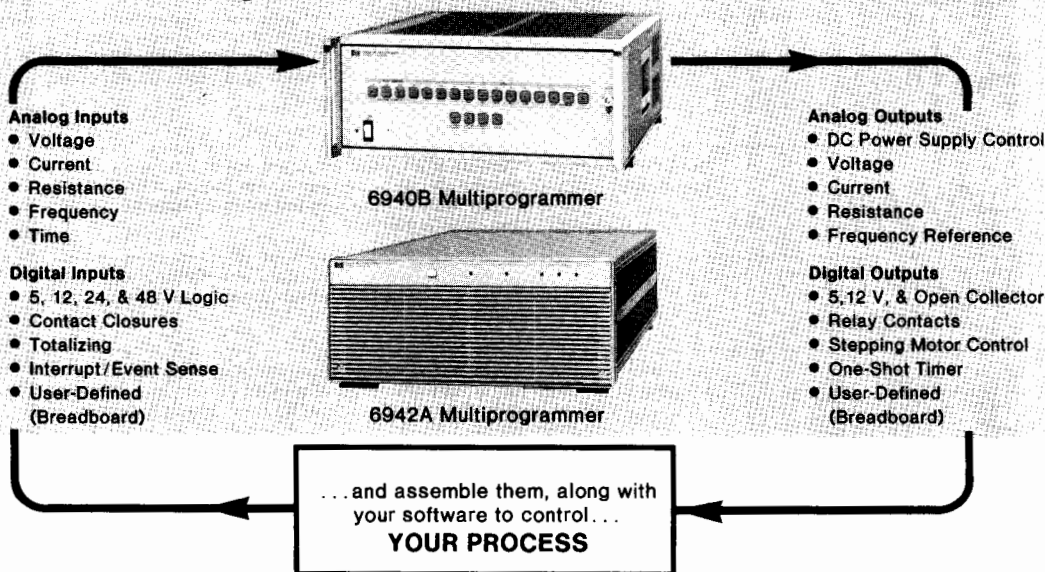

Introduction

The Multiprogrammer is the vital link between a Hewlett-Packard Desktop Computer or Minicomputer and your test or process. The Multiprogrammer provides the interface between the controller and the physical world. Thousands of Multiprogrammers are in use now as part of user defined and assembled systems for production testing and control, data acquisition, process monitoring, life testing, quality control, and component evaluation.

The Multiprogrammer Family gives you the choice of two mainframes: The 6940B or the 6942A. The 6940B is the lower cost solution and can give the more advanced programmer maximum I/O speed. The 6942A is the latest addition to the family and offers simplified programming and some new, powerful I/O cards. The next five pages will give you more details to help you decide which of these two mainframes is the right one for your application.

6942A. The brochures include detailed specifications, applications, programming, interfacing, and ordering information. Ask your HP Field Engineer for publication 5952-4025 (for the 6940B) or 5952-4034 (for the 6942A), or use the card at the rear of this catalog.

Complete Technical Data

If you would like additional information on Multiprogrammer products we have a free, 60-page brochure on the 6940B and one on the

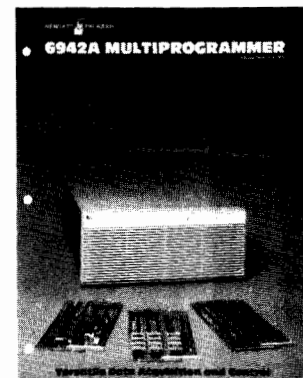
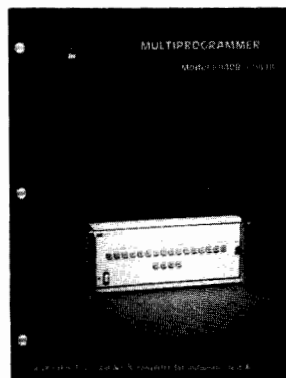

DATA ACQUISITION, TEST & CONTROL SYSTEMS

Multiprogrammer: Versatile Data Acquisition and Control

Model 6940B

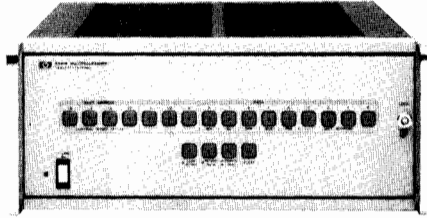

- Stimulus
- Measurement
- Control
- Data acquisition

Multiprogrammer I/O Card Function

	Functions	Applications	Cards Used
STIMULUS	<p>Programmable DC Voltage and Current</p>	The output voltage (up to 100V) and current (up to 1000A) of thirty-seven different HP power supplies can be programmed to provide bias in automatic test systems or control of electromechanical process equipment.	Resistance Output 69501A-69513A 69520A
	<p>Digital-to Analog Conversion</p>	Twelve bit voltage and current DAC's for strip chart, x-y, and analog tape recordings as well as control of analog programmable instruments and process control devices with 0.5 volt or 4-20 mA inputs.	Quad DAC, 69322A; Voltage DAC 69321B; Current DAC, 69370A; Regulator 69351B
	<p>Time and Frequency Reference</p>	One-shot timing pulses, programmable from 1 μ s to 40 days, and crystal-controlled pulse trains in fixed frequencies of 1, 10, 100, 1 K, 10 K, and 100 kHz serve as time base references for control, measurement, and data acquisition.	Timer/Pacer 69602A
MEASUREMENT	<p>Voltage, Current and Resistance Measurements</p>	Measure voltages in the presence of 100 V of common mode noise. Connecting a resistor across the input permits current measurements for 4-20 mA current loops used in process control. Combine voltage monitor and current DAC cards for resistance measurements.	High Speed A/D, 69422A; Low Level A/D, 69423A; Current DAC, 69370A; Regulator 69351B
	<p>Frequency Measurements</p>	The pulse counter card accumulates counts over a precise time interval when a programmable timer card is connected to the enable line of the counter. The program divides the count by the time interval to measure the frequencies from 200 kHz to 0.001 Hz.	Pulse Counter, 69435A, Timer/ Pacer 69602A
	<p>Pulse Counting Preset Up/Down</p>	Counter may be preset to any value within count range of 0 to 4095. The program can examine the counter without disturbing the counting process (read-on-the-fly).	Pulse Counter, 69435A.
	<p>Time Interval Measurement</p>	Elapsed time between two events can be measured in the range of 10 μ s to 1 hour by counting a known frequency over the unknown interval. The program divides the accumulated count by the known frequency to determine the interval.	Pulse Counter, 69435A; Timer/ Pacer 69602A
CONTROL	<p>Stepping Motor Control</p>	One output word to card produces from 1 to 2047 square-wave pulses at either of two outputs (CW or CCW) to control motor translators. Output pulses are also used for pulse train update of supervisory control stations.	Stepping Motor Control, 69335A.
	<p>Digital Output and Switching</p>	Twelve bits of data in TTL, open collector, or SPST relay-contact form provide digital control of instruments, indicators, and solid-state AC relays.	TTL, 69331A; Open Collector, 69332A; Relay Out, 69330A; Relay Out/Readback, 69434A.
ACQUISITION	<p>Scanning and Input Multiplexing</p>	The High Speed Scanner Card acts as an input multiplexer for the High Speed A/D. Single-ended or differential voltages can be read at rates of up to 20,000 channels per second.	High Speed Scanner Card 69336B.
	<p>Event Sensing</p>	It is often necessary for a system to respond quickly to alarm conditions, operator intervention or other requests for immediate service. This service request is made via a program interrupt generated by either an event sense or a process interrupt card.	Event Sense, 69434A; Process Interrupt, 69436A.
	<p>Digital Input</p>	Digital input cards accept 12 bits of data from digital measuring instruments, push buttons, switches, relays, and other digital devices in the form of logic levels or contact closures. Digital data sources with more than 12 bits of data use several digital input cards.	Digital Input, 69431A; Isolated Digital Input, 69430A.

New Multiprogrammer plug-in cards are being developed. Ask your HP Field Sales Engineer for the latest technical data describing all Multiprogrammer products.

Desktop Computer-Based Multiprogrammers

Unless your automatic system requires the high-speed execution of a computer, there's a good chance you can take advantage of the economy, flexibility, and ease-of-programming offered by a desktop computer-based Multiprogrammer. The heart of the Multiprogrammer approach to real-time system design is the HP Desktop Computing Controller.

9826 BASIC and HPL desktop computer: offers a choice of two powerful languages, HP-enhanced BASIC or high-level HPL, both suitable for test and control applications. Features include a CRT display, built in mini-floppy disk drive up to 512k bytes of read-write memory, graphics capability and high speed.

9835 BASIC language desktop computer: features a powerful version of the BASIC programming language plus assembly language and up to 246K bytes of user read-write memory. The CRT display greatly simplified program entry and editing.

9845 BASIC language desktop computer: provides the same capabilities of the 9835 plus graphics. All three controllers may be interfaced with the 6940B via 16-bit duplex or HP-IB.

A basic system includes an HP desktop computing controller, a 6940B Multiprogrammer, from one to fifteen plug-in I/O cards, and the interfacing accessories of your choice. Model 6941B Extender mainframes and additional I/O cards can be used to further expand the system.

HP-IB Interfacing Accessories

For HP-IB systems, a 59500A Multiprogrammer Interface unit is required, together with the HP-IB interface card associated with your computing controller (98034A card for 9825A controllers).

Multiprogrammer Cabling Accessories

Computing controller-to-59500A interface unit: One HP-IB cable is supplied with the controller interface card. Additional 10833, B or C cables can be ordered separately in 1, 2, or 4 metre lengths.

59500A-to-6940B: Standard 18-inch (0.46 m) chaining cable Model 14541A, supplied with 59500A.

6940B-to-6941B: Standard 18-inch (0.46 m) chaining cable Model 14541A, purchased separately. Lengths up to 100 ft (30 m) are available on special order.

14558A Termination Panel facilitates field wiring to the I/O cards. Used in conjunction with the 14560A, 14561A and 14562A cables, it brings the edge connections of the I/O cards out to a 19-inch rack mounting screw terminal barrier strip.

Plug-in card-to-users device: 14555A connector provided with most Multiprogrammer plug-in cards for user to fabricate own cable.

16-Bit Duplex Interface

The Multiprogrammer may also be interfaced directly to a 9825, 9835 or 9845 computing controller using the 98032A option 040 for the 9825, or 98032A option 340. The 98032A option 040/340/440 comes with the interface card, a book, and a cable ready to connect to the 6940B mainframe. Sixteen-bit interfaces are also available for models 9826, 9825, and 9915 computers.

Documentation Package

A complete documentation package is supplied with each purchase, including a User's Guide for the selected desktop computer, a Multiprogrammer User's Guide, and Operating and Service Manuals for the various Multiprogrammer mainframes, plug-in cards, and accessories.

Minicomputer-Based Multiprogrammers

Hewlett-Packard computers are interfaced to most Multiprogrammers with HP Interface Kit 14550C. The kit contains the HP computer-to-6940B cable, verification and driver software, and plug-in cards and cable.

14550C Interface Kit for HP Minicomputers

This kit provides all the equipment necessary to install, verify, and operate a Multiprogrammer with HP 1000 series computers.

Condensed Specifications

6940B/6941B Common Specifications

Input/output card positions: Maximum of 15 plug-in input or output cards per mainframe. Hinged front panel provides access.

Mainframe data connectors: Two 50-contact, ribbon connectors.

Data transfer rate: up to 20,000 words/second.

Maximum data resolution: 12 bits per plug-in card.

Accessories furnished: Data Input Plug, PC Board Extender Card.

Cooling: Natural convection.

Temperature: 0°C to 55°C operating, -40°C to +75°C storage.

Size: 172.2 H x 425.4 W x 539.8 mm D (6.78" x 16.75" x 21.25").

Power: 100/120/220/240 VAC selectable, 48-440 Hz, 230 watts.

6940B Specifications

Front panel controls: Power ON/OFF switch and indicator lamp, REMOTE/LOCAL switch for selecting computer or manual control, 19 switches for manual data entry and control.

Weight: net, 15.9 kg (35 lb). Shipping, 19.5 kg (43 lb).

Price
\$1900

6941B Specifications

Front panel controls: Power ON/OFF switch and indicator lamp.

Weight: net, 15.2 kg (33.5 lb). Shipping, 18.3 kg (40.3 lb).

\$1700

Programmable Plug-In Cards

Output Cards

69500A-69506A Resistance Output Cards:	\$350-\$400
69510A-69513A Resistance Output Cards:	\$400
69520A Power Supply Programming Card:	\$450
69321B Voltage D/A Converter Card:	\$400
69322A Quad D/A Voltage Converter Card:	\$600
69330A Relay Output Card:	\$330
69433A Relay Output/Readback Card:	\$300
69331A Digital Output Card:	\$210
69332A Open Collector Output Card:	\$130
69335A Stepping Motor Control Card:	\$200
69380A Breadboard Output Card:	\$150
69602A Timer/Pacer Card:	\$400

Input Cards

69336B High Speed Scanner Card:	\$400
69422A High Speed A/D Converter Card:	\$700
69423A Low Level A/D Converter Card:	\$700
69431A Digital Input Card:	\$210
69430A Isolated Digital Input Card:	\$250
69434A Event Sense Card:	\$400
69435A Pulse Counter Card:	\$200
69436A Process Interrupt Card:	\$400
69480A Breadboard Input Card:	\$125

59500A Interface Unit Specifications

\$975

Converts the serial ASCII alphanumerics of the HP-IB to the 16-bit parallel format required by the 6940B/6941B Multiprogrammer. The 59500A design is optimized for ease of programming the 6940B/6941B.

Front panel controls: Power ON/OFF switch and indicator. LED's indicate mode and gate/flag status between HP-IB and the Multiprogrammer for system check-out and maintenance.

Cooling: Natural convection.

Temperature: 0°C to 55°C operating; -40°C to +75°C storage.

Size: 82.6 H x 425.4 W x 463.6 mm D (3.25" x 16.75" x 18.25").

Weight: 5.4 kg (12 lb).

Power: 100/120/220/240 VAC (selectable) 48-440 Hz, 15 W.



DATA ACQUISITION, TEST & CONTROL SYSTEMS

Multiprogrammer: Versatile Data Acquisition and Control

Model 6942A

- Action-Oriented Instructions
- Isolated Analog Inputs and Outputs
- Built-in Self Test

- Overlapped Input and Output
- Internal or External Pacing
- Easy to Configure

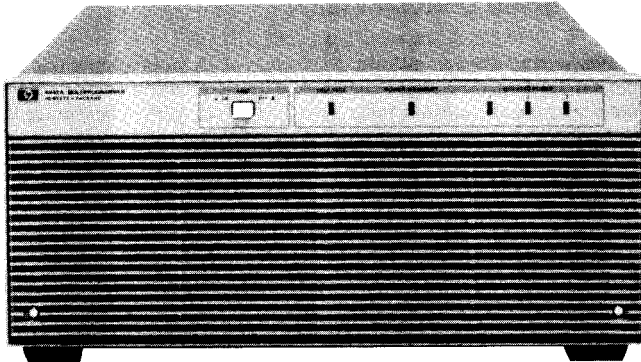

6942A



The Multiprogrammer Performs Operations in Parallel

With this one instrument you can control several processes at once. And, while you are controlling the processes, the Multiprogrammer can also be watching for interrupt conditions. The internal microprocessor manages all the parallel operations and monitors the alarm lines; when the operations have completed or if an alarm condition occurs, the Multiprogrammer interrupts the controller.

How does the 6942A Connect With Your Controller?

The 6942A Multiprogrammer interfaces with your controller (desktop or minicomputer) using the HP-IB, Hewlett-Packard's implementation of IEEE Standard 488 and the identical ANSI Standard MC1.1. Data and status readback make use of the extended bus addressing features of the HP-IB.

Documentation Package

The complete documentation package supplied with each mainframe includes a User's Guide, with programming examples for all the desktop computer controllers, a utility program tape, operating and service manuals, and a binder to hold all this material.

Programming Flexibility

Mnemonic, action-oriented instructions make the 6942A Multiprogrammer simple to learn and use. For instance, the output instruction "OP" works with all output cards. When you send an instruction, the internal microprocessor checks which type of card you are addressing and automatically converts the data to the proper format for that card. You select the units with which you want to program each card. Whether you want to use volts, millivolts, amps, degrees, feet, or any other units, the Multiprogrammer does the converting for you.

Mainframe Memory Unburdens The Controller

The mainframe memory of the 6942A will accept up to 76 instructions from the controller at one time. This leaves your controller free for other processing activities while the Multiprogrammer works on the I/O operations. This mainframe memory may also be used to collect up to 1440 data readings and hold them until the controller is free to take them. For even more data storage, 4K Memory Cards, 69790A, may be used to store 4096 16-bit words of input or output data.

Real Time Clock

Built-in real-time clock gives you time-of-day readings and pacing of measurements. The clock detects which power line frequency you are using, 50 Hz, or 60 Hz, and automatically synchronizes itself to this frequency. The range of the clock is 65,534 days, with resolution to a tenth of a second.

Accessories

14700A extender kit: This kit contains the transmission boards which go into the master mainframe (6942A) and the last extender mainframe in the chain.

14701A intermediate extender kit: When more than two mainframes are in a chain, the card in this kit must be used in each intermediate extender mainframe.

14702A chaining cable: This is the cable which chains together the master and extender mainframes. One cable is required for each extender mainframe.

14703A card edge connector: Extra connectors for the I/O cards may be ordered in addition to the one supplied with each I/O card.

Which is the Right Multiprogrammer For You?

The 6942A is the right choice when you require the easiest to program solution and can sacrifice programming speed to achieve this. While the 6942A is far from slow, it cannot match the 20,000 words per second throughput rate of the 6940B. In applications where only bursts of high speed are required, the Memory card, 69790A may be used with the 6942A to obtain high speeds (up to 33,000 words per second) for limited amounts of data (up to 4096 readings).

The 6940B offers maximum continuous throughput especially important in certain real-time control applications. For the less complex application, the 6940B also offers the lower hardware cost. Either way, there is no wrong choice when you choose a Multiprogrammer as your interface.

6942A/6943A Specifications

Plug-in I/O card positions: maximum of 16 plug-in output or input cards per mainframe. Removable rear cover provides access to card slots.

Computer interface (6942A only): the Multiprogrammer is connected to a controller via the Hewlett-Packard Interface Bus (HP-IB), Hewlett-Packard's implementation of IEEE Std. 488.

Real time clock (6942A only): the built-in real time clock is automatically synchronized with the 50/60 Hz ac power line frequency. The clock is read and set with data in the form of days, hours, minutes and seconds with a resolution of 0.1 seconds.

Extender interface kits (6943A only): each 6943A Extender requires one 14700A or 14701A Interface Kit and one 14702A Chaining Cable for operation with the 6942A.

Maximum number of mainframes per chain: up to seven 6943A Multiprogrammer Extenders may be placed in a chain with one 6942A Multiprogrammer.

Maximum chain length: a chain of mainframes can be up to 152 meters (500 feet) long. This maximum length is the sum of the lengths of all 14702A Chaining Cables used in one chain.

Power supplies: all power supplies for up to 16 I/O cards are built-in including three ± 18 V supplies isolated from each other and from the ground.

Cooling: built-in forced air cooling draws air in through the front panel and exhausts air through the ventilated rear cover.

Front panel indicators: five light emitting diodes on the front panel indicate power supply and self-test status.

Operating temperature range: 0°C to 55°C.

Power: 100/120/220/240 VAC (selectable), +5%, -10%, 47 to 63 Hz, 600 VA.

Dimensions: 177.0 mm high x 425.5 wide x 597.0 mm deep, (6.969 in. high x 16.250 in. wide x 23.500 in. deep).

Weight (without I/O cards): net, 20 kg. (45 lbs); shipping, 27 kg. (60 lbs).

Accessories furnished: PC board Extender Card (HP Part No. 5060-2792).

6942A I/O Card Functions

For a complete description of the 6942A Multiprogrammer, ask for publication 5952-4034

	Functions	Applications	Cards Used	
S T I M U L U S		Programmable DC Voltage and Current	The output voltage (up to 250V) and current (up to 1000A) of forty different HP power supplies can be programmed to provide bias in automatic test systems or control of electromechanical process equipment.	Resistance Output, 69700A-69706A.
		Digital-to-Analog Conversion	Twelve-bit voltage DAC's provide outputs for strip chart, x-y, and analog tape recorders as well as control of analog programmable instruments and stimulus of units under test. Control process equipment with 4-20mA outputs.	Voltage DAC, 69720A; Current DAC, 69721A.
		Analog Waveform Synthesis	The Memory card can continually supply pre-loaded data to the D/A card at rates of up to 100kHz. Special waveforms may be loaded into the Memory card from the computer and used as stimuli for test and processes.	Memory card, 69790B; Voltage DAC, 69720A; or Current DAC, 69721A.
M E A S U R E M E N T		Voltage, Current, and Resistance Measurements	A/D converters may be used to measure voltages from $\pm 50\mu\text{V}$ to $\pm 100\text{V}$ in the presence of 250V of common-mode noise. Connecting a resistor across the input permits current measurements for 4-20mA current loops used in process control. Combine the A/D with the current DAC for resistance measurements.	High Speed ADC, 69751A.
		Frequency Measurements	The Pulse Counter card accumulates counts over a precise time interval when a Timer card is connected to the enable line of the Counter. The program divides the count by the time interval to measure frequencies from 1 MHz to less than 0.001Hz.	Counter, 69775A; Timer, 69736A.
		Pulse Counting Preset and UP/Down	The Counter may be preset to any value within the count range of 0 to 65,535 and can cause an interrupt when it rolls over. The Counter may be enabled and disabled by pulses or levels. The computer may read the count without disturbing the counting process.	Counter, 69775A.
		Offline Analog Acquisition	Differential or single-ended signals may be digitized at rates up to 33kHz by the A/D, and stored on the Memory card. Each Memory card can store up to 4096 Readings. The digitizing process can take place independent of other Multiprogrammer activity.	High Speed ADC, 69751A; Memory card, 69790B.
		Time Interval Measurement	Elapsed time between two events can be measured in the range of $10\mu\text{s}$ to 65,000 days. The Counter card counts a known frequency over the unknown interval. This count is divided by the known frequency to determine the interval. For resolution of .1 sec, the built-in real time clock alone may be used. This real time clock provides time-of-day readings.	Counter, 69775A; Timer/Pacer, 69736A.
C O N T R O L		Digital Output and Switching	Sixteen-bits of data in TTL, open collector, or SPST relay-contact form provide digital control of instruments, indicators, and solid-state AC relays.	Digital Output, 69731A; Relay Output, 69730A
		Digital Input	Digital Input cards accept 16-bits of data from digital measuring instruments, push-buttons, switches, relays, and other digital devices in the form of logic levels or contact closures. Digital data sources with more than 16-bits of data use several digital input cards.	Digital Input, 69771A; Isolated Digital Input, 69770A.
		Stepping Motor Control	The Stepping Motor card can produce from 1 to 32767 pulses at either of two outputs (CW or CCW) to control motor translators. Output pulses are also used for pulse-train update of supervisory control stations. The pulse rate (motor speed) is also programmable.	Pulse Train/Stepping Motor, 69735A.
		Time and Frequency Reference	Crystal controlled timing pulses, programmable from $1\mu\text{s}$ to 18 hours, may be used as a time-base reference for control, measurement, and data acquisition. Period, duty cycle, and number of pulses are all programmable.	Timer, 69736A or Pulse Train 69735A.
A L A R M		Level Detecting	When signals cross preset levels, the Digital Input card can trigger the interrupt card to interrupt the computer. The alarm trigger levels can be programmed with the D/A or fixed with resistors.	Digital Input 69771A; Interrupt card, 69776A.
		Event Sensing	A digital word may be used to trigger quick computer response with the interrupt card. The computer responds to the interrupt with a software routine. The interrupt may also cause immediate local response by triggering a preloaded output card.	Interrupt card, 69776A

DATA ACQUISITION, TEST & CONTROL SYSTEMS

Multiprogrammer: Versatile Data Acquisition & Control

Model 6942A (Cont.)

6942A Applications

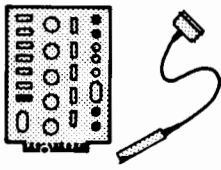
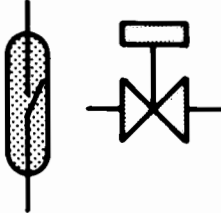
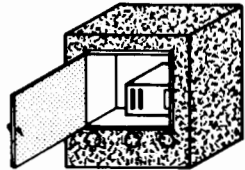
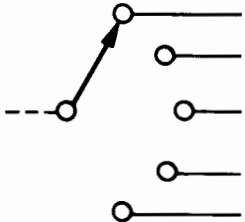
Product Testing	
<p>Electronic Subassembly Testing</p> <p>The digital and analog inputs and outputs of the Multiprogrammer are connected through fixtures to printed circuits modules, cables, and other assemblies such as D/A and A/D converters, filters, and oscillators for incoming inspection, production, calibration, and troubleshooting. During the test, 69701A Resistance Output cards control the outputs of DC Power Supplies that bias the subassembly. Adjustment of critical circuits is performed by a 69735A Stepping Motor control card that operates a motor translator and flexible shaft as an automatic screwdriver. Multiconductor cables are tested for continuity with 69731A Digital Output and 69771A Digital Input cards.</p>	
<p>Electromechanical Component Testing</p> <p>A wide variety of tests on relays and solenoids are performed with Multiprogrammers, including operational test in which the 69731A Digital Output card applies power to the coil, and 69771A Digital Input cards check for proper contact action. Hysteresis in the relay is often measured by generating a staircase function from a programmable power supply under the control of a 69701A Resistance Output card. Time delays are measured with the 69775A Counter card 69736A Timer/Pacer card. Contact and coil resistance at various current levels are measured by using a 69721A Current DAC or Constant Current DC Power Supply and the 69751A High Speed A/D card. Production tests of other electromechanical devices such as process control valves, flowmeters, tachometers, gauges, switches, and detectors are performed with Multiprogrammer-based automatic systems.</p>	
Research and Development	
<p>Environmental Testing</p> <p>Multiprogrammer I/O cards are not only capable of operating analog and digital instruments under environmental test and measuring their performance, but are also well suited to control environmental chamber parameters such as temperature, pressure and humidity during the test cycle. In other types of environmental testing such as operation of shake tables for small structures, and control of hydraulic rams for large structures and vehicles, 69720A Voltage DAC cards are programmed to synthesize the waveforms that simulate actual transportation and shock conditions. Designers can alter parameters during the lab test to analyze the effect of severe stresses and abusive treatment.</p>	
Monitoring and Control	
<p>Data Acquisition and Signal Distribution</p> <p>Data acquisition systems employ the 69751A High Speed ADC card for measurement and the 69790A Memory card for storage of up to 4096 of the measurements. Digital signals may be stored directly on the 69790B Memory card or the 69771A Digital Input card may be used when local storage is not required. Optical isolators on the 69770A Isolated Digital Input card may be used for monitoring 115 or 230 V ac signals. Control signals up to 100 V dc or ac rms are distributed directly to the process with 69730A Relay Output cards, while the 69731A Digital Output cards control solid-state ac or dc relays for controlling voltages above 100 volts. The Multiprogrammer mainframe can be separated by up to 500 feet (150 meters), so that proper location of mainframes used for scanning and distribution significantly reduce cabling costs to sensors and indicators.</p>	

Ordering Information

6942A Multiprogrammer	\$3900
Option 910 Extra Manual	\$30
Option 908 Rack Mount Kit	\$30
6943A Multiprogrammer Extender	\$3000
Option 908 Rack Mount Kit	\$30
10833A HP-IB Cable, 1m (3.3 ft)	\$70
10833B HP-IB Cable, 2m (6.6 ft.)	\$75
10833C HP-IB Cable, 4m (13.2 ft)	\$85
10833D HP-IB Cable, 0.5m (1.6 ft)	\$70
14700A Extender Kit	\$450
14701A Intermediate Extender Kit	\$300
14702A Chaining Cable	\$250
14703A Card Edge Connector	\$40

Price

Programmable Plug-In Cards

69700A-69706A Resistance Output cards	\$600
69720A D/A Voltage Converter card	\$700
69721A D/A Current Converter card	\$900
69730A Relay Output card	\$550
69731A Digital Output card	\$400
69735A Pulse Train output/Stepping Motor Control card	\$500
69736A Timer/Pacer card	\$500
69751A A/D Converter card	\$950
69770A Isolated Digital Input Card	\$650
69771A Digital Input/Analog comparator card	\$600
69775A Counter/Totalizer card	\$725
69776A Interrupt card	\$550
69790B Memory card	\$1500
69793A Breadboard card	\$150

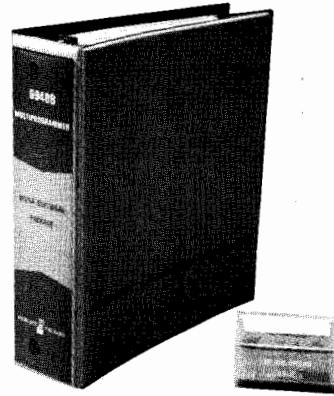
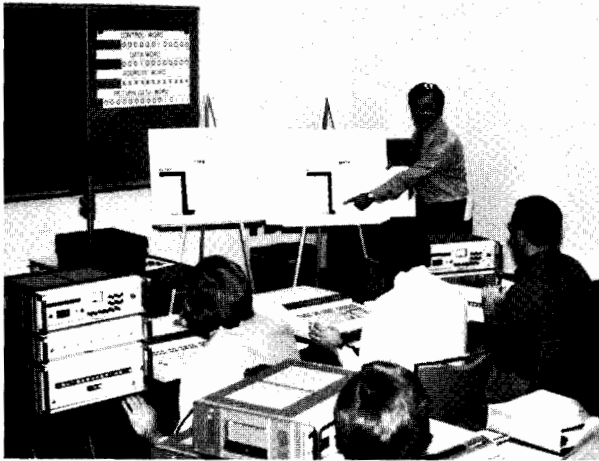

Multiprogrammer Training Course

The fastest way to learn to use the 6940B or 6942A Multiprogrammer is to enroll in the Multiprogrammer Training Course, given at various sites around the country. At the Multiprogrammer School you will receive three days of in-depth training from Multiprogrammer experts. The school also gives you the chance to ask the experts questions regarding your particular application. The school offers a hand-on approach to get you programming the multiprogrammer fast.

Software Library

The 14556A Software Library offers 9825 users a simplified way to operate the Multiprogrammer. Simply select from the 40 high level routines, those which you would like to use. The Autoloader will load these from the Library tape and append them to your program ready for your use.

To read analog voltages, the program will look like this:

```
0: c11'Analog Input" [5,X]
1: prt X
2: end
```

The voltage from the A/D Card in slot 5 of the Multiprogrammer is printed as a decimal value.

The Library tape contains routines for both HP-IB and 16-bit duplex systems. It comes complete with an easy-to-use manual with step by step instructions on the tape's use.

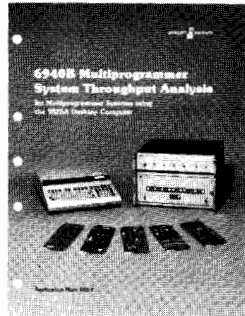
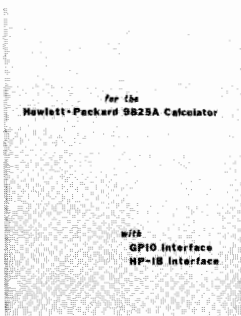

User's Guide

User's Guides are provided with the 6940B and 6942A to help you get started on your own. Examples are given showing how to use each Multiprogrammer plug-in card. Chapters are included dealing with high speed input and output as well as number theory and subprogram writing.

Throughput Analysis

To find out how much time is required for all various 6940B Multiprogrammer operations with a 9825A computer, ask your HP Field Engineer for a copy of AN 282-1, "System Throughput Analysis". This application note will tell you what throughput rates you will encounter, whether you are using HP-IB or 16-bit duplex. Also included in AN 282-1 are the throughput rates when using the 14556A Software Library.

This information is similar to the timing analysis of the 6942A included in the 6942A data sheet.



Service Kit

The HP Model 14551A Multiprogrammer Service Kit is a diagnostic and service aid for the Hewlett-Packard Model 6940A/B Multiprogrammer subsystems. It is used by users with a need for the shortest possible down time.

Like the Multiprogrammer itself, the standard kit is flexible and can be specifically configured to meet each user's needs. The 14551A contains a selection of the most frequently needed replacement assemblies and spare parts, and documentation for trouble isolation. It allows Multiprogrammer users to make most repairs on-site, with resulting minimum down time.

The 14551A is designed to be used with an HP computer in the HP 1000 series, a 9825A desktop computer, or by the 6940B operating alone in the LOCAL mode.



DATA ACQUISITION, TEST & CONTROL SYSTEMS

Measurement and Control Processor

HP 2250M, HP 2250N, HP 2250R

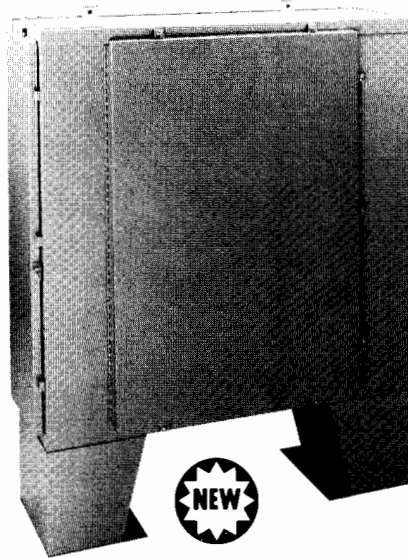
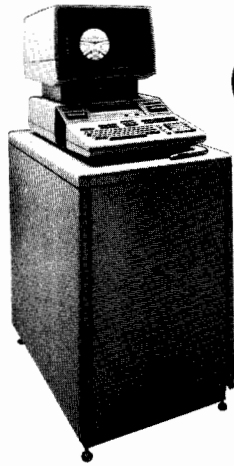

HP 2250M Measurement & Control Processor (shown with HP 9845 Desktop Computer)

HP 2250N Measurement & Control Processor (Enclosed in NEMA-12 cabinet)

HP 2250R Measurement & Control Processor (shown with HP 1000 Computer System)

Function/Applications

The HP 2250 Measurement and Control Processor is the nucleus of a new family of HP automation systems that provide powerful capabilities for laboratory and industrial automation applications. The HP 2250's modular hardware structure gives you the versatility of selecting only the product you need for a cost-effective solution to your specific automation problem—yet you have the flexibility to expand your capabilities as your automation needs grow.

The HP 2250 operates in conjunction with a HP 1000 or HP 9800 series computer via the HP-IB, Hewlett-Packard Interface Bus, our implementation of IEEE Standard 488-1978 and identical ANSI Standard MC1.1. A single HP-IB cable connection is all that is required to link your computer to the HP 2250, creating a high-performance automation system. For those applications that require the 2250 to be remotely located, a coaxial cable or fiber optic HP-IB extender is available to extend the computer/2250 link up to 1000 metres.

The HP 2250 has a built-in LSI microcomputer and MCL/50 firmware, a software command set comprised of over 100 applications oriented mnemonic commands that can be used in many combinations to optimize measurement and control operations. MCL/50 Measurement and Control language software is easy to learn and use, allowing a user who is not a computer scientist to program his applications and control all 2250 function cards without tying up or intervention from the host computer. This decoupled operation facilitates a simpler and faster implementation of your automation solution, and results in more predictable and repeatable performance.

Measurement and control application exist in many different environments—and the modular HP 2250 hardware is designed with the flexibility to meet the diverse requirements of these applications. A comprehensive set of high performance analog and digital function cards are available to interface to the broad range of sensors and actu-

ators commonly found in laboratory and industrial environments today. Additionally, most function cards include provisions for on-board signal conditioning modules that permit accurate and reliable interfacing in demanding industrial applications. The appropriate function cards selected for your applications are installed into one of three available HP 2250 Measurement and Control Processor packages. Convenient industrialized field wiring assemblies accommodating up to 10 AWG wire are available for these packages.

- **HP 2250M**—an M&C processor packaged in a mobile 36-inch high cabinet that interfaces up to 240 analog/digital points. Combined with any HP 9800 series desktop computer or small HP 1000 computer, this configuration is ideal for laboratory experiments and small light manufacturing applications.
- **HP 2250N**—an M&C processor packaged in a NEMA-12 steel enclosure that interfaces up to 480 analog/digital points. This rugged industrial cabinet is suitable for harsh manufacturing or outdoor environments and is sealed against dirt, oil, water. This configuration is designed for use with the HP 1000 L-Series computer and can either be remoted from the computer over the HP-IB optic cable or made part of a distributed plant network by plugging in the HP 1000L microcomputer.
- **HP 2250R**—in this configuration, the M&C processor is installed in a 56-inch high two bay cabinet that interfaces up to 480 analog/digital points. Up to two additional 56 inch cabinets can be added to extend the total interface capability up to 2032 analog/digital points. The HP 2250R can be used with all HP 1000 series computers as a high-performance automation system. Typical applications are large laboratory facilities, complex electromechanical product test or supervisory control systems.

In addition to the configured M&C processor packages above, the HP 2250 products are available in panel and rack mount versions for installation in your own cabinets.



Specifications

Performance Specifications

Analog Inputs	A/D Converter	High Level MUX	Low Level MUX	Relay MUX
Number of Differential Channels	16	32	32	16
Input Signals	High-level voltages or current loop sensing from transmitters, sensors or equipment			
Voltage Range	Thermocouples or other millivolt sensors			
	min. $\pm 1.25V \pm 10V$	$\pm 1.25V \pm 10V$	$\pm 12.5mV \pm 10V$	$\pm 12.5mV \pm 100V$
Conversion Rate on Channel (samples/sec)	50,000	50,000	50,000	10,000
Scanning Rate (samples/sec)	50,000	50,000	20,000	1,000
Max. Common Mode Voltage*	$\pm 10V$	$\pm 10V$	$\pm 10V$	$\pm 300V$

*signal + cmv

Analog Output: 12 bits. $\pm 10V$ or 0–20 mA, all 4 channels isolated from each other and ground.

Digital Inputs	Digital Input	Multi-function	Counter
Number of Channels	32	16	4 A/B pairs
Input Signals	Switches, actuator monitoring, logic levels.		
	Tachometers, flowmeters		
Event Scale Prescale Range	1	to 256	to 32767
Totalize Range	N/A	to 256	to 2×10^6 or 32767
Frequency	N/A	N/A	to 500 kHz
Period	N/A	N/A	0.2 μ sec to 50 min
Input Ranges with removable contact debounce filter	Isolated 5-120 Vdc or 16-230 Vac Non-isolated 5-12 Vdc contact sense.		

Digital Outputs	Digital Output	Multi-function	Relay Output	Pulse Output
Number of Channels	32 dc 16 ac	16 dc 8 ac	16 NO/NC pairs	4 A/B pairs 8 limits in
Control of Devices	Valves, solenoids, logic levels			
	Lamps, displays			Stepper motors, setpoints
Output Ranges	to 60 Vdc or 42 Vac with optional pullup and isolation or 120 VAC isolated	to 230 Vac or 30 Vdc with arc suppression		60 VDC with pullup and isolation

HP-IB Input/Output Rate: 500 Kbytes/sec

Operating Specifications

Operating temperature range: 0 to 50°C (HP 2250N), 0° to 40°C (HP2250M/R)

Storage temperature range: -40°C to +75°C

Relative humidity: 10% to 95% non-condensing @ 40°C

Physical Specifications

Size: HP 2250M: 927.1mm H x 737mm W x 813mm D (36.5 x 29 x 32")

HP 2250N: 1829mm H x 1219mm W x 508mm D (72 x 48 x 20")

HP 2250R: 1622mm H x 533mm W x 762mm D (64.3 x 21 x 30")

HP 2251AN: M&C Unit: 540mm H x 367mm D x 394mm (21.25 x 14.5 x 15.5")

Net weight: HP 2250M: 87.54k, (193 lbs)

HP 2250N: 204.12kg (405 lbs)

HP 2250R: 154.22kg (340 lbs)

HP 2251AN M & C Unit: 34kg (15 lbs)

HP 2104AN Processor Unit: 37kg (17 lbs)

Special Features

- High-performance analog measurement capability includes
 - 14-bit resolution and 17-bit dynamic range
 - 0.08% accuracy from 0 to 50°C
 - 50,000 samples per second average throughput to disc
 - 45,000 samples per sec paced throughput to disc
 - 350 Volt common mode protection
 - isolated voltage and current outputs
- Wide range of function cards are available, with 42 separate, plug-on signal conditioning modules.
- HP MCL/50 high level command set enables real-time task delegation and decoupled controller operation.
- Solid state output relay digital design is ruggedized to enable mechanical relay replacement.
- All I/O points can be floated or isolated.
- Rack and panel mount hardware is available.

Installation Requirements/Factors

Power Requirements

Voltage: 115/230 VAC, +10%, -25%, single-phase, 47 to 66 Hz

Current: 7A max @ 115 Vac, 3A max. @ 230 Vac

Power: 525 watts max.

Ordering Information and Related Products

- | | Price |
|---|-----------------|
| • HP 2250M Mobile Measurement and Control Processor | \$10,000 |
| • HP 2250N NEMA-Mounted Measurement and Control Processor | \$12,000 |
| • HP 2250R Rack-Mounted Measurement and Control Processor | \$12,000 |
| • HP 2251AN/AR Measurement and Control Unit | \$2,000 |
| • HP 2104AN/AR Processor Unit | \$7,000 |
| • HP 25501A 16-Channel High Speed Analog Input Card | \$2,500 |
| • HP 25502A 32-Channel High Level Multiplexer Card | \$1,250 |
| • HP 25503A 32-Channel Low Level Multiplexer Card | \$2,000 |
| • HP 25504A 16-Channel Relay Multiplexer Card | \$1,650 |
| • HP 25510A 4-Channel Isolated Voltage/Current Analog Output Card | \$1,340 |
| • HP 25511A 32-Channel Digital Input Card | \$570 |
| • HP 25512A 4-Channel Counter Card | To be announced |
| • HP 25513A 32-Channel Digital Output Card | \$550 |
| • HP 25514A 16-Channel Relay Output Card | \$780 |
| • HP 25515A 4-Channel Pulse Generator Card | To be announced |
| • HP 25516A 16-Point In/16-Point Out Digital Multi-function Card | \$800 |
| • HP 25594A Thermocouple Reference Connector | \$410 |
| • HP 25531/ 25535B, C, D, E, K, L 1-Point/4-Point Non-Isolated Digital Input Signal Conditioning Modules | \$20 |
| • HP 25533B, C, D, E, F, G, H, J/HP25537P, Q, R, S, T, U, V, W 1-Point/4-Point Isolated Digital Input Signal Conditioning Modules | \$25 |
| • HP 25539A, E, G, H, J 4-Point Relay Arc Suppression Signal Conditioning Modules | \$20 to \$150 |
| • HP 25540A, B, C, D 8-Channel Analog Input Signal Conditioning Modules | \$15 to \$170 |
| • HP 25543N 4-Channel Isolated Output Signal Conditioning Module | \$65 |
| • HP 25544A, B, C 4-Channel Non-Isolated Output Signal Conditioning Modules | \$65 |
| • HP 25545P 2-Channel Solid State Relay AC Output Signal Conditioning Modules | \$65 |

The HP 2250 Measurement and Control Processor may be used with the following HP computing controllers:

- HP 1000 Computers and Systems, all series
- HP 9800 Series Desktop Computers

For more information on the HP 2250 Measurement and Control Processor, I/O function cards, signal conditioning modules and accessories, contact your local HP Sales Representative, see page 749.

DATA ACQUISITION, TEST & CONTROL SYSTEMS

Measurement and Control Computer Interface

Model 2240A and System 9030

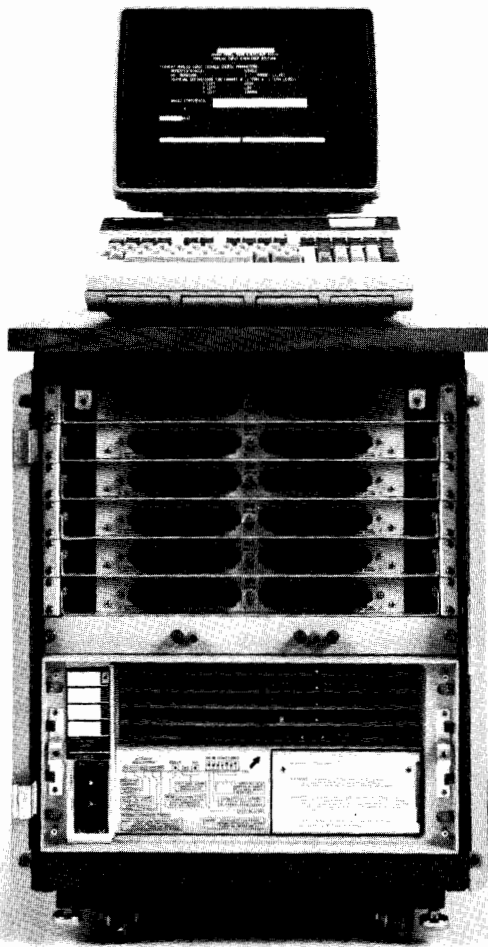

System 9030

System 9030

The HP 2240 can be installed in a roll-around cabinet with plug connectors for portable use. Adding a controller (HP 9825, 9835, or 9845) and available exercising software, the preconfigured combination is called the HP System 9030. Contact your local HP office for information about specific ordering constraints.

2240/2241A Measurement and Control Processor

The microprocessor-based HP 2240A Measurement and Control Processor provides 128 channels of both analog and digital input/output signals, with interrupt handling for complete measurement and control capability in one unit. The HP 2241A Extender adds up to 128 channels to extend the capability to a total of 256 I/O points. The 2240A executes computer-independent, real-time tasks delegated from the controller. A powerful command set, tailored for measurement and control applications, is built into the 2240A to simplify and reduce programming. Programming can be done in BASIC, FORTRAN, HP Assembly or HPL languages via the HP-IB.

The 2240A can be used with a HP 9825, 9830A, or 9845A Desktop Computer or with the HP 1000 Computer System. Multiple 2240A test stands can be added via the HP-IB as part of a distributed measurement and control network. You can remote the 2240A up to 1000 meters over a single twisted pair of wires, or delegate tasks over phone lines with the HP 59403A HP-IB/Common Carrier Interface and industry standard modems.

The 2240A option 001, Extended Throughput ROM, increases the speed of continuous data acquisition severalfold by providing additional commands, larger buffer size, and binary data transmission instead of ASCII data transmission.

A variety of measurement and control function cards is available for the 2240A/2241A:

- **22900A Analog Input Card** \$1,840
32 single-ended or 16 differential channels, ± 10 V, 12 bits including sign, 20 kHz sample/scan rate. Auto correction for gain and offset temperature drift.
- **22901A Analog Output Card** \$1,050
4 channels, 0 to 10 V or -10 V to $+10$ V output, 10 bits with dual level storage. Auto readback from first level, 4-lead remote sense (Kelvin) connections.
- **22901B Analog Output Card** \$1,385
4 channels, 4 to 20 mA current output, 0 to 10 V, or -10 V to $+10$ V output, 12 bits resolution with dual level storage. Four-lead remote sense (Kelvin) connections.
- **22902A Digital Input Card** \$370
32 channels, TTL or CMOS levels.
- **22903A Common Interrupt Card** \$515
16 channels, TTL or CMOS levels, individual channel enable and transition direction, interrupt test.
- **22904A Digital Output Card** \$580
32 channels, TTL or CMOS, open-collector output, dual level storage, auto readback, level or pulse outputs.
- **22905A Counter/Stepper Motor Card** \$945
4 channels for event counting, frequency or period measurement, or stepper drive output. Internal self-test clock, TTL compatible.

Signal Conditioning Cards

The Signal Conditioning cards provide maximum isolation for the 2240A Measurement and Control Processor from high voltage inputs and electrical noise. Signal conditioning cards have provision for field wiring (14-22 AWG) connection to 56 screw terminal connectors. Signal conditioning cards available for the 2240 are:

- **22912C Relay Output Card** \$685
16 channels, 2 amperes, 125 VAC/DC, 60 VA rating, Form-C (SPDT) hermetically sealed relays.
- **22913C Isolated Digital Input Card** \$805
16 channels, 5 to 120 VDC and 16 to 230 VAC with selectable response times and overload fuses.
- **22914A General Purpose Breadboard Card** \$135
16 channels for analog/digital, input/output signal conditioning. Pad layouts for user-installed signal conditioning components such as amplifiers, relays, filters, fuses, resistors and voltage regulators.
- **22915C Low Level Analog Input Card** \$1,640
16 differential channels, amplifier-per-channel, jumper selectable gains ± 20 mV, ± 50 mV, ± 100 mV, ± 500 mV, ± 10 V. Pads for filters, current loop and open thermocouple detection resistors.

Ordering Information

	Price
2240A Measurement and Control Processor	\$3,150
2240A-001 Extended Throughput ROM	\$265
2240A Opt 501 Cabinets & Assembly	\$3,465
09835-10200 9835/9845 Software	\$500
09825-10200 9825 Software	\$500
2241A Extender	\$1,735

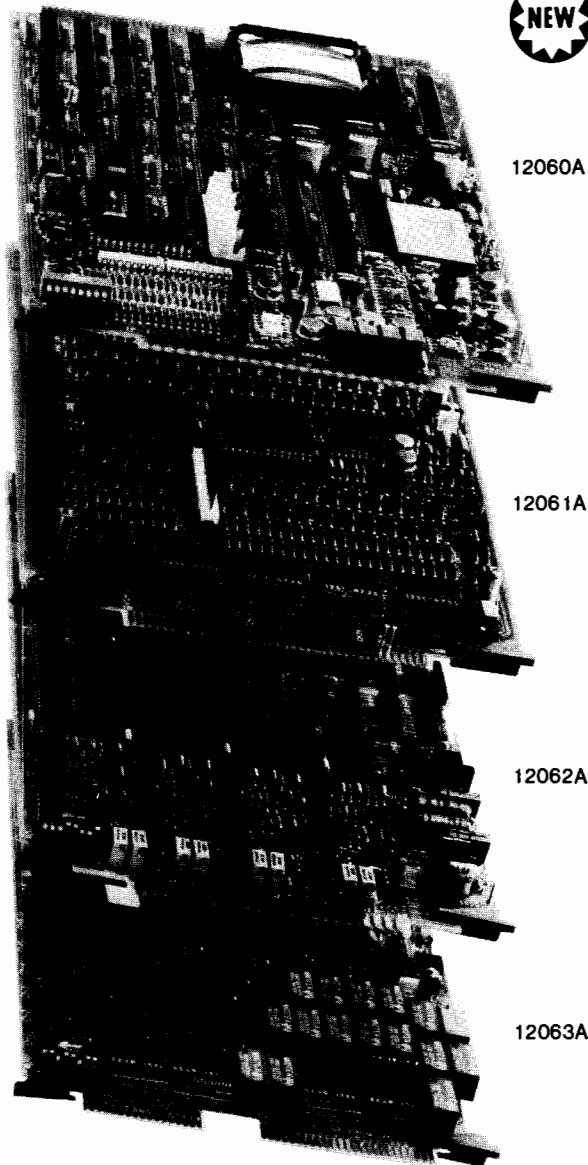

12060A

12061A

12062A

12063A

Description

The 12060A, 12061A, 12062A, and 12063A are plug-in cards for HP 1000 L-Series Computers. They provide low cost, high performance, analog and digital I/O for use in distributed measurement and control applications. The L-series product in which these cards are used must have a 25 kHz power supply. Hood connectors with each card allow the user to build cables for connection to his application.

12060A 8 Channel Analog Digital Converter Card

The 12060A is capable of acquiring up to 55,000 readings per second with 12-bit resolution. Auto scanning or single-channel sampling is possible to 55 kHz. Provisions for external pacing/trigging of sampling and scanning is provided. The 12060A includes four programmable full scale ranges from plus or minus 1.28 V to plus or minus 10.24 V. Maximum resolution is 0.625 mV on the 10.24 V range. A separate "zero reference" on the card allows the user to measure actual offset due to temperature drift, and correct readings on all channels for higher accuracy.

12061A 32 Channel Analog Input Expansion Card

The 12061A provides 32 additional differential inputs for the 12060A card. The 12061A card fastens directly onto the 12060A card, creating a two-board unit that occupies two I/O slots in an HP 1000 L-series computer. Programming information is passed from the 12060A directly to the 12061A; analog signals on the additional 32 channels are in turn passed back to the 12060A for digitizing. The 12061A includes removable plug-in headers so the user can add current sense resistors for current loop measurements. These headers allow the board to be adapted to the specific application without soldering components directly on the board and are easily removable for repair purposes.

12062A 4 Channel Analog Output Card

The 12062A Analog Output Card provides 4 independent bipolar voltage outputs. Remote sensing per channel provides accurate output voltages to compensate for long distances of field wiring. Undedicated digital outputs may be used in pen up/down control, CRT display, or X-Y plotters. DMA compatibility provides fast analog updates on a per channel basis or between channels. Programmable time delay between DMA updates provides signal reconstruction capability with a full power bandwidth of 20 kHz.

12063A 32 Channel Digital Multifunction Card

Input Characteristics

The 12063A provides 16 fully isolated digital inputs via voltage threshold opto-couplers. Input voltage levels are selectable by the user for each channel by installing the appropriately valued resistors on removable plug-in headers (8 resistors per header = 8 channels). These headers allow the board to be adapted to the specific application without soldering components directly on the board, and are easily removed for repair purposes. Plug-in opto-couplers (supplied) allow user selection of ac or dc coupling for each channel by merely installing the opto-coupler in the ac position or dc position. For ac coupling, a plug-on jumper is provided for each channel to select 60 Hz ac filtering of the rectified input if desired.

Event Detection

In addition to status, any input may be user programmed to function as an interrupt to be generated on the rising edge or falling edge of the input or both (whichever occurs first). This capability is easily activated by the user via loading the appropriate pattern into the three registers. The on-card microprocessor takes over to cause the interrupt to be generated when that event occurs. User programming is required to service the interrupt.

Debounce Delay

The same microprocessor also provides the user programmable debounce delay up to 246 msec on any input when monitoring contact closures, and may be used in both status mode and event sense mode.

Output Characteristics

Sixteen form C (SPDT) relay outputs are provided on the same card. Both the normally open (NO) and normally closed (NC) contacts are available to users. Two removable headers allow for arc suppression devices to be added by the user for *each channel* without soldering directly to the board. Each header handles 8 output channels. Plug-on jumpers select the arc suppression across the NO or NC contacts. An on-card isolated power supply derived from the 25 kHz ac supply in the L-Series processor provides coil power for the relays. This technique minimizes any coupling of relay contact noise in the computer itself. For ease of servicing, plug-in relays are used.

Ordering Information

Ordering Information	Price
12060A 8 Channel Analog/Digital Converter	\$1850.00
12061A 32 Channel Analog Input Expansion	950.00
12062A 4 Channel Digital/Analog Converter	1800.00
12063A 32 Channel Digital Multifunction Card	1800.00

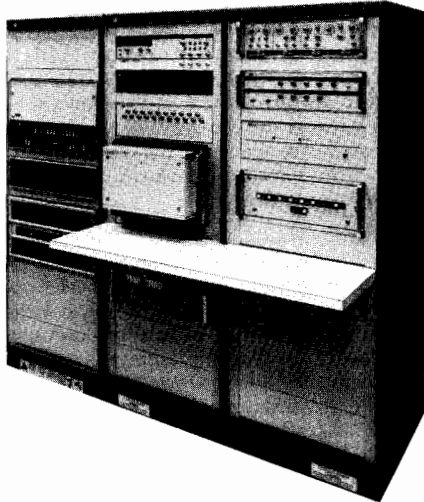

**Customized automatic test systems,
integrated by Hewlett-Packard**

ATS/1000 Integration Services

Previously, when building an automatic test system, users had only two choices: purchase an already-assembled "turn-key" system or purchase computer and instruments separately and assemble them on your own. As a result of our experience with more than 1000 HP automatic test system installations worldwide, HP offers two categories of system-building assistance, called ATS/1000 Integration Services.

An automatic test system can be purchased at various levels of completion, depending on how much help the user desires. At the lowest level, Racking and Cabling Service, HP consolidates the equipment, designs cabinet layout and power distribution, then installs the equipment in cabinets. The user assumes responsibility for software configuration and testing.

With the highest level of service, Configuration/System Test, the user receives a fully-installed, fully-integrated system, ready to solve problems. HP consolidates the equipment, installs it in cabinets, configures the operating software, and checks out the system on-site.

Integration service prices vary depending on the complexity and size of the system. A typical system that contains \$100,000 of instrumentation would require \$30,000 to \$40,000 of integration services to be fully configured and tested.

Ordering Information

93283A ATS Racking and Cabling Service
93284A ATS Configuration/System Test Service

Switches for Automatic Test

HP-IB switch products used in HP automatic test systems are available individually for HP 1000 system users who manufacture their systems in-house or those who have complex switching requirements in their HP 1000-based automated test setups. These switches provide a commercially-available solution to connecting the system to the unit-under-test (UUT). Three types of switching units are available, all controlled by a single 9411A Switch Controller that provides micro-processor control of multiple switch mainframes.

- **9411A Switch Controller** \$4,200
The 9411A is for use on HP 1000 Computer Systems and is controlled via the HP-IB. It provides control logic and relay power for the switch mainframes. Performs comprehensive self-test and fault isolation of all signal relays in the 9412A and 9414A switching units.
- **9412A Modular Switch** \$10,000
to \$35,000
Provides high-density, multi-function switching of signals up to 10 MHz. A built-in 1768-pin (34 x 52) matrix interface panel improves signal performance and eliminates "spider web" cabling. The 9412A accommodates five types of switchcards in any combination up to a total of 25 cards.
- **9413A VHF Switch** \$2800
to \$7000
Provides modular, flexible high-frequency switching of pulse and video signals up to 500 MHz. The 9413A accommodates up to 12 coaxial switch modules.
- **9414A Matrix Switch** \$7000
to \$35,000
Provides maximum flexibility in switching signals up to 10 MHz. Designed for high-density, high-performance switching, the 9414A allows any UUT pin to be switched to any instrument in the system. The 16-input matrix can be configured in 30-pin increments (UUT pins) up to 120 pins. A distribution bus allows several instruments to share four of the 16 matrix inputs, thus minimizing switching requirements.

HP 9411A
Switch
Controller

HP 9413A
VHF
Switch

HP 9412A
Modular
Switch

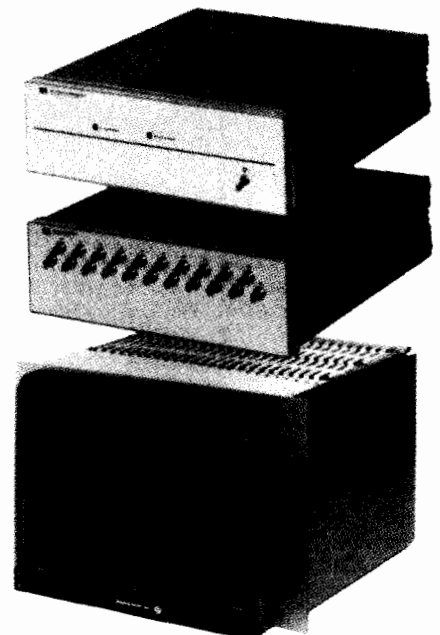

- Wide band
- Flat response
- Low noise

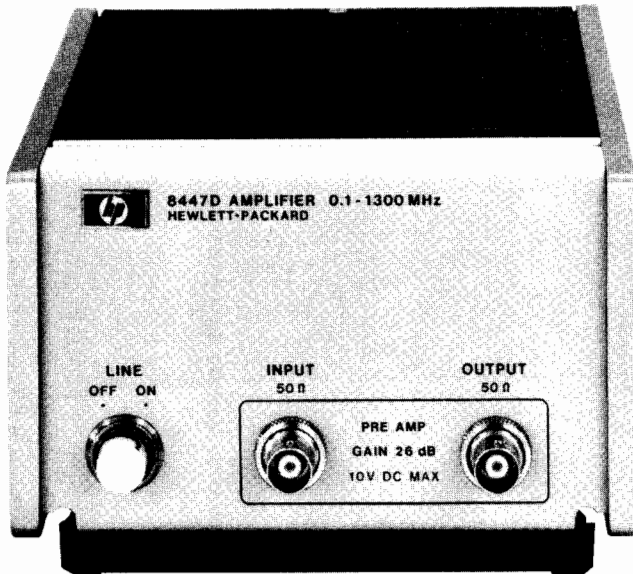

8447D

The HP 8447 series of general purpose amplifiers combines high reliability and convenience.

High Performance

The performance of these amplifiers qualifies them for a number of uses: to improve the sensitivity of counters, spectrum analyzers, RF voltmeters, EMI meters, power meters and other devices without distortion or degradation of amplitude accuracy; to increase the maximum power available from a signal generator or sweeper.

Specifications

	8447A Preamp	8447C Power Amp	8447D Preamp	8447E Power Amp	8447F Preamp-Power Amp
Frequency Range	0.1-400 MHz	30-300 MHz	100 kHz-1.3 GHz	100 kHz-1.3 GHz	100 kHz-1.3 GHz
Typical 3 dB Bandwidth	50 kHz-700 MHz	10-400 MHz	50 kHz-1.4 GHz	50 kHz-1.4 GHz	50 kHz-1.4 GHz
Gain (Mean)	20 dB ± 0.5 dB at 10 MHz	30 dB ± 1 dB	26 dB ± 1.5 dB (20°C-30°C)	22 dB ± 1.5 dB (20°C-30°C)	
Gain Flatness Across Full Frequency Range	±0.5 dB	±1 dB	±1.5 dB	±1.5 dB	
Noise Figure	<5 dB	<11 dB	<8.5 dB	<11 dB typical	
Output Power for 1 dB Gain Compression	>+6 dBm	>+17 dBm	>+7 dBm typical	>+15 dBm	
Harmonic Distortion	-32 dB for 0 dBm output	-35 dB for +10 dBm output	-30 dB for 0 dBm output (typical)	-30 dB for +10 dBm output	
Typical Output for <-60 dB Harmonic Distortion	-25 dBm	-15 dBm	-30 dBm	-20 dBm	
VSWR	<1.7	<2.0	<2.0 input <2.2 output 1-1300 MHz	<2.2 1-1300 MHz	
Impedance	50Ω	50Ω	50Ω	50Ω	
Reverse Isolation	>30 dB	>35 dB	>40 dB	>40 dB	
Maximum DC Voltage Input	±10 V	±10 V	±10 V	±10 V	
Options Available	001	002	001, 010, 011	010	010
Option Prices	add \$600	add \$30	add \$650, \$100, \$850	add \$100	add \$325

— 8447D AND 8447E COMBINED IN A SINGLE PACKAGE —

Broadband Frequency Coverage

The 8447 series offers an amplifier for nearly every application in the 100 kHz to 1.3 GHz frequency range. The wide bandwidths are compatible with other wideband instruments and accommodate wide-band spectra.

Options

A variety of options are available: a 75Ω impedance model (Option 002) for applications such as television/FM broadcasting and CATV; Option 001 and Option 011 dual channel versions with BNC and Type N connectors respectively for operation with dual channel systems such as oscilloscopes or network analyzers (or the channels may be cascaded for increased gain); Type N connectors rather than the standard BNC connectors (Option 010).

General

Weight: net, 1.56 kg (3.4 lb). Shipping, 2.30 kg (5.1 lb).

Size: 85.8 H x 130 W x 216 mm D (3.4" x 5.1" x 8.5").

Power requirements: 110 or 230 V ac ± 10%, 48-440 Hz, 15 watts.

Ordering Information

	Price
8447A Preamp	\$975
8447C Power Amp	\$1200
8447D Preamp	\$1000
8447E Power Amp	\$1100
8447F Preamp-Power Amp	\$1675

AMPLIFIERS

Microwave Power Amplifiers

Models 489A, 491C, 493A & 495A

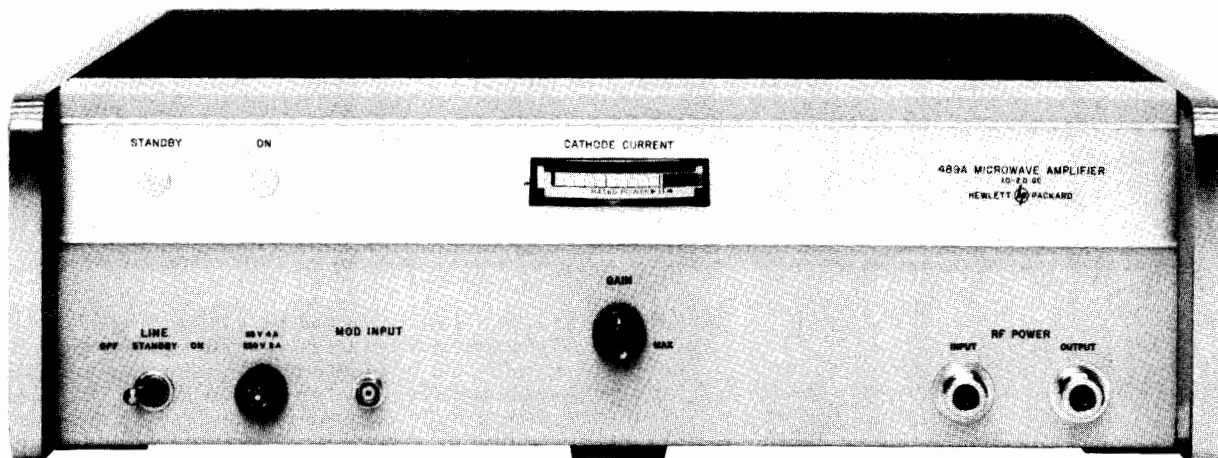

489A

Microwave TWT Amplifiers

Amplification of frequencies from 1 to 12.4 GHz is accomplished in four ranges by the Hewlett-Packard medium-power, microwave amplifiers. Each delivers at least 1 watt for a 1-milliwatt input—a gain of at least 30 dB.

All four TWT amplifiers have provision for amplitude modulation, and since the internal modulation amplifier is dc-coupled, remote programming and power leveling are possible. Sensitivity is high for large output power changes from relatively small modulation signals, obviating the need for an external modulation amplifier.

The dc amplifier has a gain of 20 dB and exhibits a passband from dc to 500 kHz when the modulation index is in the neighborhood of 1 dB, as might be encountered in RF leveling. When the modulating levels are high, in the region of 20 volts, the passband will be a minimum of 100 kHz; a 20-volt change at the MOD INPUT produces a minimum of 20 dB on/off ratio.

Cathode current in the TWT is monitored by a front panel meter and can be conveniently controlled by the GAIN adjustment for rated power output, or for reducing tube current to extend tube life when full output power is not required. The helix, collector, and anode current can be measured at an easily accessible test point board. Combined with the 8350, 8620 or 8690 Sweep Oscillator they make an excellent high power swept source.

Advantages

DC coupled modulation circuitry allows power leveling and remote programming.

Periodic-permanent-magnet focusing means fewer alignment problems.

Applications

Antenna efficiency and pattern measurements.
Extends attenuation measuring systems capability by at least 30 dB.
RFI susceptibility tests.

489A-495A Specifications

Output power: 1 watt for an input of ≤ 1 mW.

Gain: 30 dB at rated output.

Input/output: impedance, 50 Ω ; connectors, type N female.

Noise figure: ≤ 30 dB.

Amplitude modulation:

Sensitivity: modulation input of > -20 V peak reduces RF output by ≤ 20 dB from dc to 50 kHz.

Frequency response: dc to 500 kHz (3 dB).

Pulse response: < 1 μ s rise and fall times.

Size: 140 H \times 426 W \times 467 mm, (5.5" \times 16.75" \times 18.38").

Weight: net, 14.9 kg (33 lb). Shipping, 18.0 kg (40 lb).

	489A	491C	493A	495A
Frequency range (GHz)	1-2	2-4	4-8	7-12.4
Gain variation with freq. at rated output:	≤ 6 dB	≤ 6 dB	≤ 6 dB	≤ 6 dB
small signal: across any 10% of band	≤ 5 dB	≤ 5 dB	≤ 5 dB	≤ 5 dB
across full band	≤ 10 dB	≤ 10 dB	≤ 10 dB	≤ 10 dB for 300 MHz

Ordering Information

489A 1 to 2 GHz TWT Amplifier

491C 2 to 4 GHz TWT Amplifier

493A 4 to 8 GHz TWT Amplifier

495A 7 to 12.4 GHz TWT Amplifier

Opt 908: Rack Flange Kit (for all models)

Price

\$6300

\$6300

\$6600

\$6600

add \$22



Analog Voltmeter Considerations

Accuracy—Before we can discuss meter accuracy, we must have a familiarity with the various meter scales available. Many instruments have meter scales marked in both volts and decibel (dB) units. It should be noted that dB and voltage are complements of each other. That is, if a voltage scale is made linear, the dB scale on the same meter face will be logarithmic or nonlinear. Likewise, if the dB scale is made linear, the voltage scale becomes nonlinear. The term “linear-log scale” is applied to an instrument that has a linear dB scale and, therefore, a nonlinear voltage scale. Several different types of meter faces are illustrated in Figure 1.

Analog meters usually have nonlinearities and/or offsets present in the attenuators and amplifiers. The meter movement itself can have nonlinearities even with individually calibrated meter scales. Nonlinearities cause percent of reading errors, and offsets cause percent of full scale errors.

Looking at instrument specification sheets, accuracy specifications are usually expressed in one of three ways: 1. percent of the full-scale value, 2. percent of the reading, 3. (percent of reading + percent of full-scale). The first is probably the most commonly used accuracy specification. The second (percent of reading) is more commonly applied to meters having a logarithmic scale. The last method has been used more recently to obtain a tighter accuracy specification on a linear-scale instrument.

Hewlett-Packard uses the two-part accuracy specification to take advantage of the upper-scale accuracy and yet maintain a reasonable specification for the lower portion of the scale.

Selecting an Analog Voltmeter

1. For measurements involving dc applications, select the instrument with the broadest capability meeting your requirements.
2. For ac measurements involving sine waves with only modest amounts of distortion (<10%), the average-responding voltmeter can perform over a bandwidth extending to several megahertz.
3. For high-frequency measurements (>10 MHz), the peak-responding voltmeter with the diode-probe input is the most economical choice. Peak-responding circuits are acceptable if inaccuracies caused by distortion in the input waveform can be tolerated.
4. For measurements where it is important to determine the effective power of waveforms that depart from a true sinusoidal form, the True RMS-responding voltmeter is the appropriate choice.

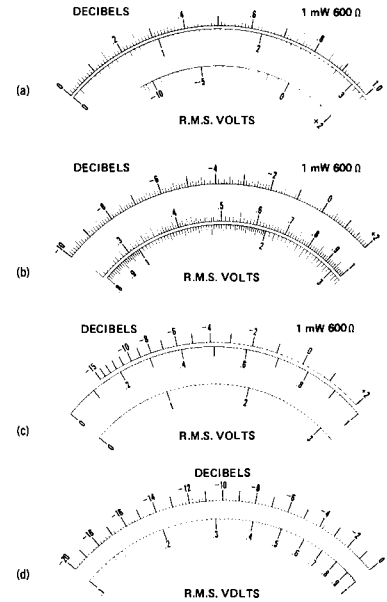

Figure 1. Four different types of meter scales available. (a) Linear 0-3 V and 0-10 V scales plus a dB scale. (b) Linear dB scale plus non-linear (logarithmic) voltage scales. (c) dB scale placed on larger arc for greater resolution. (d) Linear -20 to 0 dB scale useful for acoustical and communications applications.

Analog Voltmeter Selection Chart

Model	DC VOLTMETERS	Voltage Range	Frequency Range; Accuracy at FS*	Page
419A	DC NULL VOLTMETER	±3 μV to ±1 kV end scale 0.1 μV resolution (18 ranges)	dc ±(2% + 0.1 μV)	70
Model	AC VOLTMETERS	Voltage Range	Frequency Range; Typical Accuracy	Page
403B	RECHARGEABLE BATTERY AC VOLTMETER	1 mV to 300V (12 ranges)	5 Hz to 2MHz; ±2% to ±5%	74
400F 400 FL	FAST-RESPONSE AC VOLTMETER 100 kHz low-pass filter ac amplifier	100 μV to 300 V; -90 dB to +52 dB	20 Hz to 4 MHz; ±1% to ±4%	75
400GL	HIGH ACCURACY dB VOLTMETER 20 dB log scale (0 dB = 1 V)	-100 dB to +60 dB (8 ranges)	20 Hz to 4 MHz; ±0.2 dB to 0.4 dB	75
400E 400 EL	HIGH ACCURACY AC VOLTMETER has dc output (±0.5%) for driving recorder	1 mV to 300 V; -70 dB to +52 dB	10 Hz to 10 MHz ±1% ±5%	75
3400A	RMS VOLTMETER provides rms readings of complex signals. Has dc output for driving DVM's or recorders	1 mV to 300 V (12 ranges)	10 Hz to 10 MHz ±1% to ±5%	76
3406A	SAMPLING RF VOLTMETER provides True RMS measurements when used with 3400A. Many accessories	1 mV to 3 V (8 ranges)	10 kHz to >1.2 GHz ±3% to ±13%	77
Model	MULTI-FUNCTION METERS	Voltage Range (Accuracy)	Resistance Range (Accuracy)	Page
427A	BATTERY-OPERATED MULTI-FUNCTION METER has 10 MΩ dc input impedance and 10MΩ/20 pF ac input impedance	DC: ±100 mV to 1000 V (±2%) 9 ranges AC: 10 mV to 300 V 20 Hz to 1 MHz (±2%) 10 ranges	10Ω to 10 MΩ mid-scale ±5%; from 0.3 to 3 on the meter scale (7 ranges)	72
410C	VERSATILE VOLTMETER has 100 MΩ dc input impedance and 10 MΩ/1.5 pF ac impedance	DC: ±15 mV to ±1500 V (±2%) 11 ranges AC: 0.5 V to 300 V 20 Hz to >700 MHz (±3% at 400 Hz) 7 ranges	10Ω to 10 MΩ (center scale) 0 to midscale: ±5% or ±2% of midscale (whichever is greater) 7 ranges current: DC: ±1.5 μA to ±150 mA (±3%)	73
Model	CURRENT METERS	Current Range	Frequency Range	Page
428B	DC MILLIAMMETER with clip-on probe eliminates direct connection	1 mA to 10 A FS (9 ranges)	dc to 400 Hz	71

*For exact accuracy refer to page designated.

ANALOG VOLTMETERS

DC Null Volt-Ammeter

Model 419A

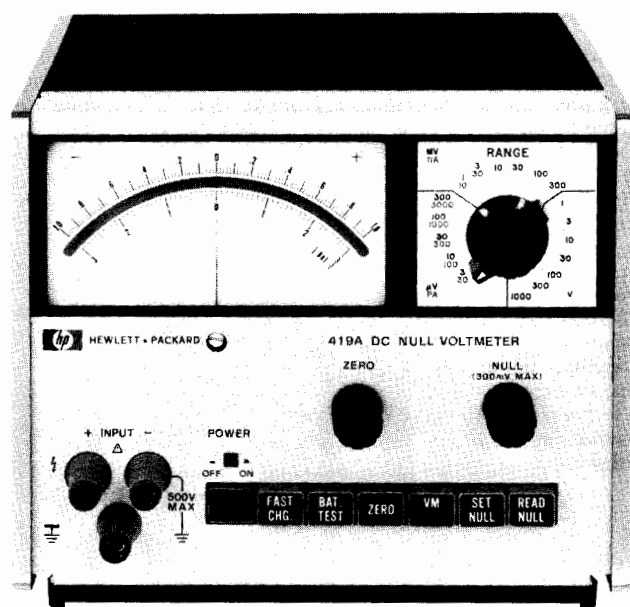

Description

Eighteen voltage ranges with $0.1 \mu\text{V}$ resolution on the lowest range. Accuracy of this rechargeable battery-operated instrument is $\pm 2\%$ of end scale $\pm 0.1 \mu\text{V}$ on all ranges. Noise is less than $0.3 \mu\text{V}$ p-p, and drift is less than $0.5 \mu\text{V}/\text{day}$.

An internal nulling voltage allows input voltages up to 300 mV to be nulled giving an infinite input impedance. Input impedance above 300 mV range is 100 megohms.

Seven pushbuttons allow rapid function selection. This dc null voltmeter operates from an ac line or from internal rechargeable batteries. During operation from ac line, batteries are trickle-charged. A fast-charge pushbutton is provided to increase the charging rate, recharging batteries in approximately 16 hours. Battery voltage may be checked with the battery-test pushbutton. The zero pushbutton allows compensation for any internal offsets before measurement. When this pushbutton is depressed, the positive leg of the voltmeter is disconnected from the positive input terminal.

When the voltmeter pushbutton is depressed, HP 419A functions as a zero-center scale $3 \mu\text{V}$ to 1000 V dc voltmeter.

When the AM pushbutton is depressed, HP 419A functions as a zero-center scale 30 pA to 30 nA ammeter.

Specifications

DC Null Voltmeter

Ranges: $\pm 3 \mu\text{V}$ to $\pm 1000 \text{ V}$ dc in 18 zero-center ranges.

Accuracy: $\pm (2\% \text{ of range} + 0.1 \mu\text{V})$.

Zero control range: $> \pm 15 \mu\text{V}$.

Zero drift: $< 0.5 \mu\text{V}/\text{day}$ after 30 min warm-up.

Zero temperature coefficient: $< 0.05 \mu\text{V}/^\circ\text{C}$.

Response time: 3 s to within 95% of final reading on $3 \mu\text{V}$ range; 1 s to within 95% of final reading on $10 \mu\text{V}$ to 1000 V ranges.

Noise: $< 0.3 \mu\text{V}$ p-p, input shorted. Noise amplitude approximates Gaussian distribution. RMS value (standard deviation) is $< 0.075 \mu\text{V}$, p-p noise value is $< 0.3 \mu\text{V}$ 95% of the time.

Input Characteristics

At null: infinite resistance on $3 \mu\text{V}$ through 300 mV ranges in set null mode. Negative input terminal can be floated to $\pm 500 \text{ V}$ dc from power line ground.

Off null

Voltage range	Input resistance
$3 \mu\text{V} - 3 \text{ mV}$	100 k Ω
$10 \text{ mV} - 30 \text{ mV}$	1 M Ω
$100 \text{ mV} - 300 \text{ mV}$	10 M Ω
$1 \text{ V} - 1000 \text{ V}$	100 M Ω

Negative input terminal can be floated up to $\pm 500 \text{ V}$ dc from power-line ground.

AC normal mode rejection: ac voltages 50 Hz and above and 80 dB greater than end scale affect reading $< 2\%$. Peak ac voltage not to exceed maximum overload voltage.

DC Ammeter

Ranges: $\pm 30 \text{ pA}$ to $\pm 30 \text{ nA}$ in 7 zero-center ranges.

Accuracy: $\pm (3\% \text{ of range} + 1 \text{ pA})$.

Zero control range: $> \pm 150 \text{ pA}$.

Zero drift: $< 5 \text{ pA}/\text{day}$ after 30 min warm-up.

Zero temperature coefficient: $< 0.5 \text{ pA}/^\circ\text{C}$.

Noise: $< 3 \text{ pA}$ p-p, input shorted.

Input resistance: 100 k Ω on all ranges.

Amplifier

Gain: 110 dB on $3 \mu\text{V}$ range, decreases 10 dB per range.

Output: 0 to $\pm 1 \text{ V}$ at 1 mA maximum for end-scale reading. Output level adjustable for convenience when used with recorders.

Output resistance: depends on setting of output level control. $< 35\Omega$ when output control is set to maximum.

Noise: 0.01 Hz to 5 Hz: same as voltmeter (referred to input). $> 5 \text{ Hz}$: $< 10 \text{ mV}$ RMS (referred to output).

General

Overload protection: the following voltages can be applied without damage to instrument.

1 V to 1000 V range: 1200 V dc.

10 mV to 300 mV range: 500 V dc.

3 μV to 300 mV range: 50 V dc.

Operating temperature: instrument will operate within specifications from 0°C to 50°C .

Operating humidity: $< 70\%$ R.H.

Storage temperature: -20°C to $+50^\circ\text{C}$.

Power: 115 V or 230 V $\pm 10\%$, 48 Hz to 440 Hz, 2 VA max. or 4 internal rechargeable batteries (furnished). 30-hr operation per recharge. Operation from ac line permissible during recharge.

Size: 156 mm H (without removable feet), 197 mm W, 203 mm D (6.1" x 7.75" x 8").

Weight: net, 3.7 kg (8.3 lb). Shipping, 5.4 kg (12 lb).

419A DC Null Volt-Ammeter

\$1550

ANALOG VOLTMETERS

1 mA to 10 A Clip-On dc Milliammeter

Model 428B

71



- No circuit interruption
- No circuit loading



428B



3529A

Description

Direct current from 1 milliampere to 10 amperes full scale can be measured without interrupting your measured circuit or producing loading errors. With the HP Model 428B Clip-on Milliammeter, cutting wires for insertion of current meters and calculating current from voltage and resistance readings are eliminated. All that is required for fast, accurate readings is to clip around the wire and select the proper current range.

The 428B measures current by utilizing a clip-on transducer that converts the magnetic field around the conductor to an ac voltage proportional to dc current. This voltage is detected and displayed as direct current on the 428B's meter. Since there is no direct contact with the circuit being measured, complete dc isolation is assured.

The meter responds to dc current only and is therefore not susceptible to common mode currents. However, low frequency currents up to 400 Hz can be measured by connecting an oscilloscope or voltmeter to the convenient front panel output; or this output can be used to drive a strip chart recorder for permanent long term records.

For even greater sensitivity, several loops of the measured conductor can be put through the probe, increasing sensitivity by the same factor as the number of turns used.

Specifications

DC current range: 1 mA to 10 A full scale, nine ranges.

Accuracy: $\pm 3\%$ of full scale ± 0.15 mA, from 0°C to 55°C (when instrument is calibrated to probe).

Probe inductance: $< 0.5 \mu\text{H}$.

Probe inducted voltage: < 15 mV p (worst case at 20 kHz and harmonics).

Output: variable linear output level with switch position for calibrated 1 V into open circuit (corresponds to full scale deflection). 1.5 V

max. into open circuit in uncalibrated position. $0.73 \pm .01$ V into 1 k Ω in calibrated position.

Noise: 1 mA range, < 15 mV rms across 1 k Ω ; 3 mA range, < 5 mV rms across 1 k Ω ; 10 mA through 10 A ranges, < 2 mV rms across 1 k Ω .

Frequency range: dc to 400 Hz (3 dB point).

AC rejection: signals > 5 Hz with pk value $<$ full scale affect meter accuracy $< 2\%$ (except at 40 kHz carrier frequency and its harmonics). On the 10 A range, ac pk value is limited to 4 A.

Power: 115 or 230 V $\pm 10\%$, 50 to 60 Hz, approx. 75 V A max.

Operating temperature range: -20°C to $+55^\circ\text{C}$.

Storage temperature: -40°C to $+65^\circ\text{C}$.

Probe insulation: 300 V maximum.

Probe tip size: $\approx 0.5"$ (12.7mm) by $0.66"$ (16.67mm) aperture diameter $0.16"$ (3.97mm).

Size: cabinet: 292 H x 191 W x 368 mm D (11.5" x 7.5" x 14.5").

Weight: net, 8.6 kg (19 lb). Shipping, 10.9 kg (24 lb).

Accessories Available

3529A Magnetometer Probe: this probe measures magnetic field strength and direction. The component of magnetic field sensed is parallel to the cylindrical axis of the probe. Applications include the testing of magnetic materials for air shipment.

Range: 1 mG to 10 G full scale, nine ranges.

1 mG = 1 mA conversion factor.

Accuracy: $\pm 3\%$ of full scale (0°C to $+55^\circ\text{C}$) after calibration.

Frequency range: dc to 80 Hz (3 dB point).

Weight: net 0.45 kg (1lb). Shipping 0.91 kg (2 lb).

Ordering Information

3529A Magnetometer Probe

428B Analog Milliammeter (cabinet)

Price

\$200

\$1675

ANALOG VOLTMETERS

Low-Cost Multi-Function Meter

Model 427A

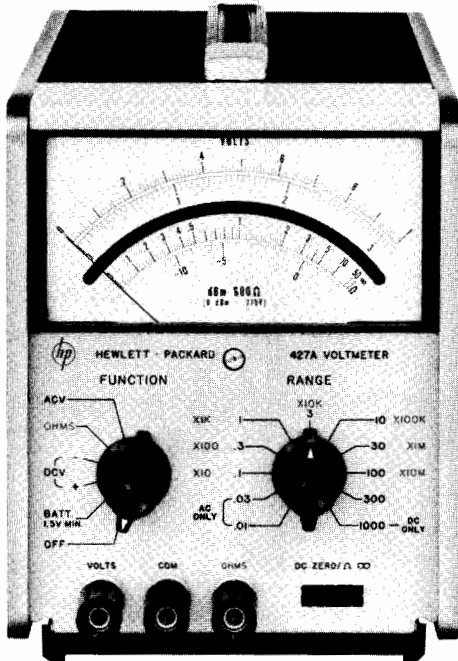

427A

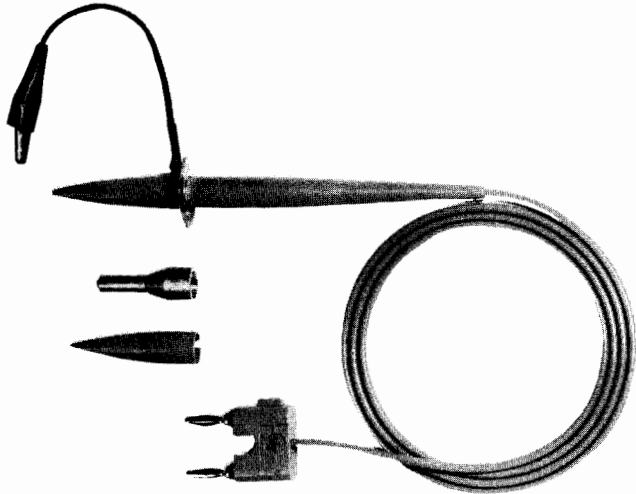

11096B

Description

Hewlett-Packard's Model 427A is a portable, versatile, low cost multi-function meter which is valuable in any laboratory, production line, service department, or in the field. It is capable of measuring dc voltages from 100 mV to 1 kV full scale; ac voltage from 10 mV to 300 V full scale at frequencies up to 1 MHz (>500 MHz with the 11096B High Frequency Probe); and resistance from 10Ω to 10 MΩ center scale.

The 427A will operate continuously for more than 300 hours on its internal 22.5 V dry cell battery. AC line and battery operation is available with option 001.

Specifications

DC Voltmeter

Ranges: ±100 mV to ±1000V in 9 ranges in 10 dB steps.

Accuracy: ±2% of range.

Input resistance: 10 MΩ.

AC normal mode rejection (ACNMR): ACNMR is the ratio of the normal mode signal to the resultant error in readout. 50 Hz and above: >80 dB.

Overload protection: 1200 V dc.

AC Voltmeter

Ranges: 10 mV to 300 V in 10 ranges in 10 dB steps.

Frequency range: 10 Hz to 1 MHz.

Response: responds to average value, calibrated in rms.

Accuracy:

Frequency	Range	
		0.01 V to 30 V
10 Hz to 100 kHz	2% of range	
100 kHz to 1 MHz	2% of range	

Input impedance: 10 mV to 1 V range, 10 MΩ shunted by <40 pF; 3 V to 300 V range, 10 MΩ shunted by <20 pF.

Overload protection: 300 V rms momentarily, 1 V range and below; 425 V rms max above 1 V range.

Ohmmeter

Ranges: 10Ω to 10 MΩ center scale in 7 decade ranges.

Accuracy: ± 5% of reading (from 0.3 to 3 on scale)

Source current (ohms terminal positive)

Range	Open circuit Voltage	Short circuit Current
X 10	0.1 V	10 mA
X 100	0.1 V	1 mA
X 1 k	1 V	1 mA
X 10 k	1 V	100 μA
X 100 K	1 V	10 μA
X 1 M	1 V	1 μA
X 10 M	1 V	0.1 μA

General

Input: may be floated up to ± 500 V dc above chassis ground. Ohms input open in any function except ohms. Volts input open when instrument is off.

Operating temperature: 0°C to 50°C.

Power: >300 hr operation per battery.

HP 427A. 22.5 V dry cell battery, Eveready No. 763 or RCA VS102. HP 427A Option 001: battery operation or ac line operation, selectable on rear panel. 115 V or 230 V ± 20%, 48 Hz to 440 Hz, 2 VA max.

Size: (standard 1/2 module): 159 mm H (without removable feet), 130 mm W, 203 mm D (6.25" x 5.13" x 8").

Weight: net, 2.4 kg (5.3 lb). Shipping, 3.6 kg (8 lb).

Accessories Available

HP 11096B High Frequency AC Probe extends range to >500 MHz. With the 11096B, you can measure 0.25 to 30 V rms signals out to 500 MHz with better than ± 1 dB accuracy. Usable relative measurements can be made up to 1 GHz (3 dB point at 700 MHz). The 11096B is a peak-responding detector calibrated to produce a dc output proportional to the rms value of a sine wave input. Input impedance is 4 MΩ shunted by 2 pF.

Options and Accessories

	Price
11075A High Impact Case. A rugged case for carrying, storing and operating the 427A	\$200
11096B High Frequency AC probe	\$120
11001A 45" test lead, dual banana plug to male BNC	\$20
11002A 60" test lead, dual banana plug to alligator clips	\$17
11003A 60" test lead, dual banana plug to pencil probe and alligator clip.	\$15
10111A BNC female to dual banana adapter	\$25

Ordering Information

427A Multi-function Meter (includes batteries)	\$850
427A Option 001 AC power supply & battery	add \$60

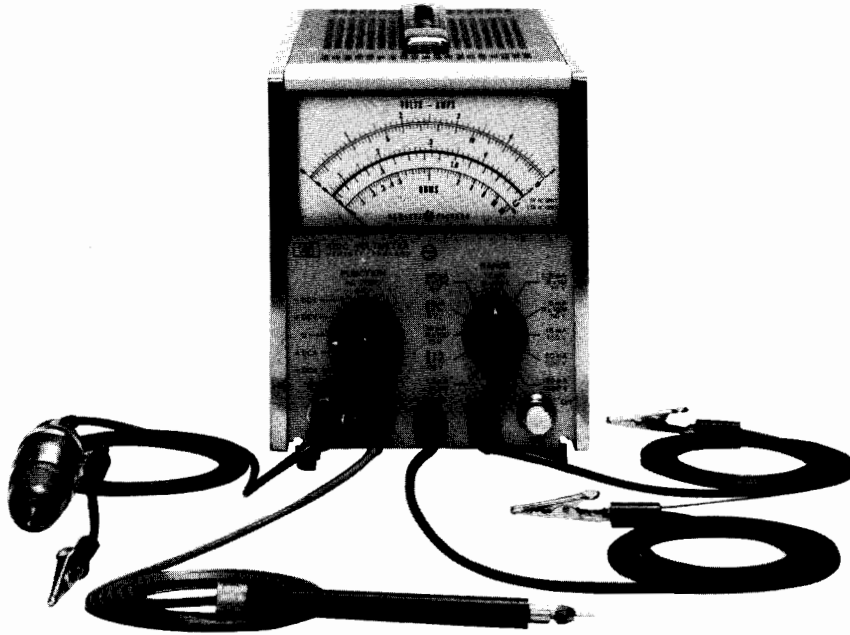

410C with 11036A

Description

HP's Model 410C is a versatile general purpose instrument for use anywhere electrical measurements are made. This instrument measures dc voltages from 15 mV to 1500 V, dc current from 1.5 μ A to 150 mA, and resistance from 0.2 Ω to 500 M Ω . With a standard plug-in probe, ac voltages at 20 Hz to 700 MHz from 50 mV to 300 V and comparative indications to 3 GHz are attainable.

Specifications

DC Voltmeter

Voltage ranges: ± 15 mV to ± 1500 V full scale in 15, 50 sequence (11 ranges).

Accuracy: $\pm 2\%$ of full scale on any range.

Input resistance: 100 M Ω $\pm 1\%$ on 500 mV range and above, 10 M Ω $\pm 3\%$ on 150 mV range and below.

AC Voltmeter

Voltage ranges: 0.5 V to 300 V full scale in 0.5, 1.5, 5 sequence (7 ranges)

Frequency range: 20 Hz to 700 MHz.

Accuracy: $\pm 3\%$ of full scale at 400 Hz for sinusoidal voltages from 0.5 V–300 V rms. The ac probe responds to the positive peak-above-average value of the applied signal. The meter is calibrated in rms.

Frequency response: $\pm 2\%$ from 100 Hz to 50 MHz (400 Hz ref.); 0 to -4% from 50 MHz to 100 MHz; $\pm 10\%$ from 20 Hz to 100 Hz and ± 1.5 dB from 100 MHz to 700 MHz.

Input impedance: input capacitance 1.5 pF, input resistance > 10 M Ω at low frequencies. At high frequencies, impedance drops off due to dielectric loss.

Safety: the probe body is grounded to chassis at all times for safety. All ac measurements are referenced to chassis ground.

DC Ammeter

Current ranges: ± 1.5 μ A to ± 150 mA full scale in 1.5, 5 sequence (11 ranges).

Accuracy: $\pm 3\%$ of full scale on any range.

Input resistance: decreasing from 9 k Ω on 1.5 μ A range to approximately 0.3 Ω on the 150 mA range.

Special current ranges: ± 1.5 , ± 5 and ± 15 nA may be measured on the 15, 50 and 150 mV ranges using the dc voltmeter probe, with $\pm 5\%$ accuracy and 10 M Ω input resistance.

Ohmmeter

Resistance range: resistance from 10 Ω to 10 M Ω center scale (7 ranges).

Accuracy: zero to midscale: $\pm 5\%$ of reading or $\pm 2\%$ of midscale, whichever is greater; $\pm 7\%$ from midscale to scale value of 2; $\pm 8\%$ from scale value of 2 to 3; $\pm 9\%$ from scale value of 3 to 5; $\pm 10\%$ from scale value of 5 to 10.

Amplifier

Voltage gain: 100 maximum.

AC rejection: 3 dB at 0.5 Hz; approximately 66 dB at 50 Hz and higher frequencies for signals < 1600 V p or 30 times full scale, whichever is smaller.

Isolation: impedance between common and chassis is > 10 M Ω in parallel with 0.1 μ F. Common may be floated up to 400 V dc above chassis for dc and resistance measurements.

Output: proportional to meter indications; 1.5 V dc at full scale, maximum current, 1 mA.

Output impedance: $< 3\Omega$ at DC.

Noise: $< 0.5\%$ of full scale/on any range (p-p).

DC drift: $< 0.5\%$ of full scale/yr at constant temperature. $< 0.02\%$ of full scale/ $^{\circ}$ C.

Overload recovery: recovers from 100:1 overload in < 3 s.

General

Maximum input: (see overload recovery). DC: 100 V on 15, 50 and 150 mV ranges, 500 V on 0.5 to 15 V ranges, 1600 V on higher ranges. AC: 100 times full scale or 450 V p whichever is less.

Power: 115 V or 230 V $\pm 10\%$, 48 Hz to 440 Hz, 13 VA (20 VA with 11036A ac probe).

Size: 165 mm H (without removable feet), x 130.2 mm W x 280 mm D (6 $\frac{1}{2}$ " x 5 $\frac{1}{8}$ " x 11") behind panel.

Weight: net, 4 kg (8 lb). Shipping, 5.44 kg (12 lb).

Accessories furnished: detachable power cord, 11036A AC probe.

Accessories available: see page 82.

Ordering Information

410C with HP 11036A Detachable AC probe

410C Option 002 (less ac probe)

Price

\$1600

less \$60

ANALOG VOLTMETERS

5 Hz to 2 MHz AC Solid-State Voltmeters

Model 403B

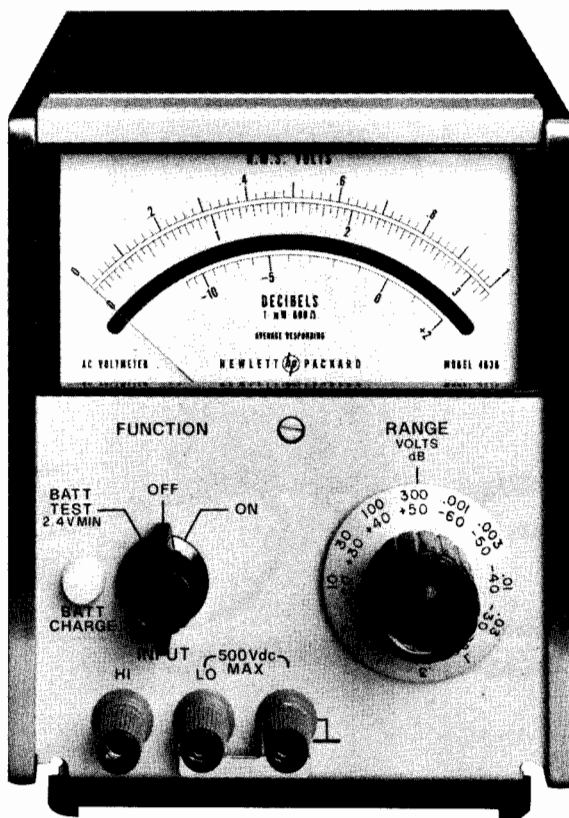

Description

The Hewlett-Packard 403B AC Voltmeter is a versatile, general purpose instrument for laboratory and production work, yet is ideal for use in the field since it is solid-state, battery operated, and portable.

It measures from 100 microvolts to 300 volts, covering 5 Hz to 2 MHz. It operates from internal batteries and thus may be completely isolated from the power line and external grounds, permitting accurate measurements at power line frequency and its harmonics without concern for beat effects. Isolation from external ground also permits use where ground loops are troublesome. Turnover effect and waveform errors are minimized because the meter responds to the average

value of the input signal.

The 403B operates from an AC line as well as from the internal battery pack, and batteries recharge during AC operation. Battery charge may be easily checked with a front-panel switch to assure reliable measurements. Normally, about 60 hours of AC operation recharges the batteries; but an internal adjustment is provided which nearly doubles the charging rate. The Model 403B can be used while its batteries charge. A sturdy taut-band meter eliminates friction and provides greater precision and repeatability.

For improved resolution in dB measurements, the 403B Option 001 is available. This version spreads out the dB scale by making it the top scale of the meter.

Specifications

Range	0.001 to 300 V rms full scale, 12 ranges, in a 1, 3, 10 sequence. -60 dB to +50 dB in 12 ranges with 10 dB steps.
Meter	Responds to average value of input waveform, calibrated in the rms value of a sine wave.
Frequency Range	5 Hz to 2 MHz
Accuracy	Within $\pm 2\%$ (± 0.2 dB) of full scale from 10 Hz to 1 MHz; within $\pm 5\%$ (± 0.4 dB) of full scale from 5 to 10 Hz and from 1 to 2 MHz, except $\pm 10\%$ (± 0.8 dB) from 1 to 2 MHz on the 300 V range (0 to 50°C).*
Input Impedance	2 M Ω ; shunted by <60 pF, 0.001 to 0.03 V ranges; <30 pF, 0.1 to 300 V ranges.
Maximum Input	Fuse protected (signal ground can be ± 500 V DC from chassis).
Power	4 rechargeable batteries, 40 hr. operation per recharge, up to 500 recharging cycles; self-contained recharging circuit functions during operation from AC line.
Size	159 mm H (without removable feet) x 130 mm W x 203 mm D (6.25" x 5.13" x 8").
Weight	net, 2.9 kg (6.5 lb). Shipping, 3.6 kg (8 lb).
Price	403B: \$800 Opt 001: add \$50

*Use 10001A 10:1 Divider and 10111A Adapter to retain $\pm 5\%$ (± 0.4 dB) accuracy while measuring up to 425 V rms from 1 to 2 MHz.

ANALOG VOLTMETERS

AC Voltmeter, 10 Hz to 10 MHz

Models 400E, EL, F, FL, GL

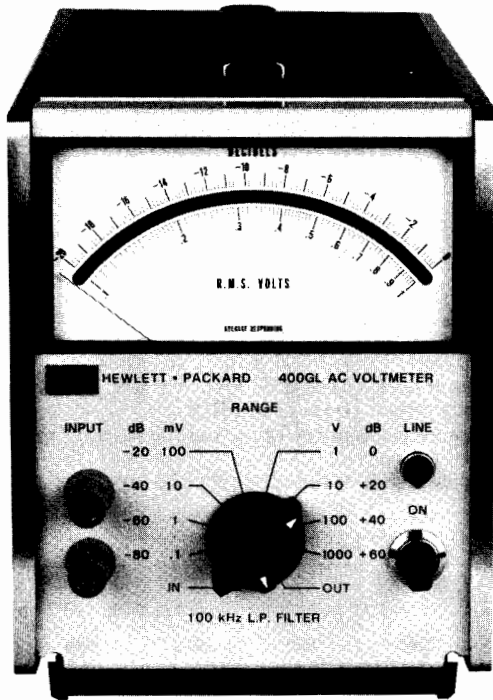

400GL

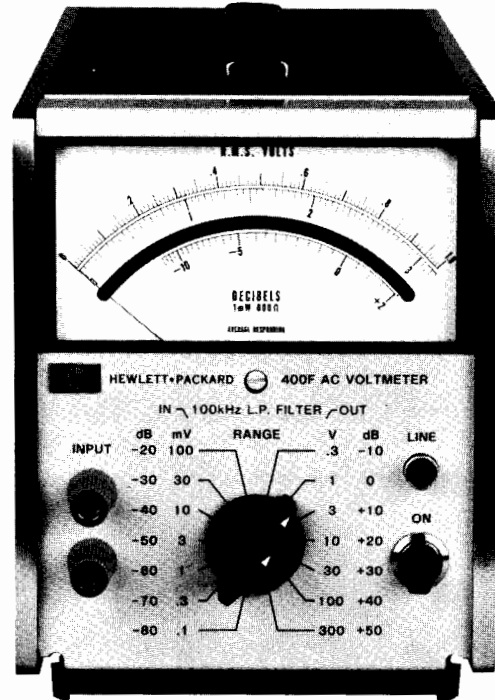

400F

Specifications

	400E/EL*	400F/FL*	400 GL
Voltage range	1 mV to 300 V F.S. 12 ranges	100 μ V to 300 V F.S. 14 ranges	-80 dB to +60 dB F. S. 8 ranges
Frequency range	10 Hz-10 MHz	20 Hz-4MHz	20 Hz-4 MHz
Input impedance	10 M Ω on all ranges <25 pF to <12 pF depending on ranges	10 M Ω on all ranges <30 pF to <15 pF depending on ranges	10 M Ω on all ranges <30 pF to <15 pF depending on ranges
Accuracy*	\pm (% reading + % range) 3 mV-300 V ranges 10 Hz-40 Hz: \pm (2.5 + 2.5) 40 Hz-2 MHz: \pm (1 + 0) 2 MHz-4 MHz: \pm (1.5 + 1.5) 4 MHz-10 MHz 3 mV range: \pm (2.5 + 2.5) 10 mV-3V range: \pm (3.0 + 2.0) for 4 MHz to 6 MHz \pm (3.75 + 3.75) for 6 MHz to 10 MHz 10 V-30 V: \pm (3.5 + 3.5) 1 mV range 10 Hz-40 Hz: \pm (2.5 + 2.5) 40 Hz-500 kHz: \pm (1 + 0) 500 kHz-4 MHz: \pm (2.5 + 2.5)	\pm (% reading + % range) 300 μV-300 V ranges 20 Hz-40 Hz: \pm (2 + 2) 40 Hz-100 Hz: \pm (1 + 1) 100 Hz-1 MHz: \pm ($\frac{1}{2}$ + $\frac{1}{2}$) 1 MHz-2 MHz: \pm (1 + 1) 2 MHz-4 MHz: \pm (2 + 2) 100 μV range 30 Hz-60 Hz: \pm (2 + 2) 60 Hz-100 kHz: \pm (1 + 1) 100 kHz-500 kHz: \pm (1 + (+0, -7))	+60 dB range 20 Hz-40 kHz: \pm 0.4 dB 40 kHz-100 kHz: \pm 0.2 dB -60 dB thru +40 dB ranges 20 Hz-40 Hz: \pm 0.4 dB 40 Hz-500 kHz: \pm 0.2 dB 500 kHz-2 MHz: \pm 0.4 dB 2 MHz-4 MHz: +0.2, -0.8 dB -80 dB range 30 Hz-60 Hz: \pm 0.4 dB 60 Hz-100 kHz: \pm 0.2 dB 100 kHz-500 kHz: + 0.2, -0.8 dB
Recovery	<2 s for 80 dB overload		
Overload	**500 V rms ac, 300 V dc		**1200 V rms max. input; 1000 V dc max. input
Calibration	Scale -10 to +2 dB between ranges, 100 divisions on 0 to 1 scale. The dB scale reads -10 to +2 dB; 10 dB between ranges.		Linear dB scale, 100 divisions from -20 to 0 dB. Long voltage scale 0 dB = 1V.
Weight	Net, 2.7 kg (6 lb). Shipping, 4.1 kg (9 lb)		
Size	159 mm H (without removable feet) x 130 mm W x 279 mm D (6.25" x 5.13" x 11")		
Power	AC: 115 or 230 V +10%, 48 to 440 Hz, 6 VA max. DC: External batteries: + and - voltages between 35 V and 55 V		
Price:	400E, \$825; 400 EL \$850	400F, \$825; 400 FL, \$850	400 GL, \$850

* NOTE: 400 EL same as 400E, and 400FL same as 400F, except for calibration. Linear dB scale -10 dB to +2 dB, 10 dB between ranges. Log voltage scales 0.3 to 1 and 0.8 to 3, 120 divisions from -10 dB +2 dB. 400 FL accuracy is % of reading in dB only.

** AC overload voltage decreases with increasing frequency

ANALOG VOLTMETERS

10 Hz to 10 MHz True RMS Voltmeter

Model 3400A

- 10 MHz bandwidth
- High crest factor for accurate pulse measurements
- Stable, linear DC output

- 1 mV full-scale sensitivity
- 10 MΩ input impedance
- Taut-band individually calibrated meter

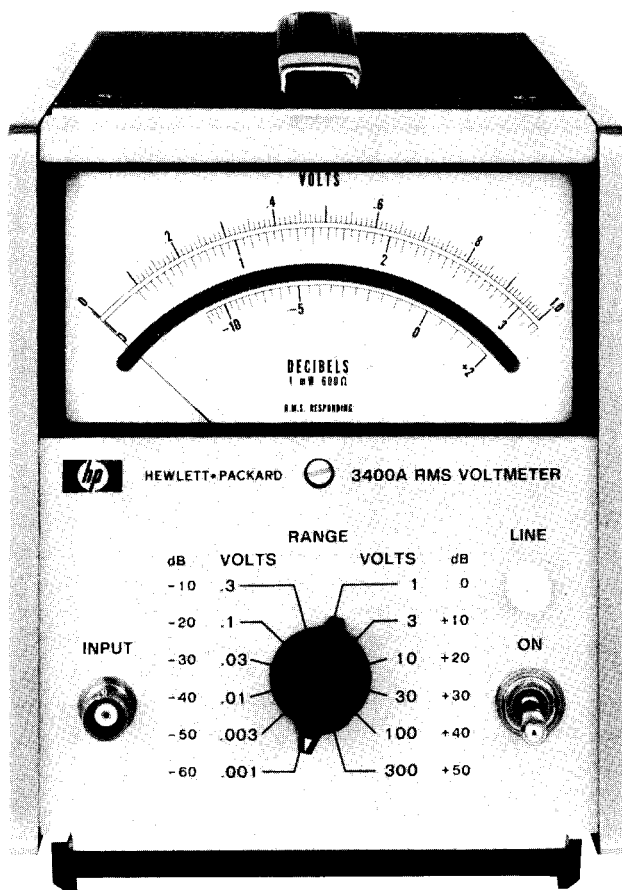

Description

The Hewlett-Packard Model 3400A is a true root-mean-square (rms) voltmeter, providing a meter indication proportional to the dc heating power of the input waveform.

Six-decade frequency coverage makes the 3400A extremely flexible for all audio and most RF measurements and permits the measurement of broadband noise and fast-rise pulses.

Pulses or other non-sinusoids with crest factors (ratio of peak to rms) up to 10:1 can be measured full scale. Crest factor is inversely proportional to meter deflection, permitting up to 100:1 crest factor at 10% of full scale.

Permanent plots of measured data and higher resolution measurements can be obtained by connecting an X-Y plotter, strip chart recorder or digital voltmeter to the convenient rear-panel dc output. The dc output provides a linear 0 to 1 volt drive proportional to meter deflection.

Specifications

Voltage range: 1 mV to 300 V full scale, 12 ranges.

DB range: -72 to +52 dBm (0 dBm = 1 mW into 600Ω).

Frequency range: 10 Hz to 10 MHz.

Response: responds to rms value (heating value) of the input signal for all waveforms.

Meter accuracy: % of full scale (20°C to 30°C)*

10Hz	50Hz	1MHz	2MHz	3MHz	10MHz
±5%	±1%	±2%	±3%	±3%	±5%

AC-to-DC converter accuracy: % of full scale (20°C to 30°C)*

10Hz	50Hz	1MHz	2MHz	3MHz	10MHz
±5%	±0.75%	±2%	±3%	±3%	±5%

* TC: ±0.1% from 0°C to 20°C and 30°C to 55°C.

Crest factor: (ratio of peak to rms amplitude of input signal): 10 to 1 at full scale (except where limited by maximum input) inversely proportional to meter deflection (e.g., 20 to 1 at half-scale, 100 to 1 at tenth scale).

Maximum continuous input voltage: 500 V ac peak at 1 kHz on all ranges; 600 V dc on all ranges.

Input impedance: from 0.001 V to 0.3 V range: 10 MΩ shunted by <50 pF. From 1.0 V to 300 V range: 10 MΩ shunted by <20 pF. AC coupled input.

Response time: for a step function, <5 s to final value.

AC overload: 30 dB above full scale or 800 V p, whichever is less, on each range.

Output: negative 1 V dc into open circuit at full-scale deflection, proportional to meter deflection from 10–100% of full scale. 1 mA maximum; nominal source impedance is 1000Ω. Output noise <1 mV rms.

Power: 115 or 230 V ±10%, 48 to 66 Hz, 15 VA max.

Size: 159 H (without removable feet) x 130 W x 279 mm D (6.25" x 5.1" x 11"); 1/2 module.

Weight: net, 3.3 kg (7.3 lb). Shipping, 4.5 kg (10 lb).

Accessories furnished: 10110A Adapter, BNC to dual banana jack.

Accessories Available

Accessories Available	Price
11001A Cable, 45 in. long, male BNC to dual banana plug	\$17
11170A Cable, 12 in., male BNC connectors	\$17
11170B Cable, 24 in., male BNC connectors	\$17
11170C Cable, 48 in., male BNC connectors	\$20
11002A Test lead, dual banana plug to alligator clips	\$15
11003A Test Leads, dual banana plug to probe and alligator clip	\$12
11076A Carrying Case	\$200

Ordering Information

3400A Opt 001 spreads out the dB scale by making it the top scale of the meter. add \$30

Rear terminals in parallel with front panel terminals and linear log scale uppermost on the meter face are available on special order.

3400A RMS Voltmeter

\$1275

ANALOG VOLTMETERS

10 kHz to 1.2 GHz RF Voltmeter

Model 3406A

77

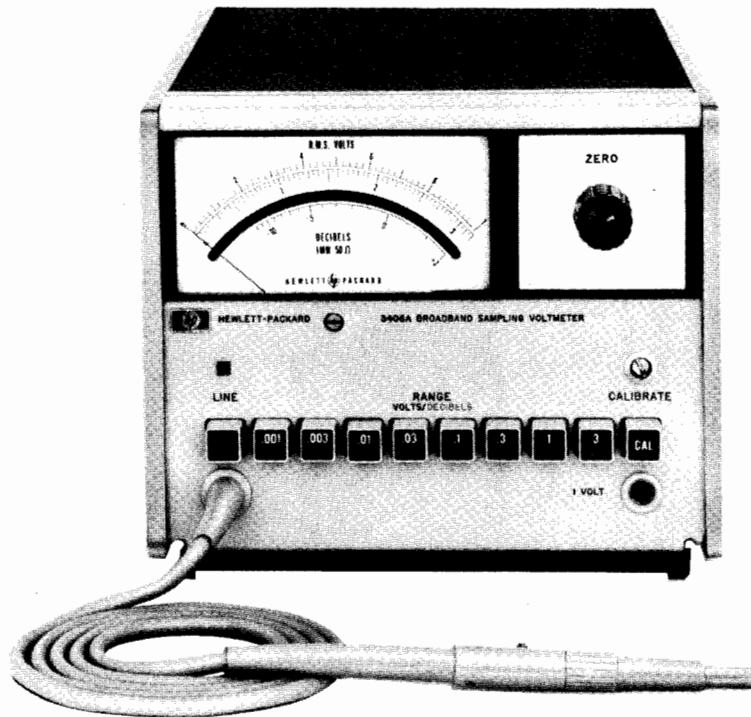

Description

High frequency voltages can be measured easily with HP's 3406A Sampling Voltmeter. Employing sampling techniques, the HP 3406A has extremely wide bandwidth (10kHz to 1.2 GHz) with high input impedance. Signals as small as 50 μ V can be resolved. Full scale sensitivity from 1 mV to 3 V is selected in eight 10 dB steps and may be read directly from -62 dBm to +23 dBm. Accessory probe tips convert the HP 3406A for voltage measurements in applications such as receivers, amplifiers and coaxial transmission lines.

Measurement can be retained on the 3406A meter by depressing a pushbutton located on the pen-type probe. This is useful when measurements are made in awkward positions where the operator cannot observe the meter indication and probe placement at the same time.

Specifications

Voltage range: 1 mV to 3 V full scale in 8 ranges; decibels from -50 to +20 dBm (0 dBm = 1 mW into 50 Ω); average-responding instrument calibrated to rms value of sine wave.

Frequency range: 10 kHz to 1.2 GHz; useful sensitivity from 1 kHz to beyond 2 GHz.

Full-scale accuracy (%) with appropriate accessory (after probe is properly calibrated)

10 kHz	20 kHz	25 kHz	100 kHz	100 MHz	700 MHz	1 GHz	1.2 GHz
± 13	± 8	± 5	± 3	± 5	± 8	± 13	

Input impedance: input capacity and resistance will depend upon accessory tip used. 100,000 Ω shunted by <2.1 pF at 100 kHz with bare probe; <10 pF with 11072A isolator tip supplied.

Sample Hold Output

Provides ac signal whose unclamped portion has statistics that are narrowly distributed about the statistics of the input, inverted in sign

(operating into >200 k Ω load with <1000 pF). Output is 0.316 V at f.s. on any range.

Noise: <175 μ V rms referred to input.

Accuracy (after calibration): 0.01 V range and above: same as full scale accuracy of instrument. 0.001 V to 0.003 V range: value of input signal can be computed by taking into account the residual noise of the instrument. Jitter: meter indicates within $\pm 2\%$ pk of reading 95% of time (as measured with HP 3400A True RMS Voltmeter).

RMS crest factor: 0.001 V to 0.3 V, 20 dB; 1 V, 13 dB; 3 V, 3 dB.

Meter

Meter scales: linear voltage, 0 to 1 and 0 to 3; decibel, -12 to +3. Individually calibrated taut-band meter.

Response time: Indicates within specified accuracy in <3 s.

Jitter: $\pm 1\%$ peak (of reading).

General

DC recorder output: adjustable from 0 to 1.2 mA into 1000 ohms at full scale, proportional to meter deflection.

Overload recovery time: meter indicates within specified accuracy in <5 μ s (30 V p-p max.).

Maximum input: ± 100 V dc, 30 V p-p.

RFI: conducted and radiated leakage limits are below those specified in MIL-6181D and MIL-I-16910C except for pulses emitted from probe. Spectral intensity of these pulses is nominally 50 nV/ $\sqrt{\text{Hz}}$; spectrum, extends beyond 2 GHz.

Temperature range: Instrument, 0 $^{\circ}$ C to +55 $^{\circ}$ C; probe, +10 $^{\circ}$ C to +40 $^{\circ}$ C.

Power: 115 or 230 V $\pm 10\%$, 48 Hz to 66 Hz, 25 VA max.

Size: 159 mm H (without removable feet), x 197 mm W x 279 mm D (6.25" x 7.75" x 11"); $\frac{1}{2}$ module.

Weight: net, 5.4 kg (12 lb). Shipping, 6.8 kg (15 lb).

Accessories: refer to data sheet.

3406A RF Voltmeter

\$2250

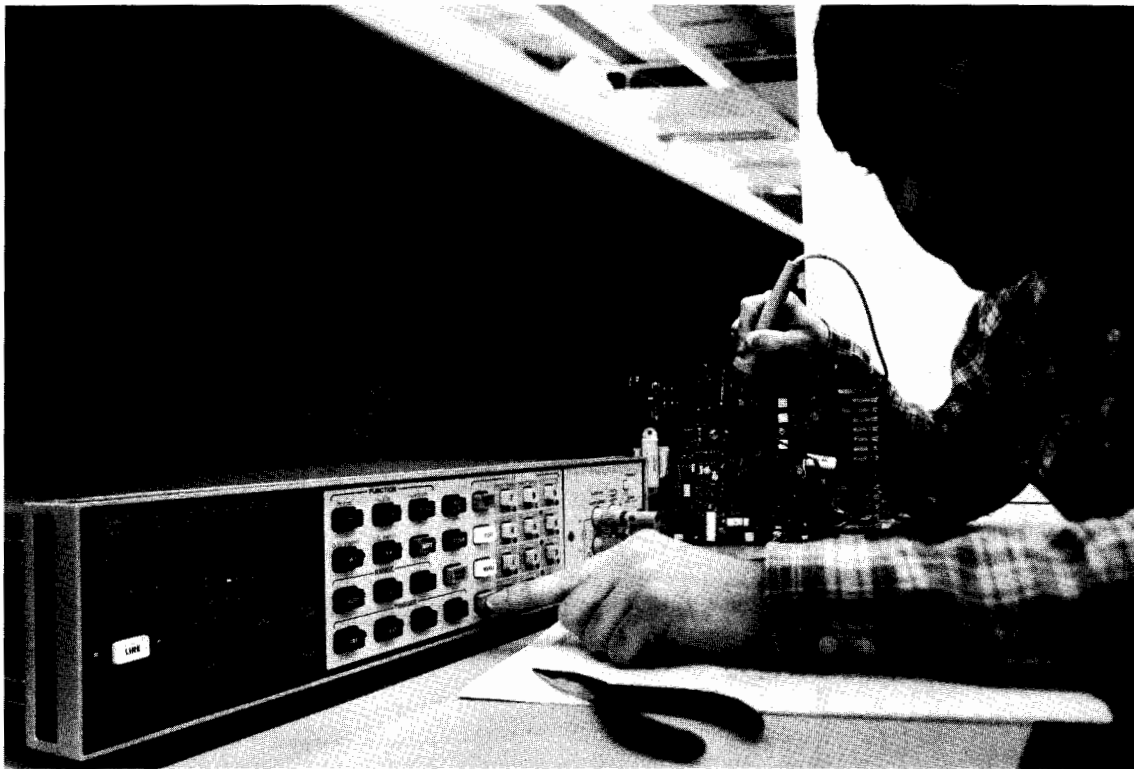

DVM's have historically been optimized for either a systems environment where speed is important or for bench applications where users want high accuracy, high resolution and low noise. HP's new 3456A Digital Voltmeter is able to function equally well in both application areas (see page 68) using a new multi-slope A/D conversion technique. There is the classical trade-off between speed and resolution. For quiet, stable readings with high normal mode noise rejection an integrating technique is the best approach. The speed of most integration techniques is limited by certain constraints. If a final reading can be developed during the measurement cycle, measurement speed can be increased. This explains why the successive approximation A/D technique is fast because the final reading is developed one digit at a time so that no final tally of counts is necessary at the end of the measurement. The trade-off, using the successive approximation technique, is to sacrifice noise rejection for speed.

New HP Multi-slope A/D Conversion Technique

A second speed limitation lies in the fact that microprocessors add and subtract a lot faster than they multiply. In HP's new multi-slope A/D technique, timing errors and leakage errors become offset errors which are removed quickly by microprocessor addition or subtraction.

The easiest way to understand HP's new A/D conversion technique is to look at the classical dual slope integration in Fig. 1. The input is applied to an integrator during run-up for a period related to the power line frequency. Measurement of the input is made

by applying a reference voltage of opposite polarity to the integrator. The time required for run-down until its zero crossing is proportional to the input voltage. Not until this final zero crossing is made is the magnitude of the input known.

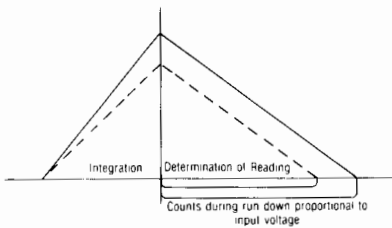

Figure 1. The classical dual-slope integration technique is limited in speed to how fast the zero crossing can be detected accurately. In addition, the final reading is not known until rundown has been completed. Note that the voltage remaining on the integrator's capacitor is proportional to input level.

The voltage left on the integrator's capacitor at the end of the integration period varies directly as a function of input level. For small inputs, noise becomes a problem and for large inputs, the dielectric absorption of the capacitor becomes a problem. The run-down speed could be improved by application of a steeper slope (reference voltage of larger magnitude, incorporating high speed logic).

The basic design contributions of HP's new multi-slope A/D technique are: 1) speed, 2) elimination of high speed logic in the zero comparator, 3) keeping the run-up slopes steep to effectively extend the range of the comparator, 4) completion of A/D conversion during the measurement and 5) conversion of gain errors and timing errors into offset errors where they can be subtracted out.

The run-down portion of HP's Multi-slope II technique is illustrated in Fig. 2. A steep

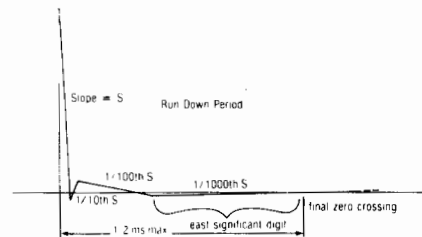

Figure 2. The Multi-slope II technique used in the 3456A Digital Voltmeter employs a four-slope rundown to successively establish the value of the four least significant digits in the final reading. Note that the final zero crossing which determines the least significant digits is done with the shallowest slope.

run-down is applied initially and a finite amount of overshoot is allowed intentionally. The next slope applied is exactly a decade less in steepness and opposite in polarity. After its zero crossing (with a finite amount of overshoot), a third slope a decade again less in steepness is applied. Then after its zero crossing, a fourth slope is applied which turns out to be one one-thousandth as steep as the initial slope.

The residual charge remaining on the integrator's capacitor after the conclusion of each slope represents what is left to digitize. At the beginning of each slope, a clock is started, then stopped at the zero crossing for that slope. The mathematics of the technique are such that the four least significant digits are developed sequentially during run-down from the stored counts for each of the four slopes.

Note that the steepest slope and the most poorly defined zero crossing is the least

critical in terms of the final reading. The usable sensitivity of the DVM is to a large degree determined by the final zero crossing for the least significant digit. This is determined by using the shallowest zero crossing having the greatest precision. Thus, HP's Multi-slope II technique develops the final reading during run-down rather than after run-down.

Looking next at run-up where integration is accomplished, Multi-slope II also makes its contribution. When the operator selects 100, 10 or 1 power line cycles of integration from the front panel of HP's 3456A DVM, the instrument is able to resolve six full digits with the first two established during run-up. If 0.1 power line cycles is selected, only five digit resolution is practical with the first (most significant) digit established during run-up and the remaining four determined during run-down. At 330 readings per second and 0.01 line cycles of integration, the HP 3456A has $4\frac{1}{2}$ digit resolution. At this speed, the integration period looks similar to dual slope as illustrated in Fig. 1.

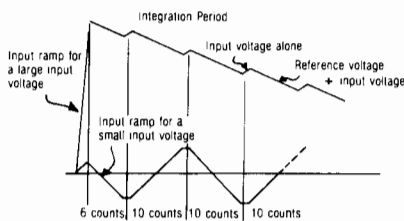

Figure 3. In multi-slope integration, the final voltage across the integrator capacitor was left at a fairly high level at the end of the integration period. In addition, the number of switch transitions varied greatly as a function of the input level.

Dual slope uses linear run-up where the input voltage is applied and allowed to ramp. Dual slope does not fully exploit the dynamic range of the integrator. In a multi-slope technique a sawtooth approach is used to keep the integrator charging at a fast rate. This was achieved by periodically switching in a reference of opposite polarity to ramp down as shown in Fig. 3. In this technique, the larger the input voltage, the larger the average voltage on the integrator capacitor and the more sensitive accuracy is to dielectric absorption. HP's Multi-slope II keeps the average voltage after run-up as low as practical. It, however, uses the sawtooth approach to maintain a high charging rate.

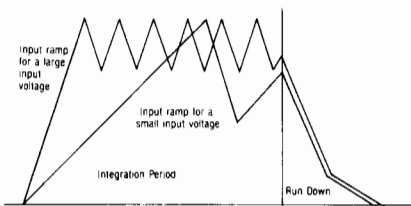
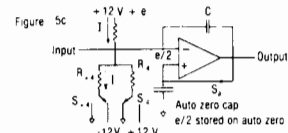
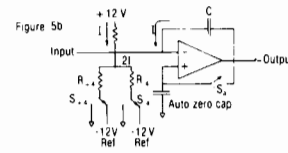
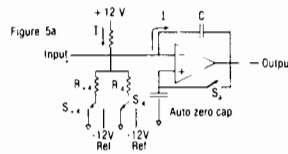

Figure 4. Multi-slope II as applied to HP's 3456A Digital Voltmeter uses a runup broken into fixed periods which do not vary no matter what the input level is. In addition, the average voltage on the integrator capacitor tends to be lower than with previous techniques, thus reducing the errors created by dielectric absorption. When resolving six full digits, the first two digits are established during this runup period.

One source of errors is variations in switching time, and if there is a lot of switching of the input and reference voltages, these errors can be considerable. In Fig. 4 the number of switching points during run-up using the multi-slope technique varies as a function of the magnitude of the input voltage. Full scale inputs produce the maximum number of switching points. With Multi-slope II these errors are removed because the number of transitions is held constant irrespective of the magnitude of the input voltage. Potential timing errors are then converted into offset errors which are removed. Fig. 4 illustrates how Multi-slope II handles a full scale input and a tenth of full scale input.

Easy Calibration

Another contribution of HP's multi-slope technique is the use of a single reference voltage to simplify calibration and lower cost. Due to the auto zero technique, both positive and negative ramps can be generated. Fig. 5a, b, and c show a simplified schematic to illustrate how this works. As shown in Fig. 5a, when both S_{+4} and S_{-4} are switched to ground, the current (I) flowing from the +12V supply will pass through the summing node and out to the integrator capacitor (C). Due to operational amplifier action, the summing node is a virtual ground. This generates a negative going ramp at the output of the integrator.



This abbreviated schematic of the integrator is shown for three different conditions: 5a) the generation of a negative-going ramp, 5b) the generation of a positive-going ramp and 5c) the conditions during analog auto zero.

When both S_{+4} and S_{-4} are closed to the -12V reference as illustrated in Fig. 5b, current is sucked away from the summing node at twice that supplied by the +12V supply. The balance of current required to achieve equilibrium in the node is removed from the integrator capacitor, generating a positive ramp on the output of the integrator.

Between measurement cycles, there is an analog auto zero performed. The cycle is shown in Fig. 5c, where S_{+4} is closed to the -12V reference but S_{-4} is switched to ground. Since the resistors (R) are of approximately equal value, any error in voltage from the +12V supply (e) will appear as $e/2$ at the summing node. With S_a closed, $e/2$ is stored on the auto zero capacitor.

During ramp generation, the auto zero

switch (S_a) is opened and the voltage ($e/2$) held on the auto zero capacitor elevates the positive input to the operational amplifier. Any error in absolute magnitude of the +12V supply is removed and the supply need only have good short term stability. Any error in the +12V supply is converted to an offset and subtracted during the measurement.

Small differences in R_{+4} and R_{-4} can be averaged out by alternating between the two during auto zero cycles. This, in effect, converts a potential gain error into an offset error removable during the auto zero cycle. Resistors R_{+4} and R_{-4} have a tolerance of 0.01%, but due to this technique, are effectively matched to within 1 ppm.

Zero comparators have some hysteresis. Not only are the switch transistors kept constant during run-down, but also the ramping is arranged so that the final and most critical zero crossing is made from the same direction. The application of both the S_{-4} and S_{+4} slopes are made for both the rundown of a positive voltage as well as a negative voltage on the integrator capacitor. This is illustrated in Fig. 6. Note also that the number of ramps which are required is limited to S_{-4} , S_{+4} , S_{-3} , S_{+2} and S_{-1} .

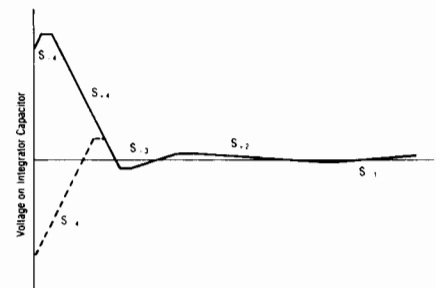

Figure 6. The artificial introduction of an extra S_{-4} slope during rundown keeps the switch transitions balanced between negative and positive inputs and also makes the final zero crossing from the same direction.

Offset Compensated Ohms

The ohms converter incorporated in HP's 3456A DVM uses a new technique called Offset Compensated Ohms. Thermal offsets generated by bimetallic junctions are a source of error in ohms measurements. When the ohms function is selected in HP's 3456A, the instrument first makes a normal ohms measurement and stores the result in memory. The constant current source is switched off next and a conventional voltage reading is made. Offsets detected during the voltage reading are subtracted from the voltage measured with the constant current source applied. The result is an offset compensated ohms measurement. The ohms converter capitalizes on the low noise, high accuracy, multi-slope A/D converter in the 3456A.

In summary, the design emphasis of HP's 3456A DVM provides the operator with a smart DMM to allow the operator to choose the performance level required, whether it is high resolution, high accuracy bench application or high speed systems use. The DMM Selection Chart on the next page can help you to select a DVM for your bench or systems application.

DVM SELECTION GUIDE

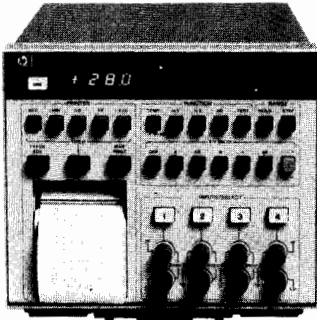

3467A

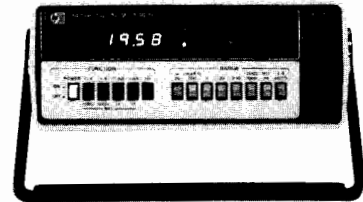

3435A



3476A/B



3465A/B



3466A

BENCH DVM'S

DVM's	Features	dc Volts					ac Volts	Resistance			Current		General			Price
		Max. Input	Rdgs/Sec	Ranges	Sensitivity	Basic Accuracy	Bandwidth	Ranges	Sensitivity	Open Circuit Voltage	ac	dc	Ranging	Over-range	Other	
3476A/B 3½ digit p 84	<ul style="list-style-type: none"> • Low cost • Autorange 	1000 V	3	100 mV to 1000 V	100 µV	±(.3% Rdg. + 1 count)	10 kHz	1 kΩ to 10 MΩ	1 Ω	< 4 V	Yes	Yes	Auto/Hold	10%	Battery Power 3476B	\$300/350
3435A 3½ digit p 86	<ul style="list-style-type: none"> • Accuracy • 10 milli Ω 	1200 V	4.7	100 mV to 1200 V	100 µV	±(.1% Rdg. + 1 count)	100 kHz	10 Ω to 10 MΩ	10 milli Ω	< 5 V	Yes	Yes	Auto/Manual	100%	Battery Power Opt 002	\$525
3465A/B 4½ digit p 88	<ul style="list-style-type: none"> • 1 µV sensitivity • Bench/Field 	1000 V	2.5	10 mV to 1000 V	1 µV	±(.02% Rdg. + 1 count)	20 kHz	100 Ω to 10 MΩ	10 milli Ω	< 5 V	Yes	Yes	Manual	100%	Battery Power 3465B	\$650/625
3466A 4½ digit p 90	<ul style="list-style-type: none"> • Autorange • True RMS • 1 µV sensitivity 	1200V	4.7	10 mV to 1200 V	1 µV	±(.03% Rdg. + 1 count)	100 kHz True rms	10 Ω to 10 MΩ	1 milli Ω	< 5 V	Yes True rms	Yes	Auto/Manual	100%	Battery Power Trrms/ac or dc	\$775
3467A 4½ digit p 92	<ul style="list-style-type: none"> • Temperature • Printer/Timer • 4 channels 	350 V	4.5	20 mV to 350 V	1 µV	±(.03% Rdg. + 1 count)	100 kHz True rms	200 Ω to 20 MΩ	10 milli Ω	< 5 V			Auto/Hold	100%	Total Measurement Station	\$2,600

DVM SELECTION GUIDE

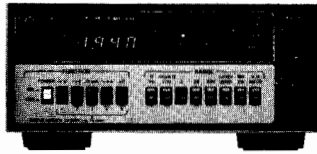

3438A

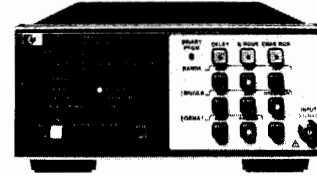

3437A

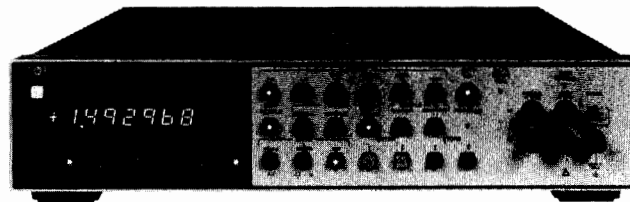

3455A

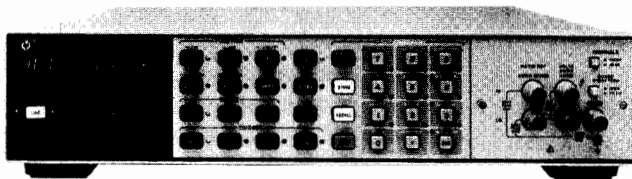

3456A

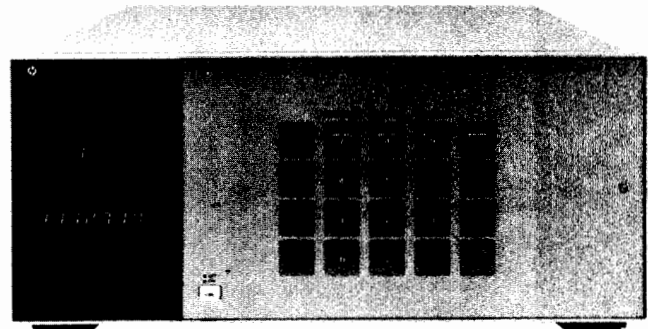

3497A

SYSTEM DVM'S

DVM's	Features	dc Volts				Basic Accuracy	Bandwidth	Resistance			Current		General			
		Max. Input	Rdgs/Sec	Ranges	Sensitivity			Ranges	Sensitivity	Open Circuit Voltage	ac	dc	Ranging	Over-range	Other	Price
3438A 3 1/2 digit p 96	<ul style="list-style-type: none"> HP-IB Low Cost 	1200 V	4.7	200 mV to 1200 V	100 μV	±(.1% Rdg. + 1 count)	100 kHz	10 Ω to 10 MΩ	10 milli Ω	< 5 V	Yes	Yes	Auto/Manual	100%	Five function HP-IB	\$1.050
3437A 3 1/2 digit p 98	<ul style="list-style-type: none"> HP-IB High speed Sample/Hold 	20 V	5700	100 mV to 10 V	100 μV	±(.03% Rdg. + 2 counts)							Manual	100%	HP-IB Int. timer Sample/Hold Hold	\$2.750
3455A 5 1/2, 6 1/2 digit p 104	<ul style="list-style-type: none"> HP-IB AutoCal 	1000 V	24	100 mV to 1000 V	1 μV	±(.002% Rdg. + 1 count)	1 MHz True rms	100 Ω to 10 MΩ	1 milli Ω	< 5 V			Auto/Manual	50%	HP-IB, guarded, 4 terminals, Math	\$4.250
3456A 3 1/2, 4 1/2, 5 1/2, 6 1/2 digit p 100	<ul style="list-style-type: none"> High Performance Selective integration time 	1000 V	330 (48 with 6 1/2 digits)	100 mV to 1000 V	100 nV	±(.0008% Rdg. + 2 counts)	250 kHz True rms	100 Ω to 1 GΩ	100 μΩ	< 9.5 V			Auto/Manual	20%	HP-IB, guarded, Statistics, Pass/Fail, Offset, % error	\$3.700
3497A 3 1/2, 4 1/2, 5 1/2 digit p 48	<ul style="list-style-type: none"> Selectable # of digits Built-in memory 	120 V	300 (50 with 5 1/2 digits)	0.1 V to 100 V	1 μV	±(.002% Rdg. + 1 count)		Program. current source for ohms					Auto/Manual	20%	HP-IB, Guarded Built-in mem. Program. current source	3497 Opt 001 \$2.750

DIGITAL VOLTMETERS

Voltmeter Accessories

Probes, Dividers, Carrying Cases

10007B Straight-thru probe

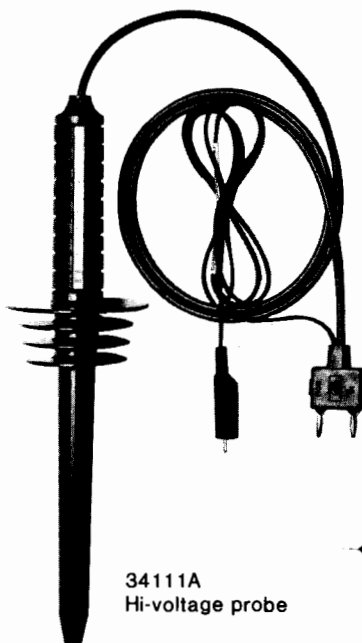
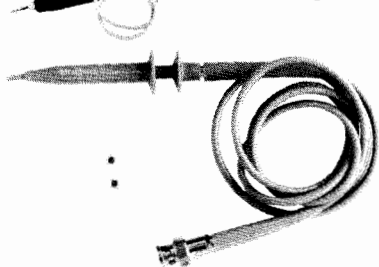

34111A
Hi-voltage probe

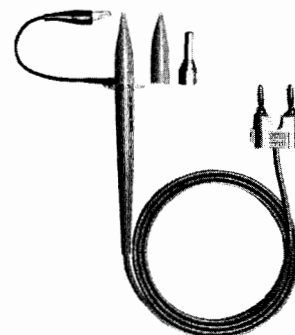

11096B
High frequency probe



34110A Soft vinyl carrying case

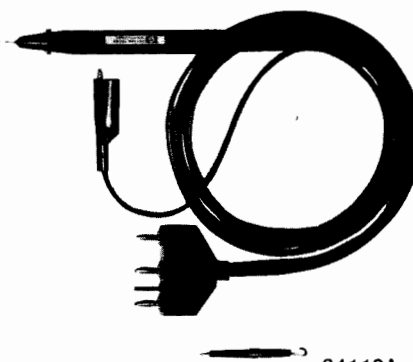

34112A
Touch-hold probe

10007B, 10008B Probe

The 10007B and 10008B are straight-thru BNC probes with a retractable hook tip and 20 cm (8 in.) ground lead with alligator tip.

	Peak Voltage	Shunt Capacitance	Length
10007B	600 V	40 pF	1.1 m (3.5 ft.)
10008B	600 V	60 pF	1.8 m (6 ft.)

11068A

Soft carrying case for 3476A and B DMM. Has shoulder strap and zippered opening for instrument and accessory pouch.

11096B High Frequency Probe

Converts dc voltmeter with 10 M Ω input to high-frequency ac voltmeter. Works with any dc voltmeter with 10 M Ω input impedance.

11096B Specifications

Voltage range: 0.25 to 30 V rms.

Transfer accuracy (when used with 10 M Ω \pm 10% dc voltmeter)

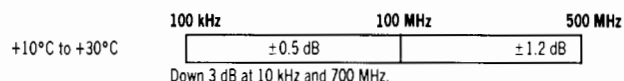

Response: peak responding. Calibrated to read rms value of sine wave.

Input impedance: 4 M Ω shunted by 2 pF.

Maximum input: 30 V rms ac; 200 V dc.

Cable length: 4' long (1219 mm).

Accessories furnished: High-Frequency Adapter; Straight tip; Hook Tip; Ground Lead.

Accessories available: HP 10218A BNC Adapter; HP 10219A Type 874 Adapter; HP 11063A 50 Ω Tee.

34110A

Carrying case for 1/2 rack size instruments. Inside dimensions of 25.4 cm x 22.9 cm x 10.2 cm or 10" deep x 9" wide x 4" thick. Zipper flip top lid and zippered accessory pouch. Has shoulder carrying strap.

34111A DC Hi-Voltage Probe

1000:1 divider will accept up to 40 kV. Input Z = 10 Ω . Divider accuracy meets specifications when connected to 10 M Ω input resistance instrument.

Division ratio accuracy:

0-20 kV	<4%	Divider has interchangeable hook and pointed tip.
30-40 kV		
20-30 kV	<2%	

34112A Touch-Hold Probe

Allows user to hold DMM display by depressing button on probe body. Both AC and DC voltage up to 1200 V max. DC or AC RMS may be measured and held. Usable on the 3435A, 3438A, 3465A/B, and 3466A.

Ordering Information

10007B Probe	\$50
10008B Probe	\$50
11068A Soft Carrying Case for 3476A and B DMM	\$30
11096B High Frequency Probe	\$120
34110A Carrying Case for 1/2 Rack Size Instruments	\$40
34111A DC Hi-Voltage Probe	\$150
34112A Touch-Hold Probe	\$65

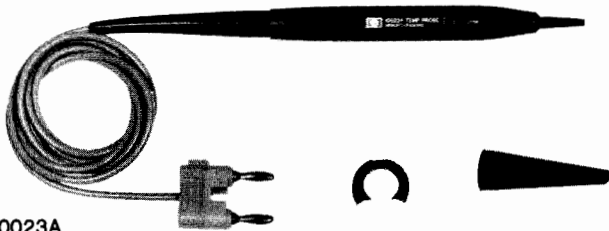

10023A

10023A Temperature Probe

The Model 10023A Temperature Probe provides the fast, accurate temperature measurements needed in a wide variety of thermal design, diagnostic, and testing applications. Surface temperature measurements are read directly in degrees Celsius on general purpose digital multimeters having an input impedance of ≥ 10 megohms. A pencil-like probe tip easily accesses small components and a press-to-read switch makes measurements easy.

The probe is a self-contained temperature-to-voltage transducer with a forward-biased diode chip providing calibrated linear output of $1 \text{ mV}/^\circ\text{C}$. The entire electronics assembly, including integrated circuits and battery is packaged in the probe barrel.

A standard dual banana plug output connector provides universal connection to digital voltmeters.

10023A Specifications

Electrical

Measurement range: -55°C to $+150^\circ\text{C}$.

Output: $1 \text{ mV}/^\circ\text{C}$.

Short term repeatability: $\pm 0.3^\circ\text{C}$ (minimum of 48 hrs).

Accuracy: $\pm 2^\circ\text{C}$ from 0°C to 100°C , decreasing linearly to $+2^\circ\text{C}$, -4°C at -55°C and $+4^\circ\text{C}$, -2°C at $+150^\circ\text{C}$.

Maximum voltage at tip: 600 V (dc + peak ac).

Tip capacitance to ground: approx 0.5 pF .

Thermal response: $< 3\text{s}$ to settle within 2°C of final reading (liquid measurement) for a 100°C temperature change.

DMM Input R: $\geq 10 \text{ M}\Omega$.

General

Operating environment (probe tip to approx 13 mm (0.5 in.) from probe tip): temperature, -55°C to $+150^\circ\text{C}$; altitude, to 4600 m (15 000 ft); vibration, vibrated in three planes for 15 min. each with 0.38 mm (0.015 in.) excursion, 10 to 55 Hz.

Operating environment (probe body): temperature, 0°C to 60°C (battery limitation); humidity (non-condensing), to 95% relative humidity at $+40^\circ\text{C}$, altitude and vibration same as those for probe tip.

Overall length: approx 1.4 m (53 in.).

Weight: net, 85 g (3 oz); shipping, 312 g (11 oz).

Battery life: approx 50 hr (varies with ambient temperature).

Low Battery indication: probe output indicates approx -70°C on DMM. First indication of a low battery condition is a decreasing indication of 1° to $2^\circ\text{C}/\text{minute}$ with probe tip at a constant temperature.

Accessories supplied: one replacement battery (1420-0256), one sliding lock collar (10023-23201), and one probe tip cover (00547-40005).

Replacement batteries: batteries may be purchased locally using the following part numbers, RAY-O-VAC^{®1}, RS 312-G or T-312-G; DURACELL^{®2} 10L125; or batteries with similar specifications.

^{®1}RAY-O-VAC is registered trademark of ESB, Inc.

^{®2}DURACELL is a registered trademark of P. R. Mallory & Co.

Ordering Information

10023A Temperature Probe

10023-60001 Replacement Tip, includes pre-calibrated tip and matching compensation network

Price

\$150

\$75

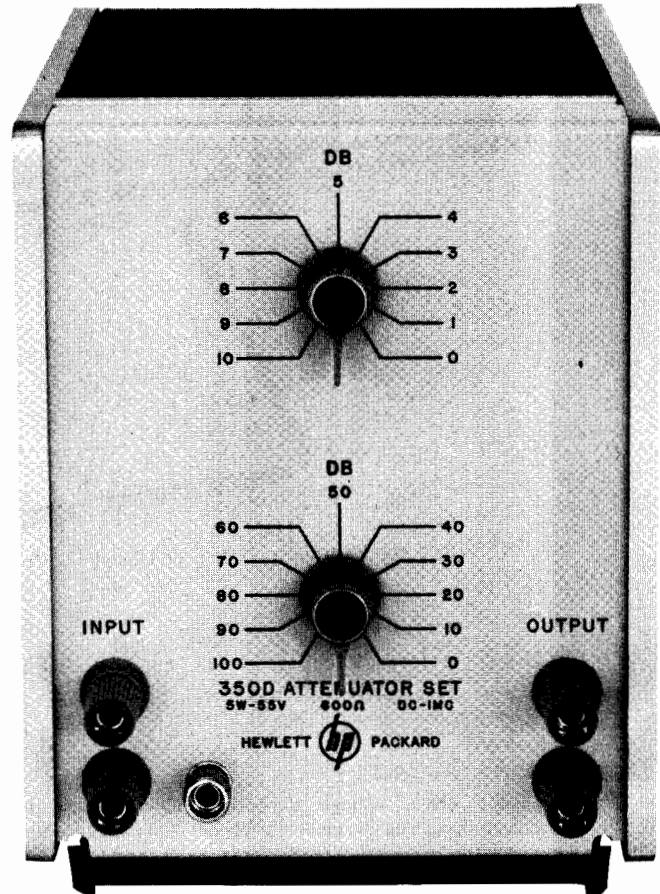

350D

350D Description

Two 600Ω unbalanced attenuator sections make up the Hewlett-Packard 350D Attenuator. One section is a 100 dB attenuator, adjustable in 10 dB steps. The other is a 10 dB attenuator, adjustable in 1 dB step.

350D Specifications

Attenuation: 0 to 110 dB, 1 dB and 10 dB steps.

Power capacity: 5 W (55 Vdc or rms) max, continuous duty.

DC isolation: signal ground may be $\pm 500 \text{ Vdc}$ from chassis.

Accuracy: dB at any step listed below.

10 dB Section

100 dB Section

	0 dB	10 dB	70 dB	100 dB
dc to 100 kHz	$< \pm 0.125$	$< \pm 0.25$	$< \pm 0.5$	$< \pm 0.5$
100 kHz to 1 MHz	$< \pm 0.25$	$< \pm 0.5$	$< \pm 0.5$	$< \pm 0.75$

Size: standard HP $\frac{1}{3}$ module (system I) $159 \text{ mm H} \times 130 \text{ mm W} \times 203 \text{ mm D}$ ($6\frac{1}{4}'' \times 5\frac{1}{8}'' \times 8''$).

Weight: net, 1.8 kg (4 lb.). Shipping, 2.7 kg (6 lb.).

Ordering Information

461A Amplifier
465A Amplifier
467A Power Amplifier/Supply
350D Attenuator

Price

\$600

\$500

\$1325

\$400

DIGITAL VOLTMETERS

Low-Cost Autoranging 3½ Digit DMM

Model 3476A/B

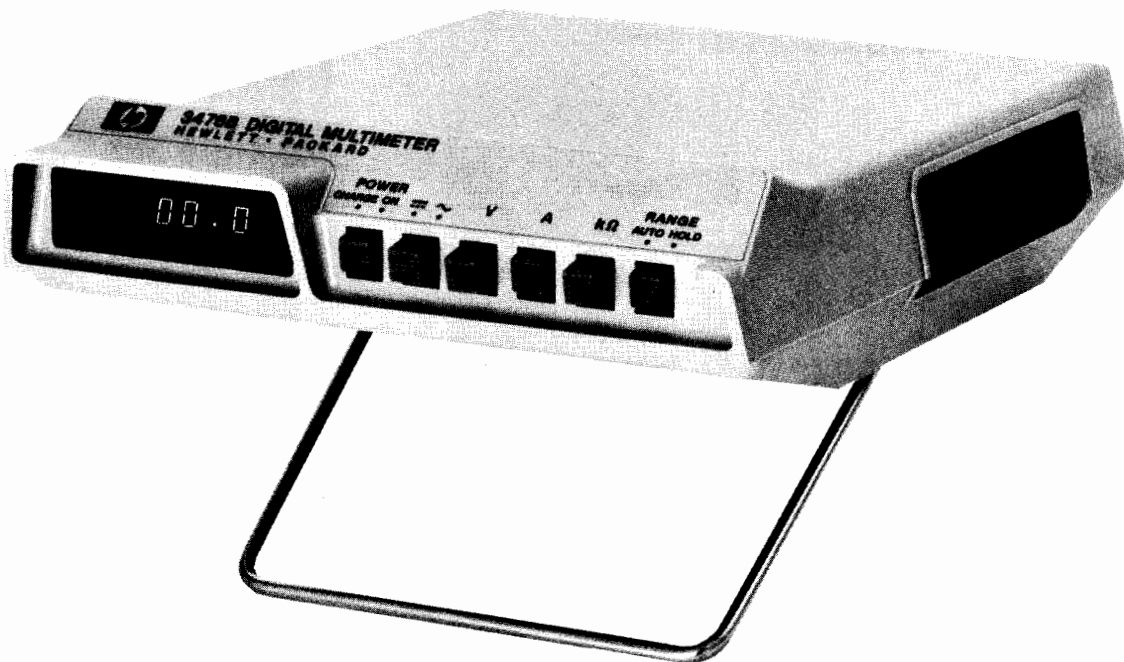

Description

If you measure current, voltage or resistance, you can use the 3476A/B to make these measurements faster and with fewer reading errors. This versatile instrument incorporates autorange to let you concentrate on your measurement, not the range or range multiplier. With autorange, readings always have the same multiplier: voltage always in volts, current in amps, and resistance in kilohms. In addition to autorange the 3476A/B has auto-zero and auto-polarity. Auto-zero eliminates the need to zero the instrument prior to a test, and auto-polarity lets you measure both positive and negative voltages without the inconvenience of reversing test leads.

The 3476A/B saves you time by combining the five most common measurements in one instrument. It measures AC voltage, DC voltage, AC current, DC current and resistance. In addition to these five basic measurements, the 3476A/B has additional features to save you time and effort. For example, there are two units to choose from. The lower cost 3476A operates on AC for your bench measurements. The 3476B will operate on either AC or nickel-cadmium batteries. Under battery operation you can break ground loops resulting in quieter readings or make measurements in remote locations. The 3476B will give you eight hours of continuous service before a recharge is required. Keep it plugged in and it will charge overnight and be ready for your next trip.

Convenience

An instrument designed to make your most common measurements should be convenient to use. The 3476A/B was designed to be convenient. An example is the replacement of the input protection fuses. Replacement is easy—no disassembly or re-calibration is necessary—simply slide back the input terminal cover plate to expose the defective fuse. Convenience means attention to design detail. A multiposition bail allows convenient positioning. There is even a vertical detent for viewing from above. Another convenient detail is the shape of the case. Small instruments with pushbuttons have trouble staying put when the buttons are pressed. The 3476A/B solves this problem with a finger grip ridge allowing one-handed operation.

3476A/B specifications

DC Voltmeter

Ranges:	0.1100V	Maximum display:	±0.1098 V
	1.100 V		±1.098V
	11.00 V		±10.98 V
	110.0 V		±109.8 V
	1100 V		±1000 V

Maximum input: 1000 V (DC + Peak AC).

Accuracy: (20°C to 30°C)*

Range	Accuracy
0.1100 V	±(0.3% of reading + 2 counts)
1.100 V 11.00 V	±(0.3% of reading + 1 count)
110.0 V 1100 V	±(0.4% of reading + 1 count)

*90 day cal. cycle. Add (0.2% of reading) for one year cal. cycle.

Common mode rejection: (1 kΩ unbalance) > 100 dB @ 50 Hz, 60 Hz.

Input resistance: 10 MΩ ± 5%.

Input protection: < 1100 V peak.

Temperature coefficient: ±(0.05% of reading + 0.2 count)/°C.

AC Voltmeter

Ranges:	0.1100 V	Maximum display:	0.1098 V
	1.100 V		1.098 V
	11.00 V		10.98 V
	110.0 V		109.8 V
	1100 V		700 V

Maximum input: 700 V rms.

Accuracy: converter is average responding calibrated in rms (20°C to 30°C)*

Ranges**	45 Hz to 2 kHz	2 kHz to 5 kHz	5 kHz to 10 kHz
1.100 V to 1100 V	±(1.5% of reading + 4 counts)	±(3% of reading + 6 counts)	±(8% of reading + 10 counts)
0.1100 V	±(2% of reading + 6 counts)	±(5% of reading + 6 counts)	±(18% of reading + 10 counts)

*90 day cal. cycle. Add (0.2% of reading + 1 count) for one year cal. cycle

**Ranges usable from 3% of range to full scale.



Common mode rejection: (1 k Ω unbalance) > 80 dB @ 50 Hz, 60 Hz.

Input resistance: 10 M Ω \pm 5%.

Input capacitance: < 30 pf.

Input protection: < 1100 V peak.

Temperature coefficient: \pm (0.05% of reading + 0.5 count)/ $^{\circ}$ C.

DC Ammeter

Ranges: 0.110 A **Max. display:** \pm 0.109 A
1.100 A \pm 1.098 A

Accuracy: (20 $^{\circ}$ C to 30 $^{\circ}$ C) \pm (0.8% of reading + 2 counts).*

Impedance: 1–1.5 ohm constant.

Current protected: 1.5 A fuse.

Temperature coefficient: \pm (0.05% of reading + 0.2 count)/ $^{\circ}$ C.

*90 day cal. cycle. Add (0.2% of reading) for one year cal. cycle.

AC Ammeter

Ranges: 0.110 A **Max. display:** 0.109 A
1.100 A 1.098 A

Accuracy: (20 $^{\circ}$ C to 30 $^{\circ}$ C)*

Ranges**	45 Hz to 2 kHz	2 kHz to 5 kHz
1.100 A	\pm (2% of reading + 4 counts)	\pm (3.5% of reading + 6 counts)
0.110 A	\pm (2.5% of reading + 6 counts)	\pm (5.5% of reading + 6 counts)

*90 day cal. cycle. Add (0.2% of reading + 1 count) for one year cal. cycle.

**Ranges usable from 3% of range to full range

Impedance: 1–1.5 ohm constant.

Current protected: 1.5 A fuse.

Temperature coefficient: \pm (0.05% of reading + 0.5 count)/ $^{\circ}$ C.

Ohmmeter

Ranges: 1.100 k Ω **Max. display:** 1.098 k Ω
11.00 k Ω 10.98 k Ω
110.0 k Ω 109.8 k Ω
1100 k Ω 1098 k Ω
11000 k Ω 10980 k Ω

Accuracy: (20 $^{\circ}$ C to 30 $^{\circ}$ C)*

Ranges	Accuracy
110.0 k Ω , 1100 k Ω	\pm (0.3% of reading + 1 count)
11000 k Ω , 1.100 k Ω 11 k Ω	\pm (0.5% of reading + 1 count)

*90 day cal. cycle. Add (0.2% of reading) for one year cal. cycle.

Open circuit voltage: < 4 V.

Input voltage protection: < 30 V rms continuous, fuse protected from 30 V to 250 V rms.

Temperature coefficient: \pm (0.05% of reading + 0.2 count)/ $^{\circ}$ C.

General

Ranging: Automatic, Range Hold.

Common to ground: < 500 V (peak).

Sample rate: \approx 3/second.

Overload indication: horizontal bars.

Operating environmental conditions

Temperature range: 0 $^{\circ}$ C to 55 $^{\circ}$ C (3476A); 0 $^{\circ}$ C to 40 $^{\circ}$ C (3476B).

Humidity: < 95% RH at 40 $^{\circ}$ C.

Power: 3476A AC line, 3476B AC line and batteries, < 6 VA

Standard, 104–127 V ac; 54–66 Hz

Option 001, 86–106 V ac; 54–66 Hz

Option 002, 86–106 V ac; 48–54 Hz

Option 003, 190–230 V ac; 48–54 Hz

Option 004, 208–250 V ac; 48–54 Hz

Option 006, 208–250 V ac; 54–66 Hz

Note: No charge for options 001 through 004 and 006. Power options may be changed in field by re-arranging jumpers. See manual for details.

Batteries: 4 rechargeable Nickel Cadmium Sub C size. Typical continuous operating time using fully charged batteries: 8 hours at 25 $^{\circ}$ C. Typical battery charging time: 14 hours at 25 $^{\circ}$ C with instrument turned off. Trickle charge with instrument on.

Weight: 3476A — net, 0.77 kg (1.7 lb); shipping, 1.68 kg (3.7 lb)
3476B — net, 0.97 kg (2.13 lb); shipping, 1.88 kg (4.13 lb).

Size: 3476A/B: 58 H x 168 W x 206 mm D (2.3" x 6.6" x 8.1").

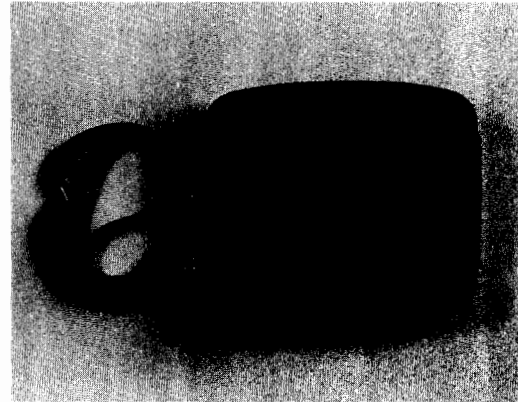

11068 A

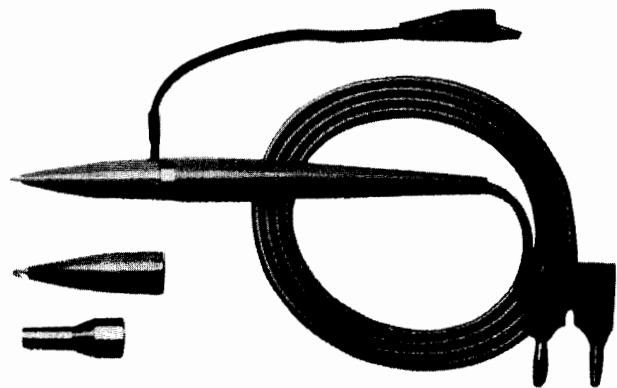

11096 B

Accessories

11096B RF probe 10 kHz to 700 MHz (with adaptors) \$120

11068A Soft Carrying Case \$30

34111A High-voltage probe 40 kV DC. \$150

10023A Temperature Probe \$150

Ordering Information

Opt 005 3476A/B, Test Lead Kit, and Soft Carrying Case add \$40

3476A Digital Voltmeter (includes pair of test leads) \$300

3476B Digital Voltmeter (includes pair of test leads) \$350

DIGITAL VOLTMETERS

3½ Digit, High Accuracy DMM
Model 3435A

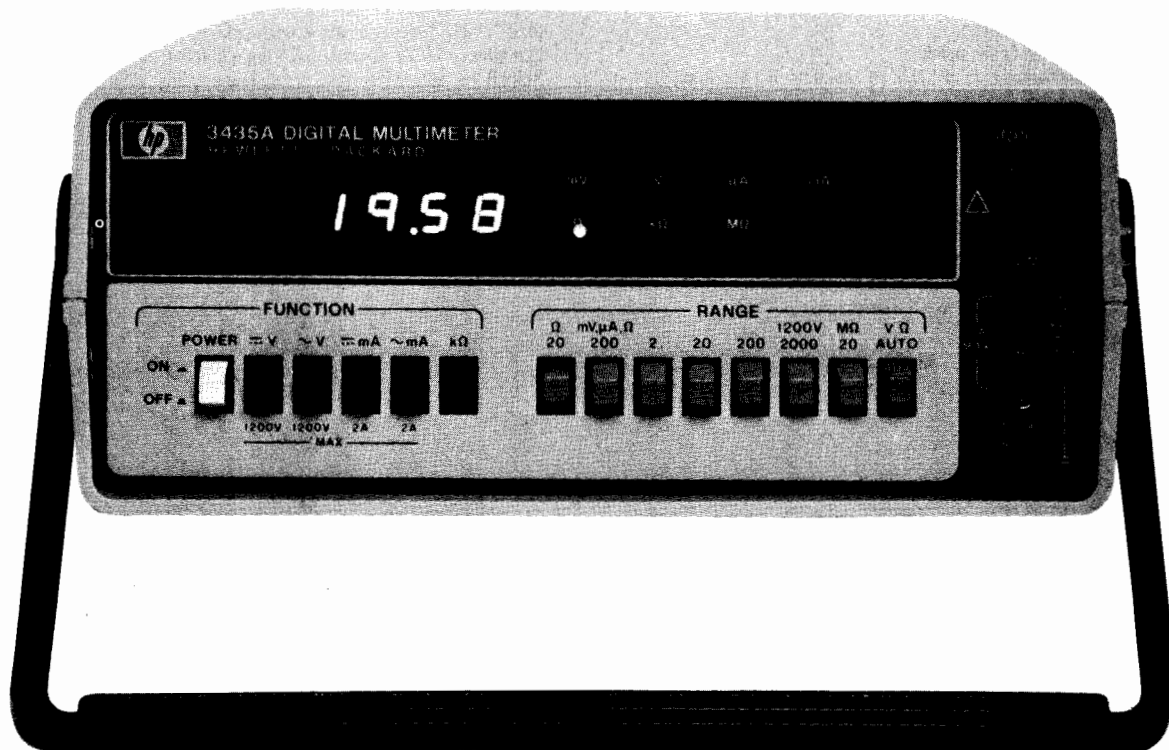

Description

The 3435A is a 3½ digit multimeter providing five functions of ACV, DCV, ACI, DCI and Ω. It is available with rechargeable batteries or AC line power only. The 34112A Touch-Hold probe provides "eyes-on" probing of AC and DC voltages by holding the 3435A display using a button on the probe. The 3435A case is rugged with a detent position carrying handle which is used also as a tilt stand.

Specifications

DC Voltmeter

Ranges:	Maximum display:
200 mV	± 199.9 mV
2 V	± 1.999 V
20 V	± 19.99 V
200 V	± 199.9 V
1200 V	± 1199 V

Maximum input: 1200 V (DC + Peak AC).

Ranging: automatic or manual.

Sensitivity: 100 μV on 200 mV range.

Polarity: automatically sensed and displayed.

Accuracy: 1 year, 15 to 30°C.

Range	Specifications
200 mV	±(0.1% of reading + 2 counts)
2 V to 1200 V	±(0.1% of reading + 1 count).

Temperature coefficient: (0 to 15°C and 30 to 55°C) ±(0.015% of reading + 0.1 count)/°C.

Input resistance: 10 MΩ ± 1%.

Input type: floating, 500 V maximum com. to ground.

Normal mode rejection: >40 dB at 50 Hz/60 Hz ±0.1 %.

Response time: <0.7 second to within 1 count of final value on one range. Add 1 second for each range change.

Effective common mode rejection: (1 kΩ unbalance) >120 dB at 50/60 Hz ±0.1%.

DC Current

Ranges:	Maximum display:
200 μA	± 199.9 μA
2 mA	± 1.999 mA
20 mA	± 19.99 mA
200 mA	± 199.9 mA
2000 mA	± 1999 mA

Maximum input: current: 2 amp (fuse protected). Voltage: 250 V.

Ranging: manual only.

Sensitivity: 100 nA on 200 μA range.

Polarity: automatically sensed and displayed.

Accuracy: 1 year, 15 to 30°C.

Range	Specifications
200 μA to 200 mA	±(0.3% of reading + 2 counts)
2000 mA	±(0.6% of reading + 2 counts)

Temperature coefficient: (0 to 15°C and 30 to 55°C) ±(0.028% of reading + 0.1 count)/°C.

Voltage Burden

Range	Maximum Burden at Full Scale
200 μA to 20 mA	<220 mV
200 mA	<240 mV
2000 mA	<400 mV

Response time: <0.7 second on any range to within 1 count of final value.

AC Voltmeter

AC converter: avg. responding rms calibrated.

Ranges:	Maximum display:
200 mV	199.9 mV
2 V	1.999 V
20 V	19.99 V
200 V	199.9 V
1200 V	1199 V

Maximum input: 1700 V (DC + Peak AC), 10⁷ volt-Hz max.
Ranging: automatic or manual.
Sensitivity: 100 μV on 200 mV range.
Accuracy: (with display of ≥20 counts) 1 year, 15 to 30°C.

Range	Specification
30 Hz-50 Hz	±(1.5% of reading +3 counts)
50 Hz-20 kHz	±(0.3% of reading +3 counts)
20 kHz-100 kHz	±(1.5% of reading +10 counts)

Temperature coefficient: (0 to 15°C and 30 to 55°C) ±(0.04% of reading +0.2 count)/°C.
Input impedance: resistance: 5 MΩ. Shunt capacitance: <50 pF.
Response time: <1.6 seconds to within 3 counts of final value on one range. Add 1.2 seconds for each range change.
Input type: floating, 500 V maximum com. to ground.

AC Current

Ranges:	200 μA	Maximum display:	199.9 μA
	2 mA		1.999 mA
	20 mA		19.99 mA
	200 mA		199.9 mA
	2000 mA		1999 mA

Maximum input: current: 2 amp (fuse protected). Voltage: 250 V.
Ranging: manual only.
Sensitivity: 100 nA on 200 μA range.
Accuracy: (with display of ≥20 counts)—1 year, 15 to 30°C.

Current Range	30 Hz		50 Hz		10 kHz	
	2000 mA	±(2% of reading +5 counts)	200 mA	±(1.7% of reading +5 counts)	200 μA	±(0.9% of reading +5 counts)

Temperature coefficient: (0 to 15°C and 30 to 55°C) ±(0.05% of reading +0.2 count)/°C
Voltage burden

Range	Maximum Burden at Full Scale
200 μA to 20 mA	<220 mV rms
200 mA range	<240 mV rms
2000 mA range	<400 mV rms

Response time: <1.6 seconds on any range to within 3 counts of final value.
Input type: floating, 500 V maximum com. to ground.

Ohmmeter

Ranges:	20Ω	Maximum display:	19.99Ω
	200Ω		199.9Ω
	2 kΩ		1.999 kΩ
	20 kΩ		19.99 kΩ
	200 kΩ		199.9 kΩ
	2000 kΩ		1999 kΩ
	20 MΩ		19.99 MΩ

Input protection: 250 V rms.
Ranging: automatic or manual.
Sensitivity: 10 milliohm on 20Ω range.
Accuracy: 1 year, 15 to 30°C.

Range	Specifications
20Ω	±(0.5% of reading +12 counts)
200Ω-2000 kΩ	±(0.2% of reading + 2 counts)
20 MΩ	±(0.8% of reading + 2 counts)

Temperature coefficient: (0 to 15°C and 30 to 55°C)

Range	Specifications
20Ω-2000 kΩ	±(0.04% of reading +0.2 count)/°C
20 MΩ	±(0.18% of reading +0.2 count)/°C

Configuration: 2 wire.
Open circuit voltage: <5 V.
Current through unknown

Range	20Ω	200Ω	2 kΩ	20 kΩ	200 kΩ	2000 kΩ	20 MΩ
Current	5 mA	5 mA	500 μA	50 μA	5 μA	500 nA	50 nA

Response time: <0.8 second to within 1 count. Add 0.8 second for each range change.

General

Calibration: data sheet specifications guaranteed for 1 year.
Display: 7 segment red 0.3 inch high LED's. Function and range annunciation.
Reading rate: 2.4 – 4.7/s depending on input level.
A-D conversion: dual slope.
Integration time: 100 ms.
Ranging: automatic or manual on ACV, DCV and ohms. Manual only on AC & DC current.
Storage temperature: AC line power only, -40 to +75°C; with batteries, -40 to +65°C.
Operating temperature: 0 to 55°C.
Humidity: 95% RH, +15 to +40°C.
Power: AC line: 48-440 Hz; 86-250 V (see Ordering Information). Battery: rechargeable lead-acid 10 hours minimum continuous operation with full charge. Recharge time: 16 hours operating, 12 hours nonoperating. Batteries and charger available separately; consult operating manual. Total instrument power dissipated: AC only; 3 watts; with charger; 8 watts.

Size:

	3435A	3435A Option 002
	23.81 cm (9.4") wide	20.96 cm (8.25") wide
	9.84 cm (3.9") high	8.57 cm (3.4") high
	27.62 cm (10.9") long	26.67 cm (10.5") long

Weights: 3435A 2.41 kg (5.3 lb.)
 3435A Opt. 001 1.84 kg (4.1 lb)
 3435A Opt. 002 1.81 kg (4 lb)

Accessories Furnished: 2 test probes

Accessories	Price
11000A Test leads, dual banana both ends.	\$20
11002A Test leads, dual banana to dual alligator.	\$17
11003A Test leads, dual banana to probe and alligator.	\$15
11096B RF Probe, 10 kHz to 700 MHz.	\$120
34110A Soft vinyl carrying/operating case.	\$40
34111A High-voltage probe 40 kV DC.	\$150
34112A Touch-Hold Probe.	\$55
5061-0072 ½ Module rack mount kit. (Available on Opt 002 only).	\$35
10023A Temperature Probe	\$150

Ordering Information

3435A streamlined portable case with handle, AC line power. Batteries and charger included. \$525
 3435A Opt. 001, streamlined portable case, AC line power only. less \$65
 3435A Opt. 002, Rack and Stack case, AC line power only. (Rack mount kit not included.) less \$35
 All orders must include one of the power options: 86–106 V Opt. 100; 190–233 V Opt. 210; 104–127 V Opt. 115; 208–250 V Opt. 230. N/C

DIGITAL VOLTMETERS

1 μ V Sensitivity, 4½-Digit, 5-Function Multimeter

Models 3465A/B Digital Multimeters



3465A

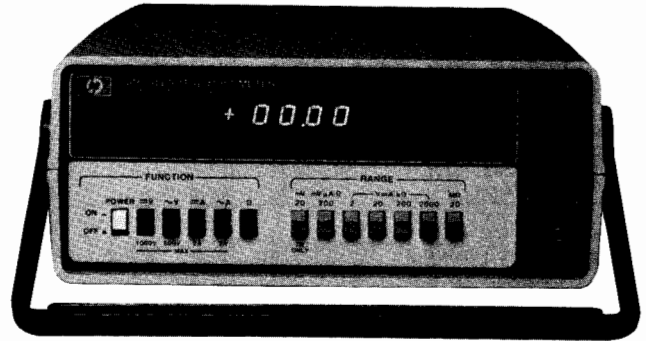

3465B

Description

The 3465A and B are 4½ digit multimeters providing five functions of ACV, DCV, ACI, DCI and Ω . They feature both portability and bench applications by offering a choice of line and battery power options. The 3465A is offered in the half-module rack and stack case. The 3465B is offered in the rugged streamlined synthetic case with a carrying handle. Both units accept the 34112A touch-hold probe for "eyes-on" measurements of AC and DC voltage.

Specifications

DC Voltmeter

Ranges: 20.000 mV **Maximum display:** ± 19.999
 200.00 mV ± 199.99
 2.0000 V ± 1.9999
 20.000 V ± 19.999
 200.00 V ± 199.99
 1000.0 V ± 1000.0

Maximum input: 1000 VDC and peak AC.

Sensitivity: 1 microvolt on lowest range.

Polarity: automatically sensed and displayed.

Accuracy: (1 year, 23°C $\pm 5^\circ$ C)

Range	Specifications
20 mV	$\pm (0.03 \text{ of reading} + 2 \text{ counts})$
thru 200 V	$\pm (0.02\% \text{ of reading} + 1 \text{ count})$
1000 V	$\pm (0.025\% \text{ of reading} + 1 \text{ count})$

Temperature coefficient: (0°C to 50°C) $\pm 0.003\%$ of reading/ $^\circ$ C.

Input resistance:

Range	Specifications
20 mV thru 2 V	$\geq 10^9 \Omega$
20V thru 1000 V	10 M $\Omega \pm 1\%$

Normal mode rejection: $> 60 \text{ dB}$ at 50/60 Hz $\pm 0.1\%$.

Effective common mode rejection: (1 k Ω unbalanced) AC: $> 120 \text{ dB}$ at 50/60 Hz $\pm 0.1\%$.

DC Current

Ranges: 200.00 μ A **Maximum display:** ± 199.99
 2.0000 mA ± 1.9999
 20.000 mA ± 19.999
 200.00 mA ± 199.99
 2000.0 mA ± 1999.9

Maximum input: 2A from $< 250 \text{ V}$ source (fuse protected).

Sensitivity: 10 nA on lowest range.

Polarity: automatically sensed and displayed.

Accuracy: (1 year, 23°C $\pm 5^\circ$ C)

Range	Specifications
200 μ A, 2 mA	$\pm (0.07\% \text{ of reading} + 1 \text{ count})$
20 mA	$\pm (0.11\% \text{ of reading} + 1 \text{ count})$
200 mA, 2000 mA	$\pm (0.6\% \text{ of reading} + 1 \text{ count})$

Temperature coefficient: (0°C to 50°C)

Range	Specifications
200 μ A	$\pm 0.006\%$ of reading/ $^\circ$ C
2 mA, 20 mA	$\pm 0.004\%$ of reading/ $^\circ$ C
200 mA, 2000 mA	$\pm 0.01\%$ of reading/ $^\circ$ C

Voltage Burden

2000mA range: $< 700 \text{ mV}$ at full scale.

All other ranges: $< 250 \text{ mV}$ at full scale.

Ohmmeter

Ranges: 200.00 Ω **Maximum Display:** 19.999
 2.0000 k Ω 19.999
 20.000 k Ω 19.999
 200.00 k Ω 199.99
 2000.0 k Ω 1999.9
 20.000 M Ω 19.999

Protection: 350 V (DC + peak AC); 250 V rms.

Sensitivity: 10 milliohm on lowest range.

Accuracy: (1 year, 23°C $\pm 5^\circ$ C)

Range	Specifications
200 Ω	$\pm (0.02 \text{ of reading} + 2 \text{ counts})$
2 k Ω thru 2 M Ω	$\pm (0.02\% \text{ of reading} + 1 \text{ count})$
20 M Ω	$\pm (0.1\% \text{ of reading} + 1 \text{ count})$

Temperature coefficient: (0°C to 50°C)

Range	Specifications
200 Ω thru 2 M Ω	$\pm 0.0015\%$ of reading/ $^\circ$ C
20 M Ω	$\pm 0.004\%$ of reading/ $^\circ$ C

Configuration: 2 wire.

Open circuit voltage: <5 V max.
Current Through Unknown

Range	1
200Ω	1 mA
2 kΩ	1 mA
20 kΩ	10 μA
200 kΩ	10 μA
2000 kΩ	1 μA
20 MΩ	0.1 μA

AC Voltmeter

Ranges: 200.00 mV **Maximum display:** 199.99
 2.0000 V 1.9999
 20.000 V 19.999
 200.00 V 199.99
 500 V 500.00

Maximum input: full scale to 10 kHz decreasing linearly to 50% of full scale at 20 kHz; except on 500 V range, 2 kHz.

Overload protection: 600 V DC max.
 500 V AC rms
 800 V peak.

Sensitivity: 10 μV on lowest range.

Accuracy: converter is average responding calibrated to rms (1 year, + 23°C ± 5°C)

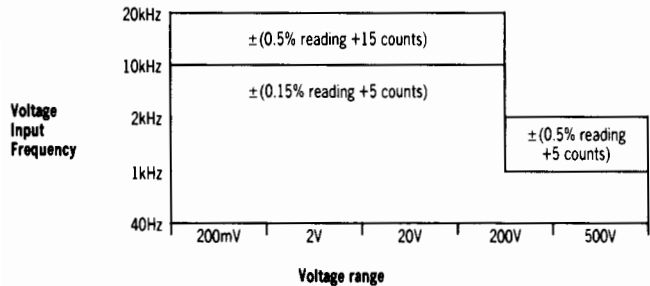

Temperature coefficient: (0°C to 50°C) ± (0.005% of reading + 0.2 count)°C.

Input impedance: resistance: 1 MΩ, <100 pF shunt.

AC Current

Ranges: 200.00 μA **Maximum display:** 199.99
 2.0000 mA 1.9999
 20.000 mA 19.999
 200.00 mA 199.99
 2000.0 mA 1999.9

Maximum input: 2 A from < 250 V source (fuse protected). Full scale to 10 kHz decreasing linearly to 50% of full scale at 20 kHz on lowest 4 ranges; 1 kHz max on 2000 mA range.

Sensitivity: 10 nA on lowest range.

Accuracy: (1 year, + 23°C ± 5°C)

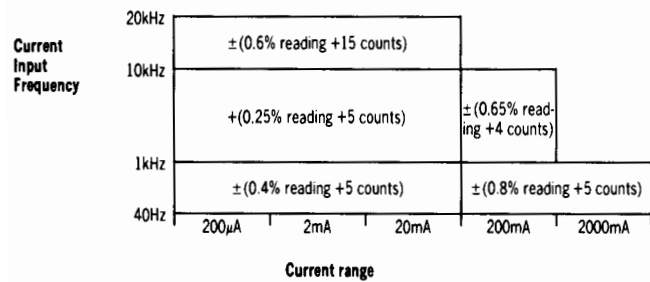

Temperature coefficient: (0°C to 50°C): ± 0.01% of reading /°C.

Voltage burden:

200 mA range: <700 mV FS.
 All other ranges: <250 mV FS.

General

Integration time: 100 ms.
Reading rate: 2½ readings per second.
Display: light-emitting diodes.

Overload indication: display blanks, except for overrange "1" and decimal point.

Humidity range: 95% RH at 40°C.

Operating temperature: 0°C to +55°C. (Nickel Cadmium Batteries 0°C to +40°C).

Storage temperature: -40°C to +75°C. (Nickel Cadmium Batteries -40°C to +40°C).

Size:

3465A 85.7 H × 209.6 W × 266.7 mm D (3.4" × 8.25" × 10.5")

3465B 98.4 H × 238.1 W × 276.2 mm D (3.9" × 9.4" × 10.9")

Weights: net, 2 kg (4.5 lbs). Shipping, 4.5 kg (10 lbs).

Accessories:

	Price
34112A Touch-hold Probe	\$65.00
34111A High Voltage Probe	\$150.00
The 34111A, 100 to 1 DC High Voltage Divider Probe, lets you measure up to 40,000 volts.	
11096B RF Probe	\$120.00
The 11096B RF Probe detects AC voltage up to 700 MHz.	
11000A Test Leads, dual banana both ends	\$20.00
11002A Test Leads, dual banana to dual alligator	\$17.00
11003A Test Leads, dual banana to probe and alligator	\$15.00
34110A Soft Vinyl Carrying/operating case	\$40.00
10023A Temperature Probe	\$150.00

For 3465A only:

5061-0072 Rack Mount Kit	\$35.00
82001B Nickel Cadmium battery pack (2 required)	ea. \$12.50
82002A Battery Eliminator (hand-held calculator charger)	\$20.00
1420-0024 Type "D" Alkaline cell in U.S.A. equal to U-2 in Europe (4 required)	ea. \$3.30

For 3465B only

82033A: Nickel Cadmium battery pack (1 required)	\$18.00
---	---------

Options:

Standard 3465A DVM \$600

Includes test leads, AC line power, batteries, and battery charger.

AC line: 87-127 V; 48-440 Hz or 176-250 V; 48-440 Hz (switch selectable)

Batteries: 2 rechargeable Nickel Cadmium packs (model 82001A) 6 hours continuous operation.

Opt 001: AC line power only. Batteries not included; battery charger is provided. AC line: 87-127 V; 48-440 Hz or 176-250 V; 48-440 Hz (switch selectable) less \$20.00

Opt 002: 4 type D Alkaline dry cells (U-2 cells in Europe). These non-rechargeable batteries provide 60 hours continuous use at 23°C. Includes receptacle to use 82002A battery eliminator which provides power from AC line (82002A not included) less \$100.00

Standard 3465B DMM

\$575.00

Includes test leads, AC line power, batteries, and battery charger.

AC line: One of the following no-charge power options must be specified for the 3465A:

Opt 100: 86-106 V AC; 48-440 Hz	N/C
Opt 115: 104-127 V AC; 48-440 Hz	N/C
Opt 210: 190-230 V AC; 48-440 Hz	N/C
Opt 230: 208-250 V AC; 48-440 Hz	N/C

Batteries: One rechargeable Nickel Cadmium battery pack (model 82033A) provides 6 hours continuous operation. Recharge time is 8 hours with instrument off. Trickle charge with instrument on.

Ordering Information (including test leads)

3465A DMM with 2 82001A's, AC line, batteries & charger	\$650.00
3465B DMM with battery, AC line, and charger	\$625.00



DIGITAL VOLTMETERS

4 1/2 Digit Autoranging DMM

Model 3466A

- 1 μ V dc sensitivity
- 1 milliohm sensitivity
- True-Rms (DC + AC)
- Diode Test

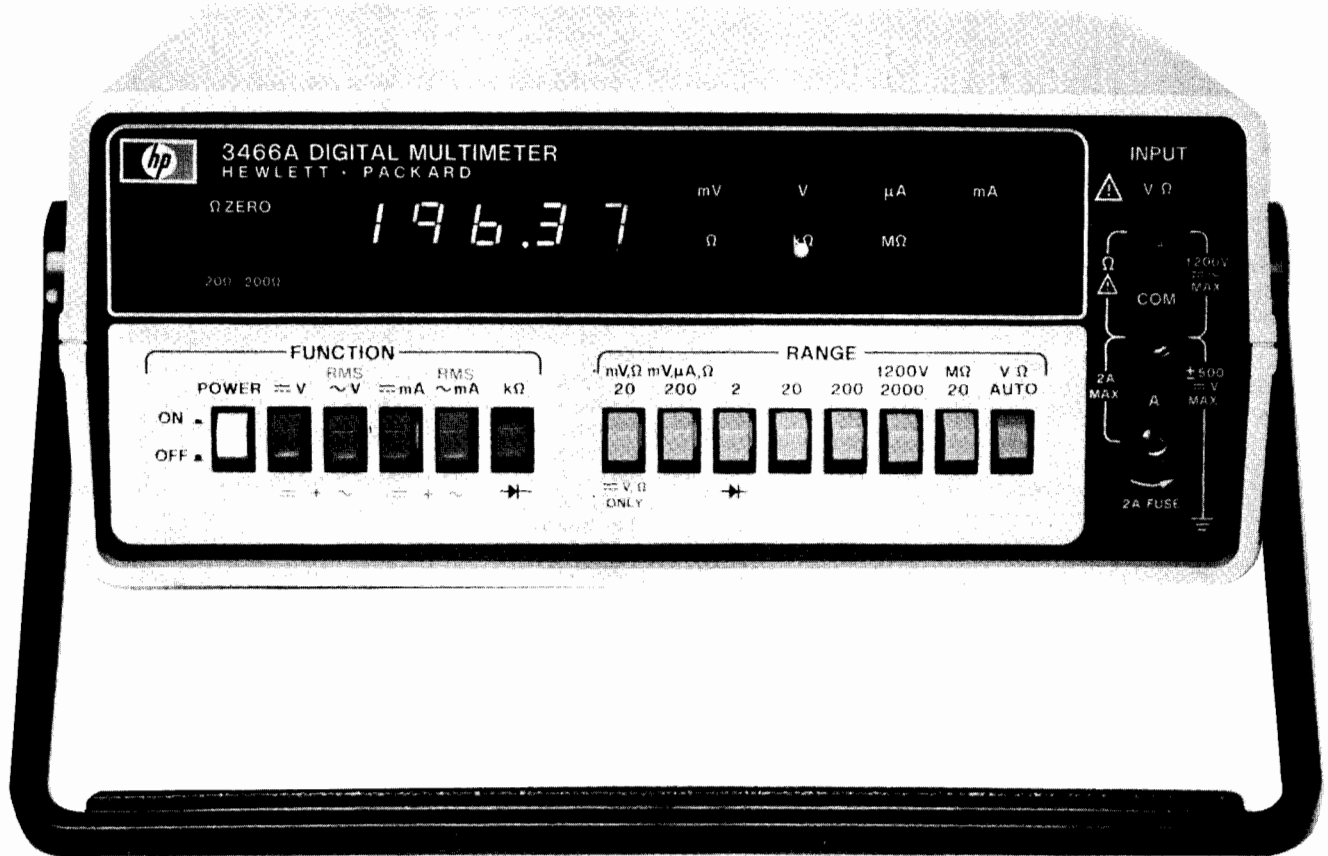

Description

The 3466A is a 4 1/2 digit Multimeter with autoranging volts and ohms. Functional capability includes ACV, DCV, (AC + DC) V, ACI, DCI, (AC + DC) I, Ω , and diode test. AC measurements are True-RMS with selectable AC or DC coupling. Available with rechargeable batteries or AC power only, it has 1 μ V DC and 1 m Ω sensitivity with zero adjustment on lowest ranges to compensate for external offsets.

Input resistance: 10 meg Ω \pm 0.5% all ranges.
Normal mode rejection: \geq 60 dB @ 50/60 Hz \pm 0.1%.
Effective common mode rejection (1 K Ω unbalance): \geq 120 dB @ 50/60 Hz \pm 0.1%; \geq 140 dB @ DC
Input type: floating, 500 V maximum common to ground.

Specifications

DC Voltmeter

Voltage Range	Maximum Display
20 mV	\pm 19.999 mV
200 mV	\pm 199.99 mV
2 V	\pm 1.9999 V
20 V	\pm 19.999 V
200 V	\pm 199.99 V
1200 V	\pm 1199.9 V

DC Current

Current Range	Maximum Display
200 μ A	\pm 199.99 μ A
2 mA	\pm 1.9999 mA
20 mA	\pm 19.999 mA
200 mA	\pm 199.99 mA
2000 mA	\pm 1999.9 mA

Maximum input: \pm 1200 V maximum DC and peak AC.
Ranging: automatic or manual.
Sensitivity: 1 μ V on 20 mV range.
Accuracy: (1 yr., 18 to 28°C assuming rear panel zero adjustment on lowest two ranges)

Maximum input: 2 amp from < 250 V source (fuse protected).
Ranging: manual only.
Sensitivity: 10 nA on 200 μ A range.
Accuracy (1 yr., 18 to 28°C):

Range	Specification \pm (% of reading + # of counts)
20 mV	(.05 + 3)
200 mV	(.04 + 2)
2 V — 200 V	(.03 + 1)
1200 V	(.035 + 1)

Range	Specification \pm (% reading + # of counts)
200 μ A through 20 mA	(.07 + 2)
200 mA	(0.15 + 2)
2000 mA	(0.5 + 2)

Input type: floating 500 V maximum Common to ground.

AC Voltmeter

AC Converter: True-RMS Responding True-RMS Calibrated

Range	Maximum Display
200 mV	199.99 mV
2 V	1.9999 V
20 V	19.999 V
200 V	199.99 V
1200 V	1199.9 V

Maximum input: (AC + DC): ± 1200 V DC; ± 1700 V (DC + Peak AC), 10^7 V \cdot Hz, AC: ± 600 V DC; 1700 V (Peak AC + DC), 10^7 V \cdot Hz.

Ranging: automatic or manual.

Sensitivity: 10 μ V on 200 mV range.

Crest factor: 4:1 at Full Scale.

Accuracy (with display of $\geq 10\%$ of range): 1 yr., 18 to 28°C sinusoidal waveform.

AC TRMS: (20 Hz to 100 kHz)

Frequency Range	Specification \pm (% of reading + # of counts)
20 Hz to 30 Hz	(2 + 50)
30 Hz to 50 Hz	(1 + 30)
50 Hz to 10 kHz	(0.3 + 20)
10 kHz to 20 kHz	(1 + 40)
20 kHz to 100 kHz	(2 + 150)

DC + AC TRMS: DC + (20 Hz to 100 kHz).
(Accuracy applies after 10 minute warmup)

DC + Frequency Range	Specification \pm (% of reading + # of counts)
DC, 20 Hz to 50 kHz	(1 + 80)
50 kHz to 100 kHz	(2 + 200)

Input impedance: resistance 2 M Ω , $\pm 1.5\%$.
Shunt capacitance <75 pF.

Input type: Floating, 500 V Maximum common to ground.

AC Current

Current Range	Maximum Display
200 μ A	199.99 μ A
2 mA	1.9999 mA
20 mA	19.999 mA
200 mA	199.99 mA
2000 mA	1999.9 mA

Detector: True RMS.

Crest factor: 4:1 at Full Scale

Maximum input: 2 Amp RMS from <250 V source (fuse protected).

Ranging: manual only.

Sensitivity: 10 nA on 200 μ A range.

Accuracy: (with display $\geq 10\%$ of range) 1 yr., 18°C to 28°C, sinusoidal waveform.

AC TRMS: 20 Hz to 10 kHz.

Range	Frequency	Specification \pm (% of reading + # of counts)
200 μ A–200 mA	20 Hz–30 Hz	2 + 50
	30 Hz–10 kHz	0.9 + 35
2000 mA	20 Hz–30 Hz	2 + 50
	30 Hz–10 kHz	1.2 + 20

(DC + AC) TRMS: DC + (20 Hz to 10 kHz).
(Accuracy applies after 10 minute warmup)

All ranges: 20 Hz to 10 kHz, \pm (1.5% of reading + 80 counts).
Input type: floating, 500 V maximum common to ground.

Ohms

Range	Maximum Display
20 Ω	19.999 Ω
200 Ω	199.99 Ω
2 k Ω	1.9999 k Ω
20 k Ω	19.999 k Ω
200 k Ω	199.99 k Ω
2000 k Ω	1999.9 k Ω
20 M Ω	19.999 M Ω

Accuracy: 1 yr., 18 to 28°C (assuming use of front panel zero on lowest two ranges).

Range	Specification \pm (% of reading + # of counts)
20 Ω –200 Ω	.08 + 2
2 k Ω –200 k Ω	.03 + 1
2000 k Ω	.04 + 1
20 M Ω	.15 + 1

Input protection: 250 V RMS or 350 V (DC + peak AC).

Ranging: automatic or manual.

Sensitivity: 1 milliohm on 20 ohm range.

Configuration: 2 wire.

Zero adjustment: range of 700 m Ω . Use on 20 Ω , and 200 Ω ranges.

Open circuit voltage: <5 V maximum.

Current through unknown:

Range:	20 Ω ,	200 Ω ,	2 k Ω ,	20 k Ω ,	200 k Ω ,	2000 k Ω ,	20 M Ω
Current:	5 mA,	5 mA,	1 mA,	100 μ A	10 μ A	1 μ A	100 nA

Diode Test

Function: $\rightarrow \leftarrow$ (k Ω).

Range: $\rightarrow \leftarrow$ (2k Ω).

Current source: 1 mA $\pm 1.5\%$.

Diode voltage drop displayed in volts: 1.9999 volts maximum.

Open circuit voltage: <5 volts maximum.

Overload protection: 350 V (DC + peak AC).

General

Display: 7 segments red 0.3 in high LED. Function and range annunciated.

Reading rate: 2.4 to 4.7/sec. depending on input level.

Remote trigger: shorting COM to A stops sampling in Volts functions.

Storage temperature: AC only, -55°C to $+75^\circ\text{C}$; with batteries, -55°C to $+65^\circ\text{C}$.

Operating temperature: (0 to 55) $^\circ\text{C}$.

Humidity: 95% RH at $+40^\circ\text{C}$.

Power: AC line; 48–440 Hz; 86–250 V.

Battery: rechargeable lead-acid 8 hours maximum continuous operation with full charge. Recharge time: 16 hours operating, 12 hours non-operating. Batteries and charger available separately, consult operating manual. Total power dissipated: AC only, 4 watts; with charger, 9 watts.

Size: 3466A: 98.4 mm H x 238.1 mm W x 276.2 mm D (3.88" x 9.38" x 10.88"). 3466A Opt. 002: 81 mm H x 215 mm W x 279 mm D (3.13" x 8.38" x 10.88")

Weight: 3466A: 2.9 kg (6.31 lb).

3466A Opt 001: 2 kg (4.41 lb).

3466A Opt. 002: 2.6 kg (5.73 lb).

Ordering Information

Configuration: 3466A streamlined portable case with handle, AC line power, batteries and charger included; 3466A Opt 001, eliminate battery and charger, AC line power only. Opt 002 Rack and Stack case, AC line power only (rack mount kit not included). All orders must include one of these line power options: Opt 100, 86–106 V; Opt 115, 104–127 V; Opt 210, 190–233 V; Opt 230, 208–250 V.

Options

Opt 001 less \$75

Opt 002 less 35

Opt 100, 115, 210, 230 N/C

3466A Digital Multimeter **\$775**

DIGITAL VOLTMETERS

4½ Digit Logging Multimeter

Model 3467A

- DC voltmeter, true-rms voltmeter, ohmmeter
- Digital thermometer
- Four channel scanner
- Math functions
- Printer & timer
- Diode test

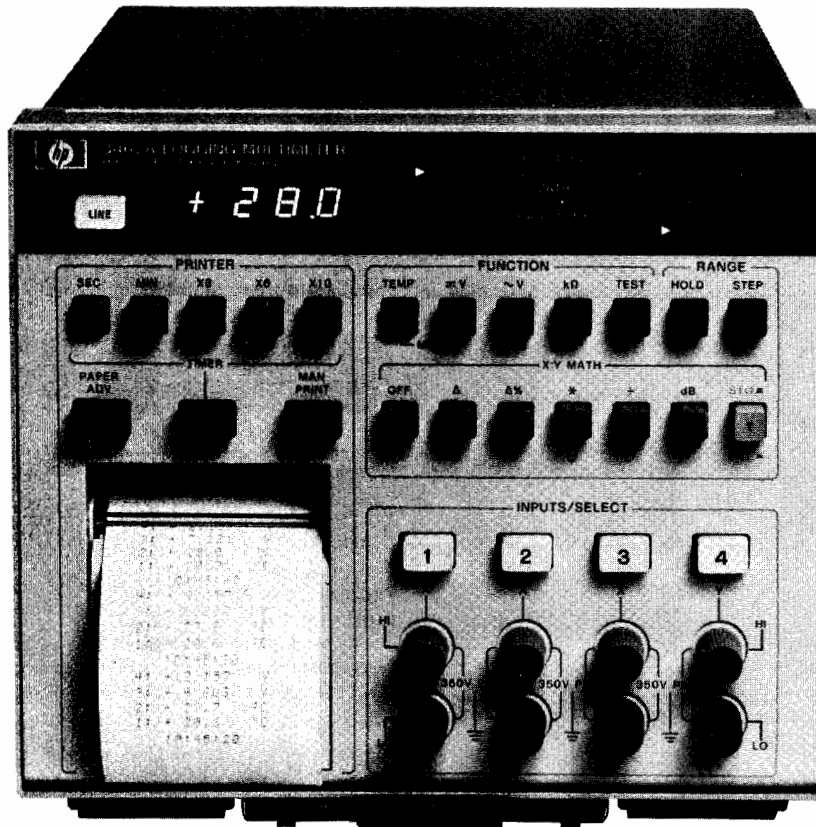

3467A

Description

Hewlett-Packard's 3467A Logging DMM is a total measurement station, doing jobs that used to require several instruments. The HP 3467A combines a high performance 4½ digit DMM, four channel scanner, digital thermometer, math functions, and printer with timer in a single instrument. It simplifies setups and measurements and gives you a record of data in the units you need (°C, dB, etc.) . . . unattended or manually.

The 3467A can be used to measure DC volts, resistance, true-rms AC volts, or temperature. Temperature can be measured simultaneously with voltage or resistance to allow convenient analysis of temperature dependent parameters. Using thermistors, the temperature measurements can be made directly in °C or °F. Other built-in math functions can be performed on the first three channels with respect to a measured input on the fourth channel or a manually entered constant.

Specifications

DC Voltmeter

Range	Maximum Reading
20mV	± 19.999mV
200mV	± 199.99mV
2V	± 1.9999V
20V	± 19.999V
200V	± 199.99V
350V	± 349.9V

Maximum input: ± 350 V from any terminal to ground and between any two terminals

Ranging: Automatic or Hold/Step

Sensitivity: 1 μV on 20 mV range

Polarity: Automatically sensed and displayed

Zero adjustment: Front panel pushbutton compensated for up to ± 2 mV offset for each channel

Accuracy: 6 months, 18°C to 28°C (Assuming 30 minute warmup and use of zero adjustment):

Range	± (% of Reading + Number of Counts)
20mV	0.05 + 10
200mV	0.04 + 2
2V - 200V, 350V	0.03 + 1

Temperature coefficient: (0° to 18°C, 28° to 50°C): ± (.003% of reading + 0.15 counts)/°C

Input resistance: 10 MΩ ± 5% on all ranges

Normal mode rejection: > 60 dB at 50/60 Hz ± 0.1%

Effective common mode rejection (1 KΩ unbalance): > 120 dB at 50/60 Hz ± 0.1%

Single channel response time (no print): < 0.7 seconds to within 1 count of final value on one range. Add 0.8 seconds for each range change.



Ohmmeter

Range	Maximum Reading	Current Through Unknown
200Ω	199.99Ω	5 mA
2KΩ	1.9999Ω	1 mA
20KΩ	19.999KΩ	100 μA
200KΩ	199.99KΩ	10 μA
2MΩ	1.9999MΩ	1 μA
20MΩ	19.999MΩ	100 nA

Input Protection: 250 V RMS or 350 V (DC + peak AC)

Ranging: Automatic or Hold/Step

Sensitivity: 10 mΩ on 200Ω range

Configuration: 2 wire with front panel pushbutton zero adjustment.

Lead resistance of up to 20Ω can be nulled out for each channel

Accuracy: 6 months, 18°C to 28°C (Assuming use of zero adjustment on 200Ω range):

Range	± (% of Reading + Number of Counts)
200Ω	0.08 + 10
2KΩ	0.03 + 3
20KΩ–200KΩ	0.03 + 1
2MΩ	0.04 + 1
20MΩ	0.15 + 1

Temperature coefficient: (0°C to 18°C, 28°C to 50°C)

Range	± (0.002% of reading + 1 count)/°C
200Ω	± (0.002% of reading + 1 count)/°C
2KΩ–2MΩ	± (0.002% of reading + 0.1 count)/°C
20MΩ	± (0.01% of reading + 0.1 count)/°C

Open circuit voltage: <5V

Single channel response time (no print): <1.1 seconds to within 1 count of final value on one range. Add 0.8 seconds for each range change.

Diode Test

Function: (kΩ) ←

Range: 2KΩ

Current source: 1mA ±4%

Diode voltage drop displayed in volts: 1.9999 volts maximum measurable voltage

AC Voltmeter

AC converter: True RMS Responding and calibrated in True RMS; AC coupled

Range	Maximum Reading
200mV	199.99mV
2V	1.9999V
20V	19.999V
200V	199.99V
250V	249.9V

Maximum input: ±350V (DC + peak AC), 10⁷ V·Hz from any terminal to ground and between any two terminals

Ranging: Automatic or Hold/Step

Sensitivity: 10 μV on 200 mV range

Crest factor: 4:1 at full scale

Accuracy: Accuracy applies with readings of ≥9% of full scale (≥1800 counts on 250 V range): 6 months, 18°C to 28°C; sinusoidal waveform

Frequency	± (% of Reading + Number of Counts)
45 Hz–100 Hz	1 + 40
100 Hz–10 kHz	0.2 + 40
10 kHz–20 kHz	1 + 40
20 kHz–100 kHz	2 + 200

Temperature coefficient: (0°C to 18°C, 28°C to 50°C)

Frequency	± (0.05% of reading + 2 counts)/°C
45 Hz–100 Hz	± (0.05% of reading + 2 counts)/°C
100 Hz–10 kHz	± (0.03% of reading + 2 counts)/°C
10 kHz–20 kHz	± (0.05% of reading + 2 counts)/°C
20 kHz–100 kHz	± (0.05% of reading + 15 counts)/°C

Input impedance: 2MΩ ± 5% in parallel with <100 pF

Single channel response time (no print): <2 seconds to within 4 counts of final value on one range. Add 1.2 seconds for each range change.

Temperature Measurement

Technique: Temperature measurements using thermistors can be made directly in °C or °F, selectable by an internal switch.

Thermistor linearization is included for the following thermistors: YSI 44007, OMEGA 44007, FENWAL UUA 35J1 or equivalent. (One thermistor is furnished with each 3467A).

Accuracy: The accuracy specification includes ohmmeter accuracy, thermistor curve fit accuracy, and thermistor self-heating:

–80°C to + 80°C:	±0.3°C
+80°C to +110°C:	±0.5°C
+110°C to +150°C:	±1.3°C

Four-Channel Scanner

Type: One 2-pole low thermal dry reed relay per channel.

Inputs: Floating inputs. Any combination of four channels may be selected to measure one of these functions: DC volts, True-RMS AC volts, resistance or temperature. Measurements of temperature on channels 1 and 2, and either DC volts, AC volts, or resistance on channels 3 and 4 can also be made.

Channel-to-Channel Isolation:

Source Impedance	Up to 1 kHz	Up to 100 kHz
600 Ω	>100 dB	>60 dB
10 KΩ	> 80 dB	>40 dB

Printer and Timer

Type: Thermal Printer

Print modes: Manual: Initiates a printout of selected input channels; Automatic: Scans, measures and prints selected input channels at preset time intervals

Time interval: 1, 3, 6, 10, 18, 30, 60, or 180 seconds/minutes interval selectable via front panel pushbuttons

Timer: Internal 24-hour crystal controlled interval timer. Timer starts at 00:00:00 (HH:MM:SS). A time offset can be manually entered to synchronize the timer with the time of day.

Timer accuracy: Within 1 minute in 24 hours

Power failure protection: Should a momentary power failure occur (up to 5 seconds), the 3467A will retain the math constant, elapsed time, zero offsets, and ranges.

*Time intervals ≤10 seconds may be shorter than the actual time required to completely measure and print the selected channels.

General

Reading rate: Depends on input signal level. 2 to 4½ readings/second.

Operating temperature: 0°C to +50°C

Storage temperature: –40°C to +55°C without thermal paper

Thermal paper storage temperature: –40°C to +30°C

Humidity: 95% R.H., +40°C without thermal paper

60% R.H., +30°C with thermal paper

Power: 100/120/220/240 +5%, –10%

48 to 440 Hz line operation, <25 VA

Size: 190.5mm H × 212.9mm W × 304.8mm D (7.5" × 8.4" × 12")

Weight: Net: 4.77 kg (10.5 lbs.); **Shipping:** 5.44 kg (12 lbs.)

Accessories

Accessories	Price
5061-2003 Carrying Handle Kit (44416A is also required with this accessory)	\$39
44416A Rear Panel Support and Cord Wrap Kit	\$30
44414A Four Thermistor Pack	\$50
82045A Six Rolls of Thermal Paper	\$6

3467A Logging Multimeter (includes 1 roll of thermal paper and a thermistor) **\$2600**

DIGITAL VOLTMETERS

True RMS Voltmeter

Model 3403C

- DC and 2 Hz to 100 MHz
- 3½ digit

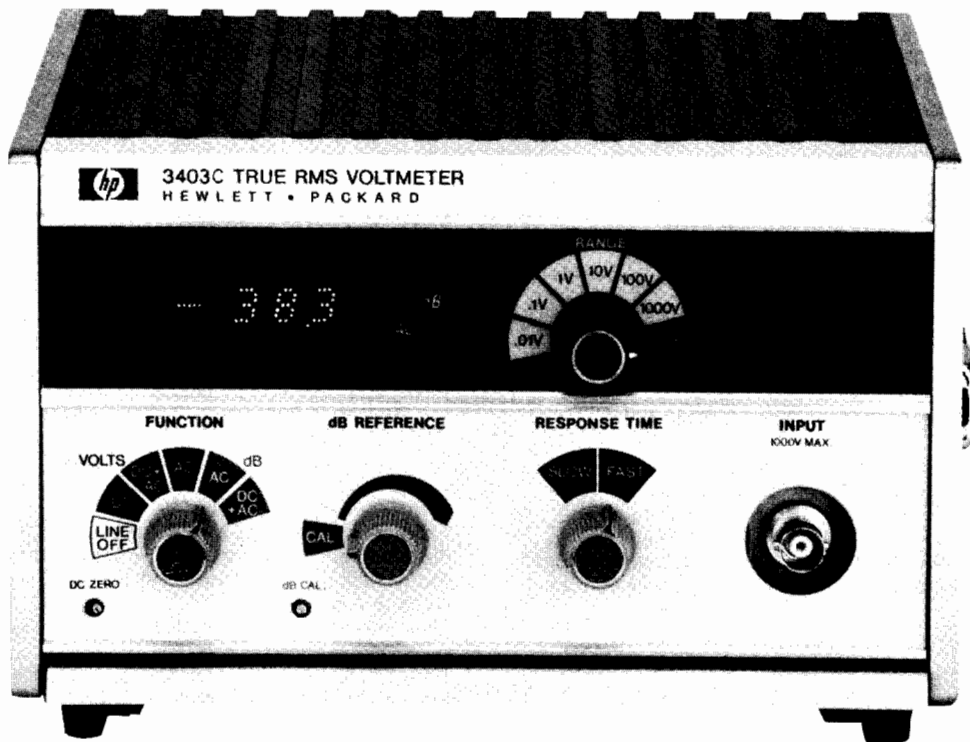

Description

The Model 3403C is usable from dc to 100 MHz. True rms is especially valuable for measurements of noise, multiplexed signals, modulated waves and signals with high harmonic content.

dB Display

The dB display option provides readings directly in dB, a major convenience to ac users. The dB reference to which the measurement is made is conveniently adjustable from the front panel to provide referenced dB measurements, or to provide a convenient means to offset the reading by as much as 13 dB for unreferenced measurements.

Specifications

Ranges

Full range display: 10.00 mV (ac only); 100.0 mV; 1.000 V; 10.00 V; 100.0 V; 1000 V.

Overrange: >90% on all ranges except as limited by max input voltage.

Ranging information: front panel annunciators indicate overrange (approximately 190% of full range), or underrange (approximately 17% of full range) conditions.

Performance

AC Frequency Range

- Slow response:** 2 Hz to 100 MHz.
- Fast response:** 25 Hz to 100 MHz.

Response Time

Fast response: 1 s.

Slow response: 10 s.

Instrument reads final reading $\pm 0.1\%$ of input change in stated response time.

Display Rate

Fast response: 4 readings per s.

Slow response: 2 readings per s.

READING ACCURACY = \pm (% OF RANGE + % OF READING)**

RANGE	% OF RANGE (VOLTS)			% OF READING (VOLTS)						
	DC	DC + AC	AC	DC	2 Hz	25 Hz	100 KHz	1 MHz	10 MHz	100 MHz
1000V	.3	.3	.3	.2	.4*	.2				
100V	.2	.2	.2	.2	.4*	.2	1			
10V	.2	.2	.2	.2	.4*	.2	.5	1		
1V	.2	.2	.2	.2	.4*	.2	.5	1	2.5	10
100mV	.6	.6	.2 40mV .4	.2	.4*	.2	.5	2	2.5	10
10mV			.2 4mV .4			.3	1.2	3	3	10

CAUTION: frequencies and ranges in this area may result in invalid readings without ranging indication.

* DC + AC function and slow response time only

** % of reading specification is representative of typical flatness.



Functions

DC: responds to dc component of input signal.

AC: responds to true rms value of ac coupled input signal.

AC+DC: responds to true rms value of dc and ac input signal; reading is $\sqrt{(dc)^2 + (ac \text{ rms})^2}$

Temperature coefficient: $\pm(0.1 \times \text{reading accuracy}^*/^\circ\text{C})$ outside the $25^\circ\text{C} \pm 5^\circ\text{C}$ temperature range.

*Data from accuracy charts.

Accuracy: 90 days ($25^\circ\text{C} + 5^\circ\text{C}$, $<95\% \text{ RH}$), 17% of range to 190% of range).

Input Characteristics

Input impedance: ($< 10 \text{ MHz}$):

1 V to 1000 V range: $10 \text{ M}\Omega \pm 10\%$ shunted by $24 \text{ pF} \pm 10\%$.

10 mV and 100 mV range: $20 \text{ M}\Omega \pm 10\%$ shunted by $20 \text{ pF} \pm 10\%$.

10 MHz to 100 MHz: the following table gives maximum loading due to input shunt impedance across a terminated source.

System impedance (source and load)	Frequency	
	10 MHz	100 MHz
50 Ω	1%	10%
75 Ω	2%	20%

Crest factor

2 Hz to 25 Hz	2:1 at full range input.
>25 Hz	10:1 at full range input.

Maximum Input Voltage

High to low: 1000 V rms, 1500 peak or 10^* V-Hz on any range. Maximum dc voltage in ac mode: 500 V dc.

Low to chassis: $\pm 500 \text{ V}$ dc, when floated with special banana to BNC adapter.

Options:

Autoranging (3403C option 001)

Automatic ranging: uprange at approximately 190% of full range; downranges at approximately 17% of full range.

Autorange time: fast response: 1 s per range change. Slow response: 10 s per range change.

Remote control + digital output + autoranging (3403C option 003): Provides remote control of all front panel functions, ranges, digital output and autoranging.

dB display (3403C option 006)

Measurement range: 108 dB (-48 dBV to $+60 \text{ dBV}$).

Calibrated dB reference: 0 dB = 1.000 V; reference level may be set for 0 dBm (600 Ω) by adjusting front panel dB calibration adjustment.

Variable dB reference: reference level may be shifted downward from calibrated position $> 13 \text{ dB}$.

dB recorder output: output voltage: 200 mV for 20 dB. Output resistance: $1 \text{ k}\Omega \pm 500 \Omega$.

Accuracy: 90 days ($25^\circ\text{C} + 5^\circ\text{C}$, $<95\% \text{ RH}$).

$$\text{READING ACCURACY} = \pm (\text{dB} + \pm \text{dB})^{**}$$

RANGE	dB		dB										
	AC	DC+AC	DC	2 Hz	25 Hz	100 KHz	1 MHz	10 MHz	100 MHz				
1000V	.15	.15	.02	.04*	.02								
100V	.15	.15	.02	.04*	.02					.1			
10V	.15	.15	.02	.04*	.02					.05	.1		
1V	.15	.15	.02	.04*	.02					.05	.1	2.5	1
100mV	.15	.15	.02	.04*	.02					.05	.2	2.5	1
10mV	.15				.03					.12	.3	2.5	1

CAUTION: frequencies and ranges in this area may result in invalid readings without ranging indication.

* DC + AC function and slow response time only

** specification is representative of typical flatness.

General

Operating Conditions

Temperature range: 0°C to 50°C .

Humidity: $<95\% \text{ RH}$.

Recorder Output

Output voltage: 1 V dc open circuit for full range input.

Output resistance: $1 \text{ k}\Omega \pm 10\%$.

Power: 115 V or 230 V $\pm 10\%$, 48 Hz to 440 Hz, 35 VA max. (including all options).

Input terminals: BNC front panel connector standard for low to high terminals; rear panel connector available by internally reversing position of ac converter module.

Weight: including all options: net, 5 kg (11 lb). Shipping, including all options: Net, 7.2 kg (16 lb).

Size: 127 H x 234.9 W x 196.8 mm D ($5'' \times 9.25'' \times 7.75''$).

Accessories furnished: floating adapter-banana to BNC.

3403C True RMS Voltmeter

\$3675

*Opt 001 autoranging

add \$170

*Opt 003 remote control + digital output + autoranging

add \$370

*Opt 006 dB display

add \$330

*Options 003 and 006 are available only as factory installed options.

DIGITAL VOLTMETERS

HP-IB 5 Function DMM

Model 3438A

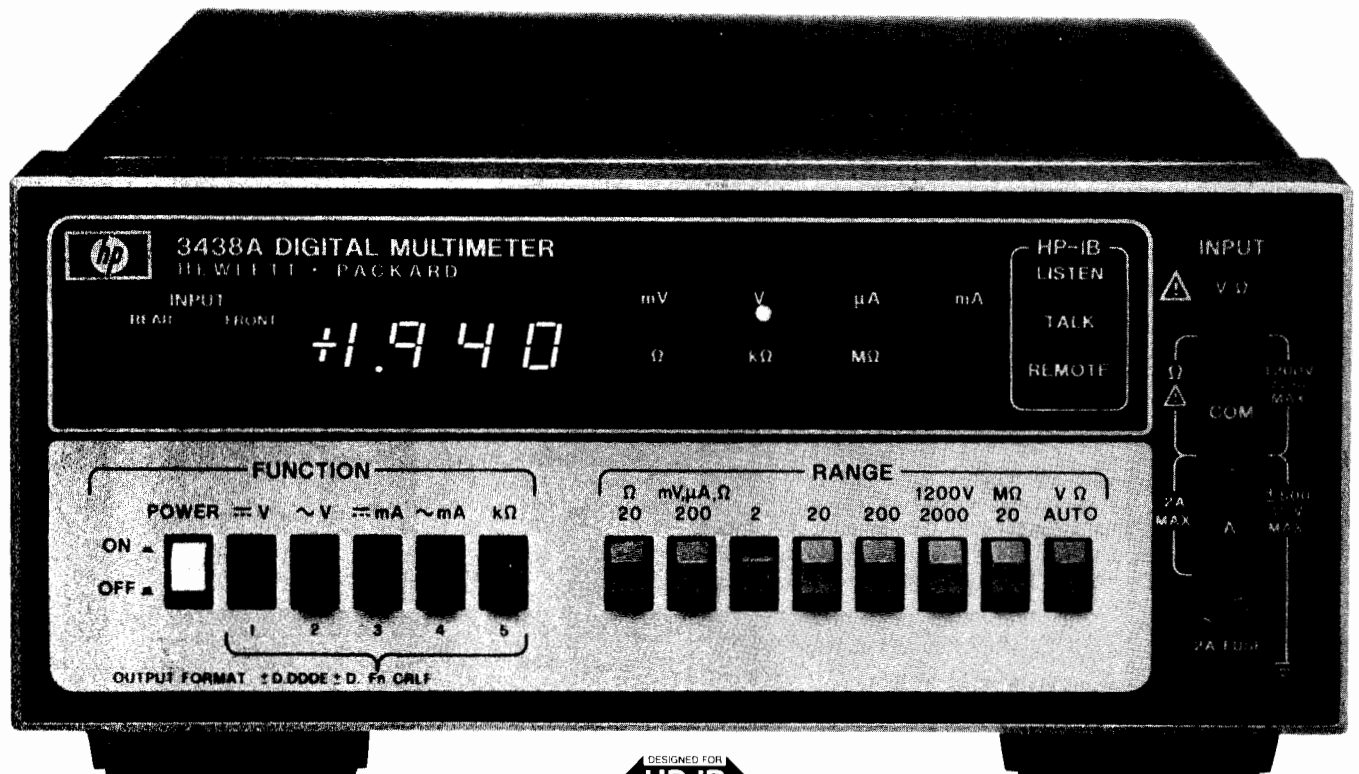

Description

The 3438A is an autoranging 3½ digit Multimeter with 5 functions of ACV, DCV, ACI, DCI, and Ω . It interfaces to the HP-IB providing both addressable and talk-only modes.

The addressable mode allows triggering either from the Calculating Controller (remote) or internally (local). Function and range are selected manually on the front panel with autoranging of volts and ohms.

Specifications

DC Voltmeter

Ranges:	Maximum display:
200 mV	± 199.9 mV
2 V	± 1.999 V
20 V	± 19.99 V
200 V	± 199.9 V
1200 V	± 1199 V

Maximum input: 1200 V (DC + peak AC).

Ranging: Automatic or manual.

Sensitivity: 100 μ V on 200 mV range.

Polarity: Automatically sensed and displayed.

Accuracy: (1 year, 15 to 30°C)

Range	Specifications
200 mV	$\pm (0.1\% \text{ of reading} + 2 \text{ counts})$
2 V to 1200 V	$\pm (0.1\% \text{ of reading} + 1 \text{ count})$

Temperature coefficient: (0 to 15°C and 30 to 55°C) $\pm (.015\% \text{ reading} + 0.1 \text{ count})/^\circ\text{C}$.

Input resistance: 10 meg $\Omega \pm 1\%$.

Input Type: floating, 500 V maximum com. to ground.

Normal Mode Rejection: >40 dB at 50 Hz and 60 Hz $\pm 0.1\%$

Response time: <0.7 seconds to within 1 count of final value on one range. Add 1 second for each range change.

Effective common mode rejection: (1 k Ω unbalance) > 120 dB at 50/60 Hz $\pm 0.1\%$.

DC Current

Ranges:	Maximum display:
200 μ A	± 199.9 μ A
2 mA	± 1.999 mA
20 mA	± 19.99 mA
200 mA	± 199.9 mA
2000 mA	± 1999 mA

Maximum input: current: 2 amp (fuse protected); voltage: 250 V

Ranging: manual only.

Sensitivity: 100 nA on 200 μ A range.

Polarity: automatically sensed and displayed.

Accuracy: (1 year, 15 to 30°C)

Range	Specifications
200 μ A to 200 mA	$\pm (0.3\% \text{ of reading} + 2 \text{ counts})$
2000 mA	$\pm (0.6\% \text{ of reading} + 2 \text{ counts})$

Temperature coefficient: (0 to 15°C and 30 to 55°C) $\pm (.028\% \text{ of reading} + 0.1 \text{ counts})/^\circ\text{C}$.

Voltage burden:

Range	Maximum Burden at Full Scale
200 μ A to 20 mA	< 220 mV
200 mA	< 240 mV
2000 mA	< 400 mV

Response time: <0.7 seconds on any range to within 1 count of final value.

AC Voltmeter

AC Converter: (average responding RMS calibrated)

Ranges:	Maximum display:
200 mV	199.9 mV
2 V	1.999 V
20 V	19.99 V
200 V	199.9 V
1200 V	1199 V



Maximum input: 1700 V (DC + Peak AC), 10⁷ Volt-Hz max.

Ranging: Automatic or manual.

Sensitivity: 100 μV on 200 mV range.

Accuracy (with display of ≥20 counts) 1 year, 15 to 30°C

Frequency	Specifications
30 Hz-50 Hz	±(1.5% of reading + 3 counts)
50 Hz-20 kHz	±(0.3% of reading + 3 counts)
20 kHz-100 kHz	±(1.5% of reading + 10 counts)

Temperature coefficient: (0 to 15°C and 30 to 55°C) ±(0.04% of reading + 0.2 count)/°C.

Input impedance: resistance: 5 meg Ω ±5%; shunt capacitance: <100 pf.

Response time: <1.6 seconds to within 3 counts of final value on one range. Add 1.2 seconds for each range change.

Input type: floating, 500 V maximum com. to ground.

AC Current

Ranges:	Maximum display:
200 μA	199.9 μA
2 mA	1.999 mA
20 mA	19.99 mA
200 mA	199.9 mA
2000 mA	1999 mA

Maximum input: current: 2 amp (fuse protected) voltage: 250 V.

Ranging: Manual only.

Sensitivity: 100 nA on 200 μA range.

Accuracy (With display of ≥20 counts) 1 year, 15 to 30°C

Current Range	30 Hz	50 Hz	10 kHz
2000 mA	±(2% of reading + 5 counts)	±(2% of reading + 5 counts)	±(1.2% of reading + 5 counts)
200 mA to 200 μA	±(1.7% of reading + 5 counts)	±(1.7% of reading + 5 counts)	±(0.9% of reading + 5 counts)

Temperature coefficient: (0 to 15°C and 30 to 55°C) ±(0.05% of reading + 0.2 counts)/°C.

Voltage burden

Range	Maximum Burden at Full Scale
200 μA to 20 mA	<220 mV RMS
200 mA range	<240 mV RMS
2000 mA range	<400 mV RMS

Response time: 1.6 seconds on any range to within 3 counts of final value.

Input type: floating, 500 V maximum com. to ground.

Ohmmeter

Ranges:	Maximum display
20 Ω	19.99 Ω
200 Ω	199.9 Ω
2 kΩ	1.999 kΩ
20 kΩ	19.99 kΩ
200 kΩ	199.9 kΩ
2000 kΩ	1999 kΩ
20 MΩ	19.99 MΩ

Input protection: 250 V RMS.

Ranging: automatic or manual.

Sensitivity: 10 milliohm on 20Ω range.

Accuracy (1 year, 15 to 30°C)

Range	Specifications
20 Ω	±(0.5% of reading + 12 counts)
200 Ω to 2 MΩ	±(0.2% of reading + 2 counts)
20 MΩ	±(0.8% of reading + 2 counts)

Temperature coefficient (0 to 15°C and 30 to 55°C)

Range	Specifications
20 Ω-2 MΩ	±(0.04% of reading + 0.2 counts)/°C
20 MΩ	±(0.18% of reading + 0.2 counts)/°C

Configuration: 2 wire.

Open circuit voltage: <5 V.

Current through unknown

Range	20Ω	200Ω	2 kΩ	20 kΩ	200 kΩ	2 MΩ	20 MΩ
Current	5 mA	5 mA	500 μA	50 μA	5 μA	500 nA	50 nA

Response time: <0.8 seconds to within 1 count. Add 0.8 seconds for each range change.

HP-IB

Data output format:

±X.XXX E±X, Fn CR LF (13 byte, fixed)

DISPLAY EXPONENT FUNCTION

Function Code: DCV, 1; ACV, 2; DCI, 3; ACI, 4; Ω, 5

Overload Indication: ±1.XXX E + 9

Talk Modes (Selected by internal switch)

Addressed to Talk

Local: continuously sampling input; outputs on Bus when addressed to talk.

Remote: samples input only on command from controller.

Talk only (used without controller)

Input: switch selectable, front or rear.

Reading rate: is function of input level and ranging (2.5 to 4.7/sec. if in proper range).

With Range Change

ACV, ACI: add 1.2 seconds for each range change. After arrival on proper range, the first six readings are always discarded. The seventh reading is output on Bus. Allow 1.6 seconds additional for first reading on Bus.

DCV, DCI, kΩ: Add 1 second for each range change. After arrival on proper range, the first reading is always discarded. Allow 310 ms additional for first reading on Bus.

General

Calibration: data sheet specifications guaranteed for 1 year.

Display: 7 segment red 0.3 inch high LED's. Function, range, HB-IB status and annunciation.

Reading rate: 2.4-4.7/sec. depending on input level.

A-D Conversion: dual slope.

Integration time: 100 msec.

Ranging: automatic or manual on ACV, DCV, and ohms. Manual only on AC & DC current.

Storage temperature: -40 to +75°C.

Operating temperature: (0 to 55)°C.

Humidity: 95% RH at +40°C.

Power: 48-440 Hz, 12 watts; 86-106 V Opt 100; 104-127 V Opt 115; 190-233 V Opt 210; 208-250 V Opt 230.

Size: 85.7 mm H x 209.6 mm W x 282.2 mm D (3.4" x 8.25" x 11.5").

Weight: 2.8 kg (6.2 lb).

Ordering Information

Item	Price
11000A Test leads, dual banana both ends	\$20
11002A Test leads, dual banana to dual alligator	\$17
11003A Test leads, dual banana to probe and alligator	\$15
11096B RF Probe 10 kHz to 700 MHz	\$120
34110A Soft vinyl carrying/operating case	\$40
34111A High-voltage Probe 40 kV DC	\$150
34112A Touch-Hold Probe	\$65
5061-0072 1/2 module rackmount kit	\$50
10631A HP-IB Cable 1 m (39.4")	\$60
10631B HP-IB Cable 2 m (78.7")	\$80
10631C HP-IB Cable 4 m (157.5")	\$90
10631D HP-IB Cable 1/2 m (19.7")	\$75

3438A Digital Multimeter

Opt 100, 115, 210, or 230 (specify one)

\$1050
N/C

DIGITAL VOLTMETERS

High Speed 3½ Digit System Voltmeter

Model 3437A

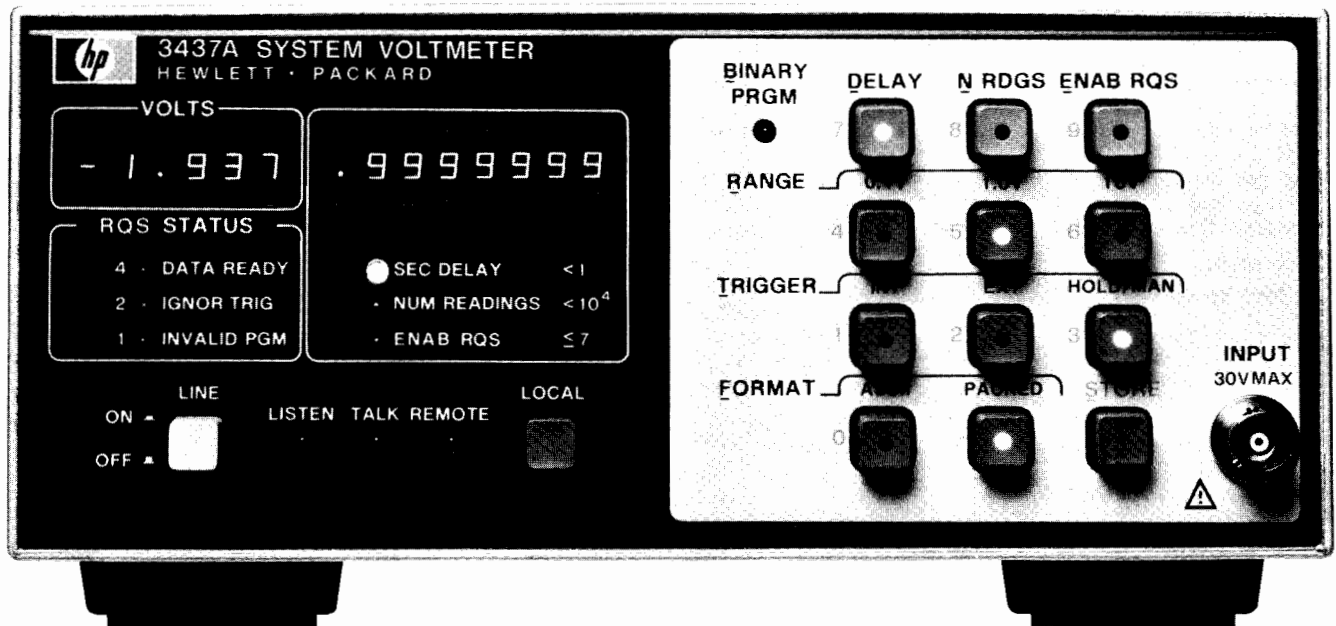

Description

The Hewlett-Packard 3437A System Voltmeter has been designed to be used in systems. It is a 3½ digit high speed dc voltmeter with sample and hold. The standard unit measures DC volts, provides trigger delay, burst reading capability and Hewlett-Packard Interface Bus (HP-IB).

There are three DC floating input ranges: 0.1V, 1.0V and 10.0V full scale with a maximum display of "1999." Sample and Hold allows the 3437A to be an instantaneous reading voltmeter. The trigger delay can be set from 0.1μs to 1.0 second and the number of readings can be set from 0 to 9999 readings.

Typical Operation

Example: set Delay to 1 ms and Number of Readings is set to 1000. The 3437A will now take 1000 readings spaced 1 ms apart upon receiving one trigger.

Data Output

All front panel switches are programmable from the HP-IB. Two data output formats are available: (1) ASCII output (Serial ASCII characters) and (2) Packed output (two 8-bit bytes on the HP-IB to send the complete reading).

High Speed

The Packed output mode allows more data to be stored in the calculator or computer as well as increasing the maximum reading rate from 3000 readings/second to greater than 5000 readings/second.

Systems Capability

The user may select the mode for which the voltmeter requests service from the controller. Request Service can be programmed manually or automatically to request service for: (1) Data Ready, (2) Trigger Ignore, or (3) Invalid Program. Any combination of these three can be selected.

Applications

Waveform analysis—The 3437A can be used to analyze a wide variety of waveforms. The delay and burst reading capability allows frequency, positive or negative peak values, RMS value and harmonic distortion to be measured. The accuracy of these measurements is comparable to more traditional measurement techniques.

Transient signal analysis—The 3437A is capable of measuring transient signals because of the wide bandwidth input (>1 MHz), high measuring speed and sample-and-hold.

Fast AC measurements—Sinusoidal signals of known frequency can be measured in less than one cycle of the signal. Very low frequency measurements can be made more quickly than with conventional techniques.

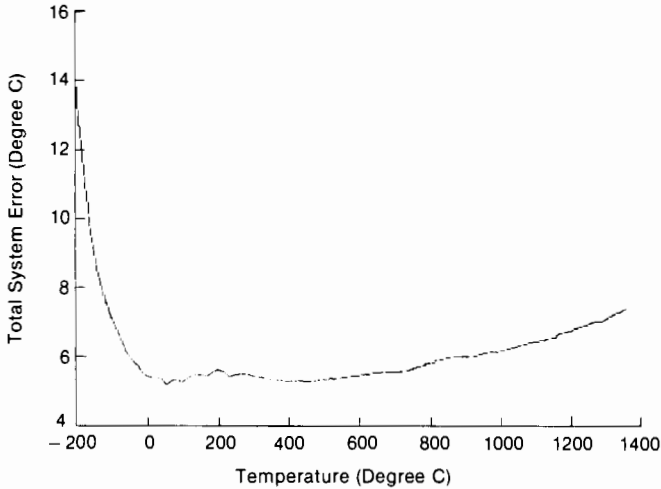

Figure 1 shows the performance of a 3437A when used to measure J type thermocouples. The 3437A can be used to measure multiple thermocouples at up to 4800 channels per second. Thermocouple linearization routines are provided in the 3054A Data Acquisition and Control System software.

High speed scanning: multiple input measurement applications can be satisfied with the 3437A and the HP 3497A Data Acquisition/Control Unit. Reading rates of up to 4800 channels/second can be attained.

Bench measurements: in addition to systems applications, the 3437A can be used to improve oscilloscope amplitude and measurement accuracy.

Data-Sheeted Systems

The 3437A is a component of the 3054A Automatic Data Acquisition and Control System. The 3054A includes the 3437A for high speed measurements, the 3456A Digital Voltmeter for high accuracy measurements and the 3497A Data Acquisition/Control Unit for multiplexing and control outputs. The 3054A includes an extensive software package to support the 3437A when used for thermocouple measurements, high speed scanning, and waveform digitization. The 3437A is also a component of the 3052A Data Acquisition System.

Specifications

DC Volts

Ranges	Max. Display	Overload Reading
10 V	±19.98	±99.99
1 V	±1.998	±9.999
0.1 V	±.1998	±.9999

Ranging: Manual or Remote.

Performance

Static accuracy (90 days, 23°C ± 5°C)

10 V range: ±(0.05% of reading + 1.6 counts.)

1 V range: ±(0.03% of reading + 1.6 counts.)

0.1 V range: ±(0.06% of reading + 1.8 counts.)

Static accuracy (1 year, 23°C + 5°C)

10 V range: ±(0.05% of reading + 2 counts.)

1 V range: ±(0.03% of reading + 2 counts.)

0.1 V range: ±(0.06% of reading + 2.2 counts.)

Static accuracy temperature coefficient (0°C–50°C): ±(0.002% reading + 0.05 counts) /°C.

Input Characteristics

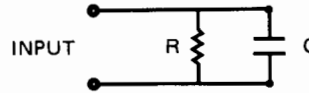

10 V range: R = 1 MΩ ± 20%; C < 75 pF.

1 V range: R > 10⁶Ω; C < 75 pF.

0.1 V range: R > 10⁶Ω; C < 75 pF.

Maximum input voltage high to low on all ranges: < ± 30 V peak.

Maximum voltage low to chassis: ± 42 V peak.

Number of Readings (N Readings): 0 to 9,999.

Readings are not internally stored.

For N = 0 the 3437 operates in delay mode only.

Maximum reading rate (Remote, N Rdgs. > 1, and a zero delay listener*)

ASCII: 3600 Readings/s.

PACKED: 5700 Readings/s.

Actual Reading Rate is given by
3600 (listen rate)

ASCII: $\frac{3600 + \text{listen rate}}{3600 + \text{listen rate}}$

Listen rate is the maximum speed at which the listener can accept 7 data bytes.
5700 (listen rate)

PACKED: $\frac{5700 + \text{listen rate}}{5700 + \text{listen rate}}$

Listen rate is the maximum speed at which the listener can accept 2 data bytes.

Delay

N Rdgs. = 0 or 1

DELAY (setting): 0 to 0.999 999 9 sec. in 0.1 μs steps.

N Rdgs. > 1 (Remote and a zero delay listener)

ASCII: 0.0002778 s ≤ DELAY ≤ 0.9999999 s.

PACKED: 0.0001754 s ≤ DELAY ≤ 0.9999999 s.

Minimum delay is a function of listener delay related by:

ASCII: 277.8 μs + listener delay.

PACKED: 175.4 μs + listener delay.

Accuracy (EXT. TRIG to DELAY OUT, 0°C to 50°C)

Delay offset: 100 ns ± 25 ns (with < 150 pF cable capacitance)

Delay accuracy: ±0.008% DELAY Setting + Delay offset.

Delay repeatability (jitter) for N Rdgs = 0 or 1

DELAY of 0 or 0.1 μs: 2 ns

DELAY of 0.2 μs to 50 ms: 10 ns + 0.0002% DELAY setting.

DELAY of > 50 ms: ± 110 ns.

Input bandwidth (3 dB)

10 V range: 1.0 MHz.

1 V range: 1.1 MHz.

0.1 V range: 40 kHz.

Settling Time:

10 V range: 10 V Range with 10 V step input:

Reading settles to within 30 mV of final value in 7.5 μs or to within 200 mV of final value in 700 ns.

1 V range: 1 V Range with 1 V step input:

Reading settles to within 3 mV of final value in 1.5 μs or to within 20 mV of final value in 700 ns.

0.1 V range: 0.1 V Range with .1 V step input

Reading settles to within 200 μV of final value in 25 μs.

General

Operating temperature: 0 to 55°C.

Storage temperature: -40°C to 75°C.

Humidity range: < 95% R.H., 0°C to 40°C.

Power: 100 V, 120 V, 220 V, 240 V +5%, -10%, 48 Hz to 440 Hz line operation, < 42 VA with all options.

Size: 88.9 mm H x 212.7 mm W x 527.1 mm D (3½" x 8⅜" x 20¾").

Weight: net, 5.6 kg (12 lb 4 oz). Shipping, 7.6 kg (16 lb 12 oz).

3437A System Voltmeter

\$2750



DIGITAL VOLTMETERS

3 1/2 to 6 1/2 Digit DVM for Bench/System Applications

Model 3456A

- Up to 330 rdgs/sec
- 100 nanovolt resolution
- Transfer standard performance
- 100 micro-ohm to 1.0 gigaohm measurement capability
- Offset Compensated Ohms (OC Ω)
- Fast AC

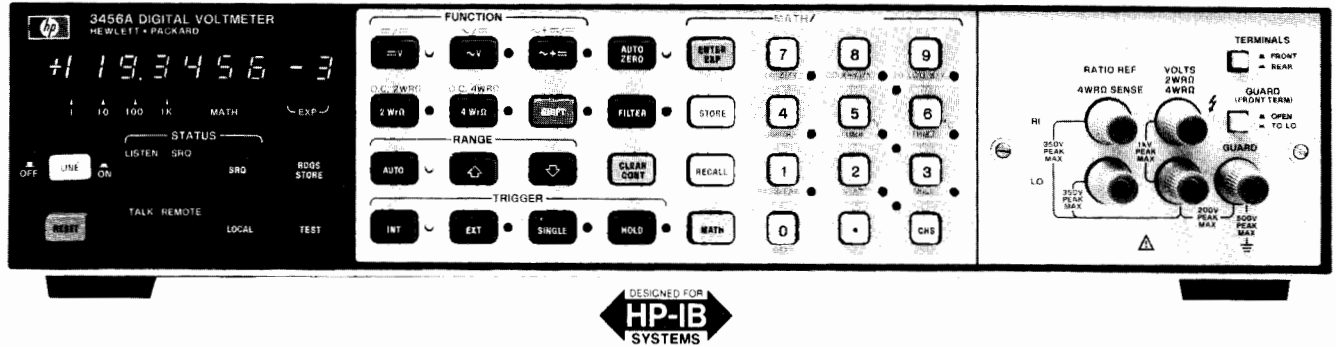

Description

This new microprocessor-based, fully guarded, integrating Digital Multimeter is designed for bench or systems use. Called the HP Model 3456A, the instrument measures dc, true RMS ac voltage and resistance.

Five full scale dc ranges from 0.1 volt to 1000 volts are provided. Measurement speed and accuracy can be enhanced for a specific application, using the HP 3456A's selectable integration time (up to 100 power line cycles) and settling time. An operator can select up to 330 readings/second for high speed bursts or one reading every fifteen minutes for periodic measurements. Resolution of 100 nanovolts at 48 readings/second (6 1/2 digits) to 10 microvolt resolution at 330 readings per second (3 1/2 or 4 1/2 digits) can be selected.

Because the HP 3456A uses an integration technique with new features such as "Program Memory" and "Reading Store", the operator can obtain the fastest possible reading rate with the most noise rejection. The first reading is correct, every time. The HP 3456A built-in memory is divided into two parts (Program and Reading Store). This feature lets the operator choose the length of program and the number of readings to be stored. For example, one could store an instrument command string 8 bytes long in program memory with room for 348 stored readings. The size of the HP 3456A memory is 1400 bytes long.

Transfer standard performance is assured with the HP 3456A. With good repeatability and 100 nanovolt sensitivity, accuracy on the ten volt range is $\pm 0.0008\% + 2$ counts over a 24-hour period at $23^\circ\text{C} \pm 1^\circ\text{C}$.

Four full-scale, true TRMS ac voltage ranges are provided, with reading speeds up to 12 per second speed over a 20 Hz to 250 kHz frequency range with 1 microvolt resolution (6 digits). Best accuracy is 0.05%. Crest factor is greater than seven at full scale.

New Ohms Technique

A technique called Offset Compensated Ohms is incorporated in the 3456A. The DMM compensates for any resistance inaccuracies that may be caused from thermally produced offset voltages in the circuit under test. In the ohms function, the instrument first measures the voltage drop across the circuit under test. The voltage measured is stored in the DMM. Simultaneously, the DMM supplies a fixed current through the circuit under test and measures the voltage drop. Since the thermal error first stored in in the DMM's memory, it is automatically eliminated from the measurement.

The measurement range is from 1 m Ω to 1.2 G Ω , using either 2 or 4 wire connections.

System DMM

Standard on the 3456A is an isolated HP-IB (IEEE-488) I/O for the systems operation. The front panel indicators on the 3456A display range, function and HP-IB status during remote operation. Also on the front panel is a SRQ (Service Request) button which can be

used to flag or interrupt a computer. With the 3456A's program memory and reading storage capability, system programmers and operators can use only one desktop or minicomputer to control numerous test stations, each containing a 3456A. By depressing the 3456A numerical entry keys and SRQ, the computer can be instructed to transfer a measurement sequence to the 3456A. The 3456A can take measurements and store them while a computer continues its operation as before the SRQ interrupt.

Another system feature of the 3456A is its hardware scanner advance capability for scanned or multiplexed system applications. As soon as the 3456A's measurement cycle is complete, a TTL signal is available to trigger an HP 3495A Scanner or 3497A Acquisition/Control Unit to advance to their next channel. Up to 330 channels can be scanned per second without computer interaction.

Bench DMM

With a 2 ppm stability, the HP 3456A is a true transfer standard offering either 100 nanovolt sensitivity or 0.001% accuracy. Other standard features include fast autorange and easy-to-use math functions. The user can scale, limit test, null and make measurements in percent error, dB and dBm, as well as themistor compensation in degrees F and C. A statistics function key (STAT) enables the operator to improve the 3456A's sensitivity, resolution and accuracy by averaging. Averaging reduces random noise fluctuations and improves sensitivity by a factor of the square root of the number of measurements. For example, for low level signals after 100 measurements, the actual sensitivity of the 3456A is approximately 10 nanovolts instead of 100 nanovolts. In addition, STAT enables the operator to recall the maximum (upper), minimum (lower), and variance.

Calibration of the HP 3456A is fast and convenient since all routine adjustments are accessible from a concealed door in the front panel. Should service be necessary, built-in diagnostics and PC Board modules make the HP 3456A easy to service.

Specifications

DC Voltage

Input characteristics:

RANGE	MAXIMUM READING (5 1/2 digit)		RESOLUTION		INPUT IMPEDANCE	MAXIMUM INPUT VOLTAGE
	5 1/2 digit	6 1/2 digit	5 1/2 digit	4 1/2 digit		
0.1 V	119999 V	100 nV	1 μV	10 μV	$>10^{10} \Omega$	$\pm 1000 \text{ V peak}$
1.0 V	1.19999 V	1 μV	10 μV	100 μV	$>10^9 \Omega$	
10.0 V	11.9999 V	10 μV	100 μV	1 mV	$>10^8 \Omega$	
100.0 V	119.999 V	100 μV	1 mV	10 mV	10 M $\Omega \pm 5\%$	
1000.0 V	1000.00 V	1 mV	10 mV	100 mV	10 M $\Omega \pm 5\%$	

Guard to chassis: $\pm 400 \text{ V peak}$
Guard to low: $\pm 200 \text{ V peak}$

Measurement Accuracy: \pm (% of Reading + Number of Counts).
Auto-zero on and filter off.

24 hour: 23°C \pm 1°C

RANGE	6½ digit (≥ 10 PLC) ^a	6½ digit (1 PLC)	5½ digit (.1 PLC)	4½ digit (.01 PLC)
0.1 V	.0022 + 24	0.0024 + 32	0.007 + 14	0.06 + 3
1.0 V	0.0009 + 4	0.0012 + 5	0.007 + 3	0.06 + 2
10.0 V	0.0008 + 2	0.0011 + 3	0.007 + 2	0.06 + 2
100.0 V	0.0011 + 3	0.0014 + 4	0.007 + 2	0.06 + 2
1000.0 V ^b	0.0011 + 2	0.0013 + 3	0.007 + 2	0.06 + 2

^aAdd .02 $\frac{\text{Input Voltage}}{1000}$ % to % of reading.

>90 days: 23°C \pm 5°C

Add \pm .0006% of Reading/month to 90 day accuracy.

Temperature coefficient: \pm (% of Reading + Number of Counts)/°C

RANGE	5½ Digit Display				
	0.1V	1.0V	10.0V	100.0V	1000.0V
Temp Coef.	0.0002 +0.2	0.0002 +0.02	.0002 +.002	0.0002 +0.02	0.0002 +0.02

For 6½ digits, multiply counts by 10. For 4½ digits, multiply counts by .1

Auto-zero OFF: (5½ digit). For a stable environment \pm 1°C, add 10 counts for 0.1 V range, 1 count for 1 V and 100 ranges, and .1 count for 10 V and 1000 V ranges. For 6½ digits, multiply counts by 10. For 4½ digits, multiply counts for .1.

Filter ON: Rejection is >60 dB at 50 Hz. Add 2 μ V for .1 V, 1.0 V and 10 V range and 200 μ V for 100 V and 1000 V range.

Response time:

Filter off: for preprogrammed settling times (0.0 seconds), error is <.005% of input voltage step.

Filter On: for preprogrammed settling times (.65 seconds), error is <.01% of input voltage step.

NOISE REJECTION (dB) (1 k Ω unbalance in Lo)

	AC ^a		DC ECMR
	NMR	ECMR	
.01 PLC or .1 PLC	0	90	140
≥ 1 PLC	60	150	140
≥ 1 PLC with filter	120	160	140

^aFor 50, 60 Hz (depending on option) \pm .09%

Measurement Accuracy: \pm (% of Reading + Number of Counts).
Auto-zero on, >1% of scale, and DC component <10% of AC component.

24 hour: 23°C \pm 1°C

Filter OFF Filter ON	FREQUENCY IN HZ				
	20 to 30	400-20k 30-20k	20k to 50k 20k to 50k	50k to 100k 50k to 100k	'100k to 250k '100k to 250k
6½ digit (≥ 1 PLC) ^a	.33 + 300	.05 + 440	.15 + 1500	.53 + 2700	5.0 + 6300
5½ digit (.1 PLC)	.34 + 33	.06 + 44	.16 + 150	.54 + 270	5.0 + 630
4½ digit (.01 PLC)	.39 + 5	.11 + 6	.21 + 17	.59 + 29	5.1 + 65

^aFrequencies > 100 kHz are specified for 1.0 V and 10 V ranges only.

>90 days: 23°C \pm 5°C (5½ digit)

Add \pm (.004% of Reading + 12 counts)/month to 90 day accuracy. For 6½ digit, multiply counts by 10. For 4½ digit, multiply counts by .1.

90 day: 23°C \pm 5°C

RANGE	6½ digit (≥ 10 PLC) ^a	6½ digit (1 PLC) ^a	5½ digit (.1 PLC)	4½ digit (.01 PLC)
0.1 V	0.0034 + 24	0.0035 + 32	0.008 + 14	0.06 + 3
1.0 V	0.0024 + 4	0.0025 + 5	0.007 + 3	0.06 + 2
10.0 V	0.0023 + 2	0.0024 + 3	0.007 + 2	0.06 + 2
100.0 V	0.0026 + 3	0.0027 + 4	0.007 + 2	0.06 + 2
1000.0 V ^b	0.0024 + 2	0.0025 + 3	0.007 + 2	0.06 + 2

^aIntegration Time in Power Line Cycles (PLC). For 5½ digits, multiply counts by 0.1. For 4½ digits, multiply counts by 0.01.

MAXIMUM READING RATES (RDGS/S)

	Remote		Bench	
	60 Hz	50 Hz	60 Hz	50 Hz
4½ digit	330	290	200	167
5½ digit	210	180	150	125
6½ digit	48	40	46	38

For more detail, see "Reading Rates"

AC RMS Voltage (ac, ac + dc)
Input characteristics

RANGE	MAXIMUM READING		RESOLUTION		INPUT IMPEDANCE	MAXIMUM INPUT VOLTAGE
	(5½ digit)	6½ digit	5½ digit	4½ digit		
1.0 V	1.19999 V	1 μ V	10 μ V	100 μ V	1 M Ω \pm 5% shunted by <90 pF	\pm 1000 V peak (700 V rms) 10 ⁶ VHZ
10.0 V	11.9999 V	10 μ V	100 μ V	1 mV		
100.00 V	119.999 V	100 μ V	1 mV	10 mV		
1000.0 V	700.00 V	1 mV	10 mV	100 mV		

Guard to Chassis: \pm 500 V peak

Guard to Low: \pm 200 V peak

Temperature coefficient: \pm (% of Reading + Number of Counts)/°C. (5½ digit) \pm (.008 + 6)/°C for DC component <10% AC component. Otherwise add \pm (.008 + 12)/°C. For 6½ digit, multiply counts by 10. For 4½ digit, multiply counts by .1.

DC Component > 10% of AC Component: (5½ digit) Add \pm (.05% of Reading + 50 counts) to accuracy. For 6½ digit, multiply counts by 10. For 4½ digit, multiply counts by .1. For signals with no ac component, use the 1 kHz ac spec.

Crest factor: > 7:1 at full scale.

Common mode rejection (1 k Ω unbalance in Lo): >90dB dc to 60 Hz.

Auto-zero OFF: For stable environment \pm 1°C no accuracy change.

Response time: for preprogrammed settling times, error is <.1% of input voltage step.

Filter OFF: 0.06 seconds

Filter ON: .80 seconds

90 day: 23°C \pm 5°C^a

Filter OFF Filter ON	FREQUENCY IN HZ				
	20 to 30	400-20k 30-20k	20k to 50k 20k to 50k	50k to 100k 50k to 100k	'100k to 250k '100k to 250k
6½ digit (≥ 1 PLC) ^a	.35 + 500	.07 + 700	.17 + 1700	.55 + 2900	5.0 + 6500
5½ digit (.1 PLC)	.36 + 53	.08 + 73	.18 + 173	.56 + 293	5.0 + 653
4½ digit (.01 PLC)	.41 + 7	.13 + 9	.23 + 19	.61 + 31	5.1 + 67

^aIntegration Time in Power Line Cycles (PLC). For 5½ digits, multiply counts by 0.1. For 4½ digits, multiply counts by 0.01.

DIGITAL VOLTMETERS

3½ to 6½ Digit DVM for Bench/System Applications

Model 3456A

Resistance (2 WrΩ, 4 WrOCΩ, 4 WrOCΩ)
Input characteristics:

RANGE	MAXIMUM READING (5½ digit)	RESOLUTION			CURRENT THROUGH UNKNOWN	MAXIMUM VALID READING VOLTAGE	MAXIMUM OPEN CIRCUIT VOLTAGE
		6½ digit	5½ digit	4½ digit			
100 Ω	119.999 Ω	100 μΩ	1 mΩ	10 mΩ	1 mA	.12 V	5.5 V
1 kΩ	1199.99 Ω	1 mΩ	10 mΩ	100 mΩ	1 mA	1.2 V	5.5 V
10 kΩ	11.9999 kΩ	10 mΩ	100 mΩ	1 Ω	100 μA	1.2 V	5.5 V
100 kΩ	119.999 kΩ	100 mΩ	1 Ω	10 Ω	50 μA	6 V	9.5 V
1 MΩ	1199.99 kΩ	1 Ω	10 Ω	100 Ω	5 μA	6 V	9.5 V
10 MΩ	11.9999 MΩ	10 Ω	100 Ω	1 kΩ	500 nA	6 V	9.5 V
100 MΩ	119.999 MΩ	100 Ω	1 kΩ	10 kΩ	≤500 nA ¹	5 V	5.5 V
1 GΩ	1000.00 MΩ	1 kΩ	10 kΩ	100 kΩ	≤500 nA ¹	5 V	5.5 V

¹Ohms source is a 500 nA current source in parallel with a 10 MΩ resistance.

Non-destructive overload: 350 V peak
Measurement accuracy: ±(% of Reading + Number of Counts).
Auto-zero on, filter off, and 4-wire ohms.

24 hour: 23°C ±1°C

RANGE	6½ digit (≥10 PLC) ²	6½ digit (1 PLC)	5½ digit (.1 PLC)	4½ digit (.01 PLC)
100 Ω	0.003 + 24	0.003 + 32	0.009 + 14	0.07 + 3
1 kΩ	0.002 + 4	0.003 + 5	0.008 + 3	0.07 + 2
10 kΩ	0.002 + 4	0.003 + 5	0.008 + 3	0.07 + 2
100 kΩ	0.002 + 2	0.003 + 3	0.008 + 2	0.07 + 2
1 MΩ	0.006 + 2	0.006 + 3	0.012 + 2	0.07 + 2
10 MΩ	0.041 + 2	0.041 + 3	0.07 + 2	0.12 + 2
100 MΩ	1.3 + 1	1.3 + 1	1.5 + 1	1.5 + 1
1 GΩ	11 + 1	11 + 1	13 + 1	13 + 1

>90 days: 23°C ±5°C

Add ±.0006% of Reading/month to 90 day accuracy.

2-Wire Ohms Accuracy: Same as 4-wire ohms except add a maximum of .2 ohm offset.

Auto-Zero OFF Accuracy: (5½ digit). For a stable environment ±1°C, add 10 counts for 100 Ω range, 1 count for 1 kΩ and 10 kΩ range, and .2 counts for ≥100 kΩ range. Changes in lead resistance are not corrected in 4-wire ohms. For 4½ digit, multiply counts by .1. For 6½ digit, multiply counts by 10.

RANGE	MAXIMUM LEAD RESISTANCE FOR 4-WIRE OHMS	MAXIMUM OFFSET VOLTAGE FOR OFFSET COMPENSATED OHMS	PREPROGRAMMED SETTling TIME IN SECONDS
100 Ω	10 Ω	.01 V	0
1 kΩ	100 Ω	.1 V	0
10 kΩ	1000 Ω	.1 V	0
100 kΩ	1000 Ω	.5 V	.0008
1 MΩ	1000 Ω		.008
10 MΩ	1000 Ω		.08
100 MΩ	1000 Ω		.08
1 GΩ	1000 Ω		.08

Offset compensated ohms accuracy: same as 2-wire and 4-wire except maximum reading may be reduced by 9% for large offset voltages.

Response time: with preprogrammed settling time and <200 pF of capacitance, first reading is in specification.

Filter is not operational in ohms.

Temperature coefficient: (5½ digits) ±(% of Reading + Number of Counts)/°C

RANGE	1 kΩ					
	100Ω	10 kΩ	1 MΩ	10 MΩ	100 MΩ	1 GΩ
Temp Coef.	.0004 +2	.0004 +.02	.0004 +.004	.0010 +.004	.16 +0	1.6 +0

4½ digit: multiply counts by .1; 6½ digit: multiply counts by 10.

90 day: 23°C ±5°C

RANGE	6½ digit (≥10 PLC) ²	6½ digit (1 PLC) ²	5½ digit (.1 PLC)	4½ digit (.01 PLC)
100 Ω	0.004 + 24	0.004 + 32	0.01 + 14	0.07 + 3
1 kΩ	0.003 + 4	0.004 + 5	0.009 + 3	0.07 + 2
10 kΩ	0.003 + 4	0.004 + 5	0.009 + 3	0.07 + 2
100 kΩ	0.003 + 2	0.004 + 3	0.009 + 2	0.07 + 2
1 MΩ	0.007 + 2	0.007 + 3	0.013 + 2	0.07 + 2
10 MΩ	0.042 + 2	0.042 + 3	0.07 + 2	0.12 + 2
100 MΩ	1.8 + 1	1.8 + 1	2.0 + 1	2.0 + 1
1 GΩ	16 + 1	16 + 1	18 + 1	18 + 1

²Integration Time in Power Line Cycles (PLC). For 5½ digits multiply counts by 0.1. For 4½ digits multiply counts by 0.01.

MAXIMUM READING RATES (RDGS/S) (100 TO 10 kΩ RANGES)

	Remote		Bench	
	60 Hz	50 Hz	60 Hz	50 Hz
4½ digit	330	290	200	167
5½ digit	210	180	150	125
6½ digit	48	40	46	38

For more detail, see "Reading Rates"

Ratio

Type: DC/DC, AC/DC, or (AC + DC)/DC

Method: 4-wire with Volts Lo input common

$$\text{Ratio} = \frac{\text{Signal Voltage}}{\text{Ref. Hi Voltage} - \text{Ref. Lo Voltage}}$$

Signal Measurement: Same as DC Volts, AC Volts, or AC + DC Volts

Reference Measurement: Automatically selects .1 V, 1 V, or 10 V DC. Volts range and a 0.0 msec. settling time. Filter is off.

Maximum reference voltages:

Ref. Hi: ±12 V

Ref. Lo: ±9% of Ref. Hi

Ref. Hi-Ref. Lo: ±11.9999 V

Protection: ±350 V peak

Accuracy: Total % signal error + total % reference error (same as .1 V, 1 V, or 10 V DC volts)

Reading Rate

Reading rates are with autorange, math, display and filter off. Output is to internal memory using internal trigger and packed mode. Packed output in place of internal memory adds .35 ms; ASCII output adds 2.3 ms.

Rates vs. integration time and Auto-Zero: DC volts and 100 Ω thru 10 kΩ ranges with preprogrammed settling times (-0.0 sec.). Also, AC or AC + DC Volts and 100 kΩ thru 10 kΩ ranges with 0.0 sec. delay.



RATES

INTEGRATION TIME IN POWER LINE CYCLES (PLC)	Auto Zero OFF		Auto Zero ON	
	60 Hz	50 Hz	60 Hz	50 Hz
0.01 (4½ digit)	330	290	210	180
0.10 (5½ digit)	210	180	120	100
1.00 (6½ digit)	48	40	25	20
10.00 (6½ digit)	5.8	40	2.9	2.4
100.00 (6½ digit)	.57	.47	.29	.24

Memory

Reading Store: Can store up to 350 readings.

Can be recalled from HP-IB interface or front panel

Program memory: Can execute an internal program which controls instrument configuration and measurement sequence. Program is input from the HP-IB interface with up to 1400 ASCII characters.

Memory size: Total size is 1400 bytes. Memory used is 1 byte per ASCII character + 4 bytes per reading stored.

Math Function Specifications

General: Math function specifications do not include error in X (instrument reading) or in entered values (R, L, U, Y, Z). Range of values input or output is 0.000000×10^{-9} to $\pm 1999999 \times 10^0$. Out of range values send "OL" to display and $+1999999 \times 10^0$ to HP-IB.

Pass/Fail: Displays "HI" for values upper limit (U), "LO" for values lower limit (L), and X for values between the limits, with no introduced error. SRQ mask can be programmed to respond to out-of-limit conditions.

Maximum execution time: 20 ms

Statistics:

$$\text{Mean (M)} = X_1 + \frac{1}{C} \sum_{i=1}^C (X_i - X_1)$$

$$\text{Variance (V)} = \frac{\sum_{i=1}^C (X_i - X_1)^2 - \frac{1}{C} \left[\sum_{i=1}^C (X_i - X_1) \right]^2}{C - 1}$$

Maximum (U) and Minimum (L) are the most positive and negative instrument readings, respectively. X is displayed during calculation of statistics.

X_1 is the first reading taken after enabling statistics and is stored in the Z register. The number of readings taken (C) is stored in the count register.

$$\text{Accuracy of Mean: } < \pm \frac{C(U-L)}{10^{11}} + 1 \text{ LSD}$$

$$\text{Accuracy of Variance: } < \pm \frac{C(U-L)^2}{10^8} + 1 \text{ LSD}$$

Maximum execution time: 50 ms

Null: $X - X_1$ (X_1 is the first valid reading taken after enabling null and is stored in the Z register).

Maximum execution time: 15 ms

dBm(R): $10 \log \left| \frac{x^2/R}{1 \text{ mW}} \right|$ R is the user-entered impedance.

Output range: -280 to +340 dBm

Accuracy: $\pm .001$ dBm

Maximum execution time: 150 ms

Thermistor (F): Converts resistance of thermistor HP0837-0164, YSI 44007, Omega UUA35J3, and Fenwal UUA35J1 to temperature in °F.

Output range: -112 to 302°F

Accuracy: $-103 \leq T \leq +266^\circ\text{F}$: $\pm .11^\circ\text{F}$ max.

$-112 \leq T \leq +302^\circ\text{F}$: $\pm .27^\circ\text{F}$ max.

Accuracy specification does not include any inaccuracies in the actual thermistor used.

Maximum execution time: 100 ms

Scale: (X-Z)/Y

Accuracy: ± 1 LSD

Maximum execution time: 60 ms

dB: $20 \log \frac{X}{Y}$

Output Range: -620 to +620 dB

Accuracy: .001 dB

Maximum execution time: 100 ms

% Error: $100 \times (X-Y)/Y$

Accuracy: ± 1 LSD

Maximum execution time: 60 ms

General

Operating Temperature: 0 to 50°C

Warmup time: one hour to meet all specifications

Humidity range: 95% R.H., 0 to 40°C

Storage temperature: -40 to +75°C

Power: 100/120/240 V $\pm 5\%$, -10%, 48 Hz to 66 Hz line operation, 60 VA; 220 V $\pm 10\%$, 48 Hz to 66 Hz line operation, 60 VA.

Size: 88.9 mm H x 425.5 mm W x 527.1 mm D (3½" x 16¼" x 20¾")

Weight: Net, 10.49 kg (23.13 lbs.); Shipping, 13.35 kg (29.38 lbs.)

Ordering Information

	Price
10631A: 1 Meter (39.37 in.) HP-IB Cable	\$60
10631B: 2 Meter (78.74 in.) HP-IB Cable	\$65
10631C: 4 Meter (157.48 in.) HP-IB Cable	\$75
10631D: 0.5 Meter (19.69 in.) HP-IB Cable	\$60
03456-90001: Operating information supplement (one furnished with 3456A)	\$2.50
11000A: Test Leads, dual banana both ends	\$17
11002A: Test Leads, dual banana to probe and alligator	\$12
34111A: High Voltage Probe, 40 kV	\$150
Opt 050: Noise rejection for 50 Hz	N/C
Opt 060: Noise rejection for 60 Hz	N/C
Front Handle Kit (Opt 907) Pt. #5061-0088	+\$28
Rack Mount Kit (Opt 908) Pt. #5061-0074	+\$15
Rack Mount Kit (Opt 909) Pt. #5061-0075	\$41
Extra Operating and Service Manual (Opt 910)	+\$21.50

Model 3456A Digital Voltmeter

\$3700

DIGITAL VOLTMETERS

5½ / 6½-Digit DVM with Auto Cal

Model 3455A

- AutoCal
- Self test
- Bench/system
- AC/DC/OHMS
- High speed
- Removable reference

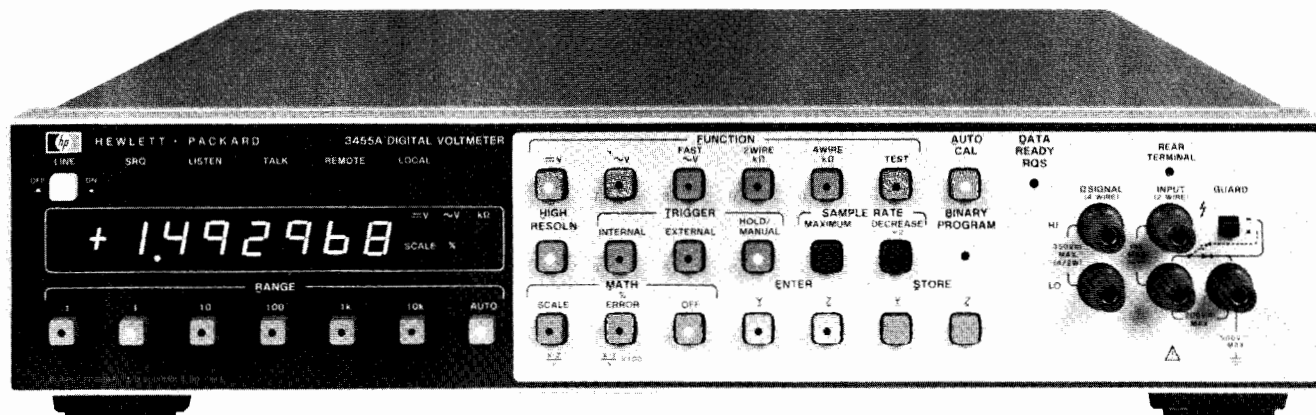

3455A



Description

Hewlett-Packard's 3455A Digital Voltmeter is a microprocessor controlled 5½- or 6½-digit integrating voltmeter for bench or systems applications. The standard instrument measures DC volts, AC volts, and resistance. HP-IB I/O for systems applications is also standard.

Measuring Speed

The 3455A is fully guarded and has greater than 60 dB normal mode noise rejection at reading rates of up to 24 readings per second on all DC ranges. Ohms reading rates are up to 12 readings/second and an AC fast mode gives reading rates of up to 13 readings/second at frequencies above 300 Hz. (Readings/seconds given for 60 Hz operation and high resolution off.)

Performance

DC measurements can be made with up to 1μV sensitivity. Ohms measurements are made with either a 2-wire and 4-wire mode. The High Resolution (6½-digit) mode gives DC and Ohms measurements with greater than 1 part per million resolution.

True rms

The standard true rms converter gives AC measurements from 30 Hz to 1 MHz. Complex signals with crest factors of up to 7:1 at full scale can be measured.

Math

The math functions provide computational capability. The Scale mode ($\frac{X-Y}{Y}$) allows the user to offset, take ratios, or scale readings to give readouts in physical units. The % Error mode ($\frac{X-Y}{Y} \times 100\%$) converts readings into percentage change from Y which is entered as a reference. For the math functions X is the present reading. Y and Z are previously entered readings or numbers entered from the front panel or by remote program.

Auto Cal

The auto cal feature gives the user accurate DC volts and ohms measurements and simplifies calibration of these functions. The DC and ohms operating circuits are checked against internal references and any errors are corrected digitally. All dc and ohms adjustments are in a removable reference assembly.

Serviceability

Routine maintenance and calibration has been simplified with the removable reference assembly. Calibration of DC and ohms functions can be done by replacing the reference assembly with a recently calibrated one. Extra reference assemblies are available as HP accessory number 11177A. A spare assembly is ideal for one or more 3455A's. Calibrate DC and ohms in a 3455A without removing it from the bench or system. Just return the extra reference assembly to the cal lab or HP for calibration and have it back in time to calibrate the 3455A next time.

The self-test feature is used to aid in troubleshooting as well as verifying operation of the 3455A. Test verifies proper operation of the DC measuring circuits by comparing their parameters against predetermined limits. If a problem is found, the display is used to assist in finding the problem area by indicating which parameter is in error. Detailed troubleshooting can then be used to quickly isolate the problem.

Specifications

Ranges		Maximum Display	
0.1	—	±0.149999 V	—
1	1	±1.49999 V	±1.499999 V
10	10	±14.9999 V	±14.99999 V
100	100	±149.999 V	±149.9999 V
1000	1000	±1000.00 V	±1000.000 V

Performance (High Resolution Off)

Accuracy ± (% of reading + counts)

24 hrs: 23°C ± 1°C		
Range	High Resolution Off	High Resolution On
0.1 V	0.004 + 4	—
1 V	0.003 + 1	0.003 + 4
10 V	0.002 + 1	0.002 + 3
100 & 1000 V	0.004 + 1	0.004 + 3
90 days: 23°C ± 5°C		
Range	High Resolution Off	High Resolution On
0.1 V	0.007 + 4	—
1 V	0.006 + 1	0.006 + 4
10 V	0.005 + 1	0.005 + 3
100 & 1000 V	0.007 + 1	0.007 + 3

Input Characteristics

Input resistance: 0.1 V through 10 V range: >10¹⁰ ohms. 100 V and 1000 V range: 10 megohm ±0.1% with Auto Cal. "off."

Maximum input voltage

High to low input terminals: ±1000 V peak.

Guard to chassis: ±500 V peak.

Guard to low terminal: ±200 V peak.

Normal mode rejection (NMR): NMR is the ratio of the peak normal-mode voltage to the peak error voltage in the reading.

NMR at 50 or 60 Hz ±0.1%: >60 dB.

Effective common mode rejection (ECMR): ECMR is the ratio of the peak common-mode voltage to the resultant peak error voltage in the reading.

ECMR with 1 kΩ unbalance in low lead at

DC: >140 dB.

50 Hz or 60 Hz ±0.1%: >160 db.

AC Voltage (rms Converter)

(High Resolution On or Off)

Ranges:	1.00000 V	Maximum Display:	1.49999 V
	10.0000 V		14.9999 V
	100.000 V		149.999 V
	1000.00 V		1000.00 V

Range selection: Manual, Automatic or Remote.

Function selection: ACV or Fast ACV.

Input Characteristics

Input impedance

Front terminals: 2 MΩ ±1% shunted by less than 100 pf.

Rear terminals: 2 MΩ ±1% shunted by less than 75 pf.

Maximum input voltage

High to low terminals: ±1000 volts peak.

Subject to a 10⁷ volts—Hz limitation.

Guard to chassis: ±500 V peak.

Guard to low terminal: ±200 V peak.

Response Time

ACV and FAST ACV

First reading to <0.1% of step size when triggered coincident with step change when on correct range (for AC signals with no DC component).

Performance (rms Converter)

Accuracy: ± [% of reading + counts]¹ (AC Coupled)²

Fast ACV	300 Hz to 20 kHz	20 kHz to 100 kHz	100 kHz to 250 kHz	250 kHz to 500 kHz	500 kHz to 1 MHz
	30 Hz to 20 kHz				
24 hours 23°C ± 1°C	0.04 + 40	0.40 + 80	1.80 + 200	4.0 + 400	5.00 + 2600
90 days 23°C ± 5°C	0.05 + 50	0.50 + 100	2.00 + 250	5.00 + 500	6.00 + 3100

¹Guard must be connected to low. Specifications are only for input levels above 1% of range. For AC coupled inputs <1% of full scale: add 20 counts to above accuracy table, except for AC coupled inputs above 50 kHz and <5% of full scale: add 170 counts to above accuracy table. See footnote 2 for AC/DC coupled inputs.

²For any AC/DC coupled input: add (0.05% of reading + 20 counts) to above accuracy table, except for an AC/DC coupled input above 50 kHz and <5% of full scale: add 170 counts to above accuracy table.

³Frequencies of greater than 100 kHz are specified for the 1 V and 10 V ranges only.

⁴Accuracy is not specified if the volt-hz product exceeds 10⁷. For inputs > 500 V, multiply the above tabulated accuracy by $\frac{1500 + V_{in}}{1000}$.

Ohms

Ranges		Maximum Display	
High Resolution Off	High Resolution On	High Resolution Off	High Resolution On
0.100000 kΩ	—	0.149999 kΩ	—
1.00000 kΩ	1.000000 kΩ	1.49999 kΩ	1.499999 kΩ
10.0000 kΩ	10.00000 kΩ	14.9999 kΩ	14.99999 kΩ
100.000 kΩ	100.0000 kΩ	149.999 kΩ	149.9999 kΩ
1000.00 kΩ	1000.000 kΩ	1499.99 kΩ	1499.999 kΩ
10000.0 kΩ	10000.00 kΩ	14999.9 kΩ	14999.99 kΩ

Range selection: Manual, Automatic, or Remote.

Performance

Function selection: 2-wire kΩ or 4-wire kΩ.

Accuracy ± (% of reading + counts) 4-wire kΩ

24 hours: 23°C ± 1°C		
Range	High Resolution Off	High Resolution On
0.1 kΩ	0.003 + 4	—
1 kΩ	0.003 + 1	0.0025 + 4
10 kΩ	0.005 + 2	0.0045 + 4
100 kΩ	0.002 + 2	0.0020 + 5
1000 kΩ	0.012 + 5	0.0120 + 4
10,000 kΩ	0.10 + 5	0.1000 + 4
90 days: 23°C ± 5°C		
Range	High Resolution Off	High Resolution On
0.1 kΩ	0.005 + 5	—
1 kΩ	0.005 + 1	0.0035 + 5
10 kΩ	0.007 + 2	0.0060 + 5
100 kΩ	0.004 + 2	0.0035 + 6
1000 kΩ	0.014 + 5	0.0135 + 5
10,000 kΩ	0.100 + 5	0.1000 + 5

2-wire kΩ: all accuracy specifications are the same as 4-wire kΩ except add 0.0004 kΩ to all readings.

Input Characteristics

Maximum voltage generated across unknown: <5 volts for open circuit; <4.7 volts for valid reading.

Signal source driving unknown (nominal): 0.1 kΩ, 1 kΩ & 10 kΩ ranges.

Overload Protection

Non-destruction: ±350 V peak.

Maximum reading rates for remote operations. (Readings/Sec)

Function	High Resolution ON		High Resolution OFF	
	50 Hz	60 Hz	50 Hz	60 Hz
DCV	5	6	22	24
Ohms	2.5	3	11	12
ACV (rms)			1.1	1.3
Fast ACV (rms)			12	13
ACV (Ave)			1.1	1.3
Fast ACV (Ave)			12	13

Math

Scale ($\frac{X-Z}{Y}$): X is present reading. Y and Z are previously entered readings, or numbers entered from the front panel or by external program.

Maximum number (entered or displayed): ±199,999.9.

Accuracy: ± (Accuracy of X reading ± 1 digit of displayed answer). This assumes no "Y" or "Z" error.

%Error ($\frac{X-Z}{Y} \times 100\%$): X is present reading. Y is a previously entered reading, or number entered from the front panel or by external program.

Maximum number (entered or displayed): ±199,999.9.

Accuracy: ± (Accuracy of X reading ± 1 digit of displayed answer). This assumes no "Y" error.

How to enter numbers in "Y" or "Z"

From a current displayed reading: press STORE "Y" or "Z".

From front panel: Press ENTER "Y" or "Z". The front panel is now set for numerical entry. These numbers are in blue next to the keys. Enter number and press STORE "Y" or "Z".

By remote program: send program codes for equivalent front panel operations.

General

Power: 100 V, 120 V, 240 V +5% -10%, 48 Hz to 400 Hz line operation; <60 VA with all options.

Size: 88.9 H x 425.5 W x 527.1 mm D (3.5" x 16.75" x 20.75").

Weight: net, 9.38 kg (20.7 lb). Shipping, 11.8 kg (26 lb).

Options

001: Average converter

3455A Digital Voltmeter

Price

less \$200

\$4,250

DIGITAL VOLTMETERS

Five-Digit Digital Multimeter with Self Test

Model 3490A

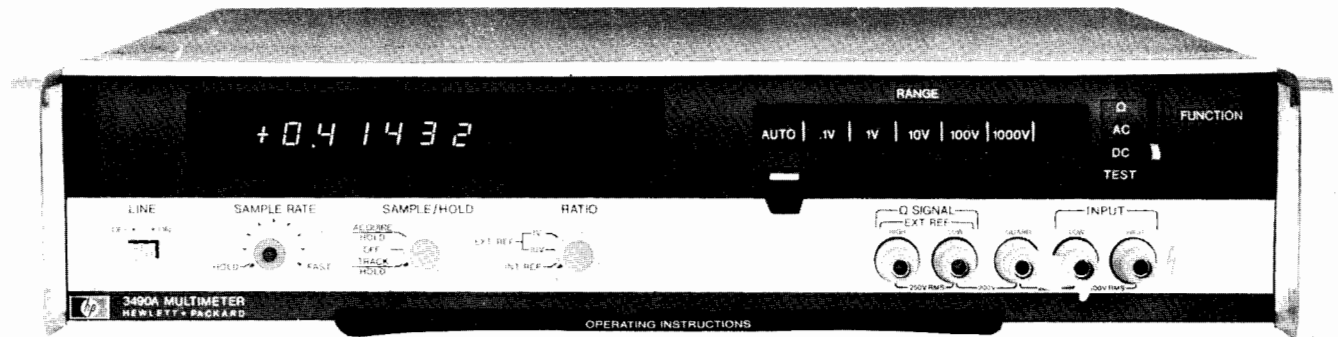

Description

Hewlett-Packard's Model 3490A Multimeter is a five-digit integrating digital voltmeter. The basic instrument measures dc voltages, ac voltages, and resistances. Additional measurement capability is achieved by the addition of low cost options.

HP's 3490A uses a dual slope integrating technique and is fully guarded, providing excellent noise immunity at five readings per second on all dc ranges. Ranging is automatic over all ranges on all functions. DC measurements can be made with $1\mu\text{V}$ resolution on the 100 mV range. AC voltage measurements can be made from 20 Hz to 250 kHz in four ranges. The 1 V range provides $10\mu\text{V}$ of ac voltage resolution. Resistance measurements are made with the 4-wire conversion technique, eliminating errors caused by test lead resistances. Six ranges, including the 100Ω range, are provided in the ohms functions.

Self-Test

At the flip of a switch, Hewlett-Packard's 3490A Digital Multimeter sequences itself through 10 tests that check timing signals and autoranging circuits, validate the performance of most logic-circuit IC's and check the six-digit LED display. These tests, and six others provided by six additional front-panel switches, cut calibration costs and ensure the DMM is ready to make accurate measurements.

DC Functions

The standard 3490A includes five ranges of dc measurement capability from 100 mV to 1000 V. Measurements are made from the front panel at precise five readings/s, and at slower rates, using digitally controlled sampled rate selector. High input resistance, $>10^{10}\Omega$ on 100 mV, 1 V, and 10 V range, assures accurate measurement of high impedance sources.

AC Functions

Four ranges of ac measurements are provided. The average ac value is accurately detected, and the rms value is displayed with five digits of resolution. Full autoranging, wide frequency response, and 20% overranging are designed-in features to permit easy operation.

Ohms

Six ohms ranges are standard, and all ranges provide true four-wire ohms measurement capability. Maximum current through the unknown is approximately 1 mA. Over-voltage protection for ohms sensing terminals insures maximum protection against inadvertent application of a high voltage to ohms terminals. Over-voltage protection is provided to 250 V and fuse protection to 1000 V.

Serviceability

HP's 3490A has been "designed for serviceability." Inside, the 3490's low parts density provides easy access for servicing. Test points and jumpers are keyed to detailed diagnostics.

Specifications

DC Voltage Ranges

Full range display: $\pm 1.00000\text{ V}$, $\pm 10.0000\text{ V}$, $\pm 100.000\text{ V}$, $\pm 1000.00\text{ V}$.

Overrange: 20% on all ranges except 1000 V range.

Range selection: manual, automatic, or remote (optional).

DC Voltage Performance

Accuracy \pm (% of reading + % of range)

		0.1 V Range		1 V to 1000 V Range	
		% rdg.	% rng.	%rdg.	%rng.
24 hrs	(23°C \pm 1°C)	$\pm(0.005 + 0.001)$		$\pm(0.004 + 0.001)$	
30 days	(23°C \pm 5°C)	$\pm(0.01 + 0.005)$		$\pm(0.008 + 0.002)$	
90 days	(23°C \pm 5°C)	$\pm(0.01 + 0.005)$		$\pm(0.01 + 0.002)$	
6 months	(23°C \pm 5°C)	$\pm(0.013 + 0.005)$		$\pm(0.013 + 0.002)$	
1 year	(23°C \pm 5°C)	$\pm(0.015 + 0.005)$		$\pm(0.015 + 0.002)$	

Notes:

1. On the 1000 V range, add 0.04 ppm/volt to the % of reading specification.

2. Thermal EMF's generated external to the DVM may be compensated to achieve the % of range accuracy specified by utilizing the rear panel zero adjust provided in the 3490A.

DC voltage input characteristics: fully guarded with 140 dB ECMR at dc and 60 Hz $\pm 0.1\%$ with 1 k Ω imbalance between guard and low.

Maximum Input Voltage

0.1 V to 1000 V ranges: $\pm 1500\text{ V}$ peak.

Guard to chassis: $\pm 500\text{ V}$ peak.

Guard to low: $\pm 200\text{ V}$ peak.

Input Resistance

0.1 V to 10 V ranges: $> 2 \times 10^{10}\Omega$. ($< 70\%$ R.H.).

100 V and 1000 V ranges: 10 M Ω $\pm 0.15\%$.

Maximum reading rate: 5 readings/s.

Normal mode rejection ratio: 50 Hz $\pm 0.1\%$; 60 Hz $\pm 0.1\%$; $> 50\text{ dB}$.

AC Voltage Ranges

Full range display: 1.00000 V, 10.0000 V, 100.000 V, 1000.00 V.

Overrange: 20% on all ranges except 1000 V range.

Range selection: manual, automatic, or remote (optional).

DIGITAL VOLTMETERS

Five-Digit Digital Multimeter with Self-Test

Model 3490A (Cont).



AC Voltage Performance

Accuracy \pm (% of reading + % of range)

		20 Hz-50 Hz	50 Hz-100 kHz	100 kHz-250 kHz
24 hrs	(23°C \pm 1°C)	$\pm(0.32 + 0.05)$	$\pm(0.09 + 0.025)$	$\pm(0.7 + 0.06)$
30 days	(23°C \pm 5°C)	$\pm(0.35 + 0.05)$	$\pm(0.1 + 0.025)$	$\pm(0.75 + 0.06)$
90 days	(23°C \pm 5°C)	$\pm(0.35 + 0.05)$	$\pm(0.1 + 0.025)$	$\pm(0.75 + 0.06)$
6 months	(23°C \pm 5°C)	$\pm(0.40 + 0.06)$	$\pm(0.1 + 0.03)$	$\pm(0.75 + 0.07)$
1 year	(23°C \pm 5°C)	$\pm(0.45 + 0.07)$	$\pm(0.12 + 0.035)$	$\pm(0.75 + 0.08)$

Notes:

- Guard must be connected to low.
- On the 1000 V range, add 0.01 ppm/(volt-kHz).
- Frequencies > 100 kHz specified on 1 V and 10 V ranges only.
- Specifications are for input levels above 1/100th of full scale.

AC Voltage Input Impedance

Without rear terminals: 2 M Ω \pm 1% shunted by < 65 pF.

With rear terminals: 2 M Ω \pm 1% shunted by < 90% pF.

AC voltage maximum reading rate: 1 reading/s.

AC voltage response time: < 1 s to within rated accuracy for a step input applied coincident with encoder trigger.

AC maximum input voltage: 1000 V rms; \pm 1500 V peak.

Ohms Ranges

Full range display: .100000 k Ω , 1.00000 k Ω , 10.0000 k Ω , 100.000 k Ω , 1000.00 k Ω , 10000.0 k Ω .

Overrange: 20% on all ranges.

Range selection: manual, automatic, or remote (optional).

Ohms Performance

Accuracy: \pm (% of reading + % of range)

Note: Thermal EMF's generated external to the DVM may be compensated to achieve the % of range accuracy specified by utilizing the rear panel zero adjust provided in HP's 3490A.

		0.1 k Ω		1 k Ω -100 k Ω		1000 k Ω		10,000 k Ω	
		% rdg.	% rng.	% rdg.	% rng.	% rdg.	% rng.	% rdg.	% rng.
24 hrs	(23°C \pm 1°C)	$\pm(0.006 + 0.001)$		$\pm(0.005 + 0.001)$		$\pm(0.007 + 0.001)$		$\pm(0.025 + 0.001)$	
30 days	(23°C \pm 5°C)	$\pm(0.012 + 0.005)$		$\pm(0.010 + 0.002)$		$\pm(0.012 + 0.002)$		$\pm(0.035 + 0.002)$	
90 days	(23°C \pm 5°C)	$\pm(0.012 + 0.005)$		$\pm(0.012 + 0.002)$		$\pm(0.015 + 0.002)$		$\pm(0.035 + 0.002)$	
6 months	(23°C \pm 5°C)	$\pm(0.015 + 0.005)$		$\pm(0.015 + 0.002)$		$\pm(0.020 + 0.002)$		$\pm(0.040 + 0.002)$	
1 year	(23°C \pm 5°C)	$\pm(0.018 + 0.005)$		$\pm(0.018 + 0.002)$		$\pm(0.025 + 0.002)$		$\pm(0.050 + 0.002)$	

Ohms Terminal Characteristics

Maximum voltage generated across unknown: 20 V for overload; 13 V for valid reading.

Ohms current thru unknown

0.1 k Ω to 10 k Ω range: 1 mA.

100 k Ω to 1000 k Ω range: 10 μ A.

10,000 k Ω range: 1 μ A.

Ohms overload protection

Nondestructive: 250 V rms.

Fuse destructive: \pm 1000 V peak.

Ohms maximum reading rate

0.1 k Ω to 100 k Ω range: 5 reading/s.

1000 k Ω range: 4 reading/s.

10,000 k Ω range: 2 reading/s.

General

Data Output (BCD), Option 021

Data output is 1-2-4-8 TTL output which is compatible with HP 5050B, and 5055A Digital Recorders. Either high true or low true logic code can be selected with an internal switch.

Storage temperature: -40°C to +75°C.

Remote Control, Option 022

The remote control option uses a low true logic (BCD type) code. Required voltage levels for input signal and output signal levels are listed below.

BCD and Remote Terminals

	High Level	Low Level
DVM Inputs	+3.9 V \pm 1.5 V, 100 μ A max	+0.3 \pm 0.3 V, 2 mA max
DVM Outputs	+3.9 V \pm 1.5 V, 400 μ A max	+0.3 V \pm 0.3V, 15 mA max

Operating temperature: 0°C to 50°C.

Warm-up time: one hour warm-up required to meet all specifications on the 0.1 V range and the 0.1 k Ω range. Thirty minutes warm-up required to meet all other specifications.

Humidity range: < 95% R.H., 0°C to 40°C.

Power: 100 V, 120 V, 220 V, 240 V \pm 5%, -10%, 48 Hz to 400 Hz line operation \leq 60 VA with all options.

Size: 85.7 mm H x 425.4 mm W x 466.7 mm D (3.4" x 16.75" x 18.4").

Weight: net, 9.38 kg (20.7 lb). Shipping, 11.79 kg (26 lb).

Options

Options	Price
020: BCD/remote expand, includes rear terminals in parallel	\$400
021: BCD*—full parallel, 1-2-4-8 code	\$375
022: Remote*—full parallel, 1-2-4-8 code	\$325
030: HP-IB remote control and data output. For cables see page 30.	\$1,300
040: Sample-and-hold*	\$650
045: Sample-and-hold (without Opt 020 or 030)	\$800
050 or 060: 50 Hz or 60 Hz operation	N/C
080: Three-wire ratio	\$325
908: Rack mounting kit	\$25

3490A Digital Multimeter (includes ac, dc, & ohms) **\$3,600**

Opt 050: Noise Rejection for 50 Hz

Opt 060: Noise Rejection for 60 Hz

*These options require BCD/Remote Expand Option 020 or HP-IB Opt 030.

Note: Rack mounting requires support in rear of instrument.

N/C
N/C

COMPONENT MEASUREMENT

General Information

C, R, L, D, Q, Z, θ and IC's

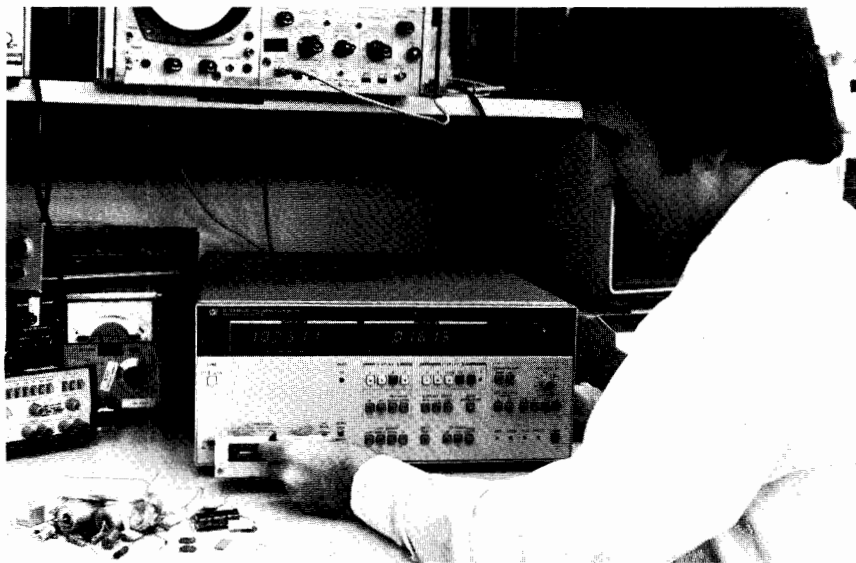

Instrument	Frequency				Q or		C in farads, L in henries or R in ohms							Basic Accuracy			Page
	DC Hz	1 kHz	1 MHz	1 GHz	10 ⁰	10 ³	10 ⁻¹⁵	10 ⁻¹²	10 ⁻⁹	10 ⁻⁶	10 ⁻³	10 ⁰	10 ³	0.1%	1%	10%	
Multi-frequency LCR Meter 4274A		•	•											•			110
Multi-frequency LCR Meter 4275A		•	•											•			110
RF Impedance Analyzer 4191A					10 ⁻³									•			114
LF Impedance Analyzer 4192A														•			116
Vector Z Meter 4193A															•		118
Digital LCR Meter 4261A		•												•			120
Digital LCR Meter 4262A		•	•											•			122
1 MHz LCR Meter 4271B														•			124
1 MHz Preset C Meter 4272A														•			125
1 kHz Preset C Meter 4273A														•			125
Q Meter 4342A															•		126
Miliohm Meter 4328A															•		127
LCR Meter 4332A														•			127
High Resistance Meter 4329A															•		128
Universal Bridge 4260A															•		129
Universal Bridge 4265B					10 ⁻³										•		129
Vector/Z/Meter 4800A															•		130
RF Vector/Z/Meter 4815A															•		130
pA Meter/DC Voltage Source 4140B*															•		132
Semiconductor/Component Test System 4061A															•		134
Digital IC Tester 5045A	Functional and DC Parameter measurements on TTL, CMOS, ECL, HTL, and DTL logic families.															136	

*I in amperes, V in volts; (V is test voltage).

Impedance $|Z|$, θ , C, R, L, D & Q

Hewlett Packard's family of component measurement instruments covers the impedance range from less than one milliohm to greater than 10^{16} ohms. Instruments range from the traditional manual null measurement technique to the completely automatic, microprocessor controlled, systems oriented type.

The basic characteristics of each instrument are summarized in the selection guide on the preceding page. This guide is convenient for selecting the most suitable instrument for a particular application or for considering trade-offs of key characteristics.

Impedance Considerations

Impedance measuring instruments can be categorized, according to the technique used, into the bridge, voltage/current and Q methods. In the bridge technique, circuit conditioning required to achieve a balance or null condition is detected and processed to indicate the measured value. The voltage/current method essentially uses Ohm's Law in that a constant voltage or current is applied to the unknown and the converse current or voltage is indicative of the unknown value. The Q method utilizes unique characteristics of the series resonant circuit to determine Q, and indirectly L, C and R.

Traditionally, the bridge has been the most accurate measurement technique. Two examples are the low-cost, manual HP 4265B Universal Bridge and the semi-automatic HP 4260A Universal Bridge. Today's technology yields automatic, digital readout bridges with accuracy exceeding the less sophisticated manual bridges.

Several fully automatic digital bridges are available from Hewlett-Packard, each with special features. The HP 4271B 1 MHz LCR Meter uses a state-of-the-art four terminal pair arrangement to eliminate the mutual inductance of the test leads—a principle consideration at 1 MHz. The HP 4272A 1 MHz Preset C Meter has an internal comparator for automatic sorting.

In the past, the voltage/current technique utilized analog meter readouts for speed and convenience, but offered less accuracy than the bridge method. With recent advances in technology, this is no longer the case. The new fully automatic digital instruments using the voltage/current method offer accuracy exceeding all but the most sophisticated manual bridges.

The first of these instruments introduced by Hewlett-Packard was the 4261A. It offers fully automatic L, C, R and D measurements at two test frequencies with excellent accuracy. The HP 4262A is the first of a new generation of microprocessor-based instruments, featuring three test frequencies and automatic self-test capability.

New Generation Component Measurements

Many of these measurements have been either not practical, very difficult, or very cost-

ly to make with earlier instruments that were designed to make measurements only under relatively limited test conditions. However, Hewlett-Packard now offers a new generation of instruments to change the measuring concept of evaluating electronic components, devices and circuits—that is, "testing and evaluating under actual working conditions."

The addition of the HP 4274A and 4275A will allow the user to test components under actual operating conditions. Both instruments feature variable test signal levels, ten spot frequencies, self test capability, digital offset to compensate for test leads and fixtures, and vector/phase angle measurements.

Impedance analysis and network analysis can be performed accurately and efficiently using the HP Model 4191A RF Impedance Analyzer and the new HP Model 4192A LF Impedance Analyzer.

In the frequency range of 1 MHz to 1000 MHz, the 4191A measures 14 parameters including $|Z|$, $|Y|$, θ , R, X, G, B, L, C, D, and Q, reflection coefficient $|\Gamma|$, $|\Gamma_x|$, and $|\Gamma_y|$ plus deviation Δ and $\Delta\%$ for all parameters. The 4192A measures all the preceding parameters plus Group Delay in the frequency range from 5 Hz to 13 MHz.

Both 4191A and 4192A have built-in frequency synthesizers and dc bias sources, including internal sweep of both frequency and bias voltage. Basic measuring accuracy for the 4191A (1 MHz to 1000 MHz) is 1%. Basic accuracy for the 4192A (5 Hz to 13 MHz) is 0.3%.

The addition of the HP 4193A enables in-circuit measurements of impedance magnitude and phase. The 4193A features a built-in 4 digit synthesizer, sweepable from 400 kHz to 110 MHz. This also offers in-circuit and component impedance evaluation at actual operating frequencies.

Semiconductor Measurements

The 4140B pA Meter/DC Voltage Source is the latest addition to the new generation of component measuring instruments for doing basic DC characteristics measurements such as leakage current, current-voltage characteristics, quasi-static C-V measurements and those others especially required by the semiconductor industry for new device development and for improvement of production yields.

The 4140B is also usable for making measurements on electric components and equipment such as for measuring leakage current or insulation resistance to improve product reliability.

Generally, in low current measurements, there have been many problems—noise, drift, measuring speed and accuracy which have been preventing reliable results.

The 4140B consists of a very stable picoampere meter with a synchronized, dual programmable DC voltage supply— V_A and V_B (V_A includes staircase capability and ramp voltage generation). The instrument is designed to solve the measurement problems described above and specifically to facilitate making them more easily.

Integration into HP-IB System

Adding the HP-IB option to a component measuring instrument enables the instrument to be incorporated into an HP-IB system. This permits high speed measurement of many components along with arithmetic processing of the data and allows a remarkable efficiency increase to be realized in the production line testing of discrete components, in quality assurance tests, or in laboratory evaluations.

For more comprehensive semiconductor measurement, Hewlett-Packard has recently introduced the Model 4061A Semiconductor/Component Test System. The 4061A is a dedicated HP-IB system that performs efficient, automatic evaluation of the fundamental characteristics of semiconductor and electronic components. The 4061A is especially useful for new component/material development, quality control, and in the early stages of semiconductor manufacture, for monitoring and controlling the wafer process.

A wide range of characteristics measurements can be done, including doping profile, surface charge, density, minority carrier lifetime and threshold voltage. The 4061A can also perform analysis of more conventional impedance characteristics of electronic components. Software for seven typical applications are provided with the system.

The 4061A employs a unique switching sub-system that controls DUT connection between the LCR meter and pA Meter. This insures that both impedance and current characteristics can be measured without changing the system set-up. The 4061A is flexible enough in both hardware and software to allow expansion and increased data processing capabilities.

Summary

To assist in the selection of an impedance meter suitable for your needs, the following guidelines may be used:

- (1) Choose an instrument which measures the device under test (DUT) under the identical conditions (frequency, signal level, bias, . . .) as its intended use.
- (2) Consider the environmental parameters (lead resistance and inductance, stray capacitance, temperature variations, . . .) that will affect your measurement and choose a measurement technique that will tend to counteract them.
- (3) Then select the instrument with the broadest measurement capability within accuracy and cost constraints.

Hewlett-Packard's impedance measuring instruments have been used in numerous diverse applications. If you have an unusual application or need assistance, contact your nearest Hewlett-Packard sales office for information.

COMPONENT MEASUREMENT

Multi-Frequency LCR Meters

Models 4274A & 4275A

- Test frequencies - 100 Hz to 100 kHz
- Test signal level - 1 mV to 5 Vrms
- High Resolution - 5½ digit: D=0.00001
- Measure L/C - D/Q/ESR/G; $|Z| - \theta$, R-X/B/L/C; $\Delta LCRZ$, $\Delta\%$
- 0.1% basic accuracy

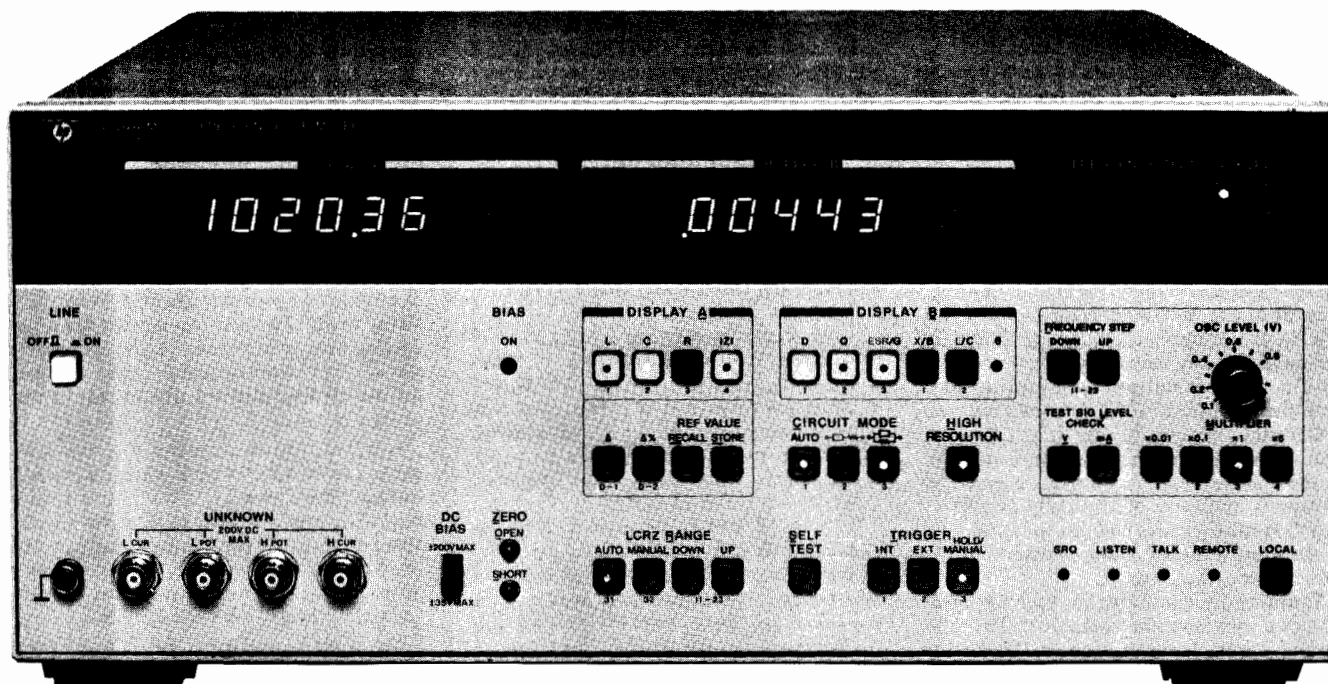

4274A



Description

The 4274A and 4275A Multi-frequency LCR Meters are the most recent additions to Hewlett-Packard's new generation of micro-processor-based impedance measuring instrumentation. Both instruments offer a new measuring concept for the evaluation of LCR components, complex components, electronic circuits "tested under actual working conditions", and semiconductor materials. A measurement under conditions similar to the intended use contributes to the improvements in quality and reliability of electronic components, devices and circuits.

Multi-Frequency Capability

To insure the high reliability in circuits and devices, it is most important that they be tested and evaluated at test signals similar to those of actual operating conditions.

The 4274A covers the wide frequency range of 100 Hz to 100 kHz in 11 spot frequencies and the 4275A has 10 spot frequencies from 10 kHz to 10 MHz, in 1-2-4 step sequence with 1-3-5 as an option. This feature produces the frequency characteristics of components or devices. In addition, two optional special frequencies (for example: 455 kHz and 10.7 MHz) are available within the frequency range of each instrument. This wide frequency range selection offers evaluation of circuit design with a continuously variable test signal over the range of 1 mV to 5 Vrms (to 1 Vrm for the 4275A), and with internal dc bias optionally available with 1 mV maximum resolution. The test voltage or current values can be monitored on the 3-digit display for accurately setting the actual conditions under which the device-under-test will operate.

Multi-Parameter Measurements

The 4274A and 4275A measure equivalent series resistance (ESR), impedance ($|Z|$), phase angle (θ), reactance (X), susceptance (B), and conductance (G), in addition to the conventional L,C,R,D and Q parameters in certain combinations with a dual 5½ digit display, and an HP-IB option for systems integration.

This wide selection of 11 parameters provides for more accurate evaluation of electronic materials or components with high measurement speed for most needed combined parameters; for example, the C-G measurement of semiconductors, an R-X measurement in circuit design, or the C-ESR or $|Z| - \theta$ measurement of tantalum capacitors.

In addition, a deviation measurement capability ($\Delta, \Delta\%$) for the L.C.R. and $|Z|$ functions displays the difference between the actual value and a stored reference, either as a difference value or in percent. Deviation applications include, for example, a temperature dependence measurement of devices in environmental tests.

Reliable Measurements With 5½ Digit Resolution

The 4274A and 4275A measure only the value of the component and/or device under test, with 5½ resolution and 0.1% basic accuracy by reducing the possibility of errors due to self or mutual inductance, stray capacitance and/or residual inductance in the test leads or test fixture used. This measurement is obtained by a state-of-the-art four terminal pair configuration and a built-in automatic ZERO-offset capability to compensate for these errors.

COMPONENT MEASUREMENT

Multi-Frequency LCR Meters

Models 4274A & 4275A



- Test frequencies - 10 kHz to 10 MHz
- Test signal level - 1 mV to 1 Vrms
- 0.1% basic accuracy

- High Resolution - 5½ digit; D=0.00001
- Measure L/C - D/Q/ESR/G; |Z| - θ , R-X/B/L/C; Δ LCRZ, $\Delta\%$

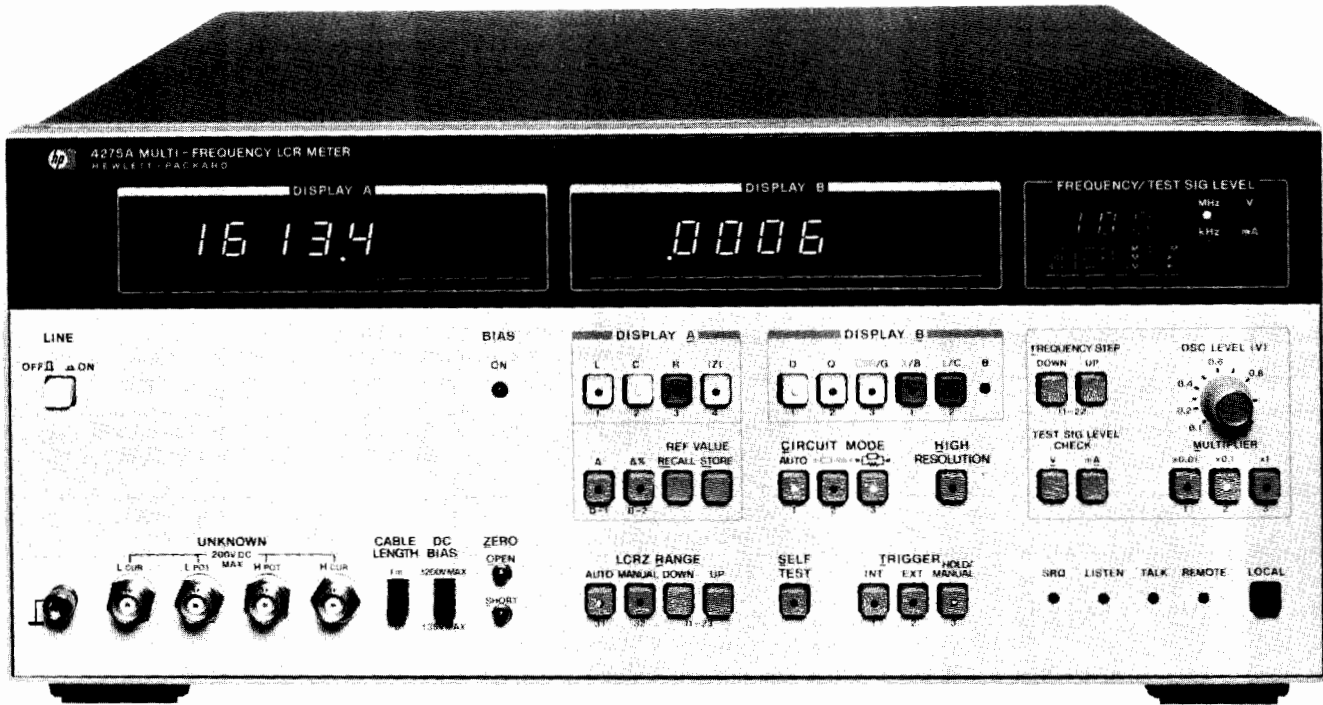

4275A



The fast measurement speed, high resolution, and high accuracy can make major contributions for the component manufacturer and user who is concerned about reducing his costs, improving quality, and throughput efficiency. In these areas, the 4274A and the 4275A are ideal for D-measurements of film capacitors or insulation material (with the high resolution of 0.00001), the C-G measurements of semiconductors (with maximum resolutions of 0.001 pF, 0.1 nS, respectively), and for the low impedance measurement of aluminum electrolytic capacitors (with a maximum resolution of 0.001 m Ω).

Automatic Semiconductor and Component Measurements With HP-IB

Integrating the 4274A and the 4275A into an HP-IB controlled system is an excellent method for improving efficiency and cost savings both in the laboratory and on the production line. These automatic measurement systems are assembled by connecting the HP-IB cables between the instruments to be utilized for a specific task.

A system built around the 4274A and/or 4275A allows the user to obtain useful data for many diverse applications. For example, the evaluation of semiconductors based on the frequency dependence of its C-V characteristics that requires a wide range and fast measurement speeds is easily accomplished with these instruments. The four-terminal pair input configuration and the automatic zero offset capability insures that the measured data is accurate, even in a systems environment.

Sample Applications Semiconductor Measurements

The evaluation of a semiconductor can be done with a C-V or G-V measurement with the multi-spot frequencies featured in the 4274A

and 4275A, (with C resolution of 0.001 pF and G resolution of 0.1 nS), their two programmable bias sources (maximum resolution 1 mV) and their continuously variable test signal levels (from 1 mVrms).

Of significant use is the evaluation of the doping process and the measurement of the characteristics of MOS or bipolar semiconductor materials which employ a C or G measurement with varying dc bias voltage.

A sample plot of a semiconductor measurement is shown in the figure below. Such measurements at high speed can offer high reliability and high throughput efficiency in the semiconductor manufacturing processes.

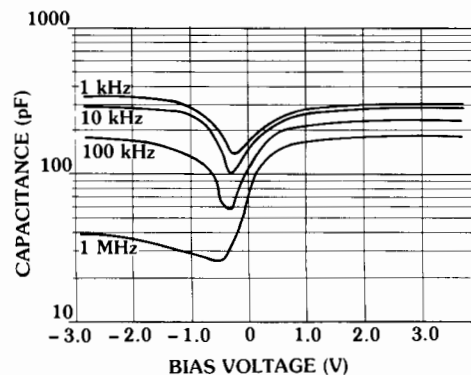

COMPONENT MEASUREMENT

Multi-Frequency LCR Meters

Models 4274A & 4275A (Cont.)

Common Specifications (4274A & 4275A)

Parameters measured:

L: inductance C: capacitance	Q: =1/D ESR: equivalent series resistance	θ: phase angle Δ: deviation for L, C, R, Z, Δ%: % of deviation Test frequency Test signal level (voltage or current)
R: resistance Z: impedance D: dissipation factor	G: conductance X: reactance B: susceptance	

Parameter combinations:

Display A	Display B	
L	D / Q / ESR	D / Q / G
C		
R	X / L	B / C
Z	θ	

Measurement frequencies, test signal levels, and full scale range:

MODEL	4274A	4275A	
Measurement frequencies	100Hz-100kHz, 11 spots (100Hz, 120Hz, 200Hz, 400Hz, 1kHz, 2kHz, 4kHz, 10kHz, 20kHz, 40kHz, 100kHz; ±0.01%)	10kHz-10MHz, 10 spots (10kHz, 20kHz, 40kHz, 100kHz, 200kHz, 400kHz, 1MHz, 2MHz, 4MHz, 10MHz; ±0.01%)	
Test signal levels	4-ranges (1 mVrms-5 Vrms) continuously variable	3-ranges (1 mVrms-1 Vrms) continuously variable	
Full scale range	L C R, Z , ESR, & X D Q (1/D) G & B θ	100.00nH - 1000.0H 1.0000pF - 1.00F 100.00mΩ - 10.000MΩ 0.00001 - 9.9999 0.01 - 9900 1.0000μS - 100.00S 0 - ±180°	100.00nH - 10.00H 1.0000pF - 100.00μF 1.0000Ω - 10.000MΩ 0.00001 - 9.9999 .01 - 9900 1.0000μS - 10.00S 0 - ±180°

Accuracy (4274A only): Typical C-D, L-D, R-X and |Z|-θ measurement accuracy values are given below.

Displays: Dual 5½-digit and single 3-digit; maximum display 199999 (full scale and overrange in high resolution mode), and 4½-digit; maximum display 19999 in normal mode. (Number of digits depends on measurement frequency, test level, and range).

Circuit modes: Series equivalent circuit and parallel equivalent circuit. Automatic selection available in AUTO mode.

Deviation measurement: Difference between recallable stored reference and displayed is deviation value (count or percent).

Display range: -199999 to +199999 counts in AUTO range. -19999 to +19999 counts in MANUAL range (the sample should be measurable at the selected range). % Display range: -199.99% to +199.99%

Ranging: AUTO or MANUAL (UP/DOWN)

Trigger: Internal, External or Manual.

Measurement terminals: Four-terminal pair with guard.

Auto zero adjustment: Automatic normalization of the readout offset due to residuals of the test fixture by pushbutton operation.

Normalization range: C < 20 pF, L < 2000 nH, R < 0.5Ω, G < 5 μS.

Self test: Automatic operational verification check indicates pass or fail condition.

HP-IB data output and remote control: Standard.

Memory back-up for storing measurement conditions: Standard.

Range: full scale range, accuracy: % of reading + counts (D: accuracy: % of reading + absolute D value + count)

FREQUENCY RANGE	C-D/Q	L-D/Q	R-X	Z -θ
	D-range: 0.00001-9.9999 Q-range: 0.01-9900 (=1/D) (C & D accuracies apply only when C: full scale and D: ≤ 0.1)	D-range: 0.00001-9.9999 Q-range: 0.01-9900 (=1/D) (L & D accuracies apply only when L: full scale and D: ≤ 0.1)	(R accuracies apply only when R: full scale) (X accuracies apply only when R: 1/10 of full scale and X: full scale)	θ-range: -180° - +180.00° (Z & θ accuracies apply only when Z : full scale)
100Hz 120Hz	C: 1000pF-1000mF, 0.1% + 3 D: 0.33% + 0.0008 + 1	L: 100μH-10kH, 0.1% + 3 D: 0.33% + 0.0013 + 1	R: 100mΩ-10MΩ, 0.1% + 3 X: 100mΩ-10MΩ, 0.1% + 13	Z : 100mΩ-10MΩ, 0.1% + 3 θ: ±0.1°
200Hz	C: 1000pF-1000mF, 0.1% + 2 D: 0.32% + 0.0007 + 1	L: 100μH-10kH, 0.1% + 3 D: 0.32% + 0.0012 + 1	R: 100mΩ-10MΩ, 0.1% + 3 X: 100mΩ-10MΩ, 0.1% + 13	Z : 100mΩ-10MΩ, 0.1% + 3 θ: ±0.1°
400Hz	C: 100pF-100mF, 0.14% + 1 D: 0.34% + 0.0013 + 1	L: 100μH-10kH, 0.1% + 3 D: 0.31% + 0.0011 + 1	R: 100mΩ-10MΩ, 0.1% + 3 X: 100mΩ-10MΩ, 0.1% + 13	Z : 100mΩ-10MΩ, 0.1% + 3 θ: ±0.1°
1kHz	C: 100pF-100mF, 0.1% + 3 D: 0.33% + 0.0008 + 1	L: 10μH-1000H, 0.1% + 3 D: 0.33% + 0.0013 + 1	R: 100mΩ-10MΩ, 0.1% + 3 X: 100mΩ-10MΩ, 0.1% + 13	Z : 100mΩ-10MΩ, 0.1% + 3 θ: ±0.1°
2kHz	C: 100pF-100mF, 0.1% + 2 D: 0.32% + 0.0007 + 1	L: 10μH-1000H, 0.1% + 3 D: 0.32% + 0.0012 + 1	R: 100mΩ-10MΩ, 0.1% + 3 X: 100mΩ-10MΩ, 0.1% + 13	Z : 100mΩ-10MΩ, 0.1% + 3 θ: ±0.1°
4kHz	C: 10pF-10mF, 0.14% + 1 D: 0.34% + 0.0013 + 1	L: 10μH-1000H, 0.1% + 3 D: 0.31% + 0.0011 + 1	R: 100mΩ-10MΩ, 0.1% + 3 X: 100mΩ-10MΩ, 0.1% + 13	Z : 100mΩ-10MΩ, 0.1% + 3 θ: ±0.1°
10kHz	C: 10pF-10mF, 0.1% + 3 D: 0.33% + 0.0008 + 1	L: 1μH-100H, 0.1% + 3 D: 0.33% + 0.0013 + 1	R: 100mΩ-10MΩ, 0.1% + 3 X: 100mΩ-10MΩ, 0.1% + 13	Z : 100mΩ-10MΩ, 0.1% + 3 θ: ±0.1°
20kHz	C: 10pF-10mF, 0.1% + 2 D: 0.32% + 0.0007 + 1	L: 1μH-100H, 0.1% + 3 D: 0.32% + 0.0012 + 1	R: 100mΩ-10MΩ, 0.1% + 3 X: 100mΩ-10MΩ, 0.1% + 13	Z : 100mΩ-10MΩ, 0.1% + 3 θ: ±0.1°
40kHz	C: 1pF-1000μF, 0.14% + 1 D: 0.34% + 0.0013 + 1	L: 1μH-100H, 0.1% + 3 D: 0.31% + 0.0011 + 1	R: 100mΩ-10MΩ, 0.1% + 3 X: 100mΩ-10MΩ, 0.1% + 13	Z : 100mΩ-10MΩ, 0.1% + 3 θ: ±0.1°
100kHz	C: 1pF-1000μF, 0.1% + 3 D: 0.33% + 0.0008 + 1	L: 100nH-10H, 0.1% + 3 D: 0.33% + 0.0013 + 1	R: 100mΩ-10MΩ, 0.1% + 3 X: 100mΩ-10MΩ, 0.1% + 13	Z : 100mΩ-10MΩ, 0.1% + 3 θ: ±0.1°

(Conditions: Warm-up time ≥ 30 minutes, environment temperature: 23°C ± 5°C) Refer to technical data sheet for accuracy details.



Accuracy (4725A only): Typical C-D, L-D, R-X and $|Z|-\theta$ measurement accuracy values are given below.

Range: full scale range, accuracy: % of reading + counts (D accuracy: % of reading + absolute D value + count)

Frequency Range	C-D/Q	L-D/Q	R-X	$ Z -\theta$
	D-range: 0.00001 - 9.9999 Q-range: 0.01-9900 (= 1/D) (C & D accuracies apply only when C: full scale and D: ≤ 0.1)	D-range: 0.00001 - 9.9999 Q-range: 0.01 = 9900 (= 1/D) (L & D accuracies apply only when L: full scale and D: ≤ 0.1)	(R accuracies apply only when R: full scale) (X accuracies apply only when R: 1/10 of full scale and X: full scale)	θ -range: $-180.00^\circ - +180.00^\circ$ (Z & θ accuracies apply only when Z: full scale)
10 kHz	C: 10 pF - 100 μ F, 0.1% + 3 D: 0.33% + 0.008 + 1	L: 10 μ H - 100H, 0.1% + 3 D: 0.33% + 0.0013 + 1	R: 1000 m Ω - 10 M Ω , 0.1% + 3 X: 1000 m Ω - 10 M Ω , 0.1% + 13	$ Z $: 1000 M Ω - 10 m Ω , 0.1% + 3 θ : $\pm 0.1^\circ$
20 kHz	C: 10 pF - 100 μ F, 0.1% + 2 D: 0.32% + 0.0007 + 1	L: 10 μ H - 100 H, 0.1% + 3 D: 0.32% + 0.0012 + 1	R: 1000 m Ω - 10 M Ω , 0.1% + 3 X: 1000 m Ω - 10 M Ω , 0.1% + 13	$ Z $: 1000 M Ω - 10 m Ω , 0.1% + 3 θ : $\pm 0.1^\circ$
40 kHz	C: 1 pF - 10 μ F, 0.14% + 1 D: 0.34% + 0.0009 + 1	L: 10 μ H - 100 H, 0.1% + 3 D: 0.31% + 0.0011 + 1	R: 1000 m Ω - 10 M Ω , 0.1% + 3 X: 1000 m Ω - 10 M Ω , 0.1% + 13	$ Z $: 1000 M Ω - 10 m Ω , 0.1% + 3 θ : $\pm 0.1^\circ$
100 kHz	C: 1 pF - 10 μ F, 0.1% + 3 D: 0.33% + 0.0008 + 1	L: 1 μ H - 10 H, 0.1% + 3 D: 0.33% + 0.0013 + 1	R: 1000 m Ω - 10 M Ω , 0.1% + 3 X: 1000 m Ω - 10 M Ω , 0.1% + 13	$ Z $: 1000 M Ω - 10 m Ω , 0.1% + 3 θ : $\pm 0.1^\circ$
200 kHz	C: 10 pF - 10 μ F, 0.1% + 2 D: 0.32% + 0.0007 + 1	L: 1 μ H - 1000 mH, 0.2% + 3 D: 0.53% + 0.0023 + 1	R: 1000 m Ω - 1 M Ω , 0.2% + 3 X: 1000 m Ω - 1 M Ω , 0.2% + 13	$ Z $: 1000 M Ω - 1 m Ω , 0.2% + 3 θ : $\pm 0.1^\circ$
400 kHz	C: 1 pF - 1000 nF, 0.14% + 1 D: 0.34% + 0.0009 + 1	L: 1 μ H - 1000 mH, 0.2% + 3 D: 0.51% + 0.0021 + 1	R: 1000 m Ω - 1 M Ω , 0.2% + 3 X: 1000 m Ω - 1 M Ω , 0.2% + 13	$ Z $: 1000 M Ω - 1 m Ω , 0.2% + 3 θ : $\pm 0.1^\circ$
1 MHz	C: 1 pF - 1000 nF, 0.1% + 3 D: 0.33% + 0.0008 + 1	L: 100 nH - 100 mH, 0.2% + 3 D: 0.55% + 0.0025 + 1	R: 1000 m Ω - 1 M Ω , 0.2% + 3 X: 1000 m Ω - 1 M Ω , 0.2% + 13	$ Z $: 1000 M Ω - 1 m Ω , 0.2% + 3 θ : $\pm 0.1^\circ$
2 MHz	C: 10 pF - 100 nF, 0.3% + 3 D: 0.55% + 0.0025 + 1	L: 1 μ H - 10 mH, 0.5% + 5 D: 1.0% + 0.0033 + 1	R: 10 Ω - 100 k Ω , 0.5% + 5 X: 10 Ω - 100 k Ω , 0.5% + 15	$ Z $: 10 Ω - 100 k Ω , 0.5% + 5 θ : $\pm 0.2^\circ$
4 MHz	C: 1 pF - 10 nF, 1% + 20 + 0.002 pF D: 3.3% + 0.01 + 1	L: 1 μ H - 10 mH, 1% + 5 D: 2.0% + 0.0063 + 1	R: 10 Ω - 100 k Ω , 2% + 7 X: 10 Ω - 100 k Ω , 2% + 105	$ Z $: 10 Ω - 100 k Ω , 2% + 7 θ : $\pm 0.8^\circ$
10 MHz	C: 1 pF - 10 nF, 2% + 20 + 0.002 pF D: 4% + 0.011 + 1	L: 100 nH - 1 mH, 2% + 7 D: 3.1% + 0.002 + 1	R: 10 Ω - 100 k Ω , 2% + 7 X: 10 Ω - 100 k Ω , 2% + 105	$ Z $: 10 Ω - 100 k Ω , 2% + 7 θ : $\pm 0.8^\circ$

(Conditions: Warm-up time ≥ 30 minutsa, environment temperature: $23^\circ\text{C} \pm 5^\circ\text{C}$) Refer to technical data sheet for accuracy details.

General Information

Test signal level monitor:

Model	Range		Accuracy
	Voltage	Current	
4274A	0.001 V - 5.00 Vrms	0.001 mA - 100 mArms	\pm (3% of reading + 1 count)
4275A	0.001 V - 1.00 Vrms	0.001 mA - 10.0 mArms	\pm (3% of reading + 1 count) at < 1 MHz \pm (10% of reading + 2 counts) at ≥ 1 MHz

Measurement time: (typical) 140-180 ms (> 1 kHz); 140-210 ms ≤ 1 kHz (Measurement time depends on range, sample value and off-set adjustment value).

Z - θ measurement time: 170-210 ms > 1 kHz; 170-240 ms ≤ 1 kHz.

High resolution mode: Approximately 8 times the normal measurement time.

Auto ranging time: 100 ms - 300 ms per range change.

Options

Opt 001: 0 to ± 35 internal dc bias

Range	Steps	Accuracy
\pm (.000 - 999) V	1 mV	\pm (0.5% of reading + 1 mV)
\pm (1.00 - 9.99)	10 mV	\pm (0.5% of reading + 2 mV)
\pm (10.0 - 35.0)	0.1 V	\pm (0.5% of reading + 20 mV)

Control: 16023B DC Bias Controller or remote control with HP-IB (opt 101)

Opt 002: 0 - ± 99.9 V internal dc bias (for C $\leq 0.1 \mu\text{F}$)

Range: \pm (00.0 - 99.9) V, 0.1 V steps

Accuracy: \pm (2% of reading + 40 mV)

Control: Same as Opt 001

External dc bias: ± 200 V maximum.

Bias monitor: Rear panel BNC connector monitors internal or external input bias.

Opt 004: Frequency steps in 1-3-5 sequence.

Special options: Up to two additional test frequencies can be added in the frequency range of the 4274A (100 Hz to 100 kHz) or 4275A (10 kHz to 10.7 MHz). The following special test frequencies are available and others are available on request:

Option number	Frequency	Option number	Frequency
F01	15.7 kHz	F14	25.2 kHz
F02	32.8 kHz	F15	79.6 kHz
F03	455 kHz	F16	252 kHz
F04	3.58 MHz	F17	796 kHz
F05	4.19 MHz	F18	2.52 MHz
F06	10.7 MHz	F19	7.96 MHz
F11	15.75 kHz	F21	15.625 kHz
F13	62.5 kHz	F25	63.18 kHz

Accessories

16047A: Direct coupled test fixture. Furnished accessory with the 4274A and 4275A.

16023B: DC Bias Controller, for control of dc bias Opt 001 or 002 Internal Bias Supply when HP-IB option is not installed. Control range 0 to ± 99.9 V by setting thumbwheel switch. \$320

16034B: Test Fixture for chip components \$340

16047B: Test Fixture with Safety Cover \$640

16047C: Test Fixture for high frequencies \$280

16048A: Test leads, BNC \$275

16048B: Test leads, RF miniature \$27.5

16048C: Test leads with Alligator Clips \$35.0

16380A: Standard Air Capacitor Set, includes 1 pF, 10 pF, 100 pF and 1000 pF standard capacitors usable to 10 MHz. \$2660

Options

Opt 001: 0 to ± 35 internal dc bias, max resolution; 1 mV steps \$745

Opt 002: 0 to ± 99.9 V internal dc bias, resolution: 100 mV steps. \$690

Opt 004: Frequency steps in 1-3-5 sequence N/C

Opt F01-F27: Special test frequencies (each) \$460

Ordering Information

4274A 100 Hz - 100 kHz Multi-Frequency LCR Meter \$8525

4275A 10 kHz - 10 MHz Multi-Frequency LCR Meter \$9310

Price

COMPONENT MEASUREMENT

RF Impedance Analyzer

Model 4191A

- 1-1000 MHz variable test frequency with sweep capability
- Direct reading of $|Z| - \theta$, $|Y| - \theta$, $|\Gamma| - \theta$;
 $L \cdot C - R \cdot G \cdot D \cdot Q$
 $R - X, G - B, \Gamma_x - \Gamma_y$
- High resolution—4½ digit max
- Wide measuring range—1 m Ω – 100 k Ω ($|Z|$)
- Versatile easy-to-use test fixtures

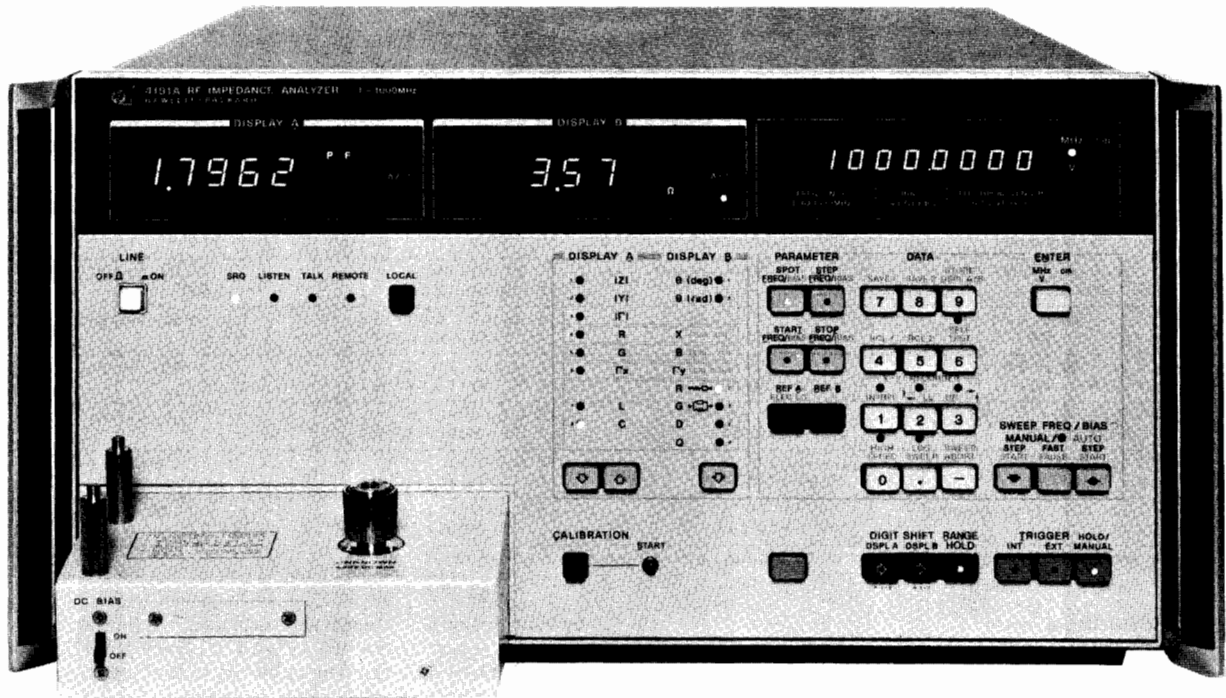

4191A (Shown with Opt 907 Handles)



Description

The HP Model 4191A RF Impedance Analyzer measures 14 parameters with a maximum resolution of 4½ digits. The internal synthesizer provides variable frequencies from 1 MHz through 1000 MHz covering the UHF, VHF and video bands with automatic sweep capability. An internal dc bias supply with auto sweep function covers the voltage range of ± 40 V in 10 mV steps.

The 4191A permits reliable measurements over a wide measuring range. Its outstanding repeatability, frequency response and accuracy are made possible by unique error correction capability and specially designed test fixtures. These features allow the 4191A to be used in evaluation of electronic materials, components and circuitry.

The internal synthesizer provides a maximum resolution of 100 Hz (Opt 002) with an accuracy of 3 ppm, allowing small changes in the resonant frequency of the device under test to be easily detected. The swept frequency capability aids in the analysis of frequency characteristics of the device.

Two complete front panel settings (parameter selection and the sweep control) can be stored in a non-volatile memory and recalled at any time with a single key operation. This, together with the standard HP-IB interface, makes the 4191A extremely efficient either as a stand-alone or systems instrument.

These unique features permit very wide applications in: (1) semiconductor testing such as surface state evaluation at high frequencies (C-V/G-V and conductance G/ω) characteristics, and the input/output impedance evaluation of diodes and transistors, (2) resonator, filter, and magnetic and dielectric materials testing, (3) evaluation of LCR components such as high frequency chip and leaded components, and (4) testing of communications related components such as cables, connectors, etc.

Specifications

Parameter measured: $|Z| - \theta$, $|Y| - \theta$, $|\Gamma| - \theta$
 $R - X, G - B, \Gamma_x - \Gamma_y$
 $L - R \cdot G \cdot D \cdot Q, C - R \cdot G \cdot D \cdot Q$

Display: 4½ digit, max display 19999 counts
Deviation measurement (deviation from stored reference):
 Δ : -19999 to +19999 counts
 $\Delta\%$: -1999.9 to +1999.9%

Measuring signal ($23 \pm 5^\circ\text{C}$):
Frequency range: 1 MHz to 1000 MHz
Frequency step: Standard: 100 kHz, 1-500 MHz
 200 kHz, 500-1000 MHz
 Opt 002: 100 Hz, 1-500 MHz
 200 Hz, 500-1000 MHz

Frequency accuracy: ± 3 ppm
Signal level (into 50 Ω): -20 ± 3 dBm
Frequency control: spot and swept

Measuring mode:
Spot measurement: at specific frequency (or dc bias)
Swept measurement: manual or automatic sweep from start to stop frequency (or dc bias) at step frequency (or dc bias) rate in linear or logarithmic form.

Auto calibration:
 Automatic error compensation referenced to connected terminations (0 Ω , 50 Ω , 0 S)
Calibration frequency: 51 frequencies between start and stop frequencies.

Electrical length compensation: automatic compensation for electrical length of test fixtures.

Compensating range: 0 to 99.99 cm.

DC Bias:

Internal DC Bias

Voltage range: -40 to +40 V, 10 mV step

Setting accuracy: 0.1% of setting +10 mV

Bias control: spot and swept

External DC Bias

Voltage range: -40 to +40 V

Max allowable current: 100 mA

Key status memory: 2 sets of measuring conditions can be stored and recalled at any time. These conditions are kept in storage even when LINE is turned off.

Ranging: Auto/Range hold

Trigger: Internal, External or Manual

Self-Test: Automatic internal program test

HP-IB Data output and remote control: Standard

Measuring Range, Resolution and Accuracy:

Specified at APC-7 UNKNOWN connector for reflect coefficient measurement at measuring frequency and ambient temperature (0 - 55°C) where calibration is performed after the warm-up time of 40 minutes. Refer to General Information for temperature coefficient and typical measuring range/resolution and accuracies of other measuring parameters (see data sheet for detailed specifications).

$|\Gamma| - \Theta / \Gamma_x - \Gamma_y$ Measurement

Measuring range:

$|\Gamma|, \Gamma_x, \Gamma_y$: 0.0001 to 1.0000

Θ : 0° to ±180.00° (0 to ±π rad.)

$|\Gamma|, \Gamma_x, \Gamma_y$ resolution: 0.0001

$|\Gamma|, \Gamma_x, \Gamma_y$ Accuracy (see graph below):

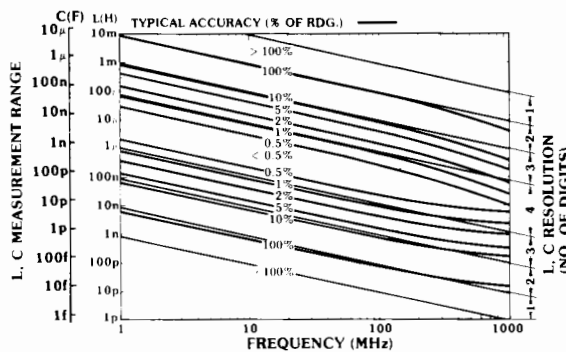
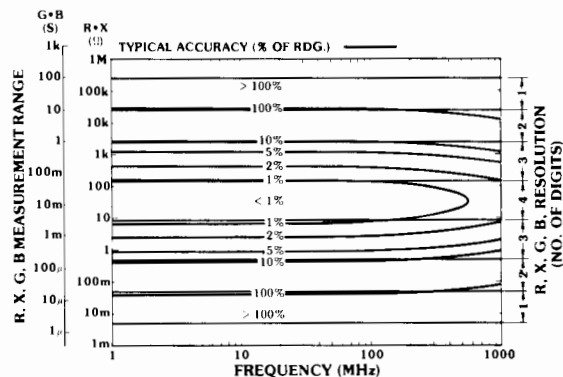
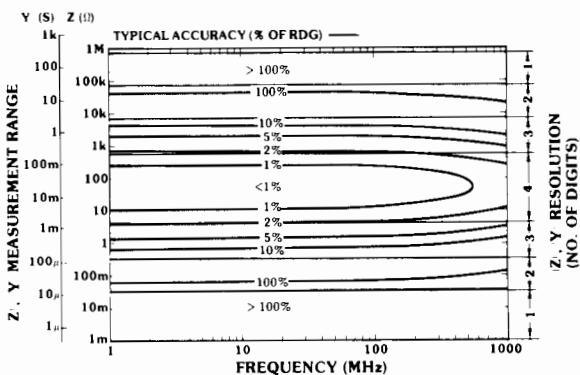
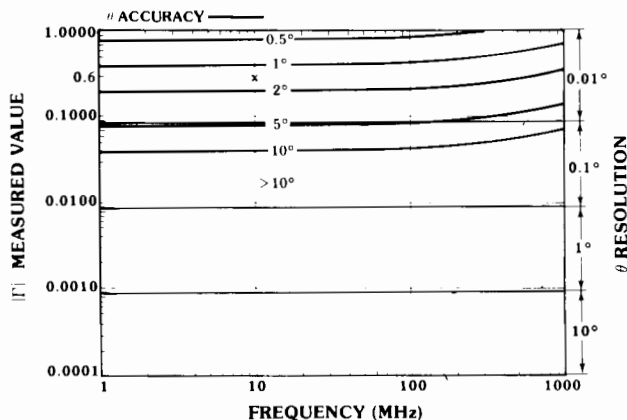
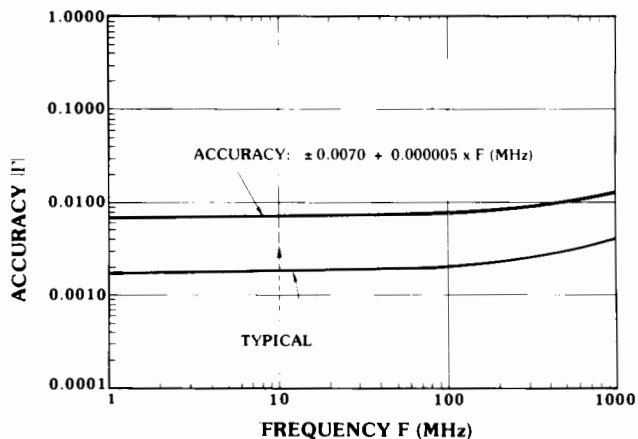

General

Temperature coefficient for $|\Gamma|, \Gamma_x,$ and Γ_y : 0.0001/°C (23 ± 5°C)

Measuring time: 800 ms or 250 ms (high speed mode)

Frequency switching time: ≤ 200 ms

Temperature: 0 - 55°C, < 95% RH

Power: 100, 120, 220 V ± 10%, 240 V + 10% - 5%, 48 - 66 Hz, 150 VA max.

Size: 425.5 mm (W) × 230 (H) × 574 (D) mm (16.75" x 9" x 22.6")

Weight: Approx. 24 Kg. (52.8 lbs.)

Accessories furnished: accessory case (with reference terminations included).

Accessories Available

Accessories Available	Price
16091A Coaxial Fixture Set	\$460
16092A Spring Clip Fixture	\$450
16093A Binding Post Fixture	\$165
16093B Binding Post Fixture	\$170
16094A Probe Fixture	\$145

Options

002: 100 Hz/200 Hz resolution synthesizer	\$1,650
004: Recorder Outputs	\$445

4191A RF Impedance Analyzer

\$14,260

COMPONENT MEASUREMENT

LF Impedance Analyzer (5 Hz to 13 MHz)

Model 4192A

- 5 Hz to 13 MHz Variable Measuring Frequency
- Gain-Phase Measurement: Amplitude, Phase and Delay
- Floating or Grounded Devices
- Impedance Measurement: $|Z| \cdot |Y| \cdot \theta \cdot R \cdot X \cdot G \cdot B \cdot L \cdot C \cdot D \cdot Q \cdot \Delta \cdot \Delta\%$
- Standard HP-IB

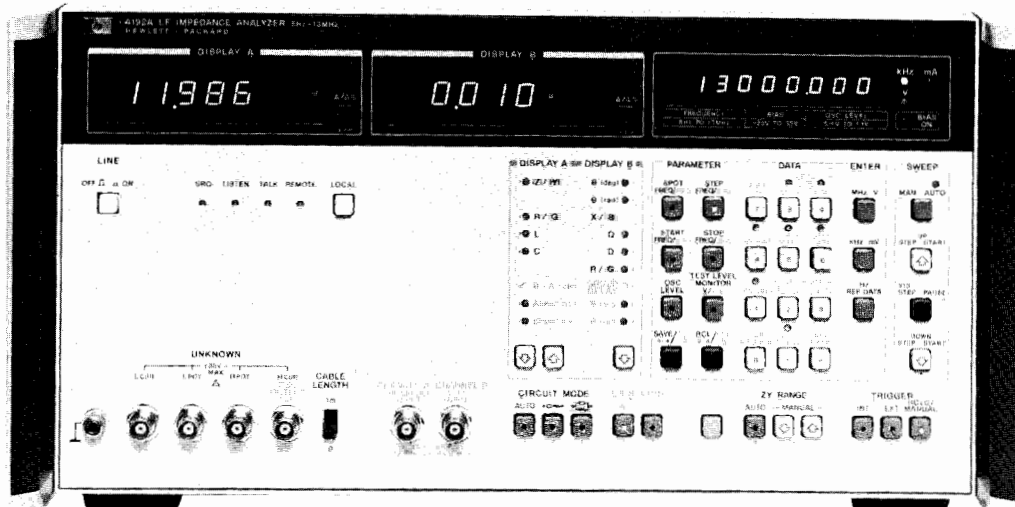

Description

The 4192A LF Impedance Analyzer performs both network analysis and impedance analysis on devices such as telecommunication filters, audio/video electronic circuits, and basic electronic components. Both floating and grounded devices can be tested.

Automatic Swept Frequency Measurement of All Impedance Parameters

The 4192A can measure 11 impedance parameters ($|Z|$, $|Y|$, θ , R, X, G, B, L, C, D, Q) over a wide range $|Z|$: 0.1 m Ω to 1 M Ω ; $|Y|$: 1 nS to 1 S).

The built-in frequency synthesizer can be set from 5 Hz to 13 MHz with a maximum resolution of 1 mHz. This feature allows accurate characterization of high Q devices such as crystals. Test signal level is variable from 5 mV to 1.1 V with 1 mV resolution. Also, an internal dc bias voltage source provides ± 35 V at 10 mV increments. Thus, the 4192A can evaluate components and entire circuits near actual operating conditions.

Specifications (Complete specifications on data sheet)

Measuring signal (23 \pm 5 $^{\circ}$ C)

Frequency range: 5 Hz to 13 MHz

Frequency step: 0.001 Hz (5 Hz to 10 kHz), 0.01 Hz (10 kHz to 100 kHz), 0.1 Hz (100 kHz to 1 MHz), 1 Hz (1 MHz to 13 MHz).

Frequency accuracy: ± 50 ppm

OSC level: 5 mV to 1.1 Vrms variable into 50 Ω (amplitude-phase measurement) or open circuit (impedance measurement).

OSC level step: 1 mV (5 mV to 100 mV), 5 mV (100 mV to 1.1 V)

OCS level accuracy: 5 Hz to 1 MHz: $\pm(5 + 10/f)\%$ of setting ± 2 mV where f is in Hz. 1 MHz to 13 MHz: $\pm(4 + 1.5 \times F)\%$ of setting ± 2 mV where F is in MHz.

Level monitor (impedance measurement): Current through or voltage across sample can be monitored

Control: spot and sweep via front panel or HP-IB

Measuring Mode

Spot measurement: at specific frequency (or dc bias)

Swept measurement: manual or automatic sweep from START to STOP frequency (or dc bias) at selected STEP frequency (or dc bias) rate

Sweep Mode: linear or logarithmic (frequency only)

Recorder outputs: output dc voltage proportional to each measured value, and frequency or dc bias.

Maximum output voltage: ± 1 V

Output voltage accuracy: $\pm 0.5\%$ of voltage ± 20 mV

Key status memory: 5 sets of measuring conditions can be stored and recalled at any time.

HP-IB data output and remote control: standard

Self-test: automatic introspective testing

Trigger: internal, external or manual

Amplitude—Phase Measurement

Parameter measured: relative amplitude B-A (dB) and phase θ (degrees or radians), B-A and group delay, absolute amplitude A (dBm or dBV) or B (dBm or dBV), and deviation (Δ , $\Delta\%$) of all parameters

Reference amplitude: 0 dBV = 1 Vrms, 0 dBm = 1 mW (with 50 Ω termination)

OSC output resistance: 50 Ω

Channels A and B: input impedance: 1 M $\Omega \pm 2\%$, shunt capacitance: 25 pF ± 5 pF

Display range and resolution:

B-A: 0 to ± 100 dB*, 0.001 dB (0 to ± 20 dB), 0.01 dB (± 20 to ± 100 dB)

θ : 0 to $\pm 180^{\circ}$, 0.01 $^{\circ}$

Group delay: 0.1 ns to 19 s, max. resolution 4 1/2 digits

A or B: +0.8 to -100 dBV*, 0.001 dB (> -20 dB), 0.01 dB (< -20 dB), +13.8 to -86 dBm, 0.001 dB (> -7 dBm), 0.01 dB (< -7 dBm)

Measuring accuracy (23 \pm 5 $^{\circ}$ C): Specified at BNC unknown terminals after 30 minute warmup (test speed: normal or average)

B-A (Relative Amplitude) and θ (Phase) Measurement: Determined by sum of channel A and B accuracies given below (accuracy of each channel changes according to absolute input level)

*Accuracy of relative and absolute gain measurements is specified from 0 dB to ± 80 dB.

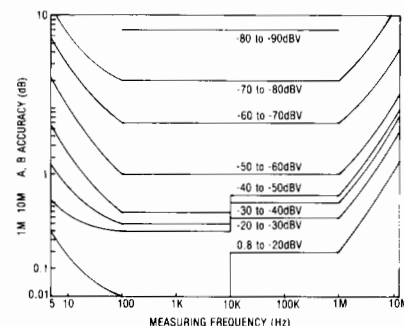

FIGURE 1: GAIN MEASUREMENT ACCURACY

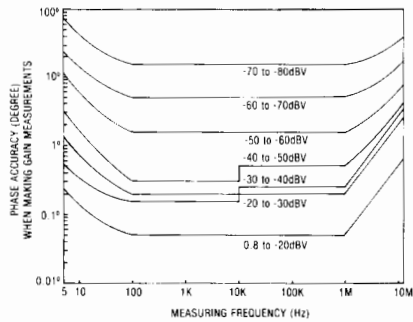

FIGURE 2: PHASE ACCURACY WHEN MAKING GAIN MEASUREMENTS

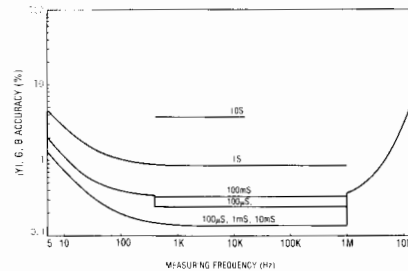

FIGURE 5: G, B ACCURACY

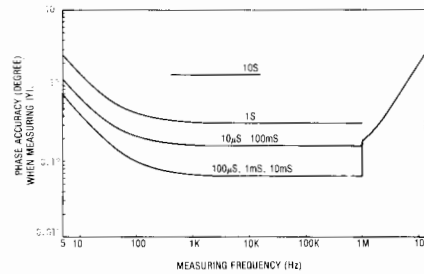



FIGURE 6: PHASE ACCURACY WHEN MEASURING Y

Impedance Measurement

Parameter measured: $|Z| - \theta, |Y| - \theta, R - X, G - B, L - D \cdot Q \cdot R \cdot G, C - D \cdot Q \cdot R \cdot G$ and deviation ($\Delta, \Delta\%$) of all parameters

Display: 4½ digits, max. display 12999 counts

Circuit mode: Series equivalent circuit () and parallel equivalent circuit (). Automatic selection available.

Auto ZERO adjustment: Automatic normalization of the readout offset due to residuals of the test fixture by pushbutton operation (at spot frequency)

Measuring range and accuracy (23 ± 5°C): Specified at BNC unknown terminals after 30 minute warmup when OSC level is more than 0.3 V and when auto ZERO adjust is performed (test speed: normal or average). Accuracy given below is only valid when the measured value is equal to full scale of each range.

|Z| - θ, R - X Measurement: Range: |Z|, R, X: 0.1 mΩ to 1.2999 MΩ; θ: -180.00° to +180.00°. Accuracy: R accuracy (D ≥ 10); X accuracy (D ≤ 0.1)

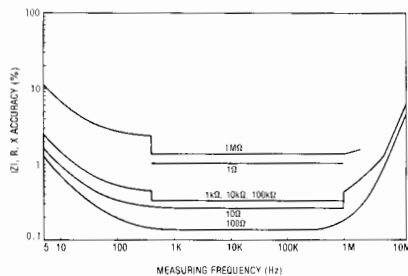

FIGURE 3: Z, R, X ACCURACY

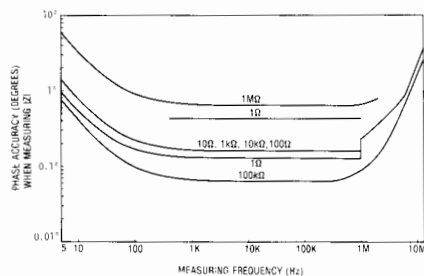

FIGURE 4: PHASE ACCURACY WHEN MEASURING Z

|Y| - θ, G - B Measurement: Range: |Y|, G, B: 1 nS to 12.999 S; θ: -180.00° to +180.00°. Accuracy: G accuracy (D ≥ 10); B accuracy (D ≤ 0.1).

L - D · Q, C - D · Q Measurement: (automatically calculated from measured Z/Y values)

Parameter	Measuring Range*	Basic Accuracy
L	0.01 nH to 1000 H	0.27%
C	0.1fF to 199° mF	0.15%
D(1/Q)	0.0001 to 19.999	0.001 (C-measurement) 0.003 (L-measurement)

*Varies with measuring frequency except for D(1/Q)

**Accuracy of C ranges over 100 mF is not specified.

Internal DC Bias: Standard (Impedance Measurement only)

Voltage range: -35 V to +35 V, 10 mV step

Setting accuracy (23 ± 5°C): 0.5% of setting + 5 mV

Bias control: spot and swept, front panel HP-1B

General

Measuring time (high speed mode):

B-A and θ, A or B: 113 to 127 ms (≥ 400 Hz)

Impedance parameters: 58 to 91 ms (≥ 1 kHz)

Test level monitor range (impedance measurement):

Voltage: 5 mV to 1.1 V

Current: 1 μA to 11 mA

Operating Temperature: 0 to 55°C, ≤ 95% RH at 40°C

Power: 100, 120, 220 V ± 10%, 240 V + 5% to -10%, 48 to 66 Hz

Size: 425.5mm (W) x 230mm (H) x 574mm (D) (16.75" x 9" x 22.6")

Weight: Approx. 19 kg (41.9 lbs.)

Furnished accessories and parts: 16047A test fixture, 50Ω feed thru terminations (2 ea.), power splitter, BNC cables (2 ea.), BNC adapter

Accessories available:

Accessories available:	Price
16095A Probe Fixture	\$450
16096A 2-port Component Test Fixture	\$850
16097A Accessory Kit	\$1,550
16047C 2-terminal Test Fixture	\$280
16048B Test Leads (miniature connector)	\$275
16048C Test Leads with alligator clip	\$350

4274A/4275A's test fixtures/leads are usable with 4192A

4192A LF Impedance Analyzer

\$11,550

COMPONENT MEASUREMENT

Vector Impedance Meter (400 kHz to 110 MHz)

Model 4193A

- 400 kHz to 110 MHz Spot or Swept Frequency
- Measure Impedance Magnitude (10 mΩ to 120.0 kΩ) and Phase (−180.0° to +180.0°)
- Test Components In-Circuit and Out-of-Circuit
- Fixtures Include Low-grounded Probe, Spring Clip Fixture and Binding Post Fixture
- Standard HP-IB and Analog Outputs

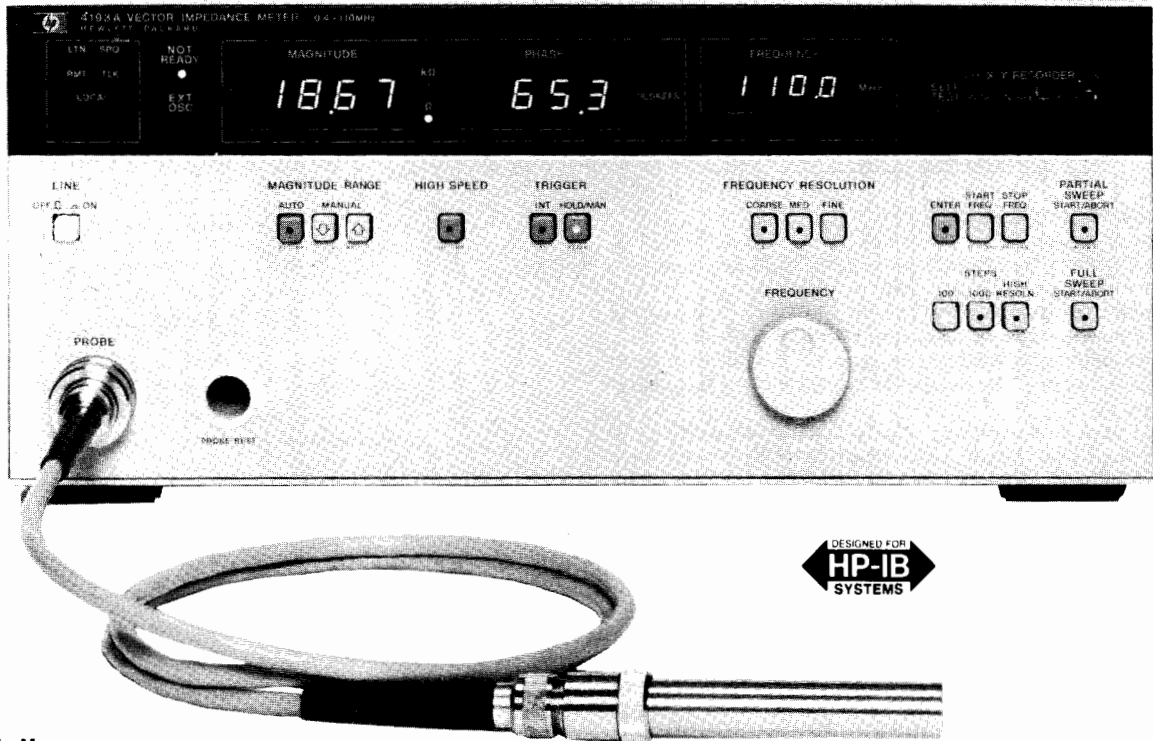

Description

The HP Model 4193A Vector Impedance Meter measures impedance magnitude and phase. An internal oscillator provides test signals from 400 kHz to 110.0 MHz. The test signal is constant current between 10 μA and 100 μA, depending on |Z| range.

Reliable and Accurate Impedance Measurement

The 4193A can measure and display impedance magnitudes from 10 mΩ to 120.0 kΩ. Impedance phase is displayed from +180.0° to −180.0°. Accuracy is as good as 3.0% of reading (magnitude) and 3.2° (phase).

Also, the 4193A's 3½ digit resolution makes it easy to see small changes in measurement results during adjustment procedures, for example.

Frequency Sweep for Complex Component Testing

When testing complex components like ceramic resonators, it is useful (1) to sweep frequency to get the big picture and (2) identify critical impedance points like series resonant point. This requires both swept measurement and measurements at individual "spot" frequencies. The 4193A can do both.

The 4193A can be tuned to any individual frequency from 400 kHz to 110.0 MHz with maximum resolution of 1 kHz. If greater frequency resolution is required, it can be provided by connecting an external synthesized source like the HP 3335A or 8656A to the 4193A EXT OSC input.

Flexible internal frequency sweep is an exciting 4193A feature. Frequency can be swept linearly over any portion of the 4193A frequency range—or swept logarithmically over the entire 400 kHz to 110.0 MHz range.

Test In-Circuit and Out-of-Circuit Components

Several test fixtures help adapt the 4193A to your device under test. For example, the handy L-ground probe is useful for in-circuit test-

ing. The 16099A Test Fixture Adapter and three associated fixtures help connect to out-of-circuit devices of various sizes and shapes.

Easy to Use—Both Manually and Under HP-IB Control

The 4193A front panel is amazingly simple. In just a few minutes you can become an expert operator. This is a big time saver over most other impedance meters which are usually much more difficult to operate. Plus, the 4193A has standard HP-IB, making it a good choice for automated testing in R & D, incoming inspection, production and product assurance.

Specifications

Test Signal Output Specifications:

test signal is output from the furnished low-ground probe.

Frequency range: 400 kHz to 110.0 MHz

Frequency resolution:

400 kHz to 9.999 MHz: 1 kHz resolution

10.00 MHz to 99.99 MHz: 10 kHz resolution

100.0 MHz to 110.0 MHz: 100 kHz resolution

Frequency accuracy: ±0.01% of setting after calibration.

Frequency stability: ±100 ppm per month (0 to 55°C)

Frequency control:

Spot: spot frequency is set using coarse, medium and fine controls

Full sweep: logarithmic sweep at 43 points over full range of 400 kHz to 110 MHz

Partial sweep: linear sweep from selected START to STOP frequency. Number of steps is selected as 100, 1000 or "HIGH RESOLN". When "HIGH RESOLN" steps is selected, the operator must also select "coarse", "medium" or "fine" resolution.

EXT OSC: Increase frequency resolution by connecting an external frequency synthesizer like the HP 3335A or 8656A.

Input signal level: 0 dBm to +5 dBm
Input impedance: 50 ohms ± 10%
Frequency range: 400 kHz to 110 MHz
Test level: constant current source

Z Range	Current in $\mu A \pm 20\%$	Voltage ¹ Across DUT in μV_{rms}
10 Ω	100	1
100 Ω	100	10
1 k Ω	100	100
10 k Ω	50	500
100 k Ω	10	1000

¹Voltage across DUT depends on |Z| of DUT. The voltage shown is across a |Z| of range value. For example, 1 V_{rms} would appear across |Z| of 10 Ω on the 100 Ω range.

Impedance Measurement Specifications:

Input Configuration: low-grounded probe (furnished)
Residual impedance of probe (at probe tip)
Resistance: <0.55 Ω
Inductance: <(4.9 + 10/f) nH where f is measuring frequency in MHz
Capacitance: <0.11 pF
Digital display of impedance: 3½ digits
|Z|: 0 to 1999 counts (0 to 1200 counts on 100 k Ω range)
 θ : -1800 to +1800 counts
Measurement trigger: internal, external, and manual
Measurement range control: auto, hold, and manual
Measurement range:
|Z|: Five decade ranges: 10 Ω , 100 Ω , 1k Ω , 10 k Ω , 100 k Ω
minimum |Z| (sensitivity): 10 m Ω
maximum |Z|: 120.0 k Ω
 θ : One range: -180.0° to +180.0°

Recorder output: dc voltage proportional to measured |Z|, θ and measurement frequency.

Output voltage: accuracy specification for all recorder output voltages is ±(1% + 20 mVdc)
|Z|: 0 Vdc (0000 display counts) to +1 Vdc (1999 display counts)
 θ : -1 Vdc (-180.0°) to +1 Vdc (+180.0°)
Frequency:
Full sweep: 0 Vdc (400 kHz) to +1 Vdc (110 MHz), log sweep
Partial sweep: 0 Vdc (START frequency) to +1 Vdc (STOP frequency), linear sweep
HP-IB remote control and data output: standard
Self-test: standard

General Information

Test Signal Output
Frequency settling time: 5 ms to 300 ms. Best case is when ($\frac{\Delta f}{f}$)% is less than 10% (below 10 MHz) and less than 1% (above 10 MHz).
Signal purity:
Spurious: -60 dBc (dBc is dB below carrier)
Harmonics: -30 dBc
Residual FM: measured in a 100 Hz band centered on the carrier
400 kHz to 1 MHz: 40 Hz p-pFM
1 MHz to 110 MHz: 100 Hz p-pFM
Impedance Measurement
Measuring speed: assumes range is fixed; recorder output is OFF
HI SPEED: approximately 150 msec per measurement
NORMAL: approximately 1 sec per measurement
Ranging time: approximately 400 msec per range plus one measuring interval (e.g., 1 sec in normal mode)
Temperature coefficient at 23°C ± 5°C
|Z|: 2 m Ω /°C
 θ : 0.02°/°C

|Z| and θ Measurement Accuracy: in the Table below, "f" is in MHz

Range	Accuracy	Measuring Frequency in Megahertz		
		4	1	10
10 Ω Range	Z Accuracy	$\pm[(5.7 + 0.56/f)\% \text{ rdg} + 9 \text{ counts}]$	$\pm(6.3\% \text{ rdg} + 6 \text{ counts})$	$\pm[(4.5 + 0.18f)\% \text{ rdg} + 4 \text{ counts}]$
	θ Accuracy	$\pm(1.7 + 1.8/f + \frac{35}{ Z \text{counts}}) \text{ deg}$	$\pm(3.3 + 0.20f + \frac{35}{ Z \text{counts}}) \text{ deg}$	$\pm[(2.6 + 0.037f)\% \text{ rdg} + 4 \text{ counts}]$
100 Ω Range	Z Accuracy	$\pm[(2.4 + 0.56/f)\% \text{ rdg} + 4 \text{ counts}]$	$\pm(3.0\% \text{ rdg} + 4 \text{ counts})$	$\pm[(2.6 + 0.037f)\% \text{ rdg} + 4 \text{ counts}]$
	θ Accuracy	$\pm(1.5 + 1.9/f + \frac{35}{ Z \text{counts}}) \text{ deg}$	$\pm(3.3 + 0.035f + \frac{35}{ Z \text{counts}}) \text{ deg}$	
1 k Ω Range	Z Accuracy	$\pm[(3.2 + 0.56/f)\% \text{ rdg} + 4 \text{ counts}]$	$\pm(3.7\% \text{ rdg} + 4 \text{ counts})$	$\pm[(2.7 + 0.11f)\% \text{ rdg} + 4 \text{ counts}]$
	θ Accuracy	$\pm(1.6 + 1.8/f + \frac{35}{ Z \text{counts}}) \text{ deg}$	$\pm(3.3 + 0.11f + \frac{35}{ Z \text{counts}}) \text{ deg}$	
10 k Ω Range	Z Accuracy	$\pm[(2.9 + 56/f)\% \text{ rdg} + 4 \text{ counts}]$	$\pm[(3.2\% + 0.29f)\% \text{ rdg} + 4 \text{ counts}]$	$\pm[(.74 + .53f)\% \text{ rdg} + 4 \text{ counts}]$
	θ Accuracy	$\pm(2.1 + 1.9/f + \frac{35}{ Z \text{counts}}) \text{ deg}$	$\pm(3.1 + 0.53f + \frac{35}{ Z \text{counts}}) \text{ deg}$	$\pm(8.3 + .01f + \frac{35}{ Z \text{counts}}) \text{ deg}$
100 k Ω Range	Z Accuracy	$\pm[(3.3 + 0.56/f)\% \text{ rdg} + 4 \text{ counts}]$	Not specified	
	θ Accuracy	$\pm(3.0 + 1.9/f + \frac{35}{ Z \text{counts}}) \text{ deg}$	Not specified	

- Guideline for use of the |Z| and θ Accuracy Table**
1. "f" is in MHz.
 2. "rdg" is display reading, for example, 50.0 ohms.
 3. "counts" is display counts in the |Z| display.
 4. "deg" is degrees of arc.

Example: Calculate the |Z| and θ accuracy for a device which gives 4193A readings of |Z| = 50.0 Ω and θ = -45.0°. Assume an 0.9 MHz test frequency 100 Ω range, and normal measuring node.

$|Z| = 50.0 \Omega \pm [(2.4 + \frac{56}{f})\% \text{ of rdg} + 4 \text{ counts}]$
 $|Z| = 50.0 \Omega \pm [(2.4 + \frac{56}{.9}) * \frac{50.00}{100\%} + .4 \Omega]$
 $|Z| = 50.0 \Omega \pm 1.91 \Omega$
 $\theta = -45.0^\circ \pm (1.5 + \frac{1.9}{f} + \frac{35}{|Z|\text{counts}}) \text{ deg}$
 $\theta = -45.0^\circ \pm (1.5 + \frac{1.9}{.9} + \frac{35}{500}) \text{ deg}$
 $\theta = -45.0^\circ \pm 3.68^\circ$

Operating temperature/humidity: 0 to 55°C, 95% RH @ 40°C.
 Note that measurement error in 0°C to 55°C temperature range is typically double the error in the 23°C ± 5°C range.
Power: 100/120/220 V ± 10%, 240 V -10% to +5%, 48 to 66 Hz, Max 150 VA
Size: 426 mm (W) × 178 mm (H) × 498 mm (D), (16.75" × 7" × 19.6")
Weight: 18 kg (40 lbs.)
Accessories furnished: low-ground probe kit includes probe, spare pins, spare clips, BNC adapter, component mounting adapter, probe socket and accessory case.

Accessories Available	Price
16099A Test Fixture Adapter: (used with 16092A, and 16093A/B)	\$280
16092A Spring Clip Fixture: (used with 16099A)	\$450
16093A Binding Post Fixture: (used with 16099A)	\$165
16093B Binding Post Fixture: (used with 16099A)	\$170
4193A Vector Impedance Meter	\$7,350

COMPONENT MEASUREMENT

Digital LCR Meter

Model 4261A

- Fully automatic—autoranging
- Wide range C = 0.1 pF to 19 mF, L = 0.1 μH to 1900 H, R = 1 mΩ to 19 MΩ
- Low cost with high performance
- Versatile accessories/options
- High reliability



Description

The Model 4261A Digital LCR Meter is a new, fully automatic instrument that satisfies many of today's user requirements in the LCR measurement field.

The 4261A features high speed, accurate measurements. The devices under test need only be connected and the function L, C, or R selected. The instrument automatically displays the desired parameter. Tedious balancing operations typically used in conventional manual bridges are completely eliminated. Measurement circuit mode (series or parallel) is also automatically selected.

Complementing its wide LCR measurement range, HP's 4261A has other features such as high accuracy (basically 0.2% of reading), high speed measurement (typically 4 per second), 120 Hz or 1 kHz measurement frequencies, 1 V or 50 mV test signal levels, internal bias sources and parallel or series equivalent circuit modes.

Measurements are taken using the five-terminal method, which easily converts to four, three or two terminals to meet most LCR measurement applications. For example, the four-terminal input could be

used to measure the capacitance of an electrolytic capacitor, the inductance of transformer or the internal resistance of a dry cell. The three-terminal input is appropriate for semiconductor junction capacitance or cable capacitance measurements. To fit these needs, three kinds of optional test leads and fixtures are available. The 4261A can easily measure parameters of pulse transformers, filter coils and electrolytes in addition to ordinary LCR components.

Expanded use features of this highly reliable instrument include optionally available digital output and remote control which enable a wide range of applications from the research laboratory to the production line.

Specifications

Parameter measured: C-D (Capacitance & Dissipation Factor), L-D (Inductance & Dissipation Factor), and R (Resistance).

Display: 3½ digits, max. display 1900.

Circuit mode: Auto, Parallel and Series.

Measuring circuit: 5-terminal method.

Range mode: Auto or Range Hold.

Measurement frequencies: 120 Hz ± 3% and 1 kHz ± 3%.

Trigger: Internal, Manual or External.

Measurement ranges, measurement accuracies & test signal levels: see tables on next page for C-D, L-D, and R measurements.

Accuracy applies over a temperature range of 23°C ± 5°C (at 0°C to 55°C, error doubles).

DC Bias

Internal source: 1.5 V, 2.2 V, 6 V (selectable on front panel).

Accuracy: ± 5%.

External source: provision for external DC bias voltage of +30 V maximum at binding posts on rear panel.

General

Measuring time: typical for approx. 1000 counts on fixed range for low loss measurements. Specific data follows:

1 kHz: C/L 220-260 ms, R 120-160 ms.

120 Hz: C/L 900 ms, R 700 ms.

When auto range is selected, a range selection time of 180 ms at 1 kHz and a range step time 670 ms at 120 Hz is added to the above typical times.

Reading rate: internal trigger—approx. 30 ms between end of measurement and start of next cycle; External trigger—measurement cycle is initiated by remote trigger input.

Data format: + 1-2-4-8 BCD, TTL logic level, "1" (high level).

Operating temperature: 0°C to 55°C.

Humidity: to 95% RH at 40°C.

Voltage requirements: 100/120/220/240 V ± 10%, 48 to 66 Hz.

Power consumption: ≤ 25 VA with any option.

Altitude: 15,240 m (50,000 ft.).

Size: 132.6 H x 213 W x 422 mm D (5¼" x 8¾" x 16¾").

Weight: approx. 7.5 kg (16.5 lb).

R Measurement

RANGE	120 Hz or 1 kHz	1000 mΩ	10,000	100.0Ω	1000Ω	10.00 kΩ	100.0 kΩ	1000 kΩ	10.00 MΩ
Test Signal		1 V							
		70 mA	10 mA	1 mA	100 μA	10 μA			
Level Note 1	AUTO	Same as Mode				Same as Mode			
		0.2% + 2 counts				0.3% + 2 counts			
R Accuracy Note 2		Same as Mode				Same as Mode			
	AUTO	Same as Mode				Same as Mode			

1. Typical data, varies with number of counts.

2. ± (% of reading + counts).



C-D Measurement

RANGE	C	120 Hz 1 kHz	1000 pF 100.0 pF	10.00 nF 1000 pF	100.0 nF 10.00 nF	1000 nF 100.0 nF	10.00 μF 1000 nF	100.0 μF 10.00 μF	1000 μF 100.0 μF	10.00 mF 1000 μF			
	D	0.001 to 1.900, common to all C ranges.											
Test Signal Level Note 1		1 V or 50 mV											
		10 μA					100 μA		1 mA		10 mA		70 mA
	AUTO	Same as Mode					Same as Mode						
C Accuracy Note 2 Note 2		0.2% + 1 count + 0.2 pF					(Test signal level; 1 V)						
		0.5% + 3 counts		0.3% + 2 counts								(Test signal level; 50 mV)	
	AUTO	Same as Mode					0.3% + 2 counts		0.5% + 2 counts		1% + 2 counts [‡]		
D Accuracy Note 2		0.2% + (2 + 200/Cx) counts					(Test signal level; 1 V)						
		0.3% + (2 + 1000/CX) counts					(Test signal level; 50 mV)						
	AUTO	Same as Mode					0.3% + (2 + Cx/500) counts				1% + (5 + Cx/500) counts		

- 1. Typical data, varies with value of D and number of counts.
- 2. ± (% of reading + counts + α). Cx is capacitance readout in counts.
- ‡ (5% + 2 counts) at 1 kHz.

L-D Measurement

RANGE	L	120 Hz 1 kHz	1000 μH 100.0 μH	10.00 mH 1000 μH	100.0 mH 10.00 mH	1000 mH 100.0 mH	10.00 H 1000 mH	100.0 H 10.00 H	1000 H 100.0 H	
	D	0.001 to 1.900, common to all L ranges.								
Test Signal Level Note 1		1 V								
		70 mA		10 mA		1 mA		100 μA		10 μA
	AUTO	Same as Mode					Same as Mode			
L Accuracy Note 2		0.3% + 2 counts					1% + 2 counts			
		0.2% + 2 counts + 0.2 μH								
	AUTO	Same as Mode					Same as Mode			
D Accuracy Note 2		0.3% + (3 + Lx/500) counts					1 1% + (3 + Lx/500) counts			
		0.2% + (3 + 200/Lx) counts								
	AUTO	Same as Mode					Same as Mode			

- 1. Typical data, varies with value of D and number of counts.
- 2. ± (% of reading + counts + α). Lx is inductance readout in counts.

Accessories Available

- 16061A:** Test Fixture (direct coupled type), 5-terminal
- 16062A:** Test Leads with alligator clips, 4-terminal (for low impedance measurements)
- 16063A:** Test Leads with alligator clips, 3-terminal (for high impedance measurements)

Options Available

- Opt 001:** BCD Output of C/L/R and D (simultaneous)
- Opt 002:** BCD Output of C/D, L/D and R (alternately)

Opt 003: BCD Remote Control (except for DC bias function)

Ordering Information

16061A Test Fixture	\$160
16062A Test Leads	\$85
16063A Test Leads	\$85
Opt 001: BCD Output (Simultaneous)	add \$185
Opt 002: BCD Output (Alternately)	add \$160
Opt 003: BCD Remote Control	add \$80
Opt 910: Extra Manual	add \$23

4261A Digital LCR Meter

\$2410

COMPONENT MEASUREMENT

Digital LCR Meter

Model 4262A

- Automatic balancing, ranging & circuit mode selection
- Test frequencies of 120 (100) Hz, 1 kHz and 10 kHz

- HP-IB, BCD and Comparator options available
- Microprocessor control features self test and deviation measurement capabilities

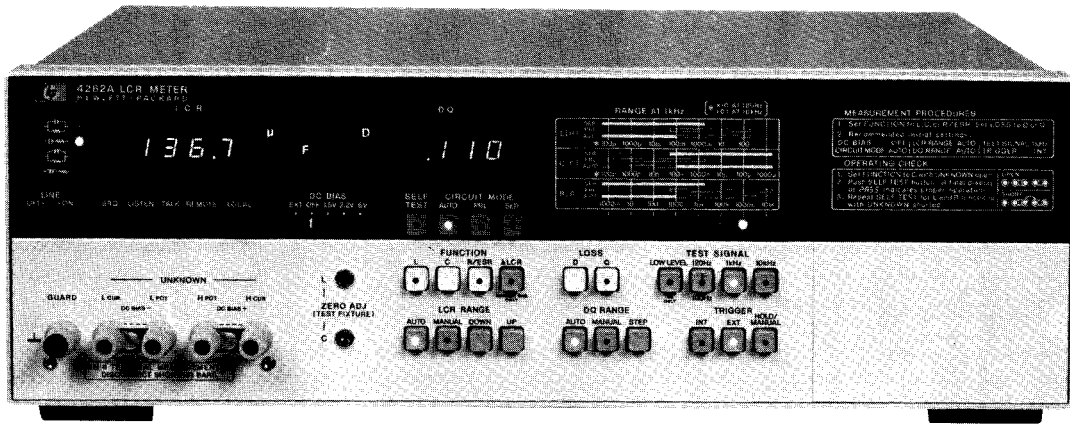

The HP 4262A is a 3½ digit microprocessor based Digital LCR Meter that meets today's requirements for component measurements in the lab, on the production line, and in the QA inspection area. The 4262A features fully automatic operation over a wide range of measurements. Simply select the function and loss parameters, one of three test frequencies, and insert the device to be measured. The instrument does the rest—automatically selecting the proper measurement range and equivalent circuit mode.

In addition to automatic measurements and wide range, the 4262A features high accuracy (as good as 0.2% of reading), 120 (100) Hz, 1 kHz, and 10 kHz measurement frequencies, 1 V test signal level (1 V or 50 mV in Cp mode), three internal DC bias levels (plus external) and series and parallel equivalent circuit modes. The microprocessor control allows other features such as an automatic self test capability and deviation measurements. These features make the 4262A capable of meeting the measurement needs of the diversified electronics

industry by measuring such things as the parameters of semiconductors, pulse transformers, filter coils, electrolytic and film capacitors, or determining the internal resistance of a dry cell.

The arrangement of the front panel keyboard switches insure maximum operating convenience and error-free operation. When the instrument is turned on, the microprocessor automatically selects capacitance, dissipation factor, 1 kHz test signal, autorange, auto circuit mode selection, internal trigger and normal test voltage mode of operation. Individually LED lighted keys allow the user to easily determine the selected functions at a glance.

Several options are available for the user that needs systems capability. A BCD output of LCR and DQ data is available for use with a printer or calculator. If both data output and remote control are required, HP-IB compatibility is available. A comparator option (for both LCR and DQ data) is also available.

Specifications

Accuracy: All accuracies apply over a temperature range of 23°C ± 5°C (at 0°C to 55°C, error doubles)

C-D and C-Q Measurement

Range	C	120 (100) Hz 1 kHz 10 kHz	1000 pF 100.0 pF 10.00 pF	10.00 nF 1000 pF 100.0 pF	100.0 nF 10.00 nF 1000 pF	1000 nF 100.0 nF 10.00 nF	10.00 μF 1000 nF 100.0 nF	100.0 μF 10.00 μF 1000 nF	1000 μF 100.0 μF 10.00 μF	10.00 mF 1000 μF 100.0 μF	
	D	.001-19.9 (2 Ranges)									
Q	*1 .050-1000 (4 Ranges)										
Test Signal Level *2	1 V or 50 mV										
	AUTO	Same as Mode					Same as Mode				
C Accuracy *3		0.2% + 1 count					(Test signal level: 1 V)				
		0.5% + 3 Counts	0.3% + 2 counts					(Test signal level: 50 mV)			
		At 120 (100) Hz, 1 kHz					0.3% + 2 counts				
		At 10 kHz					0.5% + 2 counts 1% + 2 counts 5% + 2 counts				
AUTO	Same as Mode					Same as Mode					
D (1/Q) Accuracy *3		0.2% + (2 + 200/Cx) counts					At 120 (100) Hz, 1 kHz (Test signal level: 1 V)				
		0.5% + (2 + 200/Cx) counts					At 10 kHz				
		0.3% + (2 + 1000/Cx) counts					At 120 (100) Hz, 1 kHz (Test signal level: 50 mV)				
		1.0% + (2 + 1000/Cx) counts					At 10 kHz				
At 120 (100) Hz, 1 kHz					0.3% + (2 + Cx/500) counts					1% + (5 + Cx/500) counts	
At 10 kHz					0.5% + (2 + Cx/500) counts					1% + (5 + Cx/500) counts	5% + (5 + Cx/500) counts
AUTO	Same as Mode					Same as Mode					

*1. Calculated from D value as a reciprocal number.
*2. Typical data, varies with value of D and number of counts.

*3. ± (% of reading + counts) Cx is capacitance readout in counts. Accuracies in this table apply when D < 1.999.

*4. 5% + 2 counts at 1 kHz.

L-D and L-Q Measurement

Range	C	120 (100) Hz 1 kHz 10 kHz	1000 μ H 100.0 μ H 10.00 μ H	10.00 mH 1000 μ H 100.0 μ H	100.0 mH 10.00 mH 1000 μ H	1000 mH 100.0 mH 10.00 mH	10.00 H 1000 mH 100.0 mH	100.0 H 10.00 H 1000 mH	1000 H 100.0 H 10.00 H		
		D	.001-19.9 (2 Ranges)								
	Q	.050-1000 (4 Ranges)									
Test Signal Level *2		1 V									
	AUTO	40 mA				10 mA		1 mA		100 μ A	
L Accuracy *3		At 120 (100) Hz, 1 kHz				0.3% + 2 counts		1% + 2 counts			
		At 10 kHz				0.3% + 2 counts		1% + 2 counts		5% + 2 counts	
		0.2% + 2 counts				0.2% + 2 counts		At 120 (100) Hz, 1 kHz			
	AUTO	Same as Mode				Same as Mode		Same as Mode			
D (1/Q) Accuracy *3		At 120 (100) Hz, 1 kHz				0.3% + (3 + Lx/500) counts		1% + (3 + Lx/500) counts			
		At 10 kHz				0.5% + (3 + Lx/500) counts		1% + (3 + Lx/500) counts		5% + (5 + Lx/500) counts	
		0.2% + (3 + 200/Lx) counts				0.5% + (3 + 200/Lx) counts		At 120 (100) Hz, 1 kHz			
	AUTO	Same as Mode				Same as Mode		Same as Mode			

*1 Calculated from D value as a reciprocal number

*3 \pm (% of reading + counts) Lx is inductance readout in counts. Accuracies in this table apply when D < 1.999.

*2 Typical data varies with value of D and number of counts

R/ESR** Measurement

Range	120 (100) Hz 1 kHz 10 kHz	1000 m Ω	10.00 Ω	100.0 Ω	1000 Ω	10.00 k Ω	100.0 k Ω	1000 k Ω	10.00 M Ω		
Test Signal Level *1		1 V									
	AUTO	40 mA				10 mA		1 mA		100 μ A	
Accuracy *2		Same as Mode				Same as Mode		0.3% + 2 counts *3			
	AUTO	Same as Mode				Same as Mode		Same as Mode			

*1 Typical data, varies with number of counts

*2 \pm (% of reading + counts)

*3 \pm (5% + 2 counts) on 10.00 M Ω range at 10 kHz test frequency.

** The measurement range for ESR is from 1 m Ω to 19 k Ω (typical). These values vary depending on the series capacitance or inductance value of the device under test.

Parameters measured: C-D or C-Q (1/D), L-D or L-Q (1/D), R (ESR).

Display: dual 3 $\frac{1}{2}$ digit, maximum display of 1999. For D value greater than 10, maximum D display is 199.

Measurement terminals: 5-terminal configuration.

Measurement circuit modes: auto, parallel and series.

Test frequencies: 120 (100) Hz, 1 kHz and 10 kHz \pm 3%.

Range mode: LCR—Auto and manual (up-down), D/Q Auto and manual (step).

Trigger: internal, external or manual.

Deviation measurement: when the Δ LCR switch is depressed, the measurement value is stored in memory as a reference value. At the same time, the range is set to "Manual" and the display is offset to zero. Deviation is displayed as the difference between a stored value and subsequent measurement data. Deviation is in counts from -999 to 1999.

Offset adjustments: front panel adjustments to compensate for stray capacitance and residual inductance of the test fixtures.

C: 0 to 10 pF. **L:** 0 to 1 μ H.

Self test indicators: when the SELF TEST function is selected, the results of the test are displayed in the LCR and DQ window. Results are indicated by PASS, FAIL 1, FAIL 2 or FAIL 3.

DC bias: internal: 1.5 V, 2.2 V and 6 V (selectable on front panel). Accuracy \pm 5%; external: Provision for external DC bias (0 to +40V).

General

Measurement time (typical) for a 1000 count measurement on a low loss component on a fixed range:

1 kHz, 10 kHz: C/L 220-260 ms, R 120-160 ms

120 (100) Hz: C/L 900 ms, R 700 ms

When autorange is selected, the following times per range step must be added to the above time:

1 kHz, 10 kHz: 45 ms/180 ms per range step

120 (100) Hz: 150 ms/670 ms per range step

When the uncal lamp is lit, the faster ranging time is selected.

Reading rate: INT (Internal Trigger) approximately 30 ms between the end of a measurement cycle and the start of the next cycle. EXT (External Trigger) measurement cycle is initiated by a remote trigger input.

Operating temperature and humidity: 0°C to 55°C; to 40°C at 95% RH.

Power requirements: 100/120/220 VAC \pm 10%, 240 Vac +5% - 10%; 48-66 Hz.

Power consumption: \leq 55 VA with any option.

Size: 147 mm H x 426 mm W x 345 mm D (5 $\frac{3}{4}$ " x 16 $\frac{3}{4}$ " x 13 $\frac{3}{4}$ ").

Weight: Approximately 8 kg (17.5 lbs).

Accessories available: 16061A: test fixture, direct coupled, 5-terminal; 16062A: test leads with alligator clips, 4-terminal (for low impedance measurements); 16063A: test leads with alligator clips, 3-terminal (for high impedance measurements).

Options available: Opt 001: BCD data output of LCR and DQ data. Opt 004: Digital comparator for LCR and DQ data. Comparison output (HIGH, IN, LOW); visual, relay contact closure and TTL level. Not compatible with Opt 101. Opt 101: HP-IB Data Output and Remote Control. Not compatible with Opt 001 and 004.

Options and Accessories

001: BCD Output

Price

004: Digital Comparator

\$340

010: 100 Hz Test Frequency

\$810

101: HP-IB Interface

N/C

908: Rack Flange Kit

\$545

910: Extra Manual

\$25

16061A Test Fixture

\$29

16062A Test Cables

\$160

16063A Test Cables

\$85

\$85

4262A Digital LCR Meter

\$3225

COMPONENT MEASUREMENT

1 MHz Digital LCR Meter

Model 4271B

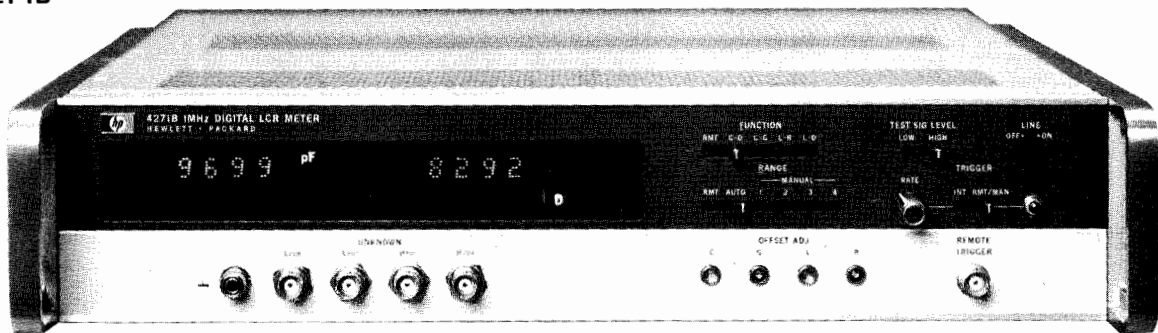

Description

The HP 4271B 1 MHz LCR Meter meets the requirements of the lab, manufacturing and where automatic high speed and accuracy measurements are essential. The four-pair measurement technique

has the advantage of reducing errors due to residual inductance, stray capacitance, and electromagnetic coupling of leads. Offset adjustments are provided to cancel the residuals of the test fixtures.

Typical applications include microcircuit measurements, C-V characteristics of semiconductor devices and passive component tests.

Specifications

Full scale ranges and accuracy: (When conductance reading is less than 100 counts and resistance reading is less than 1000 counts.) Accuracy listed in the following table applies over a temperature range of 23°C ± 5°C.

Capacitance and conductance/dissipation factor: using parallel equivalent circuit.

Range	Test Sig Level	Capacitance: (Overrange 90%)		Conductance: (Overrange 90%)		Dissipation Factor*: (Overrange 60%)	
		Full Scale Display	Accuracy**	Full Scale Display	Accuracy**	Full Scale Display	Accuracy**
1	HIGH	10.000 pF	0.1 + 7	100.00 μS	0.2 + (7 + N _c /1000)	1.0000	1.0 + (10 + 20000/N _c)
	LOW		0.2 + 8		0.3 + (7 + 2 N _c /1000)		1.0 + (15 + 30000/N _c)
2	HIGH	100.00 pF	0.1 + 3	1000.0 μS	0.2 + (3 + N _c /1000)	1.0000	1.0 + (10 + 10000/N _c)
	LOW		0.2 + 4		0.3 + (3 + 2 N _c /1000)		1.0 + (15 + 20000/N _c)
3	HIGH	1000.0 pF	0.1 + 2	10.000 mS	1.2 + (2 + 2 N _c /1000)	1.0000	10 + (10 + 10000/N _c)
	LOW		0.2 + 3		1.2 + (2 + 2 N _c /1000)		1.0 + (15 + 20000/N _c)
4***	LOW	10.000 nF	0.4 + 3	100.00 mS	1.2 + (2 + 2 N _c /1000)	1.0000	1.0 + (15 + 30000/N _c)

Inductance and resistance/dissipation factor: using series equivalent circuit.

Range	Test Sig Level	Inductance: (Overrange 90%)		Resistance: (Overrange 90%)		Dissipation Factor*: (Overrange 90%)	
		Full Scale Display	Accuracy**	Full Scale Display	Accuracy**	Full Scale Display	Accuracy**
1***	LOW	1000.0 nH	1.0 + 15	10.000 Ω	1.2 + (8 + 2 N _L /1000)	1.0000	1.0 + (20 + 30000/N _L)
2	HIGH	10.000 μH	0.6 + 4	100.00 Ω	1.2 + (2 + 2 N _L /1000)	1.0000	1.0 + (15 + 10000/N _L)
	LOW		0.6 + 6		1.2 + (2 + 2 N _L /1000)		1.0 + (20 + 20000/N _L)
3	HIGH	100.00 μH	0.2 + 4	1000.0 Ω	0.3 + (2 + 2 N _L /1000)	1.0000	1.0 + (15 + 10000/N _L)
	LOW		0.3 + 6		0.5 + (2 + 2 N _L /1000)		1.0 + (20 + 20000/N _L)
4	HIGH	1000.0 μH	0.2 + 4	10.000 kΩ	0.3 + (2 + 2 N _L /1000)	1.0000	1.0 + (15 + 20000/N _L)
	LOW		0.3 + 6		0.5 + (2 + 2 N _L /1000)		1.0 + (20 + 30000/N _L)

*When reading of L or C is more than 1500 counts.

** ± (% of reading + counts), N_c and N_L are capacitance and inductance readouts in count.

*** Test Level is low on range 4 for C and range 1 for L measurements.

Test frequency: 1 MHz ± 0.01%

Test signal level:

RANGE	C measurement		L measurement	
	HIGH	LOW	HIGH	LOW
1	0.5 V rms ± 10%	20 mV rms ± 10%	2 mA rms ± 20%	2 mA rms ± 20%
2			5 mA rms ± 10%	200 μA rms ± 10%
3			500 μA rms ± 10%	20 μA rms ± 10%
4			20 mV rms ± 20%	20 mV rms ± 20%

Display: dual 4½ digit LED displays.

Ranging: automatic and manual. Remote control with Opt 101.

Measurement terminals: four-terminal pair construction.

Offset adjustment ranges: capacitance ≤ 1 pF, conductance ≤ 1 μS, inductance ≤ 100 nH, resistance ≤ 100 mΩ.

DC bias (optional)

Internal source: available; Opt 001, 00.0 V to 39.9 V, 0.1 V steps.

External source: ± 200 V max to BNC connector.

General

Measuring Speed

Fixed range: 100 ms to 250 ms for C-G and L-R measurement.

160 ms to 400 ms for C-D and L-D measurements.

Autorange: 100 ms/range step added to above values.

Power: 100/120/220 V ± 10%, 240 V ± 5% - 10%, 48-66 Hz, 80 VA max.

Size: 88 mm H x 425 mm W x 496 mm D (3½" x 16¾" x 19½").
Weight: 10 kg (22 lb).

Accessory furnished: 16038A Test Fixture for radial and axial lead components.

Ordering Information*

16021A Calibration Test Fixture (GR900 connector) \$765

16022A General Purpose Test Fixture \$625

16023A DC Bias Voltage Controller (used with Opt 001) \$665

16032A Test Leads (BNC) \$265

16033A Test Leads with miniature coaxial connectors \$290

16034A Test Fixture for chip capacitor measurement \$550

16039A Test Fixture with "D" offset. \$385

Opt 001: DC Bias supply; 0.0 V to 39.9 V add \$330

Opt 002: C/L BCD output; may be used with Opt 003 for simultaneous outputs +8421 Code add \$165

Opt 003: G/R/D BCD output. +8421 Code (see Opt 002) add \$165

Opt 004: Parameter Serial BCD output add \$300

Opt 101: HP-IB Data Output and Remote Control add \$945

Opt 908: Rack Flange Kit add \$25.00

Opt 910: Extra manual add \$40

4271B 1 MHz Digital LCR Meter \$6735

*HP-IB cable not supplied. See page 30.

COMPONENT MEASUREMENT

Preset C Meter

Model 4272A (1 MHz), Model 4273A (1 kHz)



- Simultaneous go/no go check on production line

- High speed measurements

4272A
1 MHz
PRESET
C METER

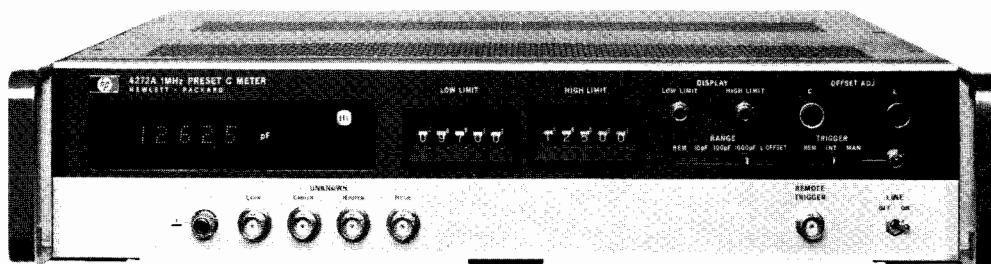

4273A
1 kHz
PRESET
C METER

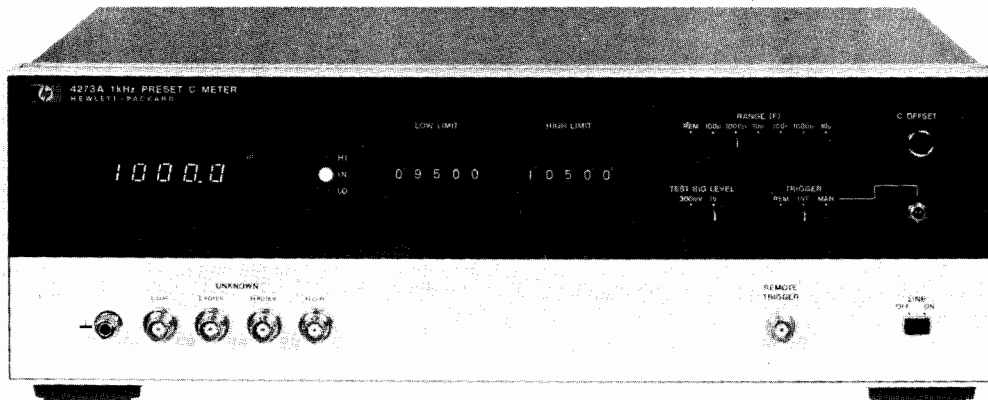

Hewlett-Packard's 4272A and 4273A are Preset C Meters which measure capacitance at 1 MHz and at 1 kHz, respectively, and which, combined with a 5 digit "in-house" comparator, provide GO/NO GO information for high speed measurements up to 8 per second (4272A) or 6 per second (4273A) with high reliability and accuracy. A basic accuracy of 0.1% is achieved by the four-terminal-pair method and an offset adjustment to reduce measurement error due to test fixture configuration. This provides high efficiency for production line testing or incoming inspection.

The 4272A measures capacitance from 10 pF full scale (0.001 pF

resolution) to 1000 pF full scale (maximum display 1900 pF), and the 4273A measures capacitance from 100.0 pF full scale (0.01 pF resolution) to 10 μF full scale.

With their comparator capabilities, the instruments can be set to high and low limits with the built-in thumbwheel switches. Limit indications include panel lamp display, relay contact and TTL outputs for HI, IN and LO comparisons. TTL outputs are provided on the rear panel connector for use with an automatic sorter and BCD output of measurement data is also provided. For higher sorting speeds, a high speed version Opt HO1 is available.

Specifications

Model		4272A			4273A		
Parameter measured		Capacitance—equivalent parallel circuit by four terminal pair method					
Test signal frequency & level		1 MHz; 1 Vrms			1 kHz; 1 Vrms and 300 mVrms		
Range & accuracy	Range	10.000 pF	100.00 pF	1000.0 pF	100.00 pF - 10.000 μF		
	Digit & overrange	4 digit, overrange 90%				4 digit, overrange 20%	
	Accuracy*	0.1 + 7	0.1 + 3	0.1 + 2	0.1 + 3		
	Conditions	23°C ± 5°C at D < 0.1. * ± (% of reading + counts)					
Comparator function		Compares measured value with HI and LO LIMIT settings and provides HI, IN and LO comparison outputs.					
HI and LOW LIMIT setting ranges		00000 - 19999 at each limit switch			00000 - 11999 at each limit switch		
Comparison output		Lamp, relay contacts and TTL outputs					
Digital output		BCD 1-2-4-8 data parallel (option)			BCD 1-2-4-8 data parallel (furnished)		
Remote programming		TTL and contact closure					
Measuring time		<120 ms. (high speed option: <50 ms 4 digit display, 0.2% accuracy)			<150 ms. (high speed option: <75 ms 3 digit display, 0.2% accuracy)		
General	Power	100/120/220/240 V ± 10% 48-66Hz ≤ 60 VA			100/120/220/240 V ± 10% 48-66 Hz ≤ 25 VA		
	Size	88 mm H x 426 mm W x 467 mm D (3 3/8" x 16 3/4" x 19 1/2")			147 mm H x 426 mm W x 349 mm D (5 3/4" x 16 3/4" x 13 3/4")		
	Weight	Approximately 10 kg (22 lbs)			Approximately 8 kg (17.5 lbs)		

Options Available

002: BCD and Decision Outputs

006: BCD Remote Control

H03: High Speed Version (4 Digit Display, < 50 ms)

Opt 908: Rack Flange Kit

4272A 1 MHz Preset C Meter

add \$105

add \$155

Price on

Request

add \$25

\$6035

Options Available (4273A)

Opt 006: BCD Remote Control

Opt H01: Hi Speed Version (3 digit display, < 75 ms)

4273A 1 kHz Preset C Meter

\$100

Price on

Request

\$3665

COMPONENT MEASUREMENT

Q Meter

Model 4342A

- Frequency range: 22 kHz to 70 MHz
- Q range: 5 to 1000

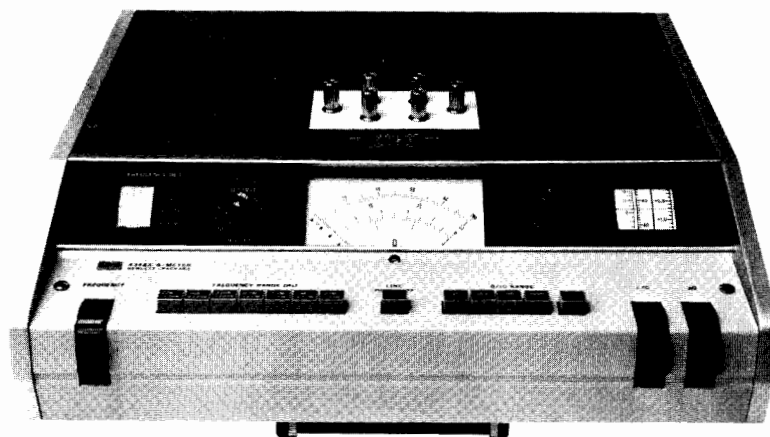

Description

The direct-reading expanded scale of the 4342A permits measurement of Q from 5 to 1000 and readings of very small changes in Q resulting from variation in test parameters. The 4342A is solid state with the elimination of specially matched, fragile thermocouple components.

The 4342A will measure dissipation factor and dielectric constant of insulating materials. The Q meter can measure coefficient of coupling, mutual inductance, and frequency response of transformers. RF resistance, reactance, and Q of resistors and capacitors can also be determined.

Push button operation of frequency range and Q/ Δ Q range selection provides straightforward measurement. Automatic indication of meter scales, frequency dials and frequency multipliers are featured, adding to simplicity and reading speed.

Specifications

RF Characteristics

RF range: 22 kHz to 70 MHz in 7 bands: 22 to 70 kHz, 70 to 220 kHz, 220 to 700 kHz, 700 to 2200 kHz, 2.2 to 7 MHz, 7 to 22 MHz, 22 to 70 MHz.

4342A Opt 001: 10 kHz to 32 MHz in 7 bands: 10 to 32 kHz, 32 to 100 kHz, 100 to 320 kHz, 320 to 1000 kHz, 1 to 3.2 MHz, 3.2 to 10 MHz, 10 to 32 MHz.

RF accuracy: $\pm 1.5\%$ from 22 kHz to 22 MHz; $\pm 2\%$ from 22 MHz to 70 MHz; $\pm 1\%$ at "L" point on frequency dial.

4342A Opt 001: $\pm 1.5\%$ from 10 kHz to 10 MHz; $\pm 2\%$ from 10 MHz to 32 MHz; $\pm 1\%$ at "L" point on frequency dial.

RF increments: approximately 1% resolution.

Q Measurement Characteristics

Q range: 5 to 1000 in 4 ranges: 5 to 30, 20 to 100, 50 to 300, 200 to 1000.

Q accuracy: % of indicated value: (at 25°C)

Q	4342A & 4342A Opt. 001		4342A
	22 kHz-30MHz		30 MHz-70 MHz
5-300	± 7		± 10
300-600	± 10		± 15
600-1000	± 15		± 20

Q increments: upper scale: 1 from 20 to 100; lower scale: 0.5 from 5 to 30.

Δ Q range: 0 to 100 in 4 ranges: 0 to 3, 0 to 10, 0 to 30, 0 to 100.

Δ Q accuracy: $\pm 10\%$ of full scale.

Δ Q increments: upper scale: 0.1 from 0 to 10; lower scale: 0.05 from 0 to 3.

Inductance Measurement Characteristics

L range: 0.09 μ H to 1.2 H, direct reading at 7 specific frequencies.

L accuracy: $\pm 3\%$ after substitution of residuals (approx. 10 nH).

Resonating Capacitor Characteristics

Capacitor range: main dial: 25 to 470 pF; vernier dial -5 to $+5$ pF.

Capacitor accuracy: main dial: $\pm 1\%$ or 1 pF, whichever is greater; vernier dial ± 0.1 pF.

Capacitor increments: main dial: 1 pF from 25 to 30 pF; 2 pF from 30 to 200 pF; 5 pF from 200 to 470 pF; vernier dial: 0.1 pF.

General

Rear Panel Outputs

Frequency monitor: 170 mV rms min. into 50 Ω .

Q analog output: 0 to 1 V ± 50 mV dc after 15 minutes warmup, proportional to meter deflection. Output impedance approximately 1 k Ω .

Over limit signal output: contact closure at the rear panel. Relay contact capacity 0.5 A/15 VA.

Over limit display time: selectable, 1 s or continuously on, after limit exceeded.

Temperature range: 0°C to 50°C.

Power: 115 or 230 V $\pm 10\%$, 50-400 Hz, 25 VA max.

Size: 129 mm H x 425 mm W x 414 mm D (5 $\frac{1}{16}$ " x 16 $\frac{3}{4}$ " x 16 $\frac{1}{16}$ ")

Weight: net, 14 kg (31 lb). Shipping, 18.45 kg (41 lb).

Accessories available:

HP 16014A: Series Loss Test Adaptor is designed for measuring low-value inductors and resistors and high-value capacitors.

HP 16462A: Auxiliary Capacitor is designed to extend the Q and L measurement capability of the 4342A Q Meter. It is especially useful for measuring small inductors at low frequencies.

HP 16470A Reference Inductors: A range of 20 inductors (any of which can be supplied separately) which can be used with the 4342A Q Meter when measuring the RF characteristics of capacitors, resistors, or insulating materials.

HP 16470B Stable Inductors: A set of 4 inductors (any of which are separately available) which can be used to compensate indicated Q values and/or instrumental variation in the maintenance of the 4342A Q Meter. They are useable over a range of 800 kHz to 50 MHz with excellent long-term temperature stability.

Options and Accessories

Opt 001: Frequency Range

Price

add \$240

Opt 910: Extra Manual

add \$21

16014A Series Loss Test Adaptor

\$90

16462A Auxiliary Capacitor

\$440

16470A Reference Inductors, set of 20

\$1200

16470B Stable Inductors, set of 4

\$810

16470C Complete set of 24 Inductors (16470A + 16470B)

\$2000

4342A Q Meter

\$4100

- 20 $\mu\Omega$ resolution on 1 m Ω range
- Four terminal measurement
- Low test voltage

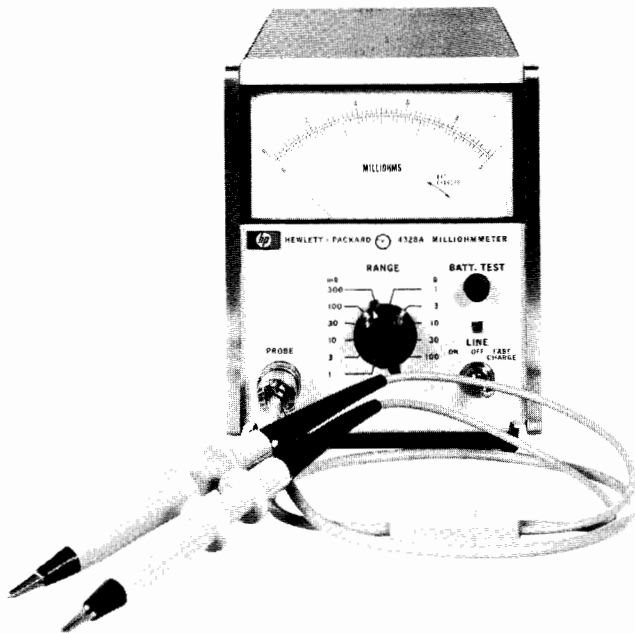

4328A

Description

HP's 4328A Milliohmmeter is a high sensitivity portable instrument for measurement of low resistances. The 1 m Ω to 100 Ω measuring range and 20 $\mu\Omega$ resolution make the 4328A ideal for measuring the contact resistance of switches, relays, and connectors and the resistivity of conductors and semiconductors. Series reactances of up to twice the full scale resistance will not affect the accuracy. The maximum voltage across a sample, with the instrument at the proper range, is less than 200 μ V peak. Even at incorrect range settings, the voltage across the sample will not exceed 20 mV peak.

The special probes that allow four-terminal measurement in two probes are furnished with the 4328A.

The basic 4328A is line operated but Opt 001 permits operation from rechargeable batteries for 15 continuous hours.

Specifications

Range: 0.001 to 100 ohms full scale in a 1, 3 sequence.
Accuracy: $\pm 2\%$ of full scale. No additional error is caused by series reactance of samples up to two times full scale.
Measuring frequency: 1000 Hz ± 100 Hz.
Voltage across sample: 200 μ V peak at full scale.
Maximum voltage across sample: 20 mV peak.
Superimposed dc: 150 V dc maximum (external source).
Recorder output: 0.1 V dc output at full scale, output resistance approx. 1k Ω .
Applied current (mA): Constant by range, 150/(full scale value in milliohms).

General

Power requirements: 115/230 V $\pm 10\%$, 50 to 60 Hz, 1.5 VA.
Weight: 3.2 kg (7 lb).
Size: 155mm H x 130 mm W x 279 mm D (6 $\frac{3}{32}$ " x 5 $\frac{1}{4}$ " x 11").
Accessories furnished: Model 16005A Probe, 16006A Probe and 16007A/B Test Leads. 16143A Probe Cable.

Ordering Information

4328A Milliohmmeter \$1465
Opt 001: Rechargeable battery operation \$90
Opt 910: extra manual \$15.00

- Touch and read operation
- Low test voltage
- Guarded measurement

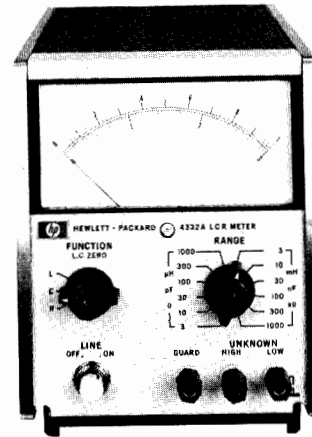

4332A

Description

Hewlett-Packard's Model 4332A LCR Meter measures inductance, capacitance, and resistance with speed and accuracy. The instrument provides direct-readings of L, C, and R with linear meter scales. The 4332A is extremely useful for measurements of both linear and non-linear components such as semiconductor capacitor values and inductance of coils with ferrite core.

Specifications

Function	Full Scale Range	Test Signal	Accuracy (meter reading) at 25°C
Inductance (series)	3 μ to 1000 μ H	100kHz $\pm 5\%$ <1.5mVrms	+ [1% reading + (1.5 + 3/Q)% full scale + 0.03 μ H]
	3m to 1000mH	1kHz $\pm 5\%$ <1.5mVrms	
Capacitance (parallel)	3p to 1000pf	100kHz $\pm 5\%$ ≈ 70 mVrms	\pm [1% reading + (1.5 + 3/Q)% full scale + 0.03pF]
	3n to 1000nF	1kHz $\pm 5\%$ ≈ 70 mVrms	
Resistance	3 Ω to 1M Ω	1kHz $\pm 5\%$ <1mVrms	\pm [0.5% reading + 2% full scale + 0.03 Ω]*

*Add 0.5% reading in 100 k Ω and 1 M Ω ranges.

Analog output: 1.0 V dc or 0.3 V dc full scale.

Output impedance: approximately 500 Ω .

Accuracy: better than meter reading accuracy by 0.5% full scale.

General

Response time: typically 0.25 s for analog outputs. Typically 1.0 s for meter.

Operating temperature: 0°C to 50°C.

DC bias: 100 V dc maximum can be applied from external source.

Power: 115 V/230 V $\pm 10\%$, 48 Hz to 66 Hz, 8VA.

Size: 130 mm W x 155 mm H x 279 mm D (5 $\frac{1}{8}$ " x 6 $\frac{3}{32}$ " x 11").

Weight: net, 3.5 kg (7 lb 11 oz).

Accessories furnished: 16138A Test Leads, Power Cord 8120-1348.

Ordering Information

Accessories available: 16019A Test Fixture \$145
4332A LCR Meter \$1820
Opt 910: extra manual \$1.00

COMPONENT MEASUREMENT

High Resistance Meter

Model 4329A

- Wide range: 500 k Ω to 2 x 10¹⁶ Ω

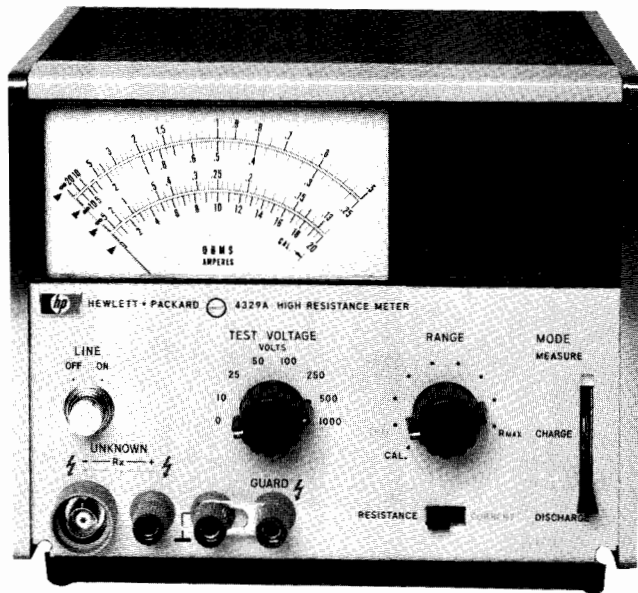

Description

The HP 4329A is a solid-state insulation resistance meter designed for easy, accurate and direct readings of the very high resistance values typically found in synthetic resins, porcelain, insulating oils and similar materials. It is also useful for measurements in electrical components like capacitors, transformers, switches and cables. Seven fully regulated dc test voltages (between 10 and 1000 V) are provided as test sources.

Selected scales are identified by illuminated indicators on the meter face. Selected resistance or current multiplying factors are also illuminated for rapid, error-free measurement. Three resistance scales and one current scale are provided. The HP 4329A is instantly convertible from ungrounded-to-grounded-sample operation via a simple relocation of the front panel ground strap from "guard" to "+" position. The instrument cabinet itself is always at ground potential. Test voltage shorts or sample breakdown currents will not damage instrument circuitry.

The HP 4329A also has a current measurement capability. Minute currents as low as 0.05 pA can be readily measured. The standard instrument package includes HP 16117A Low Noise Test Leads; these are used in most types of measurement.

Use of the HP 16008A Resistivity cell alters the HP 4329A's measurement accuracy. However, the measurement error is consistent and repeatable. This is true as long as the measurement set-up is not changed.

4329A Specifications

Resistance Measurement

Range: 500 k Ω to 2 x 10¹⁶ Ω .

Accuracy: total accuracy is determined by test voltage and range used. At low resistance end of each scale, accuracy is $\pm 3\%$, near center scale $\pm 5\%$, and near the specified upper limit on the meter scale (see table below), accuracy is $\pm 10\%$. Accuracy is not specified above these limits. On all voltage ranges, if multiplier is set to Rmax., an additional $\pm 3\%$ is included.

- Selectable test voltages: 10 V to 1000 V

Current Measurement

Range: 5 x 10⁻¹⁴ to 2 x 10⁻⁵ A in 8 ranges.

Meter scale: 0 to 20 in 40 linear divisions.

Input resistance: 10⁴ to 10¹¹ Ω $\pm 1\%$, depending on range.

Accuracy: $\pm 5\%$ of full scale deflection (there can be an additional $\pm 3\%$ error at the top decade).

General

Recorder output: 0 to 100 mV dc, proportional to meter deflection; 1k Ω output resistance.

Power: 115/230 V $\pm 10\%$, 50-60 Hz, approximately 3 VA.

Size: 166 mm H, 198 mm W, 224 mm D (6¹/₂" x 7²⁵/₃₂" x 8²⁵/₃₂").

Weight: 3.5 kg (7.7 lb).

Accessory furnished: HP 16117A Low Noise Test Leads.

Accessory available: Model 16008A Resistivity Cell.

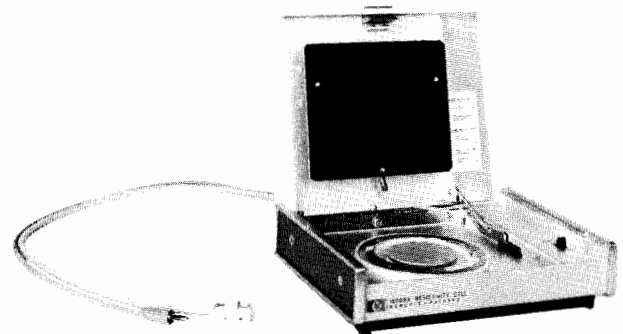

16008A Description

The HP 16008A can safely, rapidly and conveniently measure the volume and surface resistivity of sheet insulation materials. Conversion from volume to surface resistivity measurement requires operation of one switch only; no lead interchange or disconnection is necessary. Designed for use with the HP 4329A Resistance Meter (other voltage supplies and picoammeters may be used), the complete system allows direct measurement of volume resistivity up to approximately 4 x 10¹⁵ Ω c-m (on samples 0.1 cm thick)—and surface resistivity up to approximately 4 x 10¹³ Ω . Test voltages up to 1000 V may be used.

16008A Specifications

Inner electrode: 50 mm diam.

Guard electrode: 70 mm diam.

Auxiliary electrode: 100 mm x 120 mm.

Maximum sample size: 125 mm x 125 mm x 7 mm.

Maximum test voltage: 1000 V dc.

Size: 49 mm H, 198 mm W, 152 mm D (2" x 7¹³/₁₆" x 6¹/₈").

Weight: 1.8 kg (4 lb).

Ordering Information

16008A Resistivity cell

4329A High resistance meter

Opt 910: extra manual

Price

\$750

\$1975

add \$15

Test voltage	10 V	25 V	50 V	100 V	250 V	500 V	1000 V
Available resistance readings	5 x 10 ⁵ Ω to 2 x 10 ¹⁴ Ω	1.25 x 10 ⁶ Ω to 5 x 10 ¹⁴ Ω	2.5 x 10 ⁶ Ω to 1 x 10 ¹⁵ Ω	5 x 10 ⁶ Ω to 2 x 10 ¹⁵ Ω	1.25 x 10 ⁷ Ω to 5 x 10 ¹⁵ Ω	2.5 x 10 ⁷ Ω to 1 x 10 ¹⁶ Ω	5 x 10 ⁷ Ω to 2 x 10 ¹⁶ Ω
Meter scale	.5 to 20	.125 to 5	.25 to 10	.5 to 20	.125 to 5	.25 to 10	.5 to 20
Upper limit	5	1.25	2.5	5	1.25	2.5	5

*Accuracy of test voltage is $\pm 3\%$



4260A

4260A Description

Measurements of C, R, L, D and Q are easily made with Hewlett-Packard's Model 4260A Universal Semi-Automatic Impedance Bridge.

Nulling is easily accomplished with a unique auto-balance circuit. Illuminated pointers (<CRL>) automatically indicate whether a null is up- or down-scale. Both range and CRL controls can be set watching these pointers.

Components may be biased by connecting a battery to rear terminals. An external oscillator and detector can be used for measurements in the 20 Hz–20 kHz range.

Specifications

Model		4260A			4265B	
Full scale ranges	C	1000 pF to 1000 μF, 7 ranges			1000.0 pF to 1000.0 μF, 7 ranges	
	L	1000 μH to 1000 H, 7 ranges			1000.0 μH to 1000.0 H, 7 ranges	
	R	10 Ω to 10 MΩ, 7 ranges			1000.0 mΩ to 1.0000 MΩ, 7 ranges	
Range	C	1 pF to 1 nF	1 nF to 100 μF	100 μF to 1000 μF	all ranges except —	1000.0 μF range only
	L	1 μH to 1 mH	1 mH to 100 H	100 H to 1000 H	all ranges except —	1000.0 H range only
	R	10 mΩ to 10 Ω	10 Ω to 1 MΩ	1 MΩ to 10 MΩ	all ranges except —	1000.0 mΩ range only
Accuracy (% of reading)		±(2% + 1 digit)	±(1% + 1 digit)	±(2% + 1 digit)	±(0.2% of reading + 0.01% of F.S.)	±(0.4% of reading + 0.01% of F.S.)
D	Range	LOW D (series C)	HIGH D (parallel C)		series C	parallel C
	Accuracy	0.001 to 0.12	0.05 to 20		0.001 to 1	0.1 to 1000
Q	Range	LOW Q (series L)	HIGH Q (parallel L)		series L	parallel L
	Accuracy	0.05 to 20	8 to 1000		0.001 to 10	1 to 1000
Oscillator		internal: 1 kHz ± 2%, 100 mV rms ± 20% external: 20 Hz to 20 kHz, ≤ 2 V rms.			internal: 1 kHz ± 15 Hz, ≤ 0.4 V rms external: 50 Hz to 10 kHz or dc for R-measurement; ≤ 4 V rms	
DC bias		Voltage ≤ 6 V, current ≤ 10 mA			Voltage ≤ 250 V, current ≤ 10 mA	

General (4260A)

Power: 115 or 230 volts ± 10%, 50–60 Hz, approx. 7 VA.
Size: 166 mm H x 198 mm W x 279 mm D (6.5" x 7.8" x 11").
Weight: Net, 5 kg (11 lb). Shipping, 6.8 kg (15 lb).

Options

Opt 910: Extra Manual

4260A Universal Bridge

Price

add \$11

\$1780

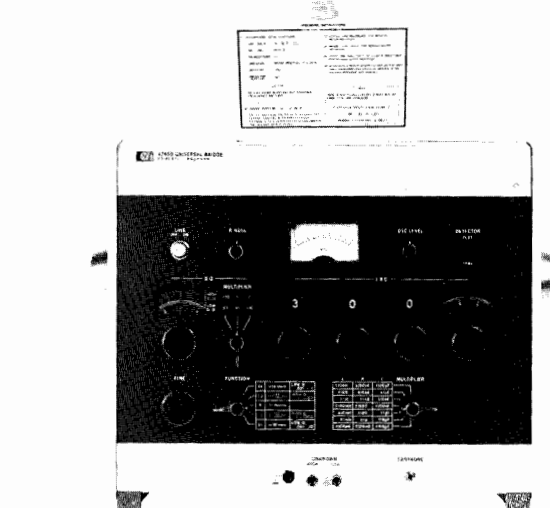

4265B

4265B Description

Hewlett-Packard's Model 4265B Universal Bridge provides an economical way to make precision measurements of L, C, or R and D or Q. Components can be measured in ranges of 0.1 μH to 1111 H in inductance, 0.1 pF to 1111 μF in capacitance and 0.1 mΩ to 1.111 MΩ in resistance with a basic measurement accuracy of 0.2% of reading for L, C, and R.

Measurement frequency range is 50 Hz to 10 kHz with an external oscillator, and 1 kHz with internal oscillator.

General (4265B)

Power: 100/120/200/240 V ± 10%; 48 to 440 Hz, 5 VA.
Size: 376 mm H x 393 mm W x 115 mm D (14.8" x 15.5" x 4.5").
Weight: Net, 5.5 kg (12.1 lb). Shipping, 7.1 kg (15.7 lb).

Ordering Information

16029A Test Fixture

Opt 910: Extra Manual

4265B Universal Bridge

Price

\$160

add \$11

\$1725

COMPONENT MEASUREMENT

Vector Impedance Meters

Models 4800A, 4815A

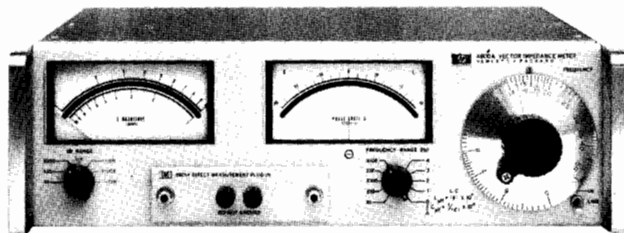

4800A

Model 4800A

HP's 4800A measures the vector impedance of components, complex networks, and other two-terminal devices. Besides measuring vector impedance, the 4800A measures component values. At frequencies that are decade multiples of $\frac{1}{2}\pi$, as marked on the frequency dial, L and 1/C are read directly if the phase is approximately $\pm 90^\circ$, respectively. R is equal to the impedance magnitude at frequencies where the phase is approximately 0° . The vector impedance meter also yields Q and inductor values by using either f_0/Δ , R_p/wL or the wL/R_s technique.

The unit is equipped with analog outputs for three parameters: impedance magnitude, impedance phase, and frequency. The rear panel provision for an external oscillator input makes possible swept frequency characterization of "unknown." The impedance meter can be swept over any decade range of frequency and impedance within the range of the instrument.

Specifications

Frequency Characteristics

Range: 5 Hz to 500 kHz in five bands: 5 to 50 Hz, 50 to 500 Hz, 0.5 to 5 kHz, 5 to 50 kHz, 50 to 500 kHz

Accuracy: $\pm 2\%$, 50 Hz to 500 kHz; $\pm 4\%$, 5 to 50 Hz; $\pm 1\%$ at 15.92 on frequency dial from 159.2 Hz to 159.2 kHz; $\pm 2\%$ at 15.92 Hz.

Impedance measurement characteristics: 1 ohm to 10 megohms in seven decade ranges from X1 to X10M. Accuracy is $\pm 5\%$ of reading.

Phase angle measurement characteristics: 0° to $\pm 90^\circ$ in 5° increments. Accuracy is $\pm 6^\circ$.

Direct capacitance measurement capabilities: 0.1 pF to 10,000 uF direct reading at decade multiples of 15.92 Hz. Accuracy $\pm 7\%$ of reading for D less than 0.1 at 159.2 Hz to 159.2 kHz; $\pm 8\%$ of reading for D less than 0.1 at 15.92 Hz.

Direct inductance measurement capabilities: 1 uH to 100,000 H direct reading at decade multiples of 15.92 Hz. Accuracy is $\pm 7\%$ of reading for Q greater than 10 from 159.2 Hz to 159.2 kHz; $\pm 8\%$ of reading for Q greater than 10 at 15.92 Hz.

Measuring terminal characteristics: both terminals above ground, ground terminals provided for shielding convenience; binding posts space $\frac{3}{4}$ " at centers.

Waveshape: sinusoidal.

External oscillator requirements: 0.9 V $\pm 20\%$ into 20 k Ω

Recorder Outputs

Frequency: level: 0 to V nom.; source impedance: 0 to 1 k Ω nom.; proportional to frequency dial rotation.

Impedance: level: 0 to 1 V nom.; source impedance: 1 k Ω nom.

Phase angle: level: 0 ± 0.9 V nom.; source impedance: 1 k Ω nom.

Accessories furnished: 13525A Calibration Resistor, 00610A Terminal Shield, Vector Impedance Calculator.

Size: 426 mm W x 133 mm H x 467 mm D (16 $\frac{3}{4}$ " x 5 $\frac{1}{4}$ " x 18 $\frac{3}{8}$ ").

Weight: net, 10.8 kg (24 lb); shipping, 13.5 kg (30 lb).

Power: 115 or 230 V $\pm 10\%$, 48 to 440 Hz, 29.7 VA.

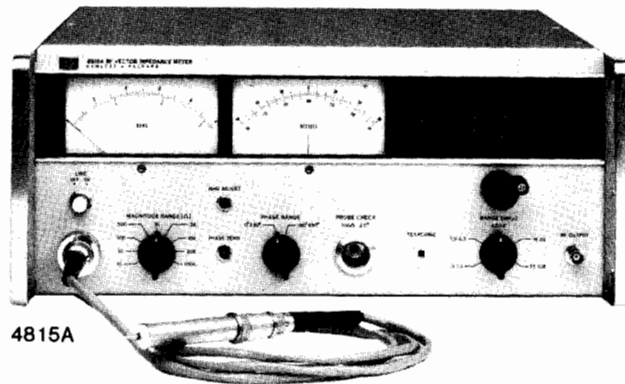

4815A

Model 4815A

The RF Vector Impedance Meter offers these significant advantages:

- Direct reading of impedance and phase
- Convenient probe for in-circuit measurements
- Self calibration check provides measurement confidence
- Analog outputs for data recording
- Low-level test signal minimizes circuit disturbance

The HP 4815A RF Vector Impedance Meter provides all of the convenience of "probe and read" measurements. In use, the probe is connected directly into the circuit to be evaluated, frequency is selected, and complex impedance is read. This type measurement allows a straightforward adaptation to various jigs and fixtures for special measurements. Where only component values are to be determined, a quick-mount adapter is provided to allow rapid measurements. For critical component applications, the unit to be evaluated may be mounted directly in its working circuit and its value determined in its actual environment, at the frequency of interest.

Specifications

Frequency

Range: 500 kHz to 108 MHz in five bands: 500 kHz to 1.5 MHz, 1.5 to 4.5 MHz, 4.5 to 14 MHz, 14 to 35 MHz, 35 to 108 MHz.

Accuracy: $\pm 2\%$ of reading; $\pm 1\%$ of reading at 1.592 and 15.92 MHz.

RF monitor output: 150 mV minimum into 50 ohms.

Impedance Magnitude Measurement

Range: 1 ohm to 100 k Ω ; full-scale ranges: 10, 30, 100, 300, 1 K, 3 K, 10 K, 30 K, 100 k Ω .

Accuracy: $\pm 4\%$ of full scale $\pm (f/30 \text{ MHz} + Z/25 \text{ k}\Omega)\%$ of reading, where f = frequency in MHz and Z is in ohms.

Calibration: linear meter scale with increments 2% of full scale.

Phase Angle Measurement

Range: 0 to 360° in two ranges: $0 \pm 90^\circ$, $180^\circ \pm 90^\circ$.

Accuracy: $\pm (3 + f/30 \text{ MHz} + Z/50 \text{ k}\Omega)$ degrees where f = frequency in MHz and Z is in ohms.

Calibration: increments of 2° .

Adjustments: screwdriver adj. for Magnitude and Phase Zero.

Recorder Outputs

Frequency: 0 to 1 V from 0 to 1 k Ω source, proportional to setting.

Impedance magnitude: 0 to 1 volt from 1 k Ω source.

Phase angle: 0 ± 0.9 volt from 1 k Ω source.

Size: 426 mm W, 185 mm H, 476 mm D (16 $\frac{3}{4}$ " x 7 $\frac{1}{4}$ " x 18 $\frac{3}{8}$ ").

Weight: 17.6 kg (net 39 lb), shipping 24.8 kg (55 lb).

Power: 105 to 125 V or 210 to 250 V, 50 to 400 Hz, 50 W.

Accessories furnished:

00600A Probe Socket Accessory Kit: contains BNC Type "N" adapter. Probe Socket, 00601A Component Mounting Adapter, 2 probe center pins, probe ground assembly.

Options

908: Rack Flange Kit

Price
Add \$22.50

Model Number and Name

4815A RF vector impedance meter

\$6500

4800A Vector impedance meter

\$3900

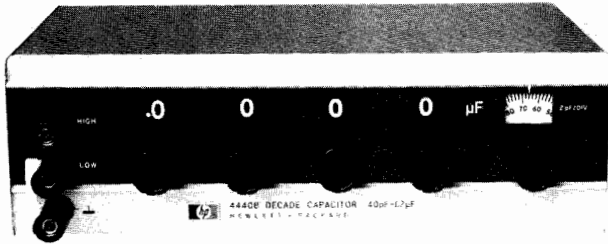

4440B

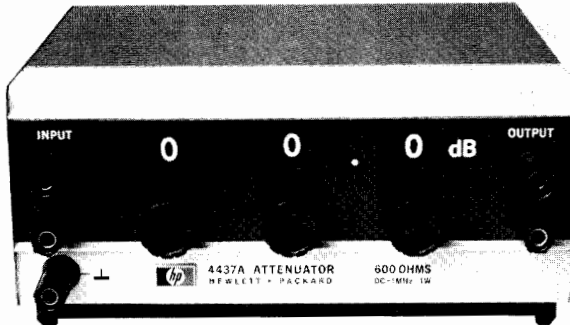

4437A

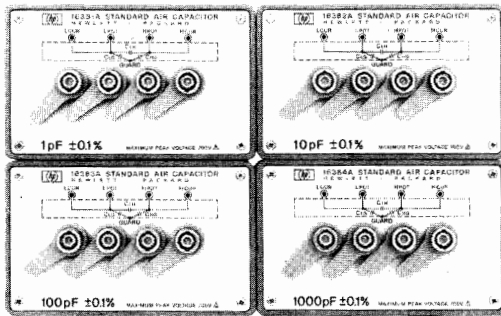

16380A

4440B Description

The Hewlett-Packard 4440B Decade Capacitor is a high accuracy instrument providing usable capacitances from 40 pF to 1.2 μ F. Its 0.25% accuracy makes it an ideal aid for circuit design or as a working standard.

The use of silvered-mica capacitors in all four decades provides higher accuracy, lower dissipation factor and good temperature coefficient. An air capacitor vernier provides 100 pF (from 40 pF to 140 pF) with resolution of 1 pF. Capacitors are housed in a double shield in such a way that increased capacitance from two terminals to three terminals is held to 1 pF.

4440B Specifications

Capacitance: 40 pF to 1.2 μ F in steps of 100 pF with a 40 pF to 140 pF variable air capacitor providing continuous adjustment to better than 2 pF between steps.

Direct reading accuracy: $\pm (0.25\% + 3 \text{ pF})$ at 1 kHz for three-terminal connection.

Resonant frequency: typical values of the resonant frequency are 450 kHz at 1 μ F, 4 MHz at 0.01 μ F and 40 MHz at 100 pF

Dissipation factor: for $C > 1040 \text{ pF}$, 0.001 MAX at 1 kHz.
for $C < 1040 \text{ pF}$, 0.005 MAX at 1 kHz.

Temperature coefficient: $< +70 \text{ ppm}/^\circ\text{C}$.

Insulation resistance: 5 Ω minimum, after 5 minutes at 500 V dc.

Maximum voltage: 500 V peak.

Weight: net 2.5 kg (5 1/2 lb); shipping 3.6 kg (8 lb).

Size: 76 mm H x 264 mm W x 152 mm D (3" x 11" x 6").

4436A/4437A Description

The Hewlett-Packard Models 4436A/4437A Attenuators provide accurate steps of attenuation with 0.1 dB resolution.

4436A Specifications

Maximum attenuation: 119.9 dB.

Attenuation increments: 0.1 dB.

Input/output impedance: 600 Ω , balanced.

Frequency range: dc to 1.0 MHz, usable to 1.5 MHz; dc to 1.5 MHz (0 to 110 dB); dc to 1 MHz (0 to 119.9 dB).

Accuracy:

Attenuation	100 kHz	1 MHz	1.5MHz*
0 to 60 dB	$\pm 0.1 \text{ dB}$	$\pm 0.2 \text{ dB}$	$\pm 0.2 \text{ dB}$
60 to 90 dB	$\pm 0.1 \text{ dB}$	$\pm 0.3 \text{ dB}$	$\pm 0.3 \text{ dB}$
90 to 110 dB	$\pm 0.2 \text{ dB}$	$\pm 0.5 \text{ dB}$	$\pm 0.5 \text{ dB}$
110 to 119.9 dB	$\pm 0.3 \text{ dB}$	$\pm 1.0 \text{ dB}$	

*Typical value

Maximum input power: +30 dBm (24.5 V max).

4437A Specifications

The Model 4437A is a 600 ohms unbalanced type, and its specifications are identical to the 4436A.

DC isolation: signal ground may be $\pm 300 \text{ V}$ dc from external chassis.

Size: 76 mm H x 198 mm W x 177 mm D (3" x 7 3/4" x 6 3/8").

Weight: net, 1.7 kg (3 1/2 lb). Shipping, 2.9 kg (6 1/2 lbs).

16380A Description

The HP 16380A is a set of four air-dielectric four-terminal pair configuration capacitors with values of 1, 10, 100 and 1000 picofarads.

16380A Specifications (at 1 kHz, 23 \pm 5 $^\circ$ C)

	16381A	16382A	16383A	16384A
Capacitance	.1 pF	10 pF	100 pF	1000 pF
Accuracy	$\pm 0.1\%$			
Dissipation Factor	≤ 0.0001			
Dimensions	112 mm (H) 142 mm (W) x 88 mm (D)			
Weight	1.4 kg each, Case: 8.6 kg			

General

Frequency Characteristics

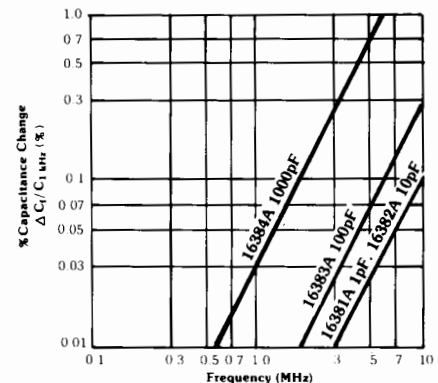

Temperature coefficient (typ.): +40 ppm/ $^\circ\text{C}$ (1pF), +30 ppm/ $^\circ\text{C}$ (10p, 100p, 1000pF)

Calibration accuracy: $\pm 0.01\%$ (certification at 1 kHz supplied).

Stability: 300 ppm/YR (at 1 kHz and 23 \pm 5 $^\circ$ C)

Ordering Information

4440B Decade Capacitor

4436A Attenuator

4437A Attenuator

16380A Standard Air Capacitor Set

Price

\$920

\$1205

\$815

\$2660



COMPONENT MEASUREMENT

pA Meter/DC Voltage Source

Model 4140B

- 3 basic semiconductor measurements:
I, I-V and Quasi-Static C-V measurements
- Two programmable voltage sources
- Basic accuracy: 0.5%
- High resolution: 1.000×10^{-12}
- HP-IB Standard

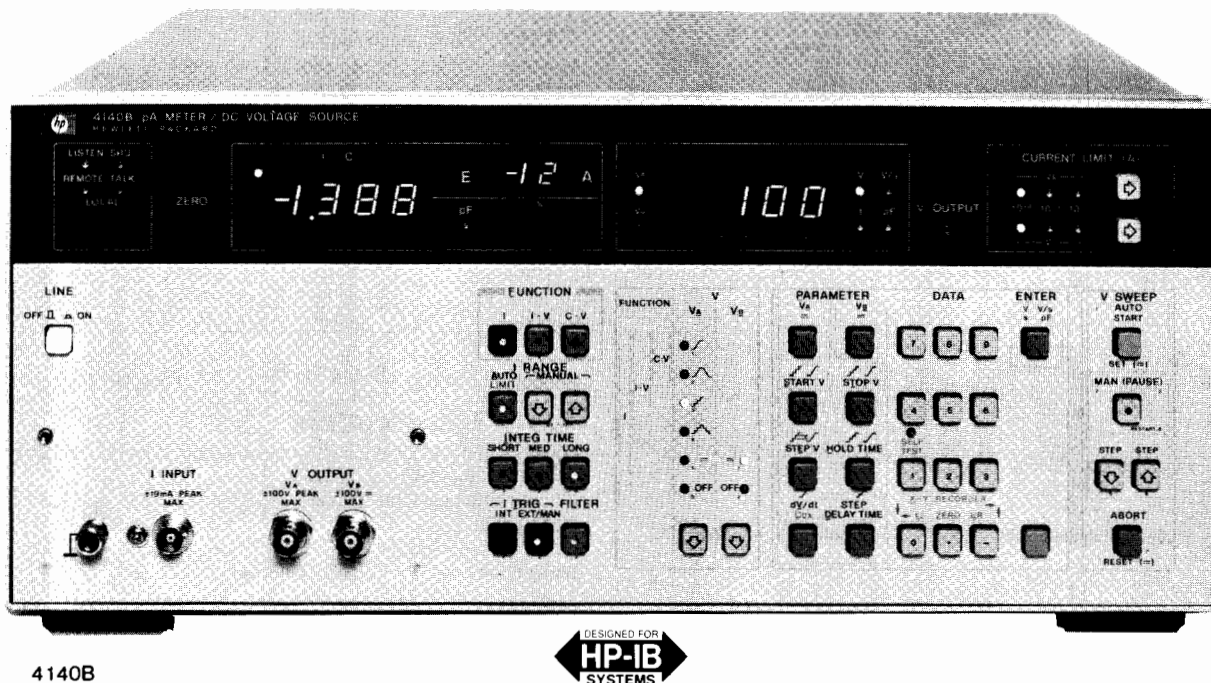

4140B

Description

The 4140B pA Meter/DC Voltage Source is another in Hewlett-Packard's new generation of Component Measurement instrumentation. It consists of an extremely stable picoampere meter and two programmable dc voltage sources, one of which operates as a ramp and staircase generator as well as a dc source. These features make the 4140B ideal for making dc characteristic measurements such as leakage current, current-voltage characteristics and quasi-static C-V measurements required by the semiconductor industry for new product development and for improving production yields. It is equally useful in measurements of electronic components and materials to determine leakage currents or insulation resistances.

The 4140B can contribute to the development, production and quality control of semiconductor devices and to the improvement in the reliability of electronic components and equipment.

Stable pA Measurements

Stable picoampere measurements can be made with the 4140B with a maximum resolution of 10^{-15} A. This is made possible by a new measurement technique in conjunction with an offset current capability, low noise test leads, and an electrostatic and light shielded test fixture. These features provide both stable and fast picoampere measurements.

This measurement technique is very useful in making small leakage current measurements and determining dc parameters of semiconductor devices or measuring the insulation resistance and leakage current for dielectric absorption measurements necessary in the analysis of capacitors or insulation materials.

Synchronized I-V Measurements

The 4140B makes automatic, synchronized current-voltage measurements that have required a large instrumentation system in the past.

The two voltage sources in the 4140B operate over a range of -100 V to $+100$ V with a maximum resolution of 10 mV. One operates only as a stable dc source while the other generates a staircase voltage, a precise ramp or a stable dc level.

By adding precise, programmable timing capability, we can now make fast, accurate I-V and C-V measurements. Device stabilization times, (time between the applied voltage and the subsequent current

measurement) can now be programmed from the front panel of the 4140B or via the HP-IB bus.

Quasi-static C-V Measurements

Automatic quasi-static C-V measurements are easily accomplished by the ramp voltage capability of the 4140B. This measurement is highly significant in evaluating basic semiconductor characteristics.

The 4140B operates over a capacitance range of 0.1 pF to 1999 pF with a dc voltage ramp rate of 1 mV/s to 1 V/s in 1 mV/s increments. Capacitance, which is calculated from the measured current divided by the ramp rate, can also be provided as a percent of the capacitance of the oxide film (C_{ox}) over a range of 0.0 to 199.9% . By providing the output voltage at each capacitance measurement point, we have the dc (quasi-static) C-V characteristics of the device under test.

HP-IB Capability

Interfacing the 4140B to an HP-IB system improves measurement efficiency and takes advantage of its high speed (approx 5 ms) measurement rate. Such a system will minimize measurement time of dc parameters of semiconductors and the insulation resistance and leakage current of electric components and materials. This allows rapid feedback to production for fast evaluation of a new device in the development stage.

Specifications

Measurement functions: I, I-V and C-V

Voltage sources: two separate sources (V_A and V_B)

V_A : ± 100 V programmable source/function generator

V_B : ± 100 V programmable DC voltage source

Measurement Function/Source Selection:

Function	V_A	V_B
I		
I-V		
C-V		

Voltage sweep: auto or manual (pause)

Current measurements:

Displays: current, 3½ digits with 2 digit annunciator. Voltage, 3½ digits.

Measurement range: $\pm 1.000 \times 10^{-12}$ A to 1.000×10^{-2} A full scale in 11 ranges.

Overrange capability: 99.9% on all ranges.

Range selection: auto (lowest current range is selectable), and manual

Measurement accuracy/Integration time:

Range	Accuracy* ± (% of rdg. + counts)	Integration Time** (ms)		
		Short	Medium	Long
$10^{-2} - 10^{-3}$	0.5 + 2	20	80	320
10^{-10}	2 + 2			
10^{-11}	5 + 3	80	320	1280
10^{-12}	5 + 8	160	640	2560

* Accuracy for long integration time. 23°C ± 5°C, humidity ≤ 70%. For short and medium integration time, see reference data section.

** Integration times specified at 50 Hz. For 60 Hz operation, multiple time by %.

Zero offset: cancels leakage current of test leads or test fixtures.

Offset range: 0 to $\pm 100 \times 10^{-15}$ A.

Trigger: INT, EXT and HOLD/MAN

Input terminal: triaxial

Capacitance-voltage (C-V) measurement

Measurement ranges: 0.0 pF – 100.0 pF and 200 pF – 1000 pF F.S. in two ranges; 99.9% overrange

Ranging: auto

%C: capacitance change of device under test is displayed as a percent of the set value of the oxide capacitance ($C_{ox} = 100\%$)

%C range: 0.0% – 199.9%

Cox setting ranges (2 ranges): 0.1 pF – 199.9 pF and 200 pF – 1999 pF

Capacitance calculation accuracy: accuracy is dependent on accuracy of both the current measurement and ramp voltage.

Zero offset: cancels stray capacitances of test fixtures and test leads.



Offset range: 0 to 100 pF

High speed I data output: available with HP-IB interface only. Outputs current measurement data at 4 ms intervals (max rate).

DC voltage sources

Output modes, V_A :

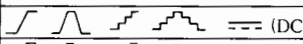
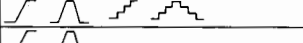
V_B :

Function	V_A	V_B
I		--- (DC)
I-V		--- (DC)
C-V		--- (DC)

Voltage ranges (V_A and V_B): 0 to ± 10.00 V and 0 to ± 100.0 V in 2 ranges, auto range only.

Maximum current: 10 mA, both sources.

Voltage sweep: auto and man (Pause), up/down step in manual (Pause) mode. Sweep abort standard

Operating parameter setting ranges:

Start voltage and stop voltage: 0 – ± 10.00 V, 0.01 V steps; 0 – ± 100.0 V, 0.1 V steps

Step voltage: 0 – ± 10.00 V, 0.01 V steps; 0 – ± 100.0 V, 0.1 V steps

Hold time: 0 – 199.9 seconds in 0.1s increments; 0 – 1999 seconds in 1.0s increments

Step delay time: 0 – 10.00 seconds in 0.01s increments; 0 – 100.0 seconds in 0.1s increments

Ramp rate (dV/dt): 0.001 V/s – 1.000 V/s in 0.001 V/s increments

Accuracy (at 23°C ± 5°C):

Output voltage: ± 10 V, $\pm (0.07\% + 11$ mV); ± 100 V, $\pm (0.09\% + 110$ mV)

Ramp rate: typically 0.5%, 0 – ± 10 V; $< 5\%$, > 10 V.

Current limit: 100 μ A, 1 mA and 10 mA, $\pm 10\%$ (V_A and V_B)

Output terminals: BNC; L-GND

Reference Data

Current Measurement

Current measurement accuracy*

Range	Integration Time	
	Short	Medium
$10^{-2} - 10^{-3}$	0.5 + 3	0.5 + 2
10^{-9}	0.5 + 3	0.5 + 3
10^{-10}	2 + 4	2 + 3
10^{-11}	5 + 10	5 + 4
10^{-12}	5 + 20	5 + 10

* ± (% of rdg. + counts), 23°C

Current ranging times*: 21 ms to 3.8 sec. (longer ranging time needed for large changes in input signal level, especially on lowest current ranges).

*When FILTER is on, current ranging time increases 60 ms (50 Hz power line) or 50 ms (60 Hz power line)

Warm-up time: ≥ 1 hour

Common mode rejection ratio: ≥ 120 dB (≤ 2 counts)

Analog Output I, C and V_A

Accuracy: $\pm (0.5\% + 20$ mV)

Low pass filter: 3 position: OFF, 0.22 s $\pm 20\%$ and 1s $\pm 20\%$ applied to both V_A and I/C data outputs

Pen lift output: TTL low level (≤ 0.8 V) during sweep period in I-V and C-V functions

Recorder output scaling: pushbutton scaling of lower left and upper right limits of X-Y recorder

HP-IB Interface*

Remote controlled functions: measurement function, current range, integration time, I data output trigger, voltage sweep controls, current limit, V_A and V_B voltages, zero (offset), self test and parameter settings (voltages, sweep/hold/delay times)

Data output:

Measured data (I, C and V_A),

Voltage setting (V_A and V_B),

Parameter settings

*HP-IB cables not supplied; see page 30.

General Information

Power: 100, 120, 220, V $\pm 10\%$, 240 V $+5\% - 10\%$; 48-66 Hz, 135 VA max with any option

Size: 426 mm W x 177 mm H x 498 mm D (16.5" x 7" x 19.6")

Weight: 14.4 kg (31.7 lbs.)

Accessories Furnished

16053A test leads: Consists of one triaxial cable, two each BNC-BNC cables and one connection plate with mating female panel-mount connectors. Cables are one meter in length.

16055A test fixture: for general device measurements. Provides electrostatic and light shielding for stable pA measurements.

Accessories Available

16054A connection selector: provides a simple method to select appropriate connection of low lead for the pA meter section.

16056A current divider (10:1): for use only on the 10 mA range to extend the measurement capability to 100 mA.

Ordering Information

Accessories

16053A Test Leads (furnished)

16054A Connection Selector

16055A Test Fixture (furnished)

16056A Current Divider (10:1)

Options

Opt 907 Front Handle Kit (P/N 5061-0090)

Opt 908 Rack Flange Kit (P/N 5061-0078)

Opt 909 Rack & Handle Kit (P/N 5061-0084)

Opt 910 Extra Manual

4140B pA Meter/DC Voltage Source

Price

N/C

\$340

N/C

\$150

add \$40

add \$30

add \$65

add \$40

\$7920

COMPONENT MEASUREMENT

Semiconductor/Component Test System

Model 4061A

- Ready to use—supplied with 7 turn-key application pacs
- Reliable impedance and current measurements with one probing
- Productivity improvement through accurate and fast measurement over wide range

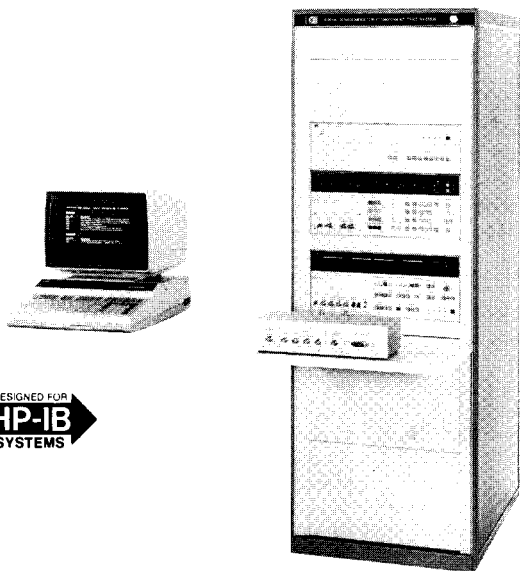

Description

The 4061A Semiconductor/Component Test System is a dedicated system for making efficient, automatic evaluation of the fundamental characteristics of semiconductor and electronic components required in R & D and production areas. This system employs reliable, accurate measurements and high speed data processing to perform more reliable evaluations with speed and less manpower. The 4061A is supplied with 7 sophisticated applications programs and is flexible in both software and hardware. Thus, the system can output measurement results in nearly any required data format.

The switching subsystem, designed especially for use with the 4061A, allows both impedance and current measurement without changing DUT connection. Using this new switching subsystem, and by making impedance measurements, the 4061A performs evaluation of Doping profile, Oxide capacitance, Flat band condition, Threshold voltage, Surface charge, and Minority carrier life time/surface generation velocity. The 4061A also measures leakage current and reverse/forward current-voltage characteristics. Surface state density evaluation, using both high (e.g., 1 MHz) and low frequency (Quasi-static) C-V measurements and data processing are also possible by making modifications to system software.

The system offers significant improvement in both yield and quality in production through fast and reliable measurements and evaluations. It is also a valuable evaluation tool for the development of new materials and devices. The 4061A provides the flexibility to meet the future measurement requirements of the electronics industry.

System Configuration

- The 4061A consists of the following:
- 4140B pA Meter/DC Voltage Source
- 4275A Multi-frequency LCR Meter
- Switching Subsystem
- 9835A System Controller
- 98034A HP-IB Card
- 98035A Real Time Clock
- 29402B 56-inch Rack Cabinet

Impedance Measurement

The 4275A Multi-frequency LCR Meter offers excellent flexibility in measuring the impedance characteristics of semiconductors, LCR components and electronic materials. The 4275A's flexibility enables tests to be performed at test frequencies, test signal levels and DC bias voltage equivalent to, or very near actual operating conditions.

The 4275A offers up to 5½ digit resolution, wide measurement range (0.01 fF to 199,999 μF) basic accuracy of 0.1% over a 10 kHz to 10 MHz frequency range.

Current Measurement

The 4140B pA Meter/DC Voltage Source offers stable current from 0.001 pA to 20 mA. Two programmable ±100 VDC voltage sources are also built in. Fast, accurate I-V characterization of FETS and diodes are made easy using microprocessor timing control between the voltage sources and pico-ammeter. The 4140B also performs reliable quasi-static C-V measurement with high sensitivity and stability by using a highly linear ramp biasing technique.

Switching Subsystem

The switching subsystem remotely changes DUT connection between the 4275A and 4140B. Thus, with one probing, the measurement cabling is automatically controlled and wide measurement range for both impedance measurements, up to 1 MHz, and current measurements, down to 0.001 pA are guaranteed.

This switching subsystem includes an 8 bit data I/O function with 2 bit interrupt input for interface versatility. Non-HP-IB products such as IC probers, temperature controls, or component handlers can be interfaced through this 8 bit I/O. Of course, other HP-IB compatible products can be interfaced, allowing greater flexibility in both measurement and data processing.

Controller

The standard System controller is the HP 9835A with basic 64 k byte memory. The 9835A controls measurements and performs complex data manipulation. The derivation of the semiconductor characterization parameters and general data analysis such as statistical evaluation of the measurement result can be obtained immediately after measurement.

System Software

System software consists of 7 turn-key application programs, 28 system subroutines, and 4 diagnostics. The application software is ready to use to perform basic semiconductor characterizations and component impedance evaluations. System subroutines are usable as major program subroutines to expand system measurement and data processing capabilities. The diagnostics isolate parts of the system not operating properly and can be used to verify system operation before making measurements.

Furnished Application Software

Semiconductor high/low frequency C/V characteristics, I-V characteristics, C-t characteristics and Zernst analysis, Impedance Frequency/Bias characteristics, Ideal C-V curve.

Semiconductor Applications

C-V/G-V Analysis

The 4061A measures the C-V characteristics of MIS structures. Both high frequency C-V (10 kHz to 1 MHz) and low frequency C-V (quasi-static) characteristics are easily measured.

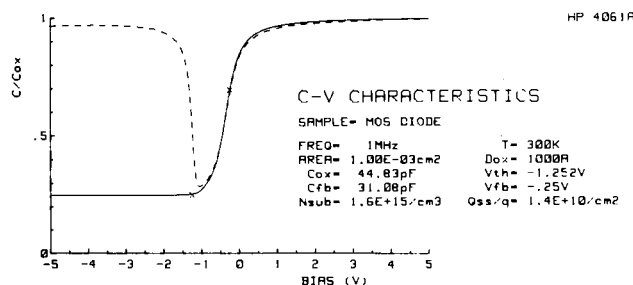

Conductance is simultaneously measured with capacitance so that the G-V characteristics are available for the Nicollian-Goetzberger surface state density analysis $[(Gp/\omega) - \omega]$.



COMPONENT MEASUREMENT

Semiconductor/Comp. Test Sys.

Model 4061A



I-V and DC Characteristics

Total synchronization between the application of the voltage and the current measurement is automatically accomplished by the 4061A. This permits the accurate (0.5%) and high speed (35 ms on the 1 nA range) measurements necessary to measure small leakage currents in MOS structures, FET's, and diode static characteristics.

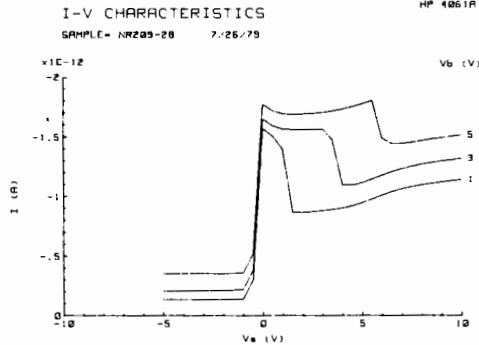

4061A System Library

Specifications

For detailed specifications on each of the instruments used in the 4061A, refer to the individual data sheets.

Impedance Measuring Section (4275A)

These specifications are for the 4275A connected directly to the device-under-test (DUT).

Display: 4½ digits; 5½ digits in high resolution mode

Frequency: 10 kHz to 10 MHz; 10 spot frequencies in a 1-2-4 step sequence.

Oscillator level: 1 mVrms continuously variable into open circuit. Output impedance approximately 100 ohms.

Measurement parameters: C-D•Q•ESR•G, L-D•Q•ESR•G, R-X•B•L•C, |Z|—θ

Measurement ranges:

C: 0.01 fF to 199.99 μF

L: 1 pH to 19.999 H

|Z|, R, X: 0.01 mΩ to 19.999 MΩ

G, B: 0.01 nS to 19.999 S

D: 0.0001 to 9.9999

Q: 0.01 to 9900

Basic accuracy: ±0.1%

Measurement time: Approximately 140 ms to 210 ms

DC Bias (4275A Option 001): 0 to ±35 V, 1 mV maximum resolution.

Current Measurement Section (4140B)

These specifications are for the 4140B connected directly to the device-under-test.

Measurement functions: I, I-V, and C-V. Synchronized measurements of Current-Voltage (I-V) and Quasi-Static (C-V) are automatically performed.

Current measurement:

Display: 3½ digit

Range: ±0.001 x 10⁻¹² A to 1.999 x 10⁻² A

Basic Accuracy: ±0.5%

Measurement Time: approximately 5 ms to 9 s

DC Voltage sources: V_A and V_B

Output mode: V_A; V_B;

Range: Both sources, 0 to ±10 V in 10 mV steps; 0 to ±100 V in 100 mV steps; Ramp Rate, (V_A only), 0.001 V/s to 1 V/s

Capacitance-Voltage (C-V Measurement)

Measurement ranges: 0.0 pF to 199.9 pF and 200.0 pF to 1999 pF F.S. in two ranges; 99.9% overrange.

Switching Subsystem

The switching subsystem consists of a switch control module and switching module with interconnecting cables.

Function: Switches connection from DUT to either Multi-frequency LCR Meter or the pA Meter/DC Voltage source.

System Measurement Range (Only deviations from individual instrument specifications are listed.)

Impedance measurements (4275A)

Frequency range: 1 MHz

Measurement parameters: C-G

Capacitance: ≤200 pF (With D≤0.1)

Accuracy: (Accuracy of 4275A) x 1.5 + ΔC (at 25°C + 5°C).

ΔC = 1.4 x 10⁻³Cxf² (pF) + 5 counts

Conductance: ≤12 mS (D ≤0.1)

*Accuracy: (Accuracy of 4275A) x 1.5 + ΔG (at 25°C + 5°C)

ΔG = 6 x 10⁻³Cxf(S) + 5 counts

*After 1 hour warmup and at DUT terminal of switching module f: frequency in MHz

Cx: Measured capacitance value in pF

At 5°C to 40°C, ΔC and ΔG doubles (Example: Assume Cx = 1000 pF and f = 1 MHz). C = (1.4 x 10⁻³•10³•(1)²) pF + 5 counts = 1.4 pF + 5 counts

Current Measurements (4140B)

Accuracy: (Accuracy of 4140B) x 1.5 + 5 counts

After one-hour warmup and at DUT terminal of switching module

Controller (9835A)

Internal storage: 64k bytes

Dynamic range: 10⁹⁹ to 10⁻⁹⁹, 0, -10⁻⁹⁹ to -10⁹⁹

Internal calculation range: 10⁵¹¹ to 10⁻⁵¹¹, 0, -10⁻⁵¹¹ to -10⁵¹¹

CRT display: 80 characters per line; 25 lines

Data cartridge capacity: 217k bytes

Available Options

Option 001: ±100 V internal dc bias; 4275A internal bias is changed to ±100 V with 0.1 V resolution

Option 002: 1-3-5 frequency step; 4275A frequency steps are in a 1-3-5 sequence

Option 030: European date format; 98035A output format is changed to (day, month, hour, minutes, seconds)

General Information

Operating temperature: 5°C to 40°C

Relative humidity: 70% at 40°C

Power: 100, 120, 220, and 240 V, +5% to 10%, 48 to 66 Hz, 690 VA Max (520 VA without the 9835A)

Size: Rack Cabinet, 535 mm (W) x 1635 mm (H) x 770 mm (D) (21" x 64.4" x 30.3"); 9835A: 384 mm (W) x 358 mm (H) x 496 mm (D) (15" x 14" x 19.5")

Weight: Rack Cabinet, approximately 125 kg (275 lbs.); 9835A, approximately 22.3 kg (49 lbs.); Standard System, approximately 190 kg (417 lbs.)

Ordering Information

Option 001: ±100 V dc Bias for 4275A

Option 002: 1-3-5 Frequency Steps for 4275A

Option 030: European Date Format

4061A Semiconductor/Component Test System

Price

N/C

N/C

N/C

\$44,100

COMPONENT MEASUREMENT

Digital IC Tester
Models 5045A, 5046A

- Tests CMOS, ECL, TTL, DTL
- Printed record of IC failures
- Magnetic card programmable
- Tests IC's to 16 pins-24 pins optional

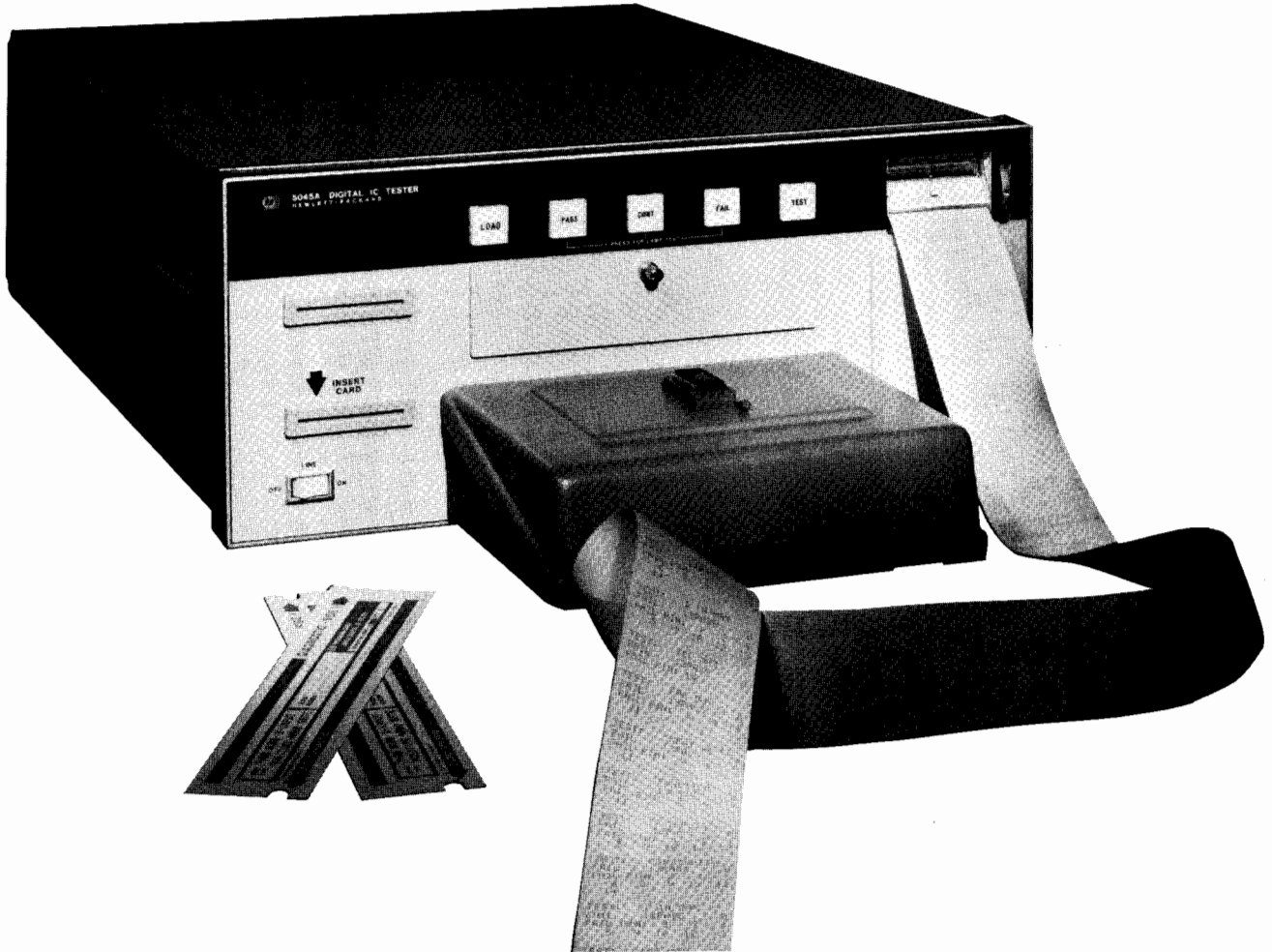

5045A Digital IC Tester

The HP Model 5045A is a processor controlled, microprogrammed digital IC Tester. Well suited for high volume incoming inspection as well as engineering evaluation and failure analysis, it's simple enough to be used by an unskilled operator yet it includes capabilities usually found only in large, computer-based test systems. To test a device, all that's required is a preprogrammed magnetic card. Insert the card into the front panel slot, and the tester is ready to provide complete DC parametric and functional verification of one of the many devices listed in our comprehensive program catalog.

To provide a permanent record of individual IC failures as the test is being made, the quiet HP thermal printer has been included in the 5045A to record detailed failure information for every bad IC. Your operator just keeps on testing—the record is automatically kept and can be reviewed later or returned with the bad IC's to the manufacturer.

Tests All These Families ECL, CMOS, TTL, HTL, DTL

The universal pin electronics in the 5045A let each pin act as power supply, input, output, or open circuit. This provides the great flexibility and capability needed to test circuits all the way from basic gates to arithmetic logic units, and ROM's. Devices with power supply voltages up to 15 volts or both positive and negative voltages up to 7.5 volts may be tested. As your testing requirements expand to new devices, your 5045A can be easily and inexpensively updated by adding

new program cards. The nominal cost of these cards means that you don't have to be satisfied with testing a small fraction of your circuit types. You can keep your program library complete – and still stay within your budget.

DC Parametric and Functional Tests

The 5045A thoroughly tests devices both functionally and parametrically to ensure that those expensive failures don't get loaded into your PC boards. Functional tests check the ability of the device to correctly operate according to its truth table as the appropriate input stimulus is applied. DC parametric tests check the voltages and currents on device inputs and outputs under various conditions specified by the manufacturer. These tests eliminate almost all defective devices and avoid the expense of finding and replacing bad circuits once they have been soldered into PC boards and perhaps become part of a complex system.

Unique Test Technique

To provide the accuracy of direct comparison testing without expensive performance or reference boards, the 5045A uses a unique IC simulation technique. The correct functional operation of the device under test is simulated and this simulation is used as a reference. As both the device under test and simulator are driven with the same inputs, their outputs are compared on a step-by-step basis. If a failure occurs, the 5045A can indicate exactly where it happened by printed message or can stop on the failure so the fault can be investigated in more detail.

Economical ROM Testing

To test the many different truth tables which may be programmed in ROM's of the same generic type, it is not necessary to buy a card for each one. A single card containing stimulus information for the generic ROM type is loaded into the 5045A and the unique truth table of a known good ROM is "memorized" by the 5045A. The complete program is then recorded on a blank card for future use. Duplicates of any card may be made from the original by programming the 5045A, pressing "write", and then inserting a blank card.

Automatic IC Handlers

The 5045A was designed to work with automatic IC handlers needed for high volume testing. The special circuits which generate the fast rise and fall times for testing digital circuits are in a removable test deck which can be placed within inches of the IC being tested. Problems caused by long cables between handler and tester—ringing, oscillation, slow rise/fall times—are eliminated.

HP in cooperation with major automatic handler manufacturers, has designed custom interface kits for popular handlers. So, interfacing the 5045A and a handler requires nothing more than plugging the two together.

Printer Gives Permanent Copy of Test Results

A built-in thermal printer provides useful test information: a) it tells whether a program is loaded correctly and what program it is, b) it records the number of failed and passed IC's, and c) it provides failure analysis information for each failed IC.

In its failure analysis modes, the printer can provide very detailed information; a special voltage/current printout, for example. This makes the printer a digital multimeter PLUS!

Self Test Feature

In an incoming inspection or production environment it is important to know your equipment is operating as it should. The tester has self-test cards to automatically exercise all major circuitry (the drivers and receivers for all pins, the central processor, the memory, and associated circuits). This way, you know every day that the tester is functioning correctly and that none of those bad IC's are getting into your production run, and cutting into your company's profits. Also included are diagnostic cards.

Ordering the Pre-programmed Magnetic Cards

The 5045A is programmed by pre-recorded magnetic cards available from HP. These cards, covering most common device types, are listed in our IC PROGRAM CATALOG. This catalog contains a wide variety of logic families and includes the majority of common device types. When additional programs are needed after the original purchase, they may be ordered through your local HP sales office or by mail with a prepaid coupon.

Each IC program ordered comes complete with both PASS/FAIL and DIAGNOSTIC test cards and includes duplicates of each. The PASS/FAIL test is used for the majority of testing since it is complete and fast (typical test time for MSI sequential devices is 300 ms). The DIAGNOSTIC test provides extra information by supplementing the PASS/FAIL card. Data sheets containing test descriptions and all parameters are included for both PASS/FAIL and DIAGNOSTIC cards.

Condensed Specifications

Test Set-up Method

Test conditions including parametric information, input stimuli and output data contained on magnetic card; program verified when loaded.

Test Structure

Functional test: truth table verified by comparing device under test to software-generated IC simulator (or, stored truth table for some circuits).

Parametric test: DC parameters tested to IC device manufacturers data sheet specs, except where limited by 5045A capabilities. Test limits indicated on sheet sent with each program card.

Continuity test: verifies pin contact by checking current flow in or out of active pins; test failure shown by front panel indicator.

Test Pattern Generation

Test patterns derived using algorithmic techniques or from stored truth tables; tests individually tailored to each IC.

Universal Pin Drivers

Same circuit drives or monitors each pin whether an input, output, power supply, clock or open. Voltages and currents individually programmable for each pin. No external test fixtures required.

Voltage applied to the device under test (Supply Voltage, Input Voltage, and Output Voltage)

Range (15 Volts)	Accuracy
-7.5 V ≤ to < -1.875 V	± 25 mV
-1.875 V ≤ to ≤ +1.875 V	± 15 mV
+1.875 V < to ≤ +7.5 V	± 25 mV

Current applied to the device under test (Supply Current, Input Current, and Output Current)

Range	Accuracy*
-200 mA ≤ to < -2.5 mA	± 0.4 mA or ± 6%
-2.5 mA ≤ to ≤ 2.5 mA	± 10 μA or ± 6%
2.5 mA < to ≤ 200 mA	± 0.4 mA or ± 6%

*whichever is greater

Slew rate: ≥ 33.3 Volts/μs.

Rear panel outputs

Automatic handler interface: 14 pin Amphenol connector provides +5 V @ < 100 mA, "End of Test", "Pass", "Fail", and "Fail Continuity" signals, accepts "Start Test". All signals are negative true TTL levels.

General

Power: 100/120/200/240 V (+5%, -10%), 48-66 Hz, 240 VA.

Size: 19 H x 42.5 W x 58 cm D (7.5" x 16.7" x 22.8").

Shipping weight: 27.7 kg (61 lb.)

Operating temperature: 0°C to 50°C.

Relative humidity: 80%.

Prices

See page 139.

5046A Digital IC Test System

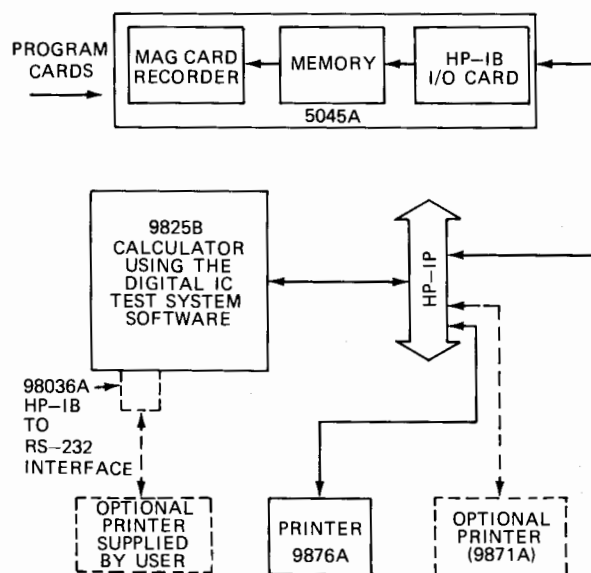

5046A Digital IC Test System Functional Block Diagram



COMPONENT MEASUREMENT

Digital IC Test System

Models 5045A, 5046A (cont)

- Modify existing device programs
- Generate one-of-a-kind device programs
- Change test parameters quickly, simply
- In-house programming—on your own schedule

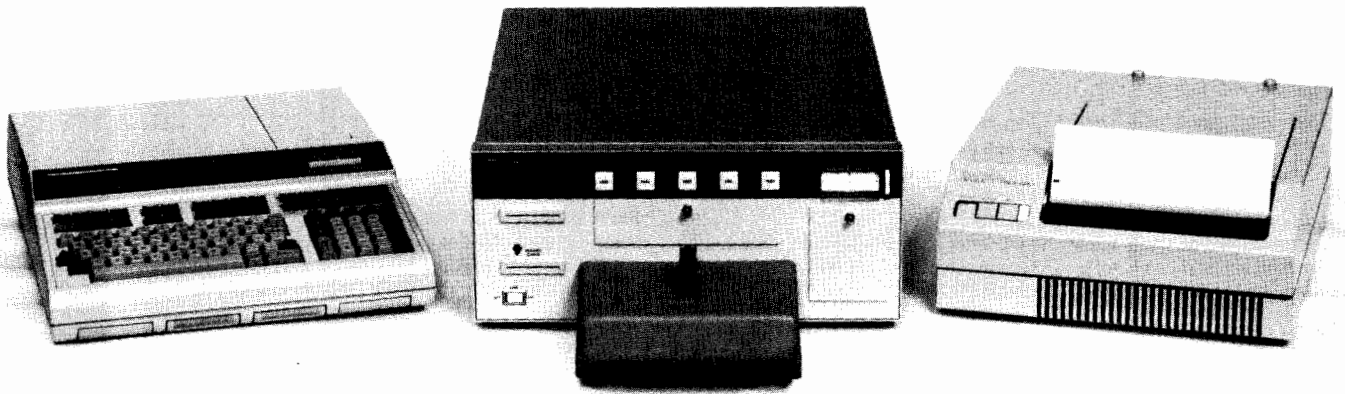

Description

The HP 5046A Digital IC Test System gives you capability previously available only at the factory: the ability to write or change IC test programs to meet your special needs. Also, the 5046A consists of the same equipment used at the factory to generate all of the standard device programs listed in our IC Program Catalog.

Built around the 5045A IC Tester, 9825B Desktop Computer and 9876A Printer, the system allows you to program proprietary devices, change parameters, write your own special programs, or modify existing device programs to meet special testing needs. This helps you to keep information about proprietary devices confidential, it saves time by allowing in-house programming capability, and it allows you to evaluate devices, all by use of an HP-IB based, fully programmable system.

In incoming QA inspection departments, quality control is a key concern. New IC's need to be tested to assure conformance to design requirements—bad or marginal IC's can generate great costs if installed in production equipment, and sometimes IC specifications can change overnight.

The 5046A provides flexibility in these areas because device programs can be changed quickly and simply by a few keystrokes. The user simply loads in the device program, using either a magnetic card or a tape cassette, lists the program, keys in the changes and generates a new program.

The 5046A system is a complete system consisting of hardware and software—it is fully integrated, specified, documented and tested as a

system prior to shipment. For easy on-site installation and verification, full hardware and software manuals are provided. The operating and programming manual, for example, is written to three different levels, each progressively deeper, to enable easy start-up and operation, quick comprehension of the operating system and its hardware, and complete self-instruction on the system software.

Each system requires a printer for operation; the 5046A includes a Model 9876A Thermal Printer as standard equipment, and the Model 9871A Impact Printer is also available as an option (Opt 001). Other RS-232 compatible printers, supplied by the user, can be interfaced to the system in lieu of the 9876A by ordering the HP-IB to RS-232 interface (opt 002).

Software

The 5046A system software is stored on one standard 9825S tape cassette. The programs are accessible using the special function keys on the desktop computer. The software package consists of the following programs:

The **Editor** provides the capability to:

1. Enter IC test programs from the 9825B keyboard.
2. Read in source program from the 9825B cartridges.
3. Modify source programs.
4. Store source programs on 9825B cartridges.
5. Provide on-line editing.
6. Print-out listing of source programs.

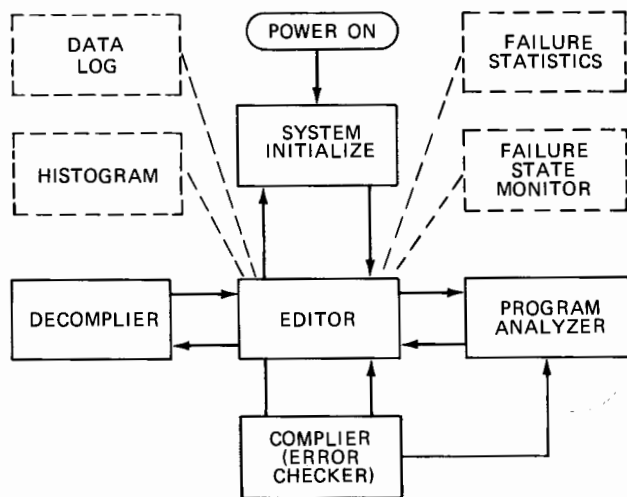

5046A Digital IC Test System Software Organization

The **Compiler** provides the capability to:

1. Do syntax checking on source program statement.
2. Convert the source program into an object (machine code) program.
3. Output the object program to the 5045A IC Tester.

The **Decompiler** provides the capability to:

1. Read an object program from the 5045A IC Tester.
2. Generate the corresponding source program.

The **Program Analyzer** is used for error checking and debugging source program. It interrogates the 5045A processor as it is run through a completed test program, then prints the following:

1. Listing of actual test sequence.
2. Programmed test parameters for each pin in each test.
3. The "1" and "0" logic state for each pin in each test.

The **Failure Statistics** program provides the following:

1. Printout of failure by pin for each specific test failed.
2. Summary of failure and failure percentage for each test in the program.

The **Data Log** and **Histogram** programs provide detailed pin-by-pin voltage and current performance characteristics on IC devices. This provides the ability to carefully evaluate an IC's characteristics and design margins for usability in a company's products. Data is readily available on the 5046A's System printer in a large, readable format.

The **Failure State Monitor** program interacts with the 5045A while an IC is being tested. When a failure is encountered, it displays the state in which the IC failed.

The Operating and Programming Manual provides detailed information and modular program examples that enable the user to quickly and easily learn the 5046A programming language (it isn't necessary to learn the 9825B HPL language in order to generate IC test programs).

To generate an original IC test program, the user need only understand the IC technology of the device under test (DUT) and be able to design simple logic circuits using Boolean techniques.

The manual provides step-by-step instruction for programming. In addition, individual chapters in the manual cover the HP test philosophy and testing techniques used with the TTL, ECL, CMOS and DTL technologies.

Ordering Information

5045A Digital IC Tester: standard 16-pin version; includes self-check and diagnostic cards, 16 and 24 pin dummy IC's and socket adapter. **Price** \$12,250

5046A Digital IC Tester System: basic system includes 5045A IC Tester, 9825B Desk Top computer, 98034A HP-IB Interface Model 9876A, Option 025 Thermal Printer, 10833B HP-IB Cable, a Programming Manual and 40 blank magnetic program cards. **Price** \$28,200

Options and Accessories, 5045A/5046A

Opt 024: expands 5045A capability to 24 pins	Price \$2,400
Opt 025: Flat-Pack adapter for 14, 16 and 24 pin IC	\$225
05045-90003: Card Holder, One Each	\$0.75
05045-90027: Card Holder 50 ea of 05045-90003	\$35
5952-7616: Program Catalog	N/C
9164-0071: blank magnetic PASS/FAIL program card	\$2.80
9164-0072: blank magnetic DIAGNOSTIC program card	\$2.70
9281-0401: 250 foot roll of thermal printer paper for 5045A (minimum order, six rolls)	\$2.67 ea.
10845A: preprogrammed magnetic card for any device listed in the <i>Program Catalog</i> (HP Publication Number 5952-7616) (min. order, 10 programs)	\$25 ea.
10846A: book containing ten coupons, each redeemable for one IC program listed in the <i>IC Program Catalog</i> (HP Publication Number 5952-7616). Coupons are mailed to factory, programs sent by return mail. Coupons expire after two years	\$250
10847A Service Kit: allows fault isolation and rapid repair of the 5045A through board replacement thereby reducing downtime. The kit includes: all CPU boards, two pin-drivers, card reader and interface, printer interface and solenoid, front panel control, diagnostic program card kit and accessories, and carrying case.	\$4,500

Service agreements for the 5045A and 5046A as well as HP's rebuilt board exchange program are available. Contact your nearest HP office for details.

Automatic Handler Options, 5045A/5046A

Opt 004#: interface package for IPT Model 806 automatic IC handler	\$1,600
Opt 005#: interface package for Sym-Tek model 7191ND automatic IC handler and other related models	
Opt 006#: interface package for Daymarc 952/3 automatic IC handler	\$1,600
Opt 007#: interface package for Micro Component Technology Model 2604/8 automatic IC handler	\$1,600
Opt 008#: interface package for Delta Model 8040 ambient naked DIP handler	\$1,600
Opt 009#: interface package for Contrel Model H310 automatic IC handler	\$1,600
Opt 010#: interface package for PAE Model 3033LP naked DIP handler	\$1,600
Opt 013#: interface package for TRIGON Model T2000 multi-size Ambient Test Handler	\$1,600

#: All interface packages include a test head extender cable, an interface board unique to the particular handler, and a cable to supply control signals to the handler.

Options and Accessories, 5045A Only

10844A: programming interface retrofit kit; contains all necessary parts, cables, interface board, and instructions to modify the 5045A for use in the 5046A Digital IC Test System. Programming manual and 40 blank magnetic program cards included.	Price \$2,475
--	----------------------

Options and Accessories, 5046A Only

Opt 001: Substitute Model 9871 impact printer for 9876A and 10833B	-\$475
Opt 002: Substitute 98036 HP-IB to RS-232 interface for 9876A and 10833B	-\$4,140
Opt 125#: Delete Model 9825 desk top computer, 98034A	-\$8,625
Opt 145#: Delete Model 5045A IC Tester from system	-\$12,256
Opt 176: Delete Model 9876A, Option 025, and 10833B HP-IB Cable	-\$4,875

Only one of these options can be on any one order.

CIRCUIT TEST SYSTEMS

Production Testing of Electronic Printed Circuit Board Assemblies

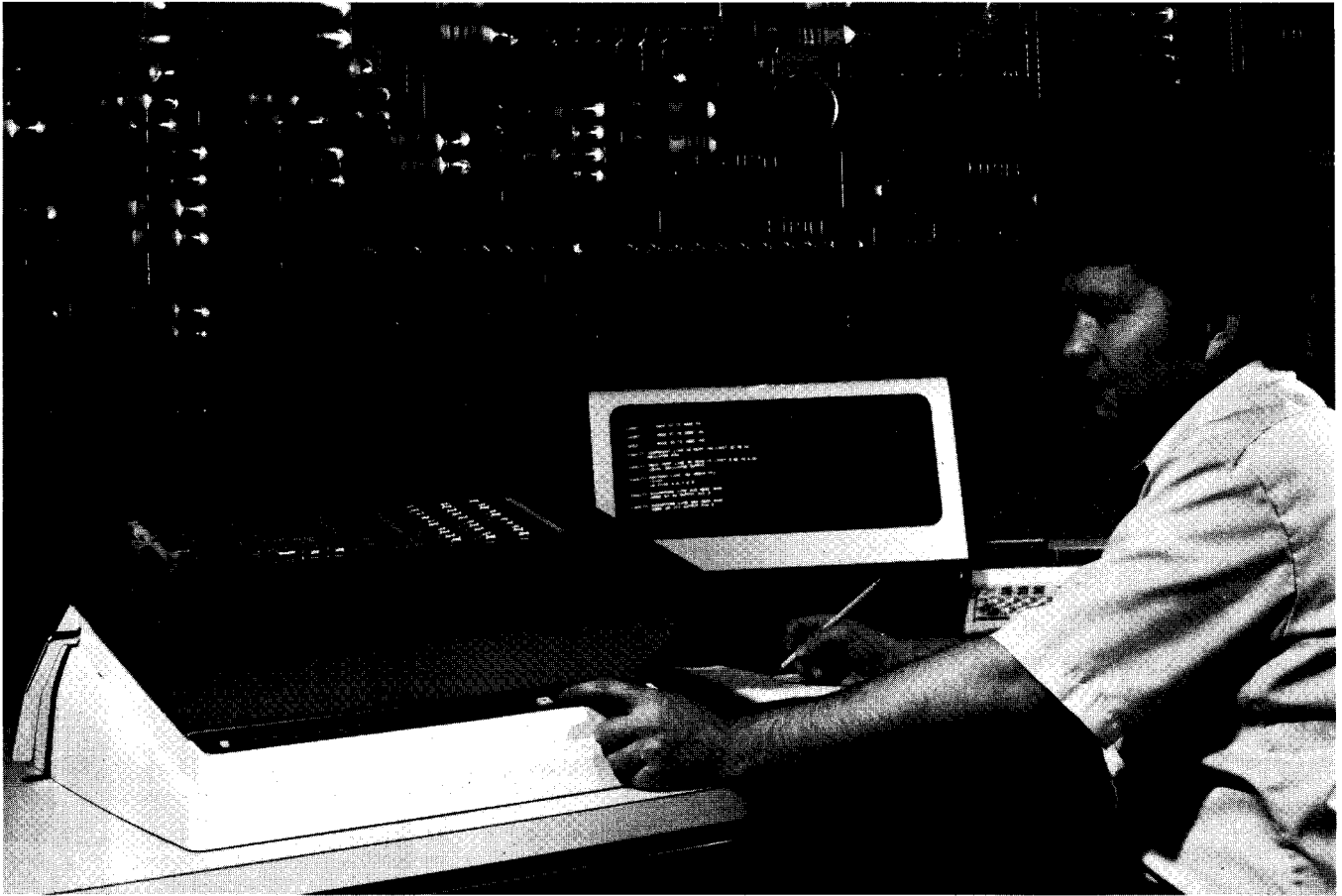

Is automatic testing a panacea? With today's PC volume and complexity, it's not so much a panacea as it is a necessity. But to implement a test solution requires a thorough understanding of the available test systems and your production environment.

When to Test?

That's as important as how. The cost of fault identification increases dramatically with each production step. Thus, you want to catch faults as early in the production process as possible, but it doesn't necessarily follow that extensive incoming parts inspection is the answer. Your real goal is high turn-on rates in final test. That demands high-yield PC boards. And as the diagram below shows, several factors other than good parts go into high-yield PC boards.

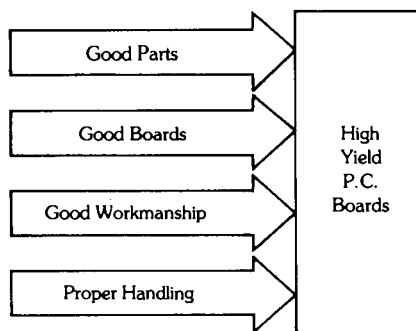

A new set of problems must be dealt with at the board assembly level and cannot be eliminated by 100% incoming inspection. Some of these typical problems are handling breakage, misloaded parts, incorrect parts loaded, soldering problems, PC board problems such as shorted traces, and heat damage to the parts as they are being assembled. It is mainly this factor that determines the amount of cost and manpower that should be devoted to incoming parts inspection.

The objective of these activities is to maximize the probability of system turn-on. Good parts and PC test reduce the problem level at final product test.

A PC board assembly process will produce anywhere from 20% to 80% good boards. A typical number is 60%. Of the faulty boards, a fault spectrum might look like this:

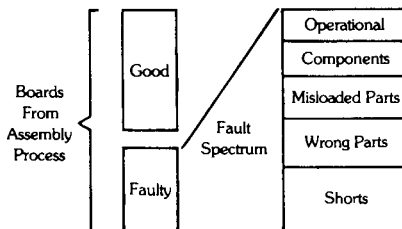

With a good board yield of 60% and no PC board testing, even a simple product with five boards would overload final test. Nine out of

ten units would fail. This makes board level a good place for thorough testing, for this is the first opportunity to locate faults across the entire fault spectrum. But which tester is for you?

Choosing a Circuit Board Tester

There are no simple answers to selecting an automatic circuit test system. But, from our experience, we know that these are some of the factors involved: Production yield, test yield, fault spectrum, PC volume, board type, and anticipated new products.

Will the system test for the spectrum of faults that you will encounter? Will it generate component level diagnostic information? Will it test present and future board types and do it fast? Is it easy to expand and adapt to changing requirements?

What are the true costs? How much time and effort is involved in programming, debugging, fixturing and training? And will you get prompt, competent service if you need it?

Over Two Million Boards Worth of Experience

HP's new Automatic Circuit Test Systems are the result of our extensive in-house experience with automatic circuit testing.

In fact, we were spending such large sums on dedicated equipment and manual test stations that back in 1970 we developed an automatic circuit test system called Optest I. This system, along with its more recent companion, Optest II, is still in operation today.

Optest I and Optest II are now testing over 100,000 printed circuit boards annually. Our new circuit test system is, in reality, a third-generation product, which originated from over eight years' experience in actual in-use operation. Today, HP is using 75 of these new automatic test systems within our own plants.

Balanced Testing

One hundred percent testing at all stages in the production process is expensive and inefficient. A balanced test strategy must be tailored to individual problems and requirements.

Thoughtful consideration of testing requirements will improve product yield and at the same time reduce costs. Other benefits are a smoother production line and lower test and troubleshooting times.

HP's electronic manufacturing experience has led to the development of two major automatic board test products, the HP 3060A and the DTS-70. Each system approaches the problem of PCB testing differently, focusing upon the different types of boards being manufactured. The HP 3060A is a combined in-circuit and functional analog/digital board test system, and the DTS-70 is a simulator based digital board test system.

The Case for In-Circuit Plus Functional Testing

The marketplace has many potential test solutions. You can choose from simple shorts testers to completely automated systems or from testers that measure components in-circuit to functional test systems that verify dynamic performance of complete circuits.

HP's new 3060A Board Test System is an advanced system that combines the latest in-circuit technology with functional testing. It includes a comprehensive software package for fast program development. It is a proven package, which combines ease of use with flexibility to handle tough test problems.

Leverage Product Yield

In-circuit testing is a powerful test approach. But today's complex products require more than in-circuit testing. Higher and higher PC board yields are required to maintain an acceptable product yield in final testing.

The addition of advanced in-circuit test techniques adds that extra increment to your PC board yield as shown below.

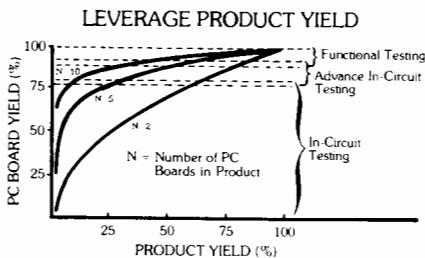

For example, in a five PC board product, increasing the PC board yield from 75% to 98% will leverage product yield from 23% to 90%. This can result in substantial savings,

since the cost of fault detection increases dramatically with each production step.

What Is Advanced In-Circuit Testing?

In-circuit testers contact each PC board node through a bed-of-nails fixture. The system switches from component to component and "inspects" for value, placement, etc. Today, the wide diversity of component values, tolerances, components, and interconnections, means that conventional in-circuit techniques often leave some parameters untested.

The 3060A utilizes advanced techniques that allow component isolation in commonly found but difficult circuit configurations. For example, a .01 μF capacitor can be measured to an accuracy of 4% even when it is shunted by a 1000 Ohm resistor. The key to this measurement is a phase synchronous detector. This is a valuable tool for measuring components and circuits with significant real and reactive characteristics.

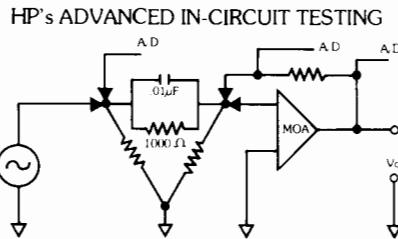

Functional Testing Makes the Difference

The standard HP 3060A also has a useful set of analog and digital testing tools. It incorporates board level stimulus/response testing in order that components such as operational amplifiers, DAC's and optoelectric devices can be tested. This functional testing permits circuit parameters, such as frequency and period, to be measured and circuit adjustments made. The 3060A's functional testing capability extends to digital pattern, analog and combined circuits. For example, the 3060A, can be used to test a D/A converter by applying digital patterns and then monitoring the analog output voltage.

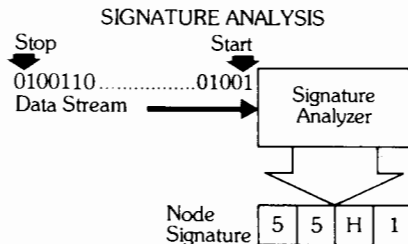

At-Speed Testing of Microprocessor Boards

The big news in PC board testing is the microprocessor. Conventional digital testers do not have the massive data storage required to test microprocessors. But the HP 3060A uses an HP-developed technique called Signature Analysis to test these microprocessor boards at operating speed. The 3060A collects lengthy bit streams at circuit nodes and converts them to short, four-character hexadeci-

mal signatures. Under test, the bit stream signature at each circuit node is compared to the expected value, making it easy to locate nodes with faulty signatures. This data compression technique makes microprocessor-board testing manageable. HP's signature analysis technique is the right solution to testing microprocessor boards.

Digital Test Effectiveness

Some boards, such as large complex logic boards, will benefit from the use of HP's DTS-70 Digital PC Board Test System. This simulator-based tester tells you how effective your test programs are and identifies the portion of the circuit not completely tested. This is important feed-back permitting better program development. A useful tool in R & D, the DTS-70 can model your designs and help you produce better products. Your test engineer will appreciate its ability to model feedback loops, find open traces and identify intermittent faults.

Just as important, the DTS-70's power and flexibility comes from its controller, the HP 1000 Computer System. Using a Real-Time Executive operating system, you can simultaneously test PC boards and develop new programs. As your testing needs expand, two more test stations and several programming terminals can be added without the expense of additional computer power. The operating system is compatible with data-base management software to keep track of your test data and help you better manage your production. The DTS-70 will easily fit into your long range computer network plans providing distributed processing and communication to your data processing center.

	3060A	DTS-70
In-Circuit	X	
Bed-of-Nails	X	
Edge Connector		X
Functional Analog	X	X
Functional Digital	X	X
Signature Analysis	X	
Board Simulator		X
HP-IB	X	X
Controller	HP 9825T	System 1000

The Bottom Line

Can automated PC board test equipment save you money? Again, there are no simple answers. But it has saved us money and chances are it will save you money, too, if any of these conditions exist in your plant: high PC volume, complex boards, production testing backlog, low turn-on rates of complete systems, high in-process inventory costs and high warranty costs.

Your production operation is unique, but we can help you characterize it by comparing the cost of testing, or not testing, at each level to arrive at your best test resource allocation. Let us help you answer these key test questions.



CIRCUIT TEST SYSTEMS

Digital PC Board Test System

Model DTS-70

- High Speed, High Volume Digital Testing
- Isolate Faults Quickly and Easily
- Eliminate Production Bottlenecks

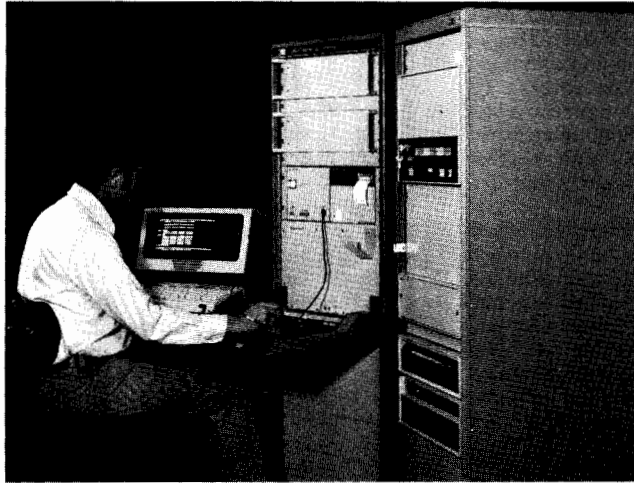

Description

The DTS-70 Digital Printed Circuit Board Test System can solve your digital board testing needs. The DTS-70 can test your boards and isolate faulty components in seconds. Typical tests take only a few seconds and isolation of the failed component typically takes less than a minute. All this testing is performed to a known level of test effectiveness. The TESTAID board simulation software, provided with the system, enables you to model and test the largest and most complex of your digital printed circuit boards and to determine the overall effectiveness of your testing process, a benefit not possible on hardware comparison testers. The FASTRACE fault isolation software guides your test operator to probe for the faulty component quickly and easily, all but eliminating costly manual troubleshooting.

The DTS-70 System is a complete system consisting of the 9571A Test Station, the HP System 1000 computer and a complete software package. The 9571A Test Station comes complete with digital test unit, programmable power for your board under test, and fault isolation probe. The test station is expandable to do added analog testing that may be required. The field proven HP System 1000 includes the 21MX Series E computer and 7906A disc. The HP System 1000 provides both testing and software test generation expandability through the Real Time Executive operating system. The TESTAID simulator software and FASTRACE fault isolation software provide powerful test generation capability and advanced fault isolation which even enables you to isolate intermittent faults.

The DTS-70 is a test system with the capability, expandability, and reliability you expect from HP.

No More Production Down-Time to Develop Test Programs

The multi-terminal capability of the DTS-70 allows you to generate test programs without shutting down testing on your production line. No longer do you have to choose between production shut downs and spending tens of thousands of dollars for off-line test generation capability. All you need is a relatively inexpensive terminal. Need more programming capability to keep up with new boards? Add up to six terminals to the DTS-70 for use as programming stations.

High Speed, High Volume Digital Testing

Test complex boards in only seconds compared to the minutes or even hours necessary for manual test and fault isolation. The DTS-70 is capable of testing tens of thousands of PC assemblies a month for high through-put requirements.

Isolate Faults Quickly and Easily

Troubleshooting and isolation of faulty components is done automatically. The computer instructs your test operator to isolate the fault in seconds using the guided probe. Avoid time-consuming manual fault diagnosis and reduce the need for highly skilled technicians.

Eliminate Production Bottlenecks

The DTS-70 can test those complex boards that are so hard to troubleshoot at your final product test station and which hold up your shipments. The DTS-70 is capable of testing complex boards with over 200 MSI components.

How Effective Is Your Test?

Only a simulator-based tester such as the DTS-70 can tell you how effective your tests are. Testing of complex digital assemblies is difficult and ordinarily does not provide this kind of feedback to the test programmer. As a result, the test programmer does not know when to stop test development. The DTS-70 not only tells you how effective your test is, but also which nodes on the board need further attention. This has improved test quality over manual test generation methods by factors of two or more.

Worldwide Service

The DTS-70 Digital Test System is designed and manufactured by Hewlett-Packard and is backed up by HP worldwide support. HP recognizes that in a high volume production environment, each hour of operation affects a large portion of your profit dollars. When you take delivery of a DTS-70 system, the following support is available to you, worldwide, to keep your system working for you.

Model Your Designs in R & D

Catch costly design and testability problems before they become designed-in problems. The DTS-70 TESTAID simulator software models the behavior of your designs, points out testing trouble spots, and predicts race and hazard conditions to your designers. Simulation at the design stage can prevent marginal designs and designed-in problems from reaching your end-users, preventing high warranty costs or costly on-site repairs.

Installation

Installation services will be provided with each purchase of a DTS-70 Test System. These services consist of site preparation data in advance of system delivery and installation when your system arrives.

Warranty

A complete warranty program covers the complete DTS-70 system for 90 days beyond the system installation date. This warranty provides complete repair service during the warranty period.

Customer Assistance Agreements

For system support beyond the warranty period, Customer Assistance Agreements are offered for hardware support and software support. You may select these services together or you may tailor a service program to match your individual needs. With the exception of extremely remote areas, these support programs are available throughout HP's worldwide service organization.

Training

A digital test programming course is included for customer personnel responsible for developing test programs. This 10-day course teaches system operation, FASTRACE fault isolation and emphasizes use of TESTAID to generate digital test programs. Two enrollments are provided with the purchase of a DTS-70 system.

Documentation

Every DTS-70 System is delivered with a complete set of operating and service documentation. The documentation set includes system level manuals, instrument level manuals, software manuals and quick reference guides.

Field Support Package

For those DTS-70 users who choose to do their own servicing, HP offers special field support packages in the form of service kits that contain replacements assemblies. These service kits are designed to allow a user to support his DTS-70 system. For more information on these field support packages, contact your local HP field engineer.

Ordering Information

DTS-70
(Depends Upon Test Configuration)

Price

Starts At
\$90,000

- Tests Microprocessor Based Boards
- Increase PCB yields
- Advanced in-circuit testing
- Board level analog/digital functional testing
- Reduce production costs



3060A

Description

The 3060A Board Best System combines powerful in-circuit fault isolation with wide range analog and digital functional test capability to maximize P.C. board yields. This system incorporates state-of-the-art measurement processing and interface technology combined with years of internal experience in board testing.

The 3060A combines advanced in-circuit component tests and board level functional stimulus/response tests. This new dimension in testing efficiency allows the testing of Printed Circuit Boards to a higher level of confidence than previously possible in a single operation. Not only is the board handling minimized, but the added expense of two test systems is eliminated. The 3060A provides broad functional testing in its standard configuration. For example, the 3060A can perform functional tests on a digital-to-analog converter using the standard analog and digital functions.

Testing Power

Components and component configurations, which were previously not testable, can now be tested with HP's 3060A. The addition of extended guarding, phase-synchronous detection, and accuracy enhancement make this level of testing possible.

Functional testing is accomplished on the same fixture used to perform in-circuit component measurements. Increased productivity results since boards are handled only once for all tests. Flexibility in analog testing allows the use of standard sources and detectors in the HP 3060A or the addition of external instrumentation for special test requirements. A "bed-of-nails" interface provides direct hardware connection to each node of the board under test. This approach not only provides the necessary visibility for component in-circuit measurements, but simplifies digital testing as well. The response of the circuit to digital stimuli is available at these nodes.

Board Test Sequence

The HP 3060A follows a logical testing sequence which minimizes testing time and reports specific faults. Since the majority of board problems may be detected by shorts and in-circuit testing, these tests are performed first, before power is applied to the board. Thus, cata-

strophic failures caused by applying power to a defective board are avoided. When passive in-circuit faults have been screened and repaired, 3060A test tools may be applied to test analog, digital or hybrid signal processing functions.

The High Speed Digital Functional Test Option

The 3060A High Speed Digital Functional Test Option is designed specifically for testing the latest board designs employing LSI microprocessor and memory technologies. The 3060A provides a programmable dynamic stimulus for data rates up to 2 MHz. Or the 3060A can activate board resident stimulus functions and measure the response of the board under test at rates up to 10 MHz. Board response is evaluated using signature analysis within a unique automated system context.

The flexible, low cost dynamic test hardware is closely coupled to a powerful digital functional test (DFT) software package designed to simplify the development of stimulus and response measurement procedures. The DFT software provides automatic backtracing via in-circuit visibility on the basis of a topological description of the board. If a failure is detected, the fault-isolation software traces the failure to its source and prints a failure message to speed the repair process.

Fast Programming

HP 3060A test programs are written in a powerful, high level language called "BTL". As a further aid, the 3060A provides an in-circuit program generator which automatically converts list of components on the board under test into an editable test program written in BTL. This program generator, called "IPG", automatically applies the 3060A's advanced in-circuit test capability to produce a high quality test with minimum programming time. The "DFT" software, described above, completes the package providing highly automated BTL program generation for complex digital functional testing.

The system controller is the HP Model 9825T. Its high level language, combined with the board test software, produces a totally interactive programming and debugging environment.

3060A Board Test System
(Depends on test configuration)

\$92,500

DIGITAL CIRCUIT TESTERS

Signature Analysis, IC Troubleshooters, Digital Education



Testability—A Growing Problem

Microprocessors have revolutionized many product lines. Products are now smarter, faster, friendlier and more competitive because they take advantage of microprocessor-based control and computation. They are also harder to build, test and troubleshoot. The need to enhance the testability and serviceability of digital products is acute.

Addressing this need, Hewlett-Packard has developed a line of digital circuit test instruments and training tools. Each product complements the other for complete troubleshooting, testing and training solutions. For example, by using Signature Analysis, simplified production test and field service procedures can be provided to isolate digital failures to the exact node. Then the IC Troubleshooters are used to pinpoint the component or process fault causing the problem, making repairs faster and easier. Finally, the Logic Lab and Microprocessor Lab are used to bring production and service personnel up to speed on the latest digital technologies.

Signature Analysis—Finds the Faulty Node

Signature Analysis (SA) is a technique for component-level troubleshooting. A Signature Analyzer detects and displays the unique digital signatures associated with the data at nodes in a circuit under test. By comparing these actual signatures to the correct ones, a troubleshooter can quickly back-trace to a faulty node.

By adding SA capability to the digital portion of a product, manufacturing and depot level service can benefit from the increased speed of troubleshooting individual PC boards or assembled products containing many boards. Experience shows that Signature Analysis reduces the time spent in

troubleshooting the digital portion of a product by at least 2:1. With this reduction in time comes a significant reduction in production and service labor costs. HP offers an extensive Application Note Series 222 outlining the technique and benefits of Signature Analysis.

Signature Analysis Stimulus

There are two ways to provide Signature Analysis stimulus for a product. One way is to add some test features to the product so that it exercises itself. The other way is to provide some source of stimulus that is external to the product.

HP's 5001 series of Microprocessor Exercisers allow products not designed with SA self-stimulus in mind to economically take advantage of the SA technique. These microprocessor exercisers provide a source of external test stimuli for microprocessor-based products.

Signature Analysis Response

The 5004A Signature Analyzer is a compact instrument for troubleshooting microprocessor-based TTL logic systems with Signature Analysis, at speeds up to 10 MHz.

HP's 5005 Signature Multimeter has extended signature analyzer performance along with analog measurement capabilities useful in troubleshooting digital systems. Signature analysis enhancements include variable threshold for multiple logic families, qualified clocking, and 20 MHz operation. A counter, digital multimeter, and dynamic voltage level measurement capability offer a measurement tool optimized for digital troubleshooting.

The IC Troubleshooters—Find the Faulty Component

The IC Troubleshooters have become the "digital screwdrivers" of today's laboratories, production lines, service facilities and

electronic classrooms. They are low-cost, hand-held and have proven very effective in the functional testing and troubleshooting of digital circuits. HP Application Note 163-2, *Techniques of Digital Troubleshooting*, can help put the IC Troubleshooters to work for you.

Logic comparator: the Model 10529A Logic Comparator utilizes comparison techniques to identify faulty nodes in a digital circuit. It tests an IC dynamically, in-circuit, by comparing output responses to those of a known-good IC which is plugged into the Comparator.

Logic probes: detect logic levels at any circuit point and display them via a light at the probe tip. A logic high is indicated by a bright light. A logic low extinguishes the light. A bad level causes a dim light.

Logic clips: are multipin state indicators which clip directly onto ICs. The logic state of each pin is displayed by an individual LED, enabling the user to check the device's truth table.

Logic pulser: pulse stimulation is essential in checking digital logic circuits. Logic pulsers inject digital pulses between gates, without requiring unsoldering of components. They automatically drive low nodes high, or high nodes low, with substantial override current.

Current tracer: often a bad node is identified, but the specific device causing the fault can only be isolated by cutting traces, or replacing circuit elements. The 547A Current Tracer eliminates just such "shotgun" techniques by showing exactly where digital current pulses are flowing in the circuit. Use of current tracing techniques solves the most vexing troubleshooting problems: stuck data buses, solder-bridges, stuck nodes containing many circuit elements, and the wired-AND gate.

Stimulus-response testing: the Pulser/Probe or Pulser/Tracer combination helps the user to identify the faulty circuits causing a system malfunction. These instruments permit signal injection and readout between gates.

Troubleshooting kits: a variety of kits is available, combining IC Troubleshooters for stimulus-response testing. Each kit includes a carrying case, and offers a price saving over the individual instruments.

Education: HP's 5035 Logic Labs and 5036A Microprocessor Lab meet the need for thorough training in digital electronics. Both models are comprehensive hardware, software and hands-on troubleshooting courses.



- Dynamic multi-family logic indicators
- Pulse stretching for narrow pulses
- Bad level/open circuit detection

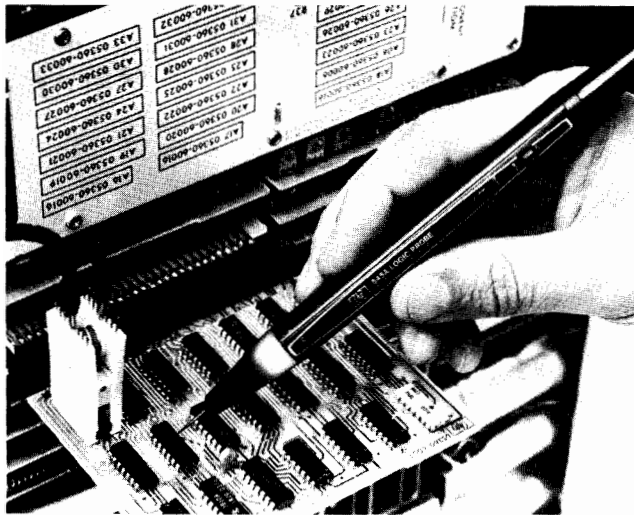

Logic Probes

Logic Probes greatly simplify tracing logic levels and pulses in IC circuits to find nodes stuck HIGH or LOW, intermittent pulse activity, and normal pulse activity. That's because they instantly show whether the node probed is high, low, bad level, open circuited, or pulsing.

Logic Probes require a simple connection to the circuit under test's power supply, and they're ready to use. The strain-relieved power cord, and line-voltage protected tip insure long life and durability. High input impedance protects against circuit loading, not just in the HIGH state, but for logic LOWs as well.

545A TTL/CMOS Logic Probe

The HP Model 545A Logic Probe contains all the features built into other HP probes, plus switch-selectable, multi-family operation and built-in pulse memory. Employing the same straightforward one-lamp display as our other probes, the 545A operates from 3 to 18 volts in CMOS applications or from 4.5 to 15 V dc supplies in the TTL mode while maintaining standard TTL thresholds.

The probe's independent, built-in pulse memory and LED display help you capture hard to see, intermittent pulses. Just connect the probe tip to a circuit point, reset the memory, and wait for the probe to catch those hard to find glitches. The memory captures and retains a pulse until reset.

The hand-held 545A is light, rugged, overload protected, and very fast: 80 MHz in TTL, 40 MHz in CMOS. It also employs handy power supply connectors that enable you to easily hook up to supply voltage almost anywhere in the unit under test.

545A Specifications

Input current: $\leq 15 \mu\text{A}$ (source or sink).

Input capacitance: $\leq 15 \text{ pF}$.

Logic thresholds

TTL: Logic one 2.0 + 0.4, -0.2 V dc. Logic zero 0.8 + 0.2, -0.4 V dc.

CMOS: 3-10 V dc supply

Logic one: $0.7 \times V_{\text{supply}} \pm 0.5 \text{ V dc}$.

Logic zero: $0.3 \times V_{\text{supply}} \pm 0.5 \text{ V dc}$.

CMOS: $\geq 10-18 \text{ V dc supply}$.

Logic ONE: $0.7 \times V_{\text{supply}} \pm 1.0 \text{ V dc}$.

Logic ZERO: $0.3 \times V_{\text{supply}} \pm 1.0 \text{ V dc}$.

Input minimum pulse width: 10 ns using ground lead (typically 20 ns without ground lead).

* $\pm 5 \pm 10\% \text{ V dc power supply}$; usable to $+15 \text{ V dc}$ with slightly increased logic low threshold.

- One lamp, finger-tip display
- Pulse memory capability
- Overload protected

Input maximum pulse repetition frequency:

TTL, 80 MHz. CMOS, 40 MHz.

Input overload protection: $\pm 120 \text{ V}$ continuous (dc to 1 KHz); ± 250 for 15 seconds (dc to 1 kHz).

Pulse memory: indicates first entry into valid logic level; also indicates return to initial valid level from bad level for pulse $\geq 1 \mu\text{s}$ wide.

Power Requirements

TTL: 4.5 to 15 V dc*.

CMOS: 3 to 18 V dc.

Maximum current: 70 mA.

Overload protection: $\pm 25 \text{ V dc}$ for one minute.

Accessory included: Ground Clip (HP Part No. 00545-60105).

10525T Logic Probe

The Model 10525T Logic Probe provides TTL/DTL trouble-shooting at low cost. Ideally suited to 5 volt logic applications, the 10525T has high input impedance, overload protection, and 50 MHz data rate capability.

10525T Specifications

Input impedance: $> 25 \text{ k}\Omega$ in both the high and low state (< 1 low power TTL load).

Logic one threshold: 2.0 V +0.4, -0.2 V.

Logic zero threshold: 0.8 V +0.2 V, -0.4 V

Input minimum pulse width: 10 ns.

Input maximum pulse repetition frequency: 50 MHz.

Input overload protection: ± 70 volts continuous, ± 200 volts intermittent, 120 V ac for 30 seconds, 240 V ac for 10 seconds.

Power requirements: 5 V $\pm 10\%$, -5% at 60 mA, internal overload protection for voltages from +7 to -15 volts. Includes power lead reversal protection.

Accessories included: BNC to alligator clips; ground clip.

ECL Logic Probe

The HP Model 10525E Logic Probe extends time-proven, cost-saving logic probe troubleshooting techniques to high-speed ECL logic.

Operation of the ECL probe is analogous to that of the 10525T except the 10525E's high speed circuitry stretches single shot phenomena so that single pulses as narrow as 5 nanoseconds may be observed.

The 10525E may be powered directly from any -5.2 volt source and its high input impedance minimizes circuit loading.

10525E Specifications

Input impedance: 12 k Ω in both the high and low state.

Logic one threshold: -1.1 V $\pm 0.1 \text{ V}$.

Logic zero threshold: -1.5 V $\pm 0.1 \text{ V}$.

Input minimum pulse width: 5 ns.

Input maximum pulse repetition frequency: 50 MHz (typically 100 MHz at 50% duty cycle).

Input overload protection: ± 70 volts continuous, 200 volts intermittent, 120 V ac for 30 seconds.

Power requirements: -5.2 V $\pm 10\%$ at 80 mA; supply overload protection for voltages from -7 to +400 volts.

Accessories included: BNC to alligator clips, ground clip.

Accessories Available

00545-60104 Tip Kit for 545A Probe

Price

\$50

10525-60012 Tip Kit for 10525T Probe, 10526T Pulser

\$60

10525-60015 Pulse Memory for 10525T Probe

\$240

Ordering Information

545A Logic Probe

\$125

10525T Logic Probe

\$90

10525E Logic Probe

\$220

DIGITAL CIRCUIT TESTERS

Logic Pulsers Models 546A & 10526T

- In-circuit stimulation without unsoldering
- Greatly simplifies digital troubleshooting
- High current, low duty cycle output

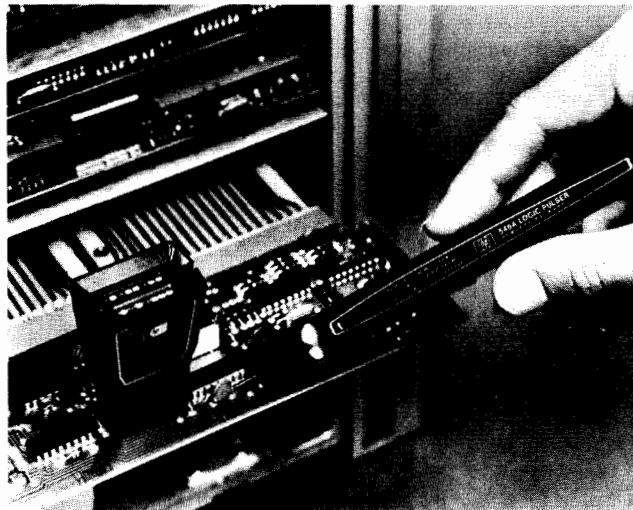

Logic Pulser

The Logic Pulser solves the problem of how to pulse ICs in digital circuits for designers and troubleshooters. Merely touch the Pulser to the circuit under test, press the pulse button and all circuits connected to the node (outputs as well as inputs) are briefly driven to their opposite state. No unsoldering of IC outputs is required. Pulse injection is automatic so the user need not concern himself whether the test node is in the high or low state; high nodes are pulsed low and low nodes, high, each time the button is pressed.

The Pulser is essentially a pulse generator with high output current capability packed in a convenient, easy-to-use probe. Ability to source or sink up to 0.65 Amperes insures sufficient current to override IC outputs in either the high or low state. Output pulse width is limited so the amount of energy delivered to the device under test is never excessive. Additionally, the Pulser output is three-state so that the circuit under test is unaffected until the Pulser is activated.

Combining in-circuit pulse injection with the unique detection capabilities of Logic Probes, Logic Clips, and the 547A Current Tracer helps to focus new power on solving the problems of fault isolation. Pulser/Probe, Pulser/Clip, and Pulser/Tracer combinations enable the digital designer or troubleshooter to hold complete stimulus-response capability at his finger tips.

Gate operation is tested using the Pulser to drive the input while the probe monitors transmitted pulses at the output. When pulses are not received, place the Pulser and Probe on the same pin to detect if the failure is due to a short to ground or V_{cc} .

Testing sequential circuits is the domain of the Logic Clip and Logic Pulser. The Clip simultaneously monitors all output states while the Pulser applies clock and reset pulses to the device. Improper operation, if present is immediately obvious since the IC will not go through its prescribed truth table.

Finally, when Pulsers are used with the 547A Current Tracer, the Pulser acts as a current pulse source to find the exact location of faulty gates on a node, solder bridges, or stuck devices on bus structures.

546A Logic Pulser

Automatic polarity pulse output, pulse width, and amplitude make for easy multi-family operation when you use the 546A Logic Pulser. But, the real surprise comes when you code in one of its six ROM-programmable output patterns (single pulses; pulse streams of either 1, 10, or 100 Hz; or bursts of 10 or 100 pulses). This feature allows you to continually pulse a circuit when necessary, or it also provides an easy means to put an exact number of pulses into counters and shift registers. Used with our multi-family IC Troubleshooters, the 546A acts as both a voltage and current source in digital troubleshooting applications.

- Automatic pulse width
- Automatic pulse amplitude
- Automatic pulse polarity

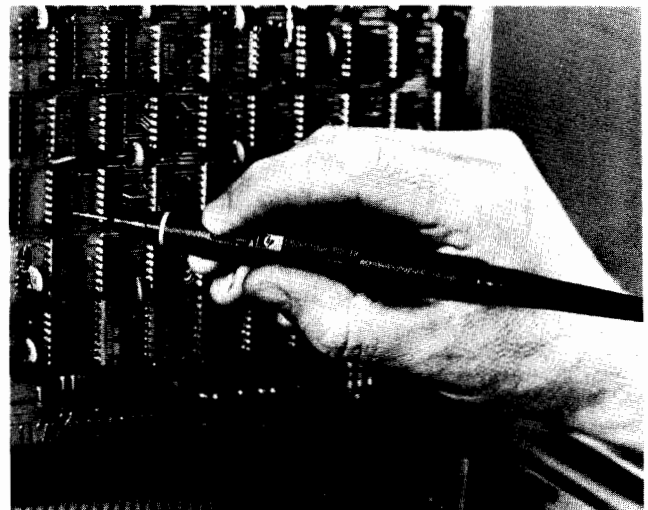

546A Specifications

Output

Family	Output Current	Pulse Width	Typical Output Voltage	
			HIGH	LOW
TTL/DTL	≤650 mA	≥0.5 μs	≥3 V dc	≤0.8 V dc
CMOS	≤100 mA	≥5.0 μs	V(supply) - 1 V dc	≤0.5 V dc

Power supply requirements: TTL; 4.5 to 5.5 V dc at 35 mA, CMOS; 3 to 18 V dc at 35 mA, protected to 25 V dc for 1 min.

10526T Logic Pulser

The economical 10526T provides dependable single-shot operation in TTL/DTL applications. Just press the pulse button, and the pulser delivers a single powerful pulse of the correct pulse width, polarity and amplitude.

10526T Specifications

Output high pulse voltage: > 2 V at 0.65 A (1 A typical at $V_{ps} = 5V, 25^\circ C$).

Output low pulse voltage: < 0.8 V at 0.65 A (1 A typical at $V_{ps} = 5V, 25^\circ C$).

Output impedance, active state: < 2 ohms.

Output impedance, off state: > 1 Megohm.

Pulse width: 0.3 μs nominal.

Input overload protection: ± 50 volts continuous.

Power supply input protection: ± 7 volts (includes power lead reversal protection).

Power requirements: 5V ± 10% at 25 mA.

Accessories included: BNC to alligator clips, ground clip.

Accessories Available

	Price
00545-60104: Tip Kit for 546A Pulser, 545A Probe	\$50
10525-60012: Tip Kit for 10526T Pulser, 10525T Probe	\$60
10526-60002: Multi-Pin Stimulus Kit	\$60

Ordering Information

546A Logic Pulser	\$195
10526T Logic Pulser	\$140

- Troubleshoots three-state buses
- Solves the "Wired-AND" problem
- Displays in-circuit digital current flow

- Pinpoints supply-to-ground shorts
- All family: 1 mA to 1A
- Finger-tip indicator

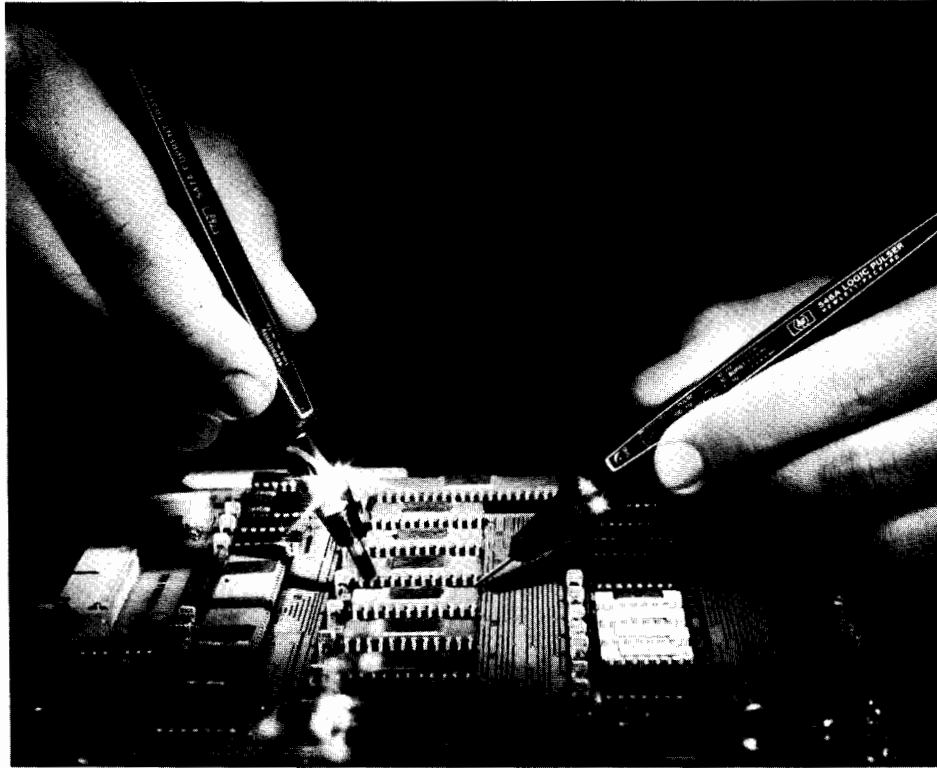

The 547A Current Tracer precisely locates low-impedance faults in digital circuits by locating current sources or sinks. On a shorted node, all points are stuck in one state by the short. Many similar troubleshooting problems such as shorted wired-AND/OR configurations, result in wasted time and excessive costs: several ICs have to be removed before finding the bad one, and in the process the circuit board may be damaged. Now, the 547A exactly pinpoints the one faulty point on a node, even on multilayer boards. In addition, the Tracer locates hairline solder bridges that manage to pass unnoticed until a circuit is operated for the first time.

Constructed as a hand-held probe, the Tracer is a sophisticated instrument designed to troubleshoot circuits carrying fast rise-time current pulses. The Tracer senses the magnetic field generated by these signals in the circuit (or, provided by a Logic Pulser), and displays transitions, single pulses, and pulse trains using a simple one-light indicator. Because it is not voltage sensitive, the Tracer operates on all logic families having current pulses exceeding 1 mA, and repetition rates less than 10 MHz, including CMOS, where even lightly loaded outputs can have up to 2 to 3 mA of instantaneous charging current.

Prior to introduction of the 547A, logic state indicators were limited to displaying voltage information. A node was HIGH, LOW, open, or pulsing. When a node is stuck, however, it may be trying to change state but isn't able to cross threshold levels. Use of the Current Tracer adds the final bit of information necessary to pinpoint just such logic faults on bad nodes. For example, on a bad node the Tracer can verify that the driver is functioning and also show where the problem is by

tracing current flow to the source or sink causing the node to be stuck.

To use the Tracer, simply align the dot on its tip at a reference point, usually the output of a node driver. Set the sensitivity control to indicate the presence of AC current activity. Then, trace the circuit to see where current is flowing. As you probe from point to point or follow traces, the lamp will change intensity, and when you find the fault the Tracer will indicate the same brightness found at the reference point.

547A Specifications

Input

Sensitivity: 1 mA to 1 A.

Frequency response: light indicates single-step current transitions; single pulses ≥ 50 ns in width; pulse trains to 10 MHz (typically 20 MHz for current pulses ≥ 10 mA).

Risetime: light indicates current transitions with risetime ≤ 200 ns at 1 mA.

Power Supply Requirements

Voltage: 4.5 to 18 V dc.

Input current: ≤ 75 mA.

Maximum ripple: ± 500 mV above 5 V dc.

Overvoltage protection: ± 25 Vdc for one minute.

547A Digital Current Tracer

\$400

DIGITAL CIRCUIT TESTERS

Logic Clips
Models 548A & 10528A

- Displays IC logic states at a glance
- Self-powered, self-contained
- See up to 16 pins at a glance
- Easily verifies device truth table

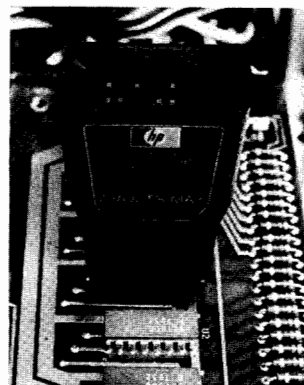

Logic Clips

The Logic Clip is an extremely handy service and design tool which clips onto dual-in-line-package (DIP) ICs, instantly displaying the states of up to 16 pins. Each of the clip's 16 LEDs independently follows level changes at its associated pin. Lit diodes are logic High, extinguished diodes are Low.

The Logic Clip's real value is in its ease of use. It has no controls to set, needs no power connections, and requires practically no explanation as to how it is used. The clip has its own gating logic for locating ground and V_{cc} pins and its buffered inputs reduce circuit loading.

The Logic Clip is much easier to use than either an oscilloscope or a voltmeter when you are interested in whether a circuit is in the high or low state, rather than its actual voltage. The Clip, in effect, is 16 binary voltmeters, and the user does not have to shift his eyes away from his circuit to make the readings.

The intuitive relationship of the input to the output—lighted diodes corresponding to high logic states—greatly simplifies the troubleshooting procedure. The user is free to concentrate his attention on his circuits, rather than on measurement techniques. Also, timing relationships become especially apparent when clock rates can be slowed to about 1 pulse per second.

When used in conjunction with the Logic Pulser, the Logic Clip offers unparalleled analysis capability for troubleshooting sequential circuits. The Clip attaches to the IC to be tested: the Pulser is then used to inject pulses between gates allowing it to supply signals to the IC under test absolutely independent of gates connected to the IC. All outputs may then be observed simultaneously on the Logic Clip. Deviations from expected results are immediately apparent as the Pulser steps the IC through its truth table.

548 Multi-family Logic Clip

Fully automatic, protected to 30 V dc, and employing bright individual LEDs in its display, the 548A brings multi-family operation to

the HP line of IC Troubleshooters. The Clip can be externally powered, if desired, using a simple power connector.

548A Specifications

Input threshold: $(\geq 0.4 \pm 0.06 \times \text{Supply Voltage}) = \text{Logic High}$.

Input impedance: 1 CMOS load per input.

Input protection: 30 V dc for 1 minute.

Supply voltage: 4-18 V dc across any two pins.

Auxiliary supply input: 4.5 to 20 V dc applied via connector. Supply must be ≥ 1.5 V dc more positive than any pin of IC under test.

Supply current: < 55 mA.

10528A Logic Clip

Protection to +7 V dc, automatic operation, and low circuit loading in TTL/DTL applications helps make the 10528A a valuable replacement for more expensive test equipment like scopes and voltmeters. The clip is, in effect, like 16 binary voltmeters, allowing the user to look at the circuit rather than having to shift his attention toward test equipment.

10528A Specifications

Input threshold: 1.4 ± 0.6 V; TTL or DTL compatible (except gates with expander inputs).

Input impedance: one TTL load (-1.2 mA typical) per input.

Input protection: voltages < -1 V or > 7 V must be current limited to 10 mA.

Supply voltage: 5 V $\pm 10\%$ across any two or more inputs.

Maximum current consumption: 120 mA.

Ordering Information

548A Logic Clip

10528A Logic Clip

Price

\$200

\$145

- Finds faulty nodes
- Dramatically cuts troubleshooting time
- Performs in-circuit IC testing with no unsoldering

- Easy-to-use comparison technique
- Versatile "socket board" included for seldom-tested IC's

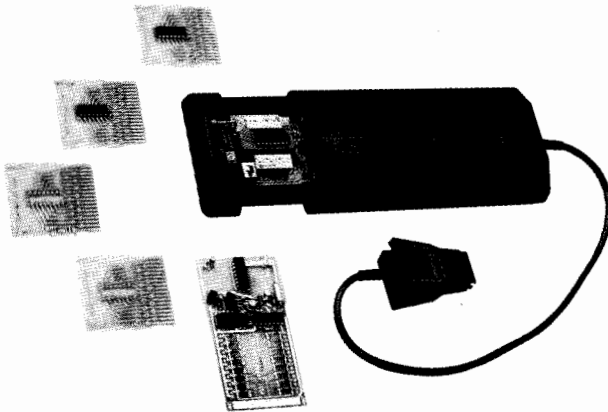

The Model 10529A Logic Comparator checks the operation of dozens of ICs in less than a minute per IC. The Comparator clips onto powered TTL or DTL ICs and detects functional failures by comparing the in-circuit test IC with a known good reference IC inserted in the Comparator. Any logic state difference between the test IC and reference IC is identified to the specific pin(s) on 14- or 16-pin dual in-line packages on the Comparator's display. A lighted LED corresponds to a logic difference. The Logic Comparator can save considerable time in locating a faulty IC. There are no controls to be set and no power connections.

The procedure is very simple. First the IC to be tested is identified. An IC of the same type is placed in the Comparator's IC socket, or a reference board with an IC of the same type is inserted in the Comparator. The Comparator is clipped onto the test IC, and an immediate indication is given if the test IC operates differently from the reference IC. Even very brief dynamic errors are detected, stretched, and displayed.

The 10529A operates by connecting the test and reference IC inputs in parallel; thus the reference IC is exercised by input signals identical to those of the test IC. The outputs of the two IC's are compared; any differences in outputs are detected, and LEDs corresponding to the particular pin are lit on the Comparator's display. Intermittent errors as short as 300 nanoseconds (using the socket board) are detected, and the error indication on the Comparator's display is stretched for a visual indication. A failure on an input pin, such as an internal short, will appear as a failure on the IC driving the failed IC; thus a failure indication actually pinpoints a malfunctioning node.

Programming for the specific IC is easily accomplished by two different methods. First, the socket board included with the Comparator is inserted in the Comparator drawer. Outputs of the particular IC to be tested are selected via 16 miniature switches which tell the Comparator which pins of the reference IC are inputs and which are outputs. The reference IC is then inserted into the socket and locked into place. An IC may be set up in seconds. Alternatively, if specific IC types are to be tested repeatedly, the reference IC may be soldered into one of the 10 reference boards provided with the Comparator. The reference board is programmed by opening the connections between the tests and reference ICs outputs and solder-bridging V_{cc} and ground.

When troubleshooting you want to know that the tester is operating properly. A test board is supplied with the Logic Comparator for this purpose. When inserted in the comparator the test board exercises all of the circuitry, test leads, and display elements to verify proper operation.

The Logic Comparator's ease of use and small size make it an invaluable addition to the troubleshooter's test gear either in the field or in the factory. With TTL and DTL failures that are functionally related, the Comparator can find bad nodes many times faster than conventional signal tracing techniques. At its low price, the Logic Comparator can pay for itself in days.

10541A: twenty additional blank reference boards; identical to the 10 boards provided with the Logic Comparator, they allow additional ICs to be programmed for Comparator testing.

10541B: twenty preprogrammed reference boards; 20 of the most common TTL ICs already programmed and ready for use with the Logic Comparator. The 10541B includes the following ICs: 7400 Quad 2-input NAND; 7402 Quad 2-input NOR; 7404 Hex inverter; 7408 Quad 2-input AND; 7410 Triple 3-input NAND; 7420 Dual 4-input NAND; 7430 8-input NAND; 7440 Dual 4-input NAND buffer; 7451 Dual 2-wide, 2-input AND-OR-INVERT; 7454 4-wide, 2-input AND-OR-INVERT; 7473 Dual J-K master-slave flip-flop; 7474 Dual D flip-flop; 7475 Quad bistable D latch; 7476 Dual J-K flip-flop with preset and clear; 7483 4-bit binary full adder; 7486 Quad 2-input exclusive-OR; 7490 Decade counter; 7493 4-bit binary counter; 74121 Monostable multivibrator; 9601 Monostable multivibrator, retriggerable.

10529A Specifications

Input threshold: 1.4 V nominal (1.8 V nominal with socket board), TTL or DTL compatible.

Test IC loading: outputs driving Test IC inputs are loaded by 5 low-power TTL loads plus input of Reference IC. Test IC outputs are loaded by 2 low-power TTL loads.

Input protection: voltages < -1 V or > 7 V must be current limited to 10 mA.

Supply voltage: 5 V \pm 5%, at 300 mA.

Supply protection: supply voltage must be limited to 7 V.

Maximum current consumption: 300 mA.

Sensitivity

Error sensitivity: 200 ns with reference board or 300 ns with socket board. Errors greater than this are detected and stretched to at least 0.1 seconds.

Delayed variation immunity: 50 ns. Errors shorter than this value are considered spurious and ignored.

Frequency range: maximum operational frequency varies with duty cycle. An error existing for a full clock cycle will be detected if the cycle rate is less than 3 MHz.

Accessories included: 1 test board; 10 blank reference boards; 1 programmable socket board; 1 carrying case.

Accessories Available

Accessories Available	Price
10541A: Twenty Blank Reference Boards for the Logic Comparator	\$100
10541B: Twenty Pre-programmed Boards for the Logic Comparator	\$195

10529A Logic Comparator **\$575**

DIGITAL CIRCUIT TESTERS

Logic Troubleshooting Kits

Models 5011T, 5015T, 5021A, 5022A, 5023A & 5024A

- Complete multi-family kits
- Stimulus-Response capability
- In-circuit fault finding



10529A

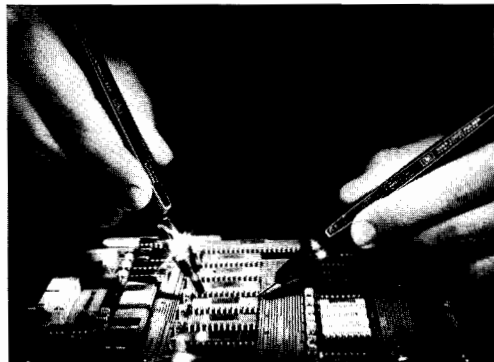

547A/546A

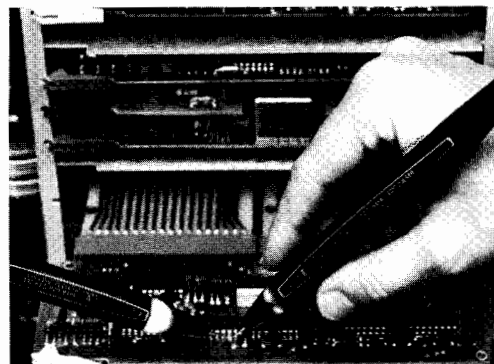

545A/546A

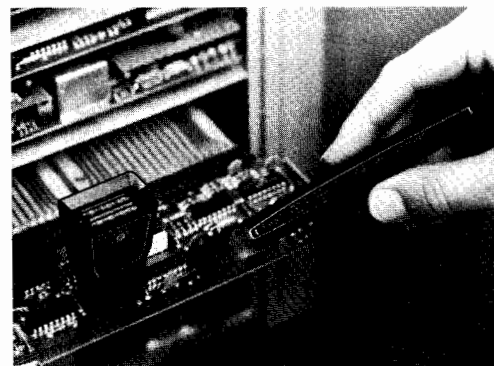

548A/546A

- In-circuit analysis
- Dynamic and static testing
- Multi-pin testing

Used individually, each of HP's IC Troubleshooters provide their own unique and important troubleshooting function. Together they become invaluable stimulus-response testing partners that help pinpoint faults and ensure fast non-destructive repair of digital circuits.

To help you take advantage of the usefulness of the IC Troubleshooters, HP has packaged them into kits which offer both ordering convenience, and cost savings. Also, applications information is available, such as AN 163-2, "New Techniques of Digital Troubleshooting", to help users derive maximum benefit from these instruments.

The table below shows a series of typical node and gate faults and the combination of tools used to troubleshoot the circuit. As with all sophisticated measuring instruments, operator skill and circuit knowledge are key factors once the various clues, or "bits" of information are obtained using the IC Troubleshooters.

To accomplish troubleshooting at the node and gate level, both stimulus (Pulser) and response (Probe, Tracer, Clip and Comparator) instruments are needed. Moreover, instruments with both voltage and current troubleshooting capability help isolate electrical faults where the precise physical location is hard to identify.

The 547A Current Tracer, the latest and most sophisticated of these troubleshooters, lets you "see" current flow on nodes and buses that otherwise appear stuck at one voltage level. Used with the 546A Pulser, stimulus-response testing is now also possible in the current domain.

FAULT	STIMULUS	RESPONSE	TEST METHOD
Shorted Node ¹	Pulser ²	Current Tracer	<ul style="list-style-type: none"> ● Pulse shorted node ● Follow current pulses to short
Stuck Data Bus	Pulser ²	Current Tracer	<ul style="list-style-type: none"> ● Pulse bus line(s) ● Trace current to device holding the bus in a stuck condition
Signal Line Short to Vcc or Ground	Pulser	Probe, Current Tracer	<ul style="list-style-type: none"> ● Pulse and probe test point simultaneously ● Short to Vcc or Ground cannot be overridden by pulsing ● Pulse test point, and follow current pulses to the short
Supply to Ground Short	Pulser	Current Tracer	<ul style="list-style-type: none"> ● Remove power from circuit under test ● Disconnect electrolytic bypass capacitors ● Pulse across Vcc and ground using accessory connectors provided ● Trace current to fault
Internally Open IC	Pulser ²	Probe	<ul style="list-style-type: none"> ● Pulse device input(s) ● Probe output for response
Solder Bridge	Pulser ²	Current Tracer	<ul style="list-style-type: none"> ● Pulse suspect line(s) ● Trace current pulses to the fault ● Light goes out when solder bridge passed
Sequential Logic Fault in Counter or Shift Register	Pulser	Clip	<ul style="list-style-type: none"> ● Circuit clock de-activated ● Use Pulser to enter desired number of pulses ● Place Clip on counter or shift register and verify device truth table

1. A node is an interconnection between two or more IC's.

2. Use the Pulser to provide stimulus or use normal circuit signals, whichever is most convenient.



5011T

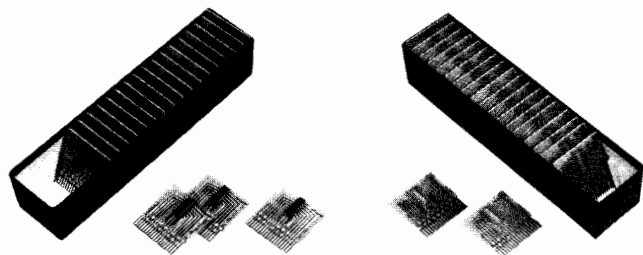

10541B

10541A

Ordering Information

5021A TTL/CMOS Troubleshooting Kit

Includes:

- 545A Logic Probe
- 546A Logic Pulser
- 548A Logic Clip

Size: 64 H x 146 W x 298 mm D (2.5" x 5.75" x 11.75").
Weight: net, 0.51 kg (1 lb 2 oz). Shipping, 0.62 kg (1 lb 6 oz).

5022A TTL/CMOS Troubleshooting Kit

Includes:

- 545A Logic Probe
- 546A Logic Pulser
- 547A Current Tracer
- 548A Logic Clip

Size: 64 H x 146 W x 298 mm D (2.5" x 5.75" x 11.75").
Weight: net, 0.65 kg (1 lb 7 oz). Shipping 0.76 kg (1 lb 11 oz).

5023A TTL/CMOS Troubleshooting Kit

Includes:

- 545A Logic Probe
- 546A Logic Pulser
- 547A Current Tracer
- 548A Logic Clip
- 10529A Logic Comparator

Size: 225 H x 200 W x 337 mm D (8.875" x 7.875" x 13.25").
Weight: net, 1.63 kg (3 lb 10 oz). Shipping, 2.19 kg (4 lb 14 oz).

5024A TTL/CMOS Troubleshooting Kit

Includes:

- 545A Logic Probe
- 546A Logic Pulser
- 547A Current Tracer

Size: 64 H x 146 W x 298 mm D (2.5" x 5.75" x 11.75").
Weight: net, 0.60 kg (1 lb 5 oz). Shipping, 0.71 kg (1 lb 9 oz).

Price
\$505

\$890

\$1450

\$700

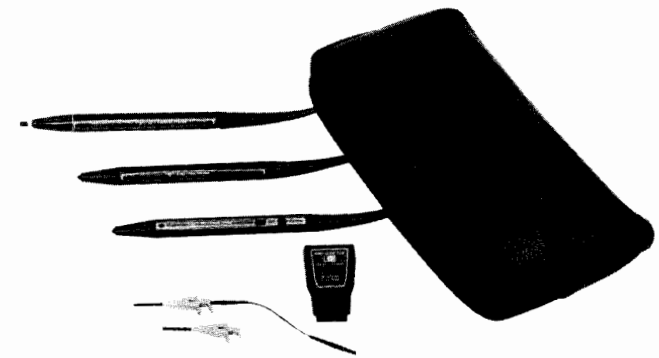

5022A

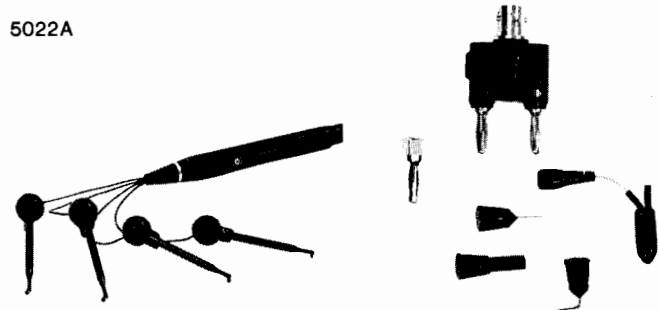

10526-60002

10525-60012

IC Troubleshooter Kits Selection Guide

	545A TTL/CMOS Probe	546A TTL/CMOS Pulser	547A TTL/CMOS Current Tracer	548A TTL/CMOS Clip	10525T TTL Probe	10526T TTL Pulser	10528A TTL Clip	10529A TTL Comparator
5011T Kit					X	X	X	X
5015T Kit					X	X	X	
5021A Kit	X	X		X				
5022A Kit	X	X	X	X				
5023A Kit	X	X	X	X				X
5024A Kit	X	X	X					

5011T TTL Troubleshooting Kit

Includes:

- 10525T Logic Probe
- 10526T Logic Pulser
- 10528A Logic Clip
- 10529A Logic Comparator

Size: 82.6 H x 203 W x 311 mm D (3.25" x 8" x 12.25").
Weight: net, 1.49 kg (3 lb 5 oz). Shipping, 2.11 kg (4 lb 11 oz).

5015T TTL Troubleshooting Kit

Includes:

- Model 10525T Logic Probe
- Model 10526T Logic Pulser
- Model 10528A Logic Clip

Size: 64 H x 133 W x 286 mm D (2.5" x 5.25" x 11.25").
Weight: net, 0.63 kg (1 lb 6 oz). Shipping, 0.74 kg (1 lb 10 oz).

Accessories Available

00545-60104: Tip Kit for 545A Probe, and 546A Pulser

10525-60012: Tip Kit for 10525T Probe, 10526T Pulser

10525-60015: Pulse Memory for 10525T Probe

10526-60002: Multi-pin Stimulus Kit for Logic Pulsers

10529-60006: External Reference Kit for 10529A Comparator

10541A: Twenty blank reference boards for 10529A Comparator

10541B: Twenty pre-programmed reference boards for 10529A Comparator

\$920

\$365

Price

\$50

\$60

\$240

\$60

\$370

\$100

\$195

DIGITAL CIRCUIT TESTERS

Signature Analyzer, A Digital Troubleshooting Tool

Model 5004A

- Full at speed testing of digital products
- Reduced skill level necessary to troubleshoot microprocessor-based products to component level
- High confidence testing (>99.998%)
- Reduce warranty and service support costs

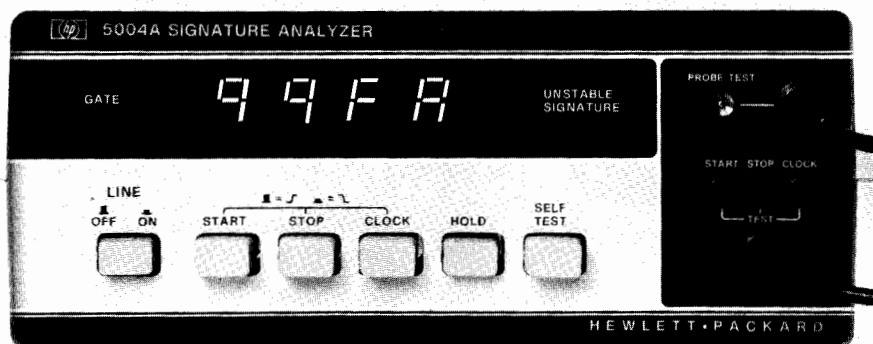

The Product

The HP5004A Signature Analyzer is a tool for production and service troubleshooting of complex logic circuits. It recognizes and displays unique digital signatures associated with data nodes in a circuit under test. By comparing these actual signatures to the correct ones, a technician can back-trace to a faulty node. In microprocessors and high speed digital state machines, where data streams are long and complex, the 5004A Signature Analyzer, unlike conventional measurement tools, allows full at-speed component-level troubleshooting.

The Technique

HP's patented Signature Analysis technique enables the 5004A to display a compressed, four-digit "fingerprint" of the data stream present at a node. This signature is generated from a linear feedback shift register in the 5004A, and is unique for a specific good node. Any fault associated with a device on that node will force a change in the data stream and, therefore, result in an erroneous signature.

Troubleshooting requires only the skill to follow a test procedure comparing measured signatures in a circuit to correct signatures noted within the product documentation. (The resulting probability of detecting an erroneous data stream is 99.998%, the probability of detecting a single-bit error in a data stream is 100%.) Signature Analysis also detects time-related faults, such as mid-cycle displaced bits, which are not detectable by traditional transition and ones counting techniques.

The Application

For a product which has been setup for Signature Analysis, troubleshooting typically consists of:

- Switching the product to be tested into a test mode of operation.
- Attaching the 5004A's START, STOP, CLOCK and GND leads to the test points of the product to be tested (no board or component removal required).
- Probing circuit nodes and observing the signatures displayed on the 5004A.
- Comparing them to correct signatures preprinted on a schematic or troubleshooting procedure for the product under test.
- Isolating a faulty node by observing an erroneous signature.
- Tracing signatures back through gates and memory elements, until an element with correct inputs and faulty outputs is isolated.
- Replacing only the faulty component.

These steps can be performed quickly on-site, at a field service facility, or on a production line.

Additional information on Signature Analysis is available in the HP Application Note Series 222.

5004A Specifications

Display: 4 digits. Characters 0-9, ACFHPU.

Fault detection accuracy: 100% probability of detecting single-bit errors; 99.998% probability of detecting multiple-bit errors.

Minimum gate length: 1 clock cycle (1 data bit) between START and STOP.

Maximum gate length: no limit.

Minimum timing between gates: 1 clock cycle between STOP and START.

Data probe tip: Acts as high-speed logic probe. Lamp indicates high, low, bad-level and pulsing states. Minimum detected pulse width is 10 ns.

Data probe timing:

Setup time: 15 ns (data to be valid at least 15 ns before selected clock edge.)

Hold time: 0 ns (data to be held until occurrence of selected clock edge.)

START, STOP timing:

Setup time: 25 ns (signals to be valid at least 25 ns before selected clock edge.)

Hold time: 0 ns (signals to be held until occurrence of selected clock edge.)

CLOCK timing:

Maximum clock frequency: 10 MHz.

Minimum pulse width: 50 ns in high or low state.

Logic thresholds:

Data input: Logic one: 2.0 V, +1-4

Logic zero: .8 V, +4-0

START, STOP, CLOCK inputs: Single threshold, 1.4 V \pm .6 (.1 V Hysteresis).

Input impedance: All inputs, 50 k Ω to 1.4 V, shunted by 7 pF.

Overload protection: All inputs: \pm 150V continuous. \pm 250 V intermittent. 250 V AC for 1 minute.

Operating environment: Temperature: 0-55°C. Humidity: 95% RH at 40°C.

Power: 25 VA max. See options below for power line voltage and frequency.

Weight: Net: 2.5 kg, 5.5 lbs. Shipping: 5 kg, 11 lbs.

Size: 90 mm high x 215 mm wide x 300 mm deep (3½ in. x 8½ in. x 12 in.), excluding handle.

Supplemental characteristics:

Front panel indicators: Flashing GATE light indicates detection of valid START, STOP, CLOCK conditions. Flashing UNSTABLE light indicates a difference between 2 successive signatures, and possible intermittent faults.

Ordering Information

5004A Signature Analyzer: \$1100.00

Option 910 Additional Manual: 11.50

Orders must specify one of these power line options

Option 100: 100 V AC line, +5%, -10%, 48-440 Hz N/C

Option 120: 120 V AC line, +5%, -10%, 48-440 Hz N/C

Option 220: 220 V AC line, +5%, -10%, 48-66 Hz N/C

Option 240: 240 V AC line, +5%, -10%, 48-66 Hz N/C



- Digital and Analog Measurement Capability Optimized for Digital Troubleshooting
- Easy to Use Single Probe Measurement of Logic Signals, Voltage, and Frequency
- 20 MHz, Multiple Logic Family Signature Analysis with Qualified Cloning Mode
- Compact and Portable

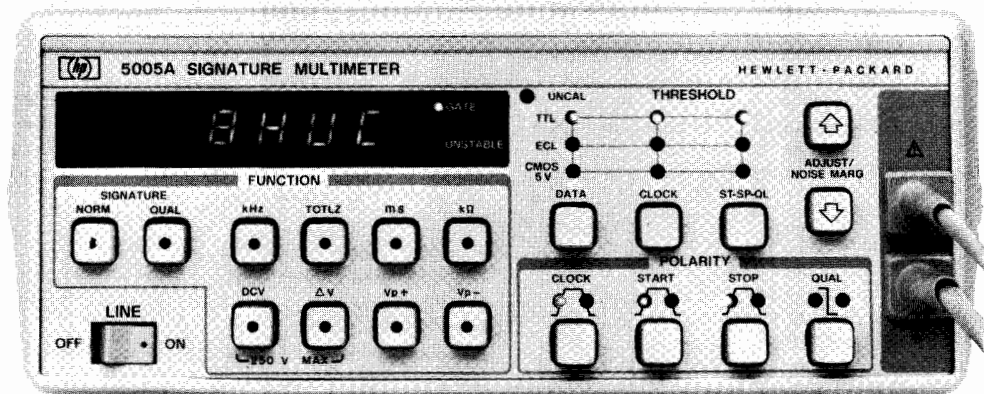

Description

In the time since its 1977 introduction, Signature Analysis has proven an essential tool for fast, reliable digital troubleshooting. However, total checkout of a digital system often requires additional instruments; a digital multimeter for checking power supplies and circuit board integrity, a universal counter to measure clock frequencies and time intervals, and an oscilloscope to verify logic levels under dynamic conditions. The HP 5005A now offers the following functions, in a compact portable instrument:

- Field proven signature analysis (for all logic families)
- Digital multimeter (DC volts, resistance and differential voltage)
- Counter (frequency, totalize, time interval)
- Voltage threshold (upper voltage peak, lower voltage peak)

Optimizing troubleshooting through incorporating several measurement functions within a single instrument occurs only if each function proves convenient to use. The HP 5005 signature multimeter offers simple single button selection of function with measurement results shown on a common display. More importantly, most measurements (i.e., signature analysis, voltage threshold, frequency, etc.) can be made, during the course of troubleshooting, through the logic probe without requiring instrument setup changes. The HP 5005A speeds system checkout by providing a function set optimized for digital troubleshooting, not just a pile of conventional instruments.

Signature Analysis

HP's patented Signature Analysis technique enables the HP 5005A to display a compressed, four digit "fingerprint" or signature of the digital data stream at a logic node. Any fault associated with a device connected through the node will force a change in the data stream and consequently produce an erroneous signature. A more in-depth discussion of Signature Analysis can be found in the HP Application Note Series 222.

Specific features of the 5005A Signature Analyzer mode include:

- Multiple logic family compatibility—preset threshold levels for TTL, CMOS, and ECL with front panel adjustability (+12.5V to -12.5V) assures coverage of a wide range of logic device types.
- 20 MHz clock frequency—extends Signature Analysis to high speed circuits, such as CRT displays.
- Qualified signature mode—speeds fault isolation in complex products by windowing signature collection to specific modules or devices without requiring major test setup changes. This simplifies the engineering involvement in hardware and software testability and accelerates test procedure preparation.

Digital Multimeter

Certain digital problems result from analog circuitry failures: a low power supply voltage, an open shorted or high resistance circuit path, a faulty A/D or D/A converter. Each may contribute to a system failure. The HP 5005A contains a 4½ digit DC voltmeter, ohmmeter, and differential voltage function each with performance geared toward analog measurements necessary in digital troubleshooting.

Checking analog signals with the HP 5005A requires simple moving the logic probe to the proper analog node, pressing the appropriate function button (DCV or kΩ), and reading the displayed value. Pressing the proper signature analyzer function button (NORM or QUAL) returns the probe to its logic measurement mode.

Voltage Threshold

Logic level degradation is a common and troublesome malfunction in digital products. Isolating this failure typically requires displaying the signal and interpreting a waveform. The 5005A provides a simple, direct method to measure logic high and logic low voltage of dynamic signals.

The peak voltage measurement mode allows the 5005A to read and display either the highest (positive peak) or lowest (negative peak) voltage measured at the probe. Selection of either positive peak or negative peak voltage mode displays the appropriate threshold for comparison against the specifications of the logic family being measured.

Differential voltage measurement (measurement of voltage differences between two points) can be made by measuring the voltage reference point, pressing the differential voltage key (ΔV), then measuring the second point. The display indicates the difference in voltage between the two probed points without requiring the burdensome task of isolating the voltmeter from ground. Voltage changes in components and power supplies are made quickly, easily and safely.

Counter

The counter within the 5005A provides totalizing and frequency measurement to 50 MHz, and time interval measurement to 100 nanosecond resolution. Intended to extend the digital troubleshooting capability of the 5005A beyond strictly synchronous measurement (signature analysis), the counter functions provide the ability to characterize one shots and timers through time interval measurement; test interrupt lines, reset lines and asynchronous communication (RS232) interfaces through totalizing and verify clock and clock divider circuitry through frequency measurement.



DIGITAL CIRCUIT TESTERS

Signature Multimeter, Combines Counter and Multimeter Function with Signature Analysis
Model 5005A (Cont.)

5005A Specifications

Signature

Display: 4 digits. Characters 0-9, ACFHPU.
Fault detection accuracy: 100% probability of detecting single-bit errors; 99.998% probability of detecting multiple-bit errors.
Minimum gate length: 1 clock cycle (1 data bit) between START and STOP.
Maximum gate length: no limit.
Minimum timing between gates: 1 clock cycle between STOP and START.

Data probe timing:

Setup time: 10 ns (data to be valid at least 10 ns before selected clock edge.)
Hold time: 0 ns (data to be held until occurrence of selected clock edge.)

START, STOP, QUAL timing:

Setup time: 20 ns (signals to be valid at least 20 ns before selected clock edge.)
Hold time: 0 ns (signals to be held until occurrence of selected clock edge.)

CLOCK timing:

Maximum clock frequency: 20 MHz.
Minimum pulse width: 15 ns in high or low state.
Quality mode: allows data clock qualification by an external signal. DATA probe input impedance ≈ 50 k Ω to the average value of "0" and "1" threshold settings (± 6 V max); 10 pF.
START, STOP, CLOCK, QUAL input impedance: ≈ 100 k Ω ; 10 pF.
Front panel indicators: Flashing GATE light indicates detection of valid START, STOP, CLOCK conditions. Flashing UNSTABLE light indicates a difference between 2 successive signatures, and possible intermittent faults.

Frequency

Display: 5 digits.
Ranges: 100 kHz, 1 MHz, 10 MHz, 50 MHz, autoranged.
Resolution: 1 LSD (1 Hz on 100 kHz range).
Accuracy: $\pm 0.01\%$ of reading ± 1 count.
Minimum pulse width: ≈ 10 ns in high or low state.
Gate time: ≈ 1 s, fixed.
Input impedance: ≈ 50 k Ω to the average value of "0" and "1" threshold settings (± 6 V max); 10 pF.

Totalizing

Display: 5 digits.
Range: 0-99,999 counts.
Resolution: 1 count.
Accuracy: ± 1 count.
Maximum input frequency: ≈ 50 MHz, with a minimum pulse width of 10 ns, and minimum pulse separation of 10 ns.
Minimum START/STOP pulse width: ≈ 20 ns.
DATA input impedance: ≈ 50 k Ω to the average value of "0" and "1" threshold settings (± 6 V max); 10 pF.
START, STOP input impedance: ≈ 100 k Ω ; 10 pF.

Time Interval

Display: 5 digits.
Ranges: 10 ms, 100 ms, 1 s, 10 s, 100 s, autoranged.
Resolution: 1 count (100 ns on 10 ms range).
Accuracy: $\pm 0.01\%$ of reading ≥ 1 count.
Minimum START/STOP pulse width: ≈ 20 ns.
DATA input impedance: ≈ 50 k Ω to the average value of "0" and "1" threshold settings (± 6 V max); 10 pF.
START, STOP input impedance: ≈ 100 k Ω ; 10 pF.

Resistance

Display: 4 or 5 digits, depending on range.
Ranges: 30 k Ω , 300 k Ω , 1 M Ω , 3 M Ω , 10 M Ω , autoranged.
Accuracy: (at 15°C-30°C).

RANGE	FULL SCALE	ACCURACY	DISPLAY RESOLUTION
30 k Ω	29,999 k Ω	$\pm 1\%$ of reading $\pm 2 \Omega$	1 Ω
300 k Ω	299.99 k Ω	$\pm 1\%$ of reading	10 Ω
1 M Ω	999.9 k Ω	$\pm 1\%$ of reading	100 Ω
3 M Ω	2999. k Ω	$\pm 10\%$ or reading	1 k Ω
10 M Ω	10000. k Ω	$\pm 10\%$ of reading	10 k Ω

Input impedance ≈ 20 k Ω to ± 2 V

DC Voltage

Display: 4 1/2 digits.
Ranges: ± 25 V, ± 250 V, autoranged; referenced to earth ground.
Accuracy: (at 15°C-30°C).

RANGE	ACCURACY	RESOLUTION
25V	$\pm 0.1\%$ of reading ± 2 mV	1 mV
250V (<100V)	$\pm 0.25\%$ of reading ± 20 mV	10 mV
250V (≥ 100 V)	$\pm 0.25\%$ of reading ± 20 mV	100 mV

Input impedance ≈ 10 M Ω .

Differential Voltage

Reading: Reads input voltage present at the probe and displays difference between it and voltage at the time Δ V key was depressed.
Specifications: Same as for DCV, above. Voltage range is determined by larger of 2 compared voltages. Accuracy is valid for 1 minute after Δ V key depression.

Peak Voltage

Display: 3 1/2 digits.
Range: 0- ± 12 V p.
Resolution: 50 mV.
Accuracy: $\pm 2\%$ of reading $\pm 5\%$ of p-p signal ± 100 mV.
Minimum peak duration: ≈ 10 ns.
Maximum time between peaks: ≈ 50 ms.
Input impedance: ≈ 100 k Ω ; 10 pF.

Signature Analyzer Logic Thresholds

Preset thresholds: (All levels ± 0.2 V).

FAMILY	DATA '1'	DATA '0'	CLOCK-ST-SP-QL
TTL	2.0V	0.8V	1.4V
ECL	-1.1V	-1.5V	-1.3V
CMOS	3.5V	1.5V	2.5V

Adjustable thresholds: each preset threshold can be adjusted.

Range: ± 12.5 V, in 50 mV steps.
Accuracy: $\pm 2\%$ of setting, $\pm .2$ V
 Logic threshold circuitry is operative during NORM, QUAL, kHz, TOTLZ and ms measurements.

General

Data probe tip: acts as high-speed logic probe in the NORM, QUAL, kHz and TOTLZ modes. Lamp indicates high, low, bad-level and pulsing states.
Minimum detected pulse width: is 10 ns.

Data probe protection:

Continuous overload:
DCV, Δ V, k Ω modes only: ± 250 V AC/DC.
All other modes: ± 150 V AC/DC, 20V rms at input frequencies > 2 MHz.
Intermittent overload: ± 250 V AC/DC, up to 1 min, for all modes.

Timing pod protection:

Continuous overload: ± 100 V AC/DC, 20V rms at input frequencies > 2 MHz.
Intermittent overload: ± 140 V AC/DC, up to 1 min.
Auxiliary power supply: Three rear-panel connectors supply 5V at 0.7A total for pulser, current tracer or microprocessor exerciser.
Operating temperature: 0°C to +55°C.

Operating humidity: 95% RH at +40°C, except as specified otherwise for DCV, Δ V and k Ω modes.

Power: Selectable 100V, 120V, 220V or 240V AC line (+5%-10%), 48-440 Hz, 35 VA maximum.

Weight: Net: 3.5 kg, 8.0 lbs. Shipping: 10 kg, 22.5 lbs.
Size: 90 mm high x 215 mm wide x 410 mm deep (3 1/2 in x 8 1/2 in x 16 in), excluding handle.

5005A Signature Multimeter
 Option 910 Additional Manual:

\$2500.00
 \$250.00



Application Notes—An aid in evaluating testability

Hewlett-Packard has compiled, from our internal experience and the experiences of our customers, a set of application notes addressing the technical and economic aspects of Signature Analysis. This literature, available at no cost, augments the extensive factory and field based support engineering staffs available to assist you in implementing testability.

AN 222

A Designer's Guide to Signature Analysis.

(HP Publication 02-5952-7465)

Describes fundamental concepts of SA and a Signature Analyzer, how to design product for testability and serviceability, general SA design guidelines for various classes of circuits, and documentation techniques.

AN 222-1

Implementing Signature Analysis for Production Testing.

(HP Publication 5952-8785)

Shows how to test ROMs and combinatorial circuits, sequential circuits, and microprocessor-based boards with SA using the HP 3060A Board Test System. Shows how to FREERUN several microprocessors. Gives examples of SA stimulus test programs for RAM and ROM as well as an example of a board test program.

AN 222-2

Application Articles on Signature Analysis.

(HP Publication 02-5952-7542)

A collection of eight technical articles on SA applications. Includes a discussion of the Signature Analyzer's accuracy of error detection. Includes an article on FREERUN fixtures for retrofitting SA.

AN 222-3

A Manager's Guide to Signature Analysis.

(HP Publication 02-5952-7592)

Shows how to calculate the cost reductions that can be expected in production test and field service by implementing SA. Suggests simplified rules of thumb for estimating the costs, savings, and feasibility of SA. Concludes with ROI calculations for a sample product.

AN 222-4

Guidelines for Signature Analysis. Understanding the Signature Measurement.

(HP Publication 02-5952-7595)

Shows how a signature is taken by a Signature Analyzer. Contains guidelines for controlling the measurement cycle, or GATE, through the START, STOP, and CLOCK inputs. Also shows how three-state nodes are treated, and more.

AN 222-10

A Signature Analysis Case Study of a Z80-Based Personal Computer.

(HP Publication 02-5952-7591)

Shows the details of retrofitting SA into a personal computer for testing of ROM, RAM and I/O in terms of hardware, software and test connections. Includes circuit exercise program flow charts and listings. Shows START, STOP and CLOCK connections and waveforms.

AN 222-11

A Signature Analysis Case Study of a 6800-Based Display Terminal.

(HP Publication 02-5952-7622)

Describes how SA was retrofit into the 6800-based Memorex 1377 Display Terminal using the HP 5001A Microprocessor Exerciser. Shows how the 5001A preprogrammed tests exercise the 6800, the address and data buses, program ROM, scratchpad RAM, display RAM, and clock and timing circuits. Includes a listing of the custom program for testing PIAs. Describes the custom program for testing display refresh circuits. Shows how the asynchronous communications interface (IBM 3270 protocol) is tested. Gives results of circuit coverage and test effectiveness.

When you consider testability, look to Hewlett-Packard for state-of-the-art products and in-depth applications support.



DIGITAL CIRCUIT TESTERS

Microprocessor Exerciser, 6800, 8085 and Z-80 Support

Model 5001A, C, and D

- External Stimulus for Signature Analysis Troubleshooting
- 51 Preprogrammed Tests
- Full I/O Wraparound Testing
- Support for the 6800, 8085 and Z-80 Microprocessors
- Unique Memory Overlay for Preprogrammed Tests

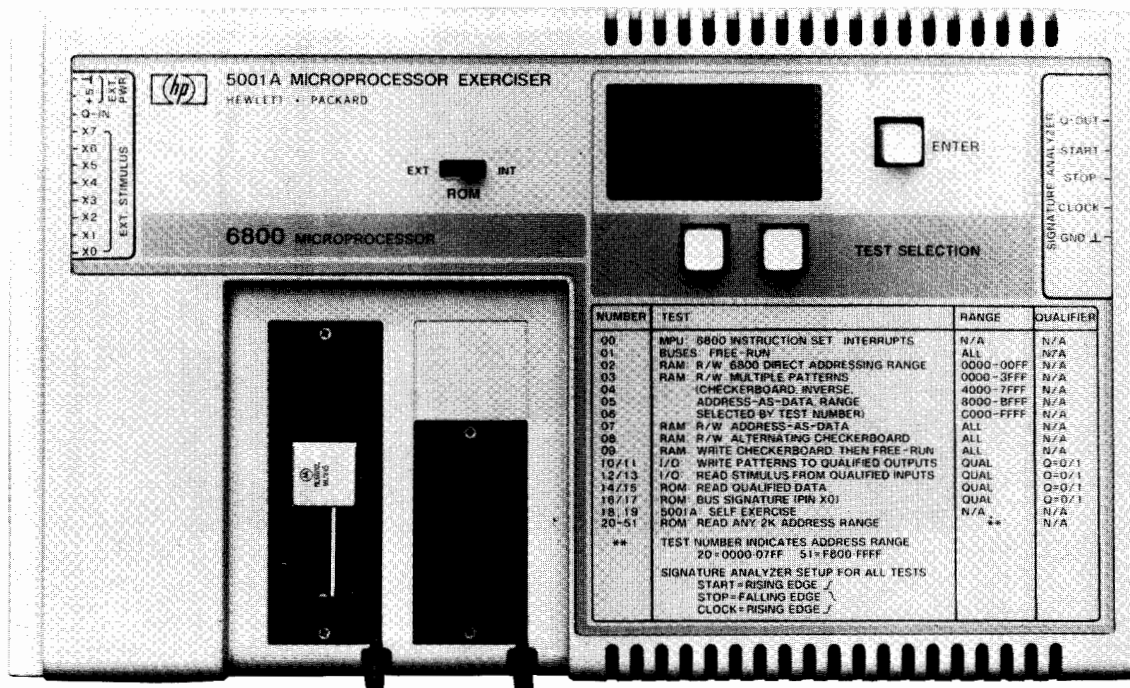

Description

The HP 5001 series of Microprocessor Exercisers offers a new alternative to add enhanced testability, in microprocessor-based products. Used in conjunction with a Signature Analyzer, the HP 5001 provides an external source of either preprogrammed or custom test stimulus to the microprocessor or input ports of a system. The operator simply removes the microprocessor from the system under test, connects the HP 5001 Microprocessor Exerciser, and utilizing the three button front panel, selects the test program to execute.

Preprogrammed Test Stimuli

Front panel switches on the 5001 allow selection of over 50 preprogrammed tests which are stored in its ROM. These test stimuli include:

- A test of the microprocessor instruction set and interrupts.
- A free-run test for address and data bus integrity.
- ROM read tests.
- RAM read-write tests.
- Output port pattern tests.
- Input port pattern tests.

The 5001 utilizes the microprocessor of the product under test to repetitively execute preprogrammed stimuli.

Custom Test Stimuli

The 5001 can be utilized to run custom programs for those portions of the product under test which require stimulus beyond that provided by the preprogrammed routines. It has a socket which allows instructions to be executed from a custom programmed ROM. The user writes stimulus programs, generates a PROM containing the appropriate microprocessor code and places it into the 5001A to execute up to 2K bytes of external stimulus. Typical custom tests could include:

- Configuration and stimulus for PIA's.
- Pattern stimuli for sequential logic outboard of output ports.
- Go/no go functional tests.

Memory Overlay

A unique memory overlay scheme makes all preprogrammed tests and custom ROM programs independent of the system under test memory map. A product may use its entire memory space without reserving ROM space for test programs. Additionally, this feature allows all programs to run independently of memory faults in the system under test.

Single Signature Tests

Certain preprogrammed stimuli are designed to provide pass/fail information on the microprocessor, RAM and ROM through a single signature. For example, to save troubleshooting time a particular RAM test requires collecting only a single signature to verify a RAM rather than collecting signatures of all RAM pins.

Qualified Stimuli

Some stimuli utilize a "qualify" line to optimize testing by dynamically modifying the effective address range of the preprogrammed test. For example, the output port tests call for the qualify line to be connected to the chip-enable pin of the port to be tested. The microprocessor searches its address field until that chip is enabled (and the qualify line asserted) then writes all possible patterns to that port, repetitively.

Bus Signatures

The 5001 can read data from the product under test, as well as write patterns into it. Certain stimuli utilize this feature to read bus data, serialize it, and output a single bit stream. This "bus signature" saves time and reduces the potential errors in probing several separate points on a bus.

Input Port Stimuli

The 5001 has eight output lines under microprocessor control. These can be used to stimulate input ports or circuitry within the product under test without requiring additional equipment, connectors, or fixtures. Reading the results into the 5001 allows full wrap-around testing of the product under test.

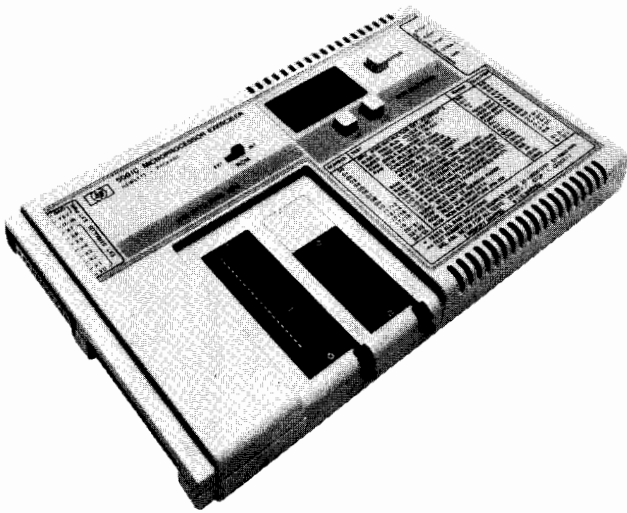

- 8085 Microprocessor Support

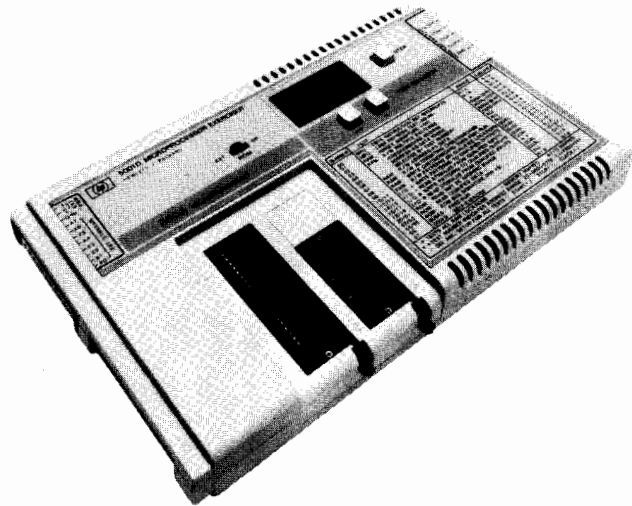

- Z-80 Microprocessor Support

SA Interface

A signature analyzer port on the 5001 allows quick and easy connection of START, STOP, CLOCK, and ground. Full control of these signals through either preprogrammed tests or through the custom test ROM saves time by reducing equipment setup changes.

5001C Specifications—(8085)

Main interface to product under test (ribbon cable).

Clock frequency with CLOCK switch set to:

Ext (External Crystal on X1, X2): 6.25 MHz max.

CLK Out: 3.125 MHz max.

INT (Internal Crystal on X1, X2): 4.00 MHz.

CLK Out: 2.00 MHz.

Minimum frequency as specified by 8085 manufacturer.

ROM specifications.

ROM Type: Intel 2716 EPROM or equivalent.

ROM specifications (for maximum clock frequency):

Maximum address to output delay (tacc):

557 nsec NOMINAL.

Maximum chip select to output delay (tco):

256 nsec NOMINAL.

5001A Specifications—(6800)

Main interface to product under test (ribbon cable).

Clock frequency with ROM switch set to:

EXT (External ROM): 2.0 MHz max.

INT (Internal programmed ROM): 1.5 MHz max.

Minimum frequency: 100 kHz.

ROM specifications.

ROM Type: Intel 2716 EPROM or equivalent.

ROM specifications (for maximum clock frequency):

Maximum address to output delay (tacc):

250 nsec NOMINAL.

Maximum chip select to output delay (tco):

190 nsec NOMINAL.

5001D Specifications—(Z-80)

Main interface to product under test (ribbon cable).

Clock frequency with ROM switch set to:

EXT (External ROM): 4 MHz max.

INT (Internal programmed ROM): 4 MHz max.

Minimum frequency as specified by Z-80 manufacturer.

ROM Specifications.

ROM Type: Intel 2716 EPROM or equivalent.

ROM specifications (for maximum clock frequency):

Maximum address to output delay (tacc):

355 nsec NOMINAL.

Maximum chip select to output delay (tco):

245 nsec NOMINAL.

General Specifications

Operating Temperature: 0–55°C.

Power Requirements: +5 V DC \pm 5%

5001A: 550 mA Nominal.

5001C: 500 mA Nominal.

5001D: 550 mA Nominal.

Excluding the microprocessor and external custom ROM.

Shipping Weight: 1.36 kg (3 lbs).

Dimensions: 235 mm long x 140 mm wide x 26 mm high
(9¼" x 5½" x 1").

Ordering Information:

5001A Microprocessor Exerciser for 6800 Systems \$900

5001C Microprocessor Exerciser for 8085 Systems \$900

5001D Microprocessor Exerciser for Z-80 Systems \$1075

Option 910: Extra Manual \$18

Accessories include: microprocessor interface ribbon cable, external stimulus port cable, external power cable, 11 test point grabbers, protective carrying case, and operating and programming manual.

DIGITAL CIRCUIT TESTERS

Digital Education Courses

Models 5035A, 5035T Logic Labs

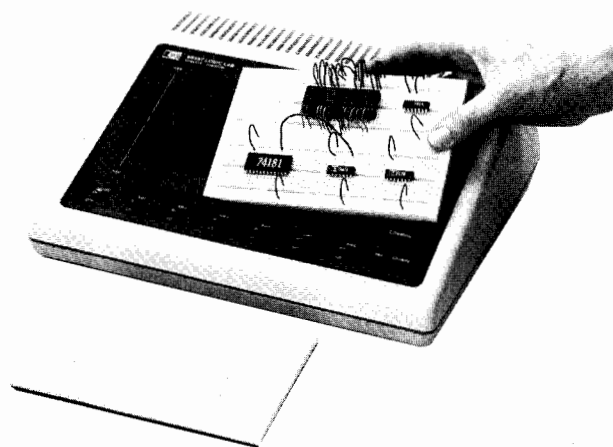

5035T Complete Logic Lab

Learn logic . . . the practical way. HP's Model 5035T Logic Lab combines theory and lab so you'll learn digital logic quickly, enjoyably, and memorably. Start by building simple circuits and work up to complete numerical readout clocks. Adopted by schools, industrial firms and individuals who want to keep up with the changing world of electronics, and enjoy doing it.

5035T Logic Lab Ordering Information

Includes

5035A Mainframe with removable breadboard (see below)
"Practical Digital Electronics"—An Introductory Course

- Complete textbook
- 26 Experiment Workbook
- TTL/DTL Test Instruments**
- 10525T Logic Probe
- 10526T Logic Pulser
- 10528A Logic Clip
- Wire and Component Kit**
- 32 TTL, MSI, LSI ICs
- 285 Pre-stripped Wires
- 4 Large LED numerical displays
- IC Remover

Accessories Available

	Price
1258-0121: Additional Breadboard Assembly	\$65
10656A: Set of 10 "Practical Digital Electronics" An Introductory Course—Texts and Lab Workbooks	\$150
10657A: Additional Component and Wire Kit	\$150
5035T Logic Lab	\$900

5035A Logic Lab Mainframe

The 5035A Logic Lab Mainframe brings convenience and flexibility to breadboarding by allowing solderless connection of new circuit ideas. Fully self-contained, the mainframe has a 5-volt 1-amp power supply, two clocks, four LED indicators, six data switches, two 5-volt BNC connectors, and a handy removable breadboard. To use it, just connect up circuits using standard 24-gauge wire, then power up either one or several breadboards to quickly and easily verify new circuit ideas before incurring expensive PC board layout and rework charges.

5035A Mainframe Ordering Information

Power supply: 5 volts \pm 5%, over 0-1 Amp range; 10 mV rms ripple maximum. Continuous short circuit protection.

Data switches: 6 bounceless slide switches for TTL high/low outputs.

LED indicators: 4 high/low indicators.

Clocks: 2 independent; 1 Hz and 100 kHz.

Breadboard assembly (HP part number 1258-0121): removable.

Interconnections: all power supply, data switch, LED indicator, and component contact points may be interconnected by standard 24-gauge hook-up wire.

Power requirements: 100/120/220/240 V ac \pm 5, \pm 10% 50 or 60 Hz line frequency; 30 watts max; 0°C–55°C.

Size: mainframe, 311 H x 89 W x 267 mm D (3 1/2" x 12 1/4" x 10 1/2"). Breadboard assembly: 165 H x 114 W x 13 mm D (6 1/2" x 4 1/2" x 1/2").

Weight: net, 5.9 kg (13 lb). Shipping, 6.9 kg (15.13 lb).

Accessories Available

	Price
1258-0121: Additional breadboard assembly	\$65
1540-0258: Heavy duty, padded vinyl carrying case	\$75
05035-60006: Wire interconnect kit (258 prestripped, assorted length and color, 24 gauge hook-up wires)	\$35

5035A Logic Lab

\$475

DIGITAL CIRCUIT TESTERS

Microprocessor Lab

Model 5036A



- Covers hardware, software and troubleshooting in one course.
- A practical, hands-on course for the general technical community.



- Textbooks are available in English, German, French and Italian editions.

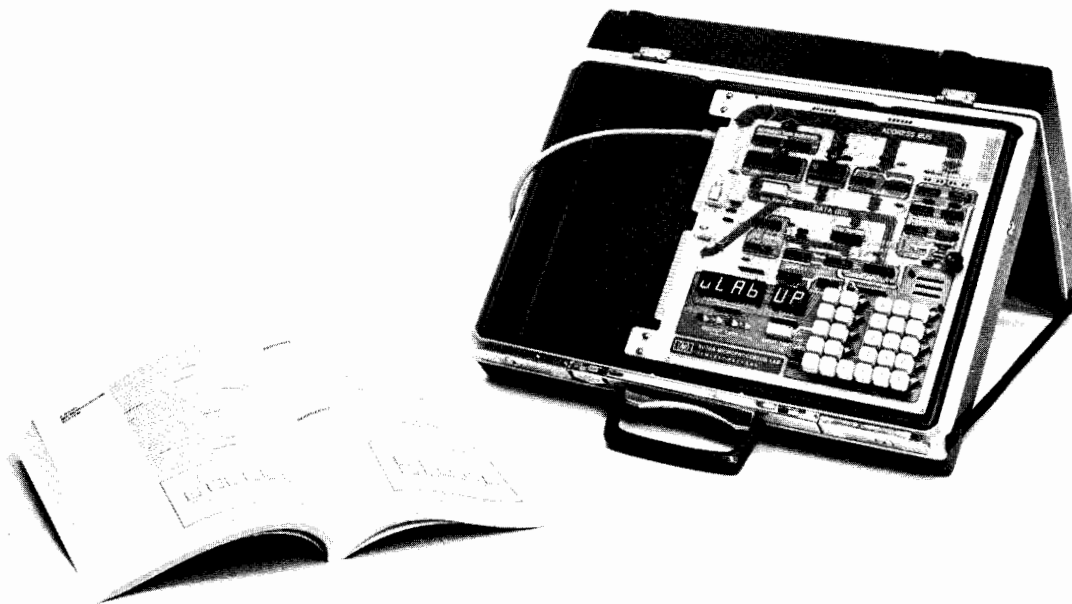

Staying Current with Technology

The microprocessor represents an extension of electronics technology into areas previously dominated by mechanical devices, older electronic or electrical means, or even hydraulics. This means more versatile, less expensive electronic tools are rapidly replacing older less efficient equipment. However, repair of microprocessor-based systems by engineers, scientists and technicians trained on older equipment is a problem area ignored until now.

The microprocessor presents a repair problem due to its complexity, and because it is used in so many diverse products. Repair of these microprocessor products is currently a challenge to manufacturers. Little imagination is required to anticipate field repair problems with great quantities of microprocessor-based products like the following:

- Traffic Controller
- Typesetter
- POS Terminal
- Tire Balancer
- Photo Finisher
- Test Instruments
- Pipeline Control System
- Medical Instrumentation
- Telephone Exchange
- Taxi Meter
- Oceanographic Telemeter
- Elevator Control System

There are great numbers of scientists and engineers who can contribute to solving this problem by learning about both the hardware and software in microprocessor systems, and there is a virtual army of technicians who need to learn to troubleshoot them. The 5036A Microprocessor Lab provides both the hardware and software basics and vital troubleshooting information needed to solve the microprocessor puzzle.

To help fully understand how to repair faulty microcomputer systems, a user should understand both software and hardware. The 5036A course book, *Practical Microprocessors*, covers both areas in detail in separate chapters containing summaries, hands-on experiments and quizzes. Once these chapters are completed, the course builds up to a series of troubleshooting experiments employing recommended accessory troubleshooting instruments that challenge the user and reinforce major microprocessor operating concepts.

In addition to microcomputer basics, the book contains information on the use of oscilloscopes, signature analyzers, logic analyzers, logic probes and many other topics.

A practical hands-on course, *Practical Microprocessors*, removes the mystery from this exciting area and helps the user become current

in a subject bound to be required knowledge in most engineering, scientific and technical disciplines for years to come. The course book supplied is in English, but German, French and Italian editions are available; please contact only the HP sales offices in those countries regarding procurement.

5036A Major Features

- Multi-colored block diagram PC board graphics illustrate system organization to enhance learning.
- Multiple-experiment troubleshooting chapter highlights IC Troubleshooters such as 545A Probe, 546A Pulser, 547A Current Tracer and 5004A Signature Analyzer.
- Plug-in jumpers create real hardware faults that allow realistic troubleshooting practice.
- Complete resident software.
 - Easy program entry and modification.
 - Program debugging aids.
 - Interesting demonstration programs.
 - Built-in signature analysis and self-test routines.
 - 1K-Byte of user program space.
- Large, easy-to-read displays.
- Dual 5-Volt power supplies, plus edge connectors for expandability.
- Software-controlled speaker.
- LED monitors on all data, address, status and output lines.

Ordering Information

5036A Microprocessor Lab and Power Supply mounted in briefcase, plus *Practical Microprocessors* text and lab book, in English (to purchase books in German, French or Italian, please contact only the HP sales offices in those countries).

Price
\$900

Recommended Accessories for Troubleshooting Experiments:

5024A Logic Troubleshooting Kit; includes 545A Probe, 546A Pulser, 547A Current Tracer and vinyl case.

\$700

5004A Signature Analyzer

\$1,100

LOGIC ANALYZERS

Real-Time Analysis of Digital Systems



Introduction

Continuing Evolution in the Data Domain

In a seemingly overnight conversion, electronics of the 70's switched primary allegiance from analog to digital design. Now there is an equally rapid adoption of processor-based designs for the majority of these digital implementations. New disciplines are appearing, which in turn require new tools. By necessity, the new tools lag behind the need, but the frequency of appearances of "the latest answer to your measurement needs" is so great that the task of "keeping up" is becoming a formidable task for electronics engineers and digital designers.

The evolutionary pressure which created the need for new answers is felt by the instrument designers as well as the users. Hewlett-Packard continues to be one of the leaders in developing new tools to meet the ever-changing needs of the electronics industry. In 1973, HP introduced a Logic State Analyzer to provide a growing population of digital designers with a window on the parallel flow of binary data. Today, HP has a family of logic analyzers and a universal logic development system which cover a wide spectrum of measurement capabilities to serve users engaged in design, production, and service of digital products.

The Electronic Bench

The many people who design, manufacture, and service HP products also use these same instruments in their day-to-day work. This situation creates a loop of constant and immediate feedback which results in innovative answers to measurement problems. Frequently, new measurement features are the end result of a designer at one work bench providing a solution for a problem of a designer at the next bench.

A basic understanding of measurements needed for logic systems is reflected in such functional analysis concepts as cross-bus analysis and glitch triggers. An awareness of how instruments are actually used led to the development of operator interfaces that meet the needs of the experts while still serving the novices. Menu-driven instrument control simplified the operation of second-generation logic analyzers in 1976.

Syntax-driven soft keys were introduced in 1979 with the logic development system, greatly simplifying both learning and use of a powerful operating system for software development. Major steps have been taken towards the "electronic bench" of the future, which will accommodate a wide variety of design, development, and troubleshooting tasks on a multistation configuration sharing a common data base with other electronic benches.

Analysis Tools for Logic Systems

Logic systems are built from two basic elements: hardware and software. If you were to design and build a logic-based unit "from the ground up", the sequence of steps you would take are likely to be those shown in figure 1. Ideally, you would complete each step in turn, but practically, you will have to return to an earlier process and retrace your steps many times. For instance, a malfunction at the point of integrating hardware and software could send you back to check the control lines or to verify that the data lines, the controlled circuits, are transmitting the state flow properly. Different analysis instruments are optimal for different phases in development of a logic system. Digital volt meters (DVMs) and oscilloscopes are useful in the initial steps of creating the hardware base, to assure that the circuits do indeed work, and within the limits you prescribe for timing and other electrical parameters.

As the system becomes more fully defined, you need analysis tools that give you a greater overview of system performance. You have verified that each separate line functions, but now you must concern yourself with many lines operating together. A logic timing analyzer is now the optimal tool, to view activity on circuits operating concurrently, asynchronously and synchronously.

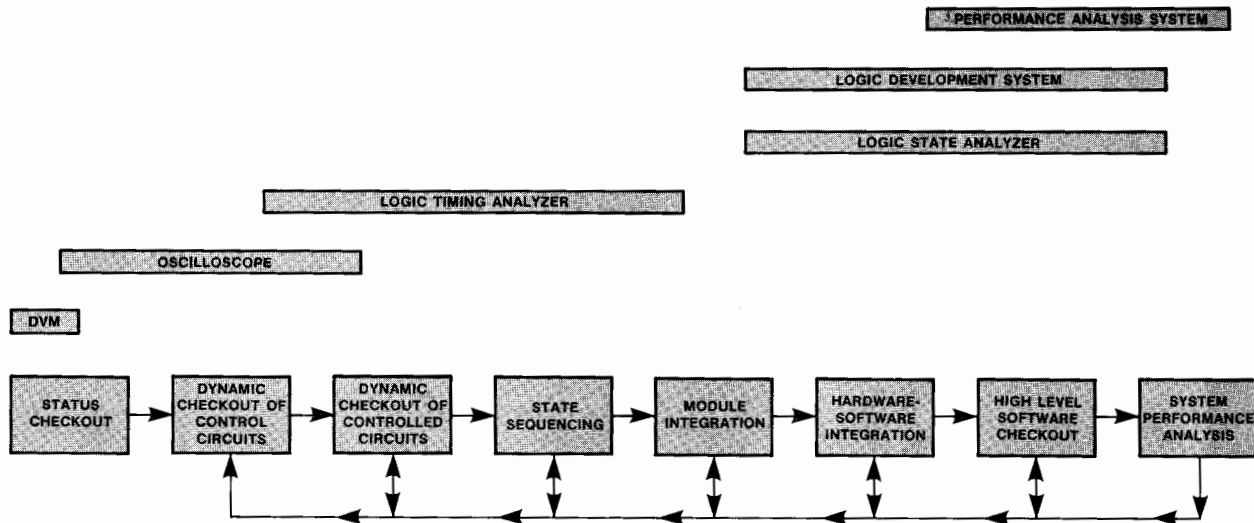

Figure 1. There are eight major functions in constructing a logic system. Different measurement instruments are appropriate for various stages, and no single instrument meets all measurement needs. Each function must be accomplished once, but, in most cases, it is necessary to return to an earlier step several times.

You now must generate code to be used with your hardware. The logic development system is the tool for software design; and, if your logic system employs a microprocessor, you can emulate your final logic system even when no hardware exists. With the initial software completed, the logic state analyzer is the optimal instrument for checking the state flow, the sequence of states on parallel, synchronous data and address lines. The logic state analyzer serves as a diagnostic tool, as any functional problem in a digital system is eventually reflected in an error in the state flow.

The job is not yet completed. Once hardware and software function adequately as a single unit, it is time to check out the high-level software performance, and to fine tune the system. Either the logic development system or a performance analysis system consisting of a logic analyzer with a Hewlett-Packard Interface Bus (HP-IB) capability, a computer or controller and a printer/plotter, enable you to make complex measurements on efficiency and effectiveness of your logic system.

As a final step, if your system is to be part of a larger logic system and the tie to that system is a serial transmission interface, such as the RS-232-C (V24) interface, then the serial data analyzer is the proper analysis instrument.

Team Approach

The one designer-one system approach to development of logic products is becoming less common. Competitive time pressures, complexity of the product, and the magnitude of the development process make it necessary to use teams of designers and developers.

Ordinarily, two teams are used, a hardware team and a software team. As shown in figure 2, logic analyzers and the logic development system have overlapping applications, but there are applications that are unique to

each of the two tools. Logic analyzers have an advantage of greater portability and a more sophisticated feature set focused on a specific measurement and analysis sphere: timing, state, or serial analysis. The logic development system becomes economically advantageous for larger scale logic system development projects, and greatly facilitates the team approach through a multistation configuration sharing a common data base.

Choosing the best analysis and development instruments for your needs is a function of your applications. Before selecting instruments, first determine what measurements and capabilities you need to accomplish your major functions. Then familiarize yourself with the measurements and capabilities available with each class of instrument. Compare the relative value of each to your applications, both today and tomorrow.

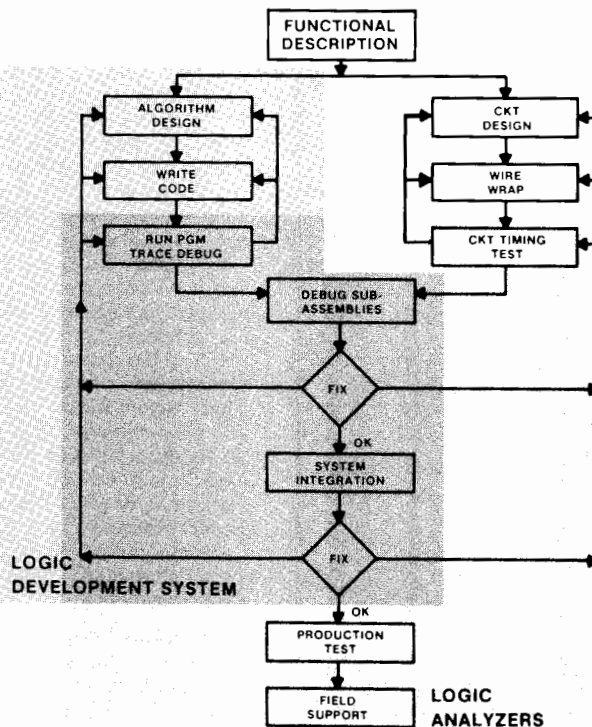

Figure 2. In the typical development cycle for digital systems, the Logic Development System is the proper tool for earlier design phases of creating and debugging software, while logic analyzers contribute sophisticated analysis capability to all phases of the development cycle beyond initial code generation and circuit building.

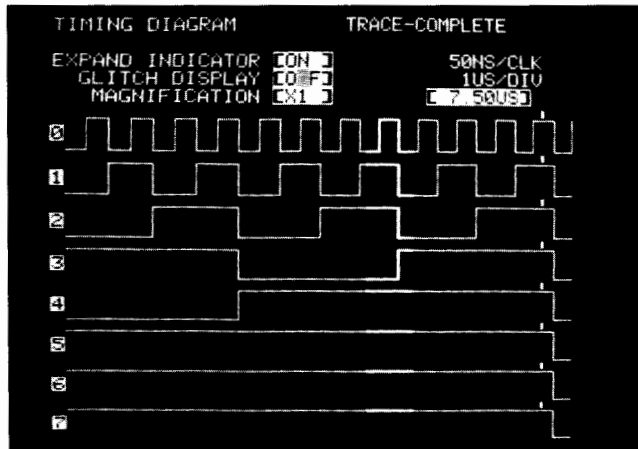

Figure 3. Timing display of a logic timing analyzer shows the state, high or low, of each of the eight lines monitored at each occurrence of an internal clock. Reference point for data collection, the trigger event, is indicated by the small tick mark.

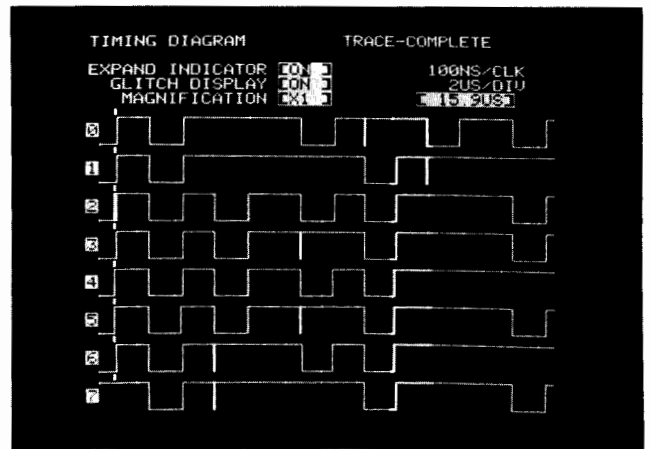

Figure 4. This timing analyzer display shows glitches as brightened vertical bars. Triggering data collection at the occurrence of a glitch on selected control lines and a Boolean pattern is a convenient feature for many troubleshooting applications.

Timing Analysis

The logic timing analyzer is often called the hardware designer's tool. A primary function of the timing analyzer is providing a display of the functional timing relations between signals on the logic circuits.

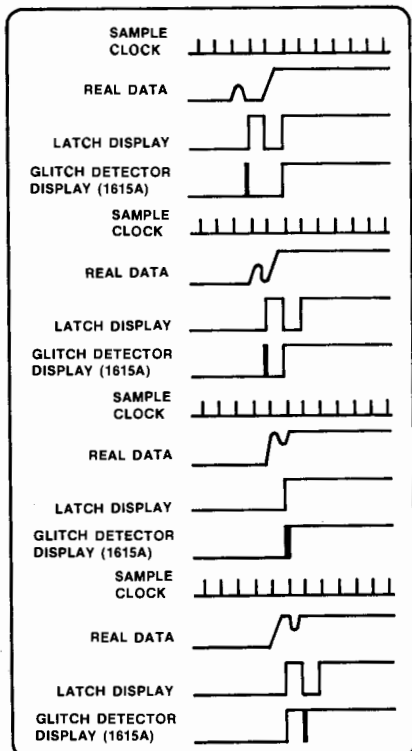

Figure 5. Two common forms of capturing glitches result in very different displays. The latch, or stretcher, circuit shows the same display whether the glitch occurs two clock periods ahead, one clock period ahead, or one clock period after the data transition. A glitch in the same clock period as the data transition is not registered by the latch circuit.

Timing analyzers do not replace DVMs and oscilloscopes; they provide a different measure. DVMs are used early in the design cycle (see figure 1) to check continuity and voltage levels, to assure that there will be no catastrophic failure when the system is turned on initially. Oscilloscopes are then used to check static and dynamic conditions of the control lines; e.g., is the reset in the correct state? Is the clock phasing proper? Once the initial design restraints are met, the hardware designer turns to the logic timing analyzer to check the control lines that are active, and subsequently, the controlled lines—the data and address lines.

Uniqueness of the measurement set of a logic timing analyzer is due to several features. A timing analyzer can trace the activity on multiple channels simultaneously. Unlike the logic state analyzer, the timing analyzer can collect information asynchronously as well as synchronously. A time filter distinguishes valid data from random activity. Unlike the oscilloscope, the timing analyzer can collect data in negative time; i.e., the analyzer will display the timing traces of line activity that occurred prior to the selected reference point, the trigger. Time interval measurements can be made, and data collection can be delayed beyond the trigger point by time or event counts. Perhaps the most valued feature to the hardware designer is the glitch detection circuit of the Hewlett-Packard Logic Analyzer, which captures a glitch, stores it separately, and displays it uniquely. Glitches can be used in trigger conditions.

Functional Timing Measurements

Displays of timing information are in the idealized form which describes two states, high or low (figure 3). The search for glitches, inappropriate timing intervals, and signals occurring in the wrong sequence is a large part of the hardware engineer's work, in design, production, or maintenance.

Triggers are the reference points from which data is collected, either as an end point

or an initial point. Using a time filter, which uses the same identifying time interval as the system being observed, makes the trigger truly asynchronous. The timing analyzer will not trigger on events that are transient and would not cause a response in the target system, nor will the analyzer miss any set of signals that would be accepted as valid.

Glitch Detection

Two forms of glitch detection are common. The latch method captures glitches and displays each glitch as a data bit, one sample-period wide. Glitch detection for Hewlett-Packard logic analyzers defines a glitch as more than one transition across the voltage threshold within a single clock period. Glitches are stored in a separate memory, and displayed uniquely on the timing diagram (figure 4).

The disadvantages of the glitch-latch approach can be seen in figure 5. Using a latch method to capture glitches results in the same display whether the glitch occurred two sample periods or one sample period before the data transition, or one sample period following the data transition. Glitches that occur in the same sample period as a data transition are not detected at all with the latch method; unfortunately, these can be some of the most troublesome of all glitches.

The Hewlett-Packard glitch-detection method uses twin, overlapping continuous monitors to identify glitches, and stores this information in a separate memory. Glitches on specified control lines can be used as part of trigger conditions, separately, or logically ANDed with synchronous or asynchronous triggers.

Simultaneous State and Timing Analysis

Module integration and verification of the hardware/software interface are tasks usually best accomplished through state analysis. The hardware is operational and the sequence of states are defined, and errors or problems with either hardware or software will show up as disruptions in the state flow.

However, this is the phase at which the designer frequently finds it necessary to return to earlier work to find one more overlooked glitch or alter a timing relation that was reasonable when it was built into the hardware, but simply doesn't execute well with the software. A convenient tool at this time is a logic analyzer which will monitor state flow and timing conditions simultaneously. For example, a sequence of events on asynchronous logic circuits can be investigated at a particular point in program execution. By triggering on a glitch and collecting state flow in negative time, an analysis can be made of system performance preceding the glitch.

State Analysis

Logic state analyzers capture and display the flow of events occurring synchronously in a logic system. They present a real-time window on the operating system by transparently monitoring activity on address, data, and control buses. State flow is clocked (strobed) into the analyzer with the clock signal(s) that indicate data on the lines are valid. To collect accurate information, the logic state analyzer must meet the same criteria for selecting valid signals as the logic system observed. Set-up times for the analyzer must be minimal and a zero hold time is essential to avoid interpreting transitional states as valid states (figure 6).

The operator's view of system activity is the state list shown on the analyzer's display. Display formats vary. Simpler logic state analyzers offer 16 lines, sufficient to monitor only addresses, without the accompanying data. More sophisticated analyzers offer 24 to 36 parallel inputs (figure 7), which accommodate state flow from 16-bit microprocessors or additional control-line information. Format for the display also varies. The simplest logic state analyzer lists 1's and 0's grouped in three- or four-bit sets. Second-generation analyzers, which are themselves microprocessor-driven, offer more complex displays. Inputs can be selectively grouped under labels (e.g., A for address, D for data,

E for control lines) and translated to convenient numerical bases: binary, decimal, octal, hexadecimal. Analyzers dedicated to use with specific microprocessors can reassemble the machine language to the mnemonics used by programmers (figure 8), a convenience for comparing what did happen to what should have happened. Another specialized analyzer, the serial data analyzer, monitors serially transmitted data, translates the data into the code in use, and displays both transmitted and received data.

Logic state analyzers are an example of a "next-bench" solution. Less than a decade ago, the engineers working with electronic instruments found themselves increasingly involved in the data domain, and software designers began to appear. The oscilloscope, an analog tool, did not meet the needs of designers and troubleshooters who needed to see a number of timing lines simultaneously. In fact, it soon became apparent that even the timing lines were an inefficient form of information when the pertinent data was the state of each line at each successive clock signal. Consequently, the first logic state analyzers, and all subsequent logic analyzers, are optimized for the functions of troubleshooting logic systems. Triggering and selective tracing are key features for effective analysis of state flow.

Triggering and Selective Tracing

In most logic systems, many algorithmic tasks are performed repetitively, and much of the system actively is devoted to scanning routines. Collecting all of the state flow would be cumbersome and impractical, and would bury those key areas relating to a suspected problem under a mass of detail. Logic state analyzers allow the user to pinpoint the area to be observed with methods to define a starting point for data collection (triggers) and to select (qualify) the particular kind of data to be strobed into the analyzer memory.

The simplest trigger is a single state which is set to define the initial or final point of data collection. On more complex analyzers, two

or more points can be specified to occur in sequence before "making a trace" (data collection). If a count of trigger events is available, each sequence term can be specified to occur a given number of times. In systems with frequent use of nested loops, a convenient trigger feature is a sequence restart term. If the prescribed sequence is not found by the time the sequence restart term appears, the search for the entire sequence is begun again from the first term, avoiding a situation in which sequence terms are found in different passes through a loop. One analyzer permits a trace to be taken of states within a stated range of addresses. The serial data analyzer offers triggers suitable for serial transmission: pattern, protocol, parity, or time intervals. All logic state analyzers permit data collection in "negative time", i.e., before the trigger event; and permit a delay beyond the trigger point to allow a trace far removed from a convenient "landmark." Logic state analyzers also have an output signal which will trigger other instruments, such as an oscilloscope.

Triggers determine where to collect data; qualification determines what data is collected (figure 9). The result of qualification is a

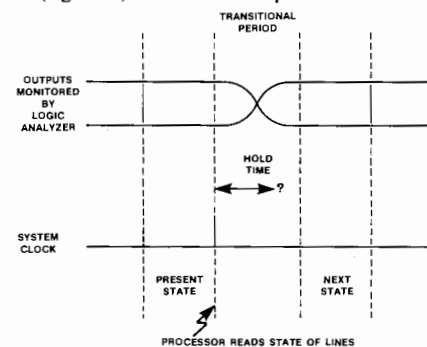

Figure 6. Data captured by a logic state analyzer may be ambiguous if the hold time is greater than zero. With a positive hold time, the analyzer may read the state of the lines in a transitional period.

```

-----TRACE LIST-----TRACE-COMPLETE-----
 LABEL      A      B      C      D      E      F      TIME
 BASE      OCT  BIN  BIN  BIN  BIN  BIN  DEC
SEQUENCE  050000  0  0  00  00  1
SEQUENCE  060000  1  0  00  00  1
SEQUENCE  050000  1  1  00  00  17  8  US
START     050000  0  0  00  00  6  540  MS
+01       050030  0  0  00  00  1  1  US
+02       060030  0  0  00  00  1  1  US
+03       060030  1  0  00  00  1  1  US
+04       050030  1  0  00  00  1  1  US
+05       050030  1  0  00  00  1  1  US
+06       050030  1  0  00  00  1  1  US
+07       050030  1  0  00  00  1  1  US
+08       050030  1  0  00  00  1  1  US
+09       050030  1  0  00  00  1  1  US
+10       060030  1  0  00  00  1  1  US
+11       050030  1  0  00  00  1  1  US
+12       050030  1  0  00  00  1  1  US
+13       050030  1  0  00  00  1  1  US
+14       050030  1  0  00  00  1  1  US
+15       050030  1  0  00  00  1  1  US
+16       060030  1  0  00  00  1  1  US

```

Figure 7. A state list as displayed on a logic state analyzer is the sequence of events occurring at the clock signals of the system under test. Modern logic analyzers allow grouping 24-36 inputs under labels, with appropriate numerical bases for each group.

```

ADDRESS DATA EXTERNAL
TRIGGER 02A0

TRIGR OCCUR=10 PRE-TRIGR=5
-----LINE 0-----
ADRS  OPCODE/DATA  EXTERNAL
029D  MOV  A, M      0000 0000
02CD  78  READ       0000 0000
029E  NOP           0000 0000
029F  STAX B        0000 0000
0BF0  70  WRITE     0000 0000
02A0  NOP           0000 0000
02A1  POP  D        0000 0000
0BBC  F3  READ     0000 0000
0BB0  0B  READ     0000 0000
02A2  INR  E        0000 0000
02A3  INR  C        0000 0000
02A4  JNZ  028E      0000 0000
028E  LXI  H, 02C0  0000 0000
0291  LDAX D        0000 0000
0BF4  10  READ     0000 0000
0292  NOP           0000 0000

```

Figure 8. Logic state analyzers dedicated to specific microprocessors can reassemble machine language into the programming mnemonics for easier comparison of the program as written to the program in execution on the user's system.

LOGIC ANALYZERS

Real-Time Analysis for Digital Systems

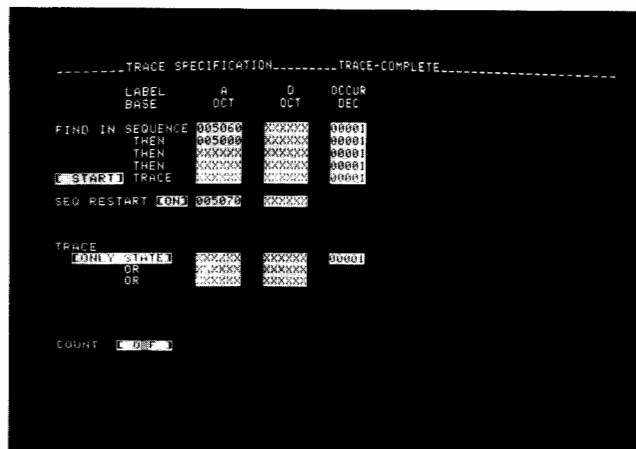

Figure 9. A Trace Specification menu for a modern logic state analyzer allows a user to set very complex conditions for initiating a state list trace and selecting specific classes of events for inclusion in the state list.

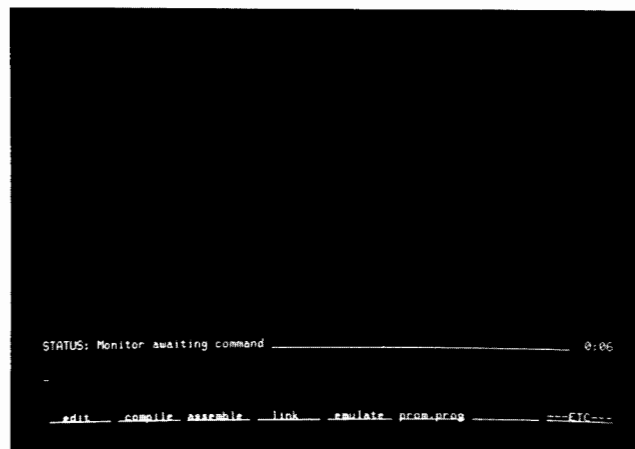

Figure 10. The eight syntax keys of the Logic Development Station are directly below the display, and the function of each key is shown on the display immediately above the key. These "soft" keys are syntax-driven. The choices shown are those on-screen at power up.

selective trace, a trace which contains only specified categories of states. There are four general ways to achieve the end of an "edited" trace: (1) tracing only trigger events; (2) tracing events independent of trigger events; (3) using clock qualifiers to collect data on the buses only when a combination of signals indicates the buses are carrying the target data type; or (4) using a dedicated or general purpose interface which is programmed to select data types. Triggering and qualification greatly reduce the amount of memory space required, and, more importantly, they save analysis time by eliminating extraneous information.

Performance Measures and Displays

Simple measures, such as counting elapsed time or number of events between two critical points in program execution, are excellent diagnostic techniques for evaluating system performance. One or both measures are available on the second-generation logic analyzers, for use in fine-tuning and optimizing a logic system.

For a quick overview, a map or a graph describe system activity pictorially. A map plots the most significant half of each word against the least significant half, and operators learn quickly to distinguish atypical system behavior patterns. The graph plots word magnitude against sequence, and it offers the additional convenience of presenting a more global view by sampling every *n*th state rather than all states in the system operation.

Connection to Target System

Connecting the logic analyzer to the system under test may be done directly with small pincer-type probes which come from each multinodal probe assembly. For repeated measurements, circuit-mounted ribbon cables simplify the connection. A general

purpose probe interface is available for easier connections and preprocessing of data flow on a wire-wrap board in the interface pod.

For some of the popular minicomputers, dedicated interfaces are available which further simplify connections, as well as providing access to the minicomputer buses. Each interface also provides further preprocessing and qualifiers.

Serial Data Analysis

The serial data analyzer is a special type of logic state analyzer. While the information is passed one bit at a time, typically across an RS-232-C (V24) interface, many inputs are required for the control signals. The serial data analyzer is a transparent monitor in synchronous or asynchronous networks and decodes data in common character sets used with link-level protocols. As an aid to locating faulty network components, this analyzer can also simulate a CPU, a terminal, or a modem. Refer to pages 608-611.

Logic Development System

Hewlett-Packard Model 64000 Logic Development System is a universal system for designing and developing microprocessor-based logic systems. A multistation system which shares a common data base on hard disc, the 64000 meets the needs of today's design teams without compromising its adequacy for tomorrow's innovations. Software engineers compose, edit, assemble, and link their routines, and may use the optional Pascal compilers and logic analysis units for effective programming and debugging. Syntax-driven soft keys make the system easy to learn and use (figure 10). Simultaneously, for selected popular microprocessors, hardware engineers can use one of the emulator options to exercise their modules even when only part of the software and hardware exist.

Minicomputer Performance

The host operating system has the processing power of a minicomputer. Each 64000 cluster has up to six development stations used with a single hard disc and printer. A 16-bit HP host processor with an independent 64k memory resides in each development station. Development stations may be configured to serve the purposes of the existing design program with a variety of options today, and reconfigured or upgraded tomorrow to match a new program in logic development. Options presently available include emulators for common microprocessors, logic analysis, PROM programmers, linkers and assemblers, and Pascal compilers. An emulation subsystem is available to add the 64000 emulation capabilities to in-house development systems already established on large, mainframe computers.

Architecture of the Logic Development System reflects Hewlett-Packard's commitment to the concept of the "electronic bench." An open-ended design, the Logic Development System architecture provides a solid base for future compatible innovations.

HP-IB Expanded Measurements

The sophisticated feature sets of stand-alone logic analyzers can be enhanced with an optional HP-IB Interface to provide automated operation, hard-copy records, or a performance analysis system. Refer to pages 22 to 27 for a complete list of HP-IB compatible instruments produced by Hewlett-Packard.

Combined with a printer or plotter/printer, permanent documentation and records can be made of logic analyzer traces, timing diagrams, and setups. Detailed analysis work can be done off-line in production



and long-term evaluations. Field personnel can take the logic analyzer to remote sites and send hard copy back to a central facility for detailed statistical studies and trend analyses.

Adding a controller to a logic analyzer through the HP-IB creates a powerful test system for many settings. In production, operator prompts and automatic setups for analysis reduce training costs while assuring uniform test procedures. Repetitive tests, complicated measurement routines, and continuous system monitoring can be accomplished with little operator involvement. Preventative maintenance can be improved by using the automated logic analyzer to flag borderline system performance, before the entire system comes down. In the laboratory, the "intelligent" logic analyzer is an excellent instrument for performance analysis.

Performance Analysis

The logic analyzer, controller, printer/plotter combination possible with HP-IB is an economical, effective system for a performance evaluation of a logic system. Data acquired by the logic analyzer can be processed by the controller to produce histograms, software execution profiles, matrices of branching probabilities, and other user-designed statistical tests and displays (figure 11). Performance analysis with the "intelligent" logic analyzer is valuable for optimizing software and dynamic monitoring to fine-tune logic systems.

Focus on Quality

Hewlett-Packard takes the time and effort required to build in the extras that often make the difference in finding efficient solutions to logic design and development problems. The care and concern in building quality instruments is, in part, due to a com-

pany-wide charter to serve customers well, but it also follows naturally because HP people build instruments they themselves use by choice, in design, development, production, and service.

Dependable Performance

Because HP engineers use the instruments they design and build, you are assured that the HP instrument you use has the dependability and careful design you need, too.

Consider the zero hold time feature of the logic state analyzers. This one feature requires additional design effort and accommodation, but it is included because HP engineers recognized the importance of obtaining a reliable signal from the system under test every time, not just "most of the time" or "with most systems." Since you use a logic analyzer with a variety of digital systems with varying specifications, the zero hold time feature completely eliminates a potential problem of acquiring transitional states which have the appearance of valid data.

A second example of the care taken to provide effective solutions is the emulator function of the Logic Development System. The designers chose to optimize "functional transparency" by constructing an emulator that makes a minimum intrusion into the target system. This decision was implemented by separating the host memory and buses from the emulator memory and buses. When you run your system with the emulator, you don't have to use processor memory space for emulation activity, and no interrupts are needed for the operating system activity. This results in fewer surprises when you replace the emulator with your processor.

Reliability and Service

All Hewlett-Packard logic analyzers and logic development systems are thoroughly

tested before shipment. Performance verification is imbedded in each instrument so you can check to make sure your instrument is performing properly each time you use it (figure 12). Because serviceability is part of an HP instrument from the very first design concepts, downtime for servicing is held to a minimum.

Friendly Interface

An instrument that is easy to use reduces training time and allows the user to focus on the design task rather than the intricacies of the design-aid tool. Logic analyzers were made simpler to operate by using an interactive menu for entering test parameters and setting up measurements. The Logic Development System introduced a new human interface concept: guided syntax and "soft" keys. Eight keys for operating the varied and complex functions of the 64000 are on the development station directly below the display. The function for each key is software-driven, and the function in current use is named on the display above the key. As a function is changed, the key functions change and new labels are shown on the display. Operators are able to begin using the Logic Development System immediately, not after extended study and repeated reference to a manual.

Summary

Your first step in selecting measurement tools is a thorough understanding of your measurement applications and environments. There is a large variety of products available, but if you know what features and measures best suit your needs, the choice is narrowed quickly. Then, apply the other rules and considerations you use in making a wise purchase.

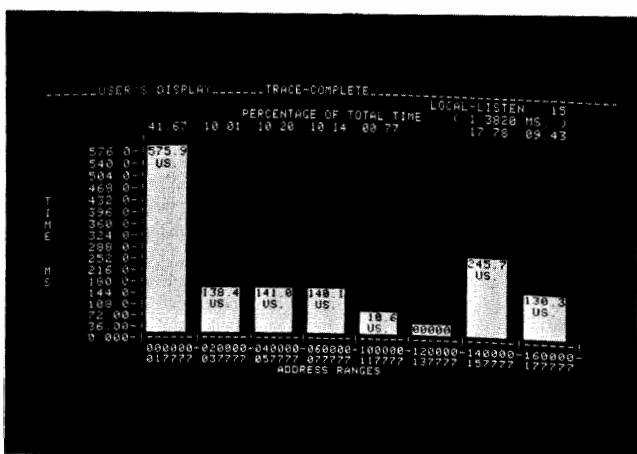

Figure 11. A logic analysis system composed of a logic analyzer, controller, and printer/plotter on HP-IB can be programmed for performance analysis. Histograms such as this are useful in evaluating program efficiency.

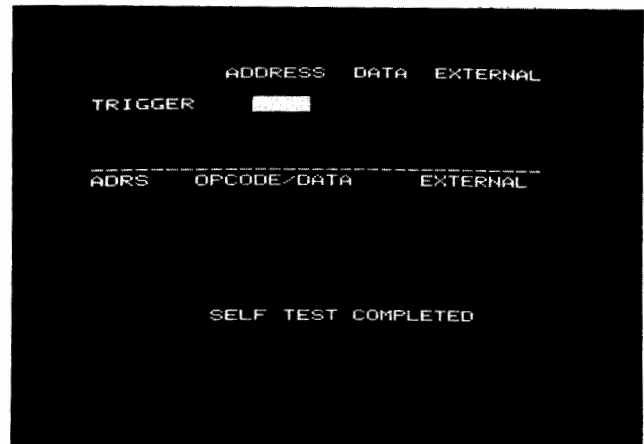

Figure 12. One form of performance verification is built into each analyzer, the self-test. At power-on, or with a rear-panel pushbutton, a series of self tests are performed by the logic analyzer to verify that the analyzer is operating correctly.

LOGIC ANALYZERS

Logic Development System

Model 64000



Model 64000 Logic Development System

Introduction

The introduction of the microprocessor has created a revolution in the design lab. Hewlett-Packard Model 64000 Logic Development System meets the needs growing out of a new design philosophy. As the cost and complexity of developing microprocessor-based products spiral upwards, there are corresponding increases in cost and complexity of the design tools. Software development is a significant, and often a major, factor in producing new processor products. Good design tools increase the efficiency and effectiveness of designers, with a consequence of a real economic benefit through decreased development time. As well as making more efficient use of the designer's time and skill, the 64000 Logic Development System gets the product to market earlier, resulting in increased revenues from the added mature sales period. For a comprehensive discussion of cost benefits and worth analyses related to development systems, refer to "Economics of Capital Equipment and Logic Development Systems," HP publication 5953-2737D, available from any HP Field Engineer.

Model 64000 Logic Development System is a multistation, hard-disc based system which combines the hardware and software design aids necessary for developing microprocessor-based products. The operating system uses an HP-proprietary 16-bit microprocessor for minicomputer-like power. Emulators are available for the most commonly used microprocessors. An open-ended architecture provides maximal flexibility for configuration today and for future expansion. Directed syntax and softkeys give the 64000 a "friendly" system, easy to learn and comfortable to use.

Two basic configurations of the 64000 System are Model 64001S Logic Development System and Model 64005S Emulation Terminal System. The emulation system, HP 64005S, in combination with an existing development system on a mainframe computer, supports emulation for 6800/6802, 8080/8085, and Z80 microprocessors. Users with an in-house software development system can retain the familiar processes and add the HP 64000 emulation function to create an even more powerful set of design tools. The Development Station

performs as a stand-alone emulation station and as an extra ASCII terminal.

A 64000LS System consists of a Model 64100A Development Station with a Model 64940A tape cartridge drive installed and a compatible disc and printer. Expansion from this configuration can be made in several dimensions. Hard-disc memory can be altered by using a different compatible disc, with 12M, 20M, 50M or 120M byte capacities. One of two printers may be used, with speeds of 180 cps or 400 lpm. Development stations can be added, to a maximum of six development stations sharing a disc and printer. Each development station may have a tape cartridge drive and a full complement of optional functions: emulation, emulation memory, logic analysis, and PROM programming.

The system bus connecting up to six development stations, disc, and printer has a maximum interconnection distance of 20 metres. Using a Model 37203A Extender, this distance can be as long as 250 metres. An RS-232-C (V24) or current loop interface in each development station provides asynchronous serial communication to serial-transmission devices, such as a teletype for tape and punch operations. These serial interfaces are convenient means for downloading software from another system, transmitting ROM masters, and creating or reading a paper tape.

It is the unique combination of features and architecture that sets the Model 64000 apart. The Logic Development Station combines all of the components needed to support a product design from definition to production.

- Supports wide range of microprocessors
- Real-time emulation and analysis
- Exceptionally friendly user interface
- Integral universal PROM programmer
- Tape cartridge for file transfer and backup
- Multiuser
- Wide range of disc and printer options

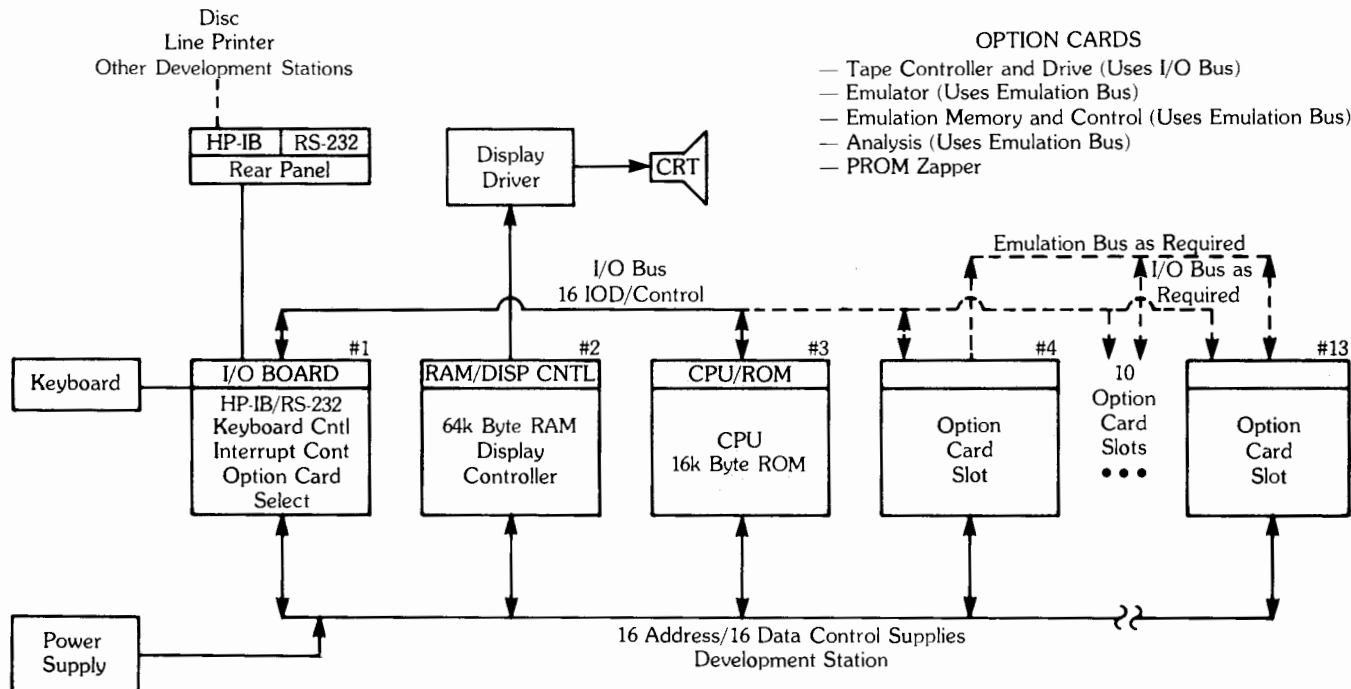

Figure 1. Model 64100A Development Station card cage reserves the first three slots for the host system, and the remaining ten slots are available for system options. If an emulation function is added, a separate, high-speed bus is used for the emulator.

System Overview

Designing with microprocessors, especially for those systems using ROM, is best accomplished if the development team has available three key capabilities: software development tools, target system emulation, and logic analysis. Due to the favorable economics and competitive pressures, many new companies are entering into processor-based design. More software specialists are graduating from colleges today, but for many designers, software design represents a new discipline. These factors, together with inherent complexities of processor-based design, have sent the cost of software development per line of code to new highs every year. Common sense dictates that these design teams have available the tools and performance aids that allow them to apply their efforts and skills effectively and efficiently. Model 64000 Logic Development System provides the tools these teams need for software development, emulation, and logic analysis.

Development Station

Model 64100A Development Station is the fundamental element of the Logic Development System (figure 1). It provides the interface between the user and the powerful operating system. Each development station contains:

- Host processor with 16k bytes of ROM, 64k bytes of RAM, and control for display and I/O
- Modular power supply
- Console with integral 12" CRT
- Full ASCII keyboard and cursor control field
- Eight softkeys that are labeled by the software
- Optional tape cartridge drive
- Card cage with ten slots available for option cards
- Optional PROM programmer
- RS-232-C (V24) interface

The development station is easy to use. The interactive display with softkeys and directed syntax lead the user through complex and powerful procedures without the need for memorizing long lists of commands and syntax or making frequent references to a manual. At each decision point, the softkey labels list all the choices available for the next step in creating a command structure. A flashing cursor identifies data entry or editing position, and it is moved with the cursor keys to change entry or control areas.

Each development station can be fully configured, or more generally, selected development stations in a cluster are optimized for specific design tasks. For example, a software designer may choose a basic station with an emulator function while a hardware designer is more likely to add logic analysis and PROM programming functions.

Hard-Disc Drives

Hard discs give the 64000 System depth and speed. The depth allows a complex, powerful operating system while still keeping an abundance of memory space free for work space. The speed makes possible a smooth coordination of all active development stations in the cluster. Together with the host processor and host memory, the fast mass storage of a hard disc facilitates good design discipline. A common, and troublesome, programming error occurs when a troubleshooter patches or fixes software in the object code, but fails to alter the source code to reflect the revision. But the 64000 System permits any keyboard command or entry to be automated directly into the command files. A change in a 2000-line program can be processed through edit, assemble, link as well as emulation, configuration and logic analysis in less than three minutes; and, the change is documented at the source code level.

Software Development

Software designers compose, revise and test code for the processor product. They need tools for language translation, source text revision, and a medium to check program execution (figure 2). Standard software for the Logic Development System includes a display-optimized editor, an "intelligent" file manager, and a linker to link relocatable code generated with optional assemblers and compilers. Command files can be created to reduce complex operations to a simple call. Test and analysis can be conducted with the addition of the emulation subsystem and the optional logic analyzer.

Relocating macroassemblers and linkers are available for each emulator subsystem. Assemblers and linkers are also available for many of the other common microprocessors, as well as an assembler which accommodates user-generated assembly programs.

Pascal/64000 is an implementation of the block-structured programming language, Pascal, for use with Model 64000 Logic Development System. There are Pascal compilers for the 8080, 8085, Z80,

```

10 FUNCTION RANDOM (VAR SEED : INTEGER) : INTEGER;
11 BEGIN
12   RANDOM := SEED;      (THE PSEUDO-RANDOM NUMBERS REPEAT)
13   SEED := (SEED * 25173 + 13849) MOD 32767; (AFTER 32767 TIMES)
14 END;                  ((IN THEORY))
15
16 PROCEDURE RANDOMIZE;  (TO INITIALIZE SEQUENCE, AND
17   (REFLECT INTO TWO BYTE INTEGER VARIABLE))
18 BEGIN
19   SEED := INTEGER(INP) * 256 + INTEGER(INP);
20 END;
21
22 PROCEDURE CLEAR;
23 BEGIN
24   FOR ROW := 0 TO RMAX DO
25     FOR COL := 0 TO CHAX DO
26       DISP (ROW, COL) := 20H;
27     END;
28 END;
29
30
31
32
33
34
35
36
37
38
39
40
41
42
43
44
45
46
47
48
49
50
51
52
53
54
55
56
57
58
59
60
61
62
63
64
65
66
67
68
69
70
71
72
73
74
75
76
77
78
79
80
81
82
83
84
85
86
87
88
89
90
91
92
93
94
95
96
97
98
99
100
101
102
103
104
105
106
107
108
109
110
111
112
113
114
115
116
117
118
119
120
121
122
123
124
125
126
127
128
129
130
131
132
133
134
135
136
137
138
139
140
141
142
143
144
145
146
147
148
149
150
151
152
153
154
155
156
157
158
159
160
161
162
163
164
165
166
167
168
169
170
171
172
173
174
175
176
177
178
179
180
181
182
183
184
185
186
187
188
189
190
191
192
193
194
195
196
197
198
199
200
201
202
203
204
205
206
207
208
209
210
211
212
213
214
215
216
217
218
219
220
221
222
223
224
225
226
227
228
229
230
231
232
233
234
235
236
237
238
239
240
241
242
243
244
245
246
247
248
249
250
251
252
253
254
255
256
257
258
259
260
261
262
263
264
265
266
267
268
269
270
271
272
273
274
275
276
277
278
279
280
281
282
283
284
285
286
287
288
289
290
291
292
293
294
295
296
297
298
299
300
301
302
303
304
305
306
307
308
309
310
311
312
313
314
315
316
317
318
319
320
321
322
323
324
325
326
327
328
329
330
331
332
333
334
335
336
337
338
339
340
341
342
343
344
345
346
347
348
349
350
351
352
353
354
355
356
357
358
359
360
361
362
363
364
365
366
367
368
369
370
371
372
373
374
375
376
377
378
379
380
381
382
383
384
385
386
387
388
389
390
391
392
393
394
395
396
397
398
399
400
401
402
403
404
405
406
407
408
409
410
411
412
413
414
415
416
417
418
419
420
421
422
423
424
425
426
427
428
429
430
431
432
433
434
435
436
437
438
439
440
441
442
443
444
445
446
447
448
449
450
451
452
453
454
455
456
457
458
459
460
461
462
463
464
465
466
467
468
469
470
471
472
473
474
475
476
477
478
479
480
481
482
483
484
485
486
487
488
489
490
491
492
493
494
495
496
497
498
499
500
501
502
503
504
505
506
507
508
509
510
511
512
513
514
515
516
517
518
519
520
521
522
523
524
525
526
527
528
529
530
531
532
533
534
535
536
537
538
539
540
541
542
543
544
545
546
547
548
549
550
551
552
553
554
555
556
557
558
559
560
561
562
563
564
565
566
567
568
569
570
571
572
573
574
575
576
577
578
579
580
581
582
583
584
585
586
587
588
589
590
591
592
593
594
595
596
597
598
599
600
601
602
603
604
605
606
607
608
609
610
611
612
613
614
615
616
617
618
619
620
621
622
623
624
625
626
627
628
629
630
631
632
633
634
635
636
637
638
639
640
641
642
643
644
645
646
647
648
649
650
651
652
653
654
655
656
657
658
659
660
661
662
663
664
665
666
667
668
669
670
671
672
673
674
675
676
677
678
679
680
681
682
683
684
685
686
687
688
689
690
691
692
693
694
695
696
697
698
699
700
701
702
703
704
705
706
707
708
709
710
711
712
713
714
715
716
717
718
719
720
721
722
723
724
725
726
727
728
729
730
731
732
733
734
735
736
737
738
739
740
741
742
743
744
745
746
747
748
749
750
751
752
753
754
755
756
757
758
759
760
761
762
763
764
765
766
767
768
769
770
771
772
773
774
775
776
777
778
779
780
781
782
783
784
785
786
787
788
789
790
791
792
793
794
795
796
797
798
799
800
801
802
803
804
805
806
807
808
809
810
811
812
813
814
815
816
817
818
819
820
821
822
823
824
825
826
827
828
829
830
831
832
833
834
835
836
837
838
839
840
841
842
843
844
845
846
847
848
849
850
851
852
853
854
855
856
857
858
859
860
861
862
863
864
865
866
867
868
869
870
871
872
873
874
875
876
877
878
879
880
881
882
883
884
885
886
887
888
889
890
891
892
893
894
895
896
897
898
899
900
901
902
903
904
905
906
907
908
909
910
911
912
913
914
915
916
917
918
919
920
921
922
923
924
925
926
927
928
929
930
931
932
933
934
935
936
937
938
939
940
941
942
943
944
945
946
947
948
949
950
951
952
953
954
955
956
957
958
959
960
961
962
963
964
965
966
967
968
969
970
971
972
973
974
975
976
977
978
979
980
981
982
983
984
985
986
987
988
989
990
991
992
993
994
995
996
997
998
999
1000

```

STATUS: Editing HALTED: DEMO2 11:44

Control Delete Find Replace (LINE #) End --[F1]---

Figure 2. The 64000 Logic Development System has a powerful editor function for ease in preparing software for processor-based products. Labels for the eight "soft" syntax keys are shown at the bottom of the display.

6800, 6802, 6809, 68000, Z8001, Z8002, 8086, and 8088 microprocessors. Other Pascal compilers are in preparation; an HP Field Engineer or Logic Development System Specialist will have a current list of available compilers.

Emulation

Emulation is an effective means to check how the software modules work with the target microprocessor and hardware. The emulation environment is valuable for debugging hardware and software at interim states. It provides download function, a RAM environment, and run controls with easy set-up.

Emulation in the Logic Development System is controlled by the host processor across a medium-speed bus. The target microprocessor in the emulation pod and emulation control cards, and emulation memory in the development stations card cage, use a separate, high-frequency bus (figure 3). The high-speed emulation memory uses 8k, 16k, 32k, or 64k of static RAM for 8-bit emulation, with additional options of 96k or 128k RAM for 16-bit emulation. Emulators for 8-bit microprocessors support 8080/8085, 6800/6802, Z80, 8048, and 6809 processors. For 16-bit microprocessors, emulators include 68000, Z8001/Z8002, and 8086/8088 units.

Ideally, emulation would be functionally and electrically transparent to the target system. With functional transparency, the emulator would impose no demands on the target system, such as reserved address space, interrupt inputs, or direct memory access. An emulator with electrical transparency would not alter the electrical specifications of the target system, such as drive capability, capacitance, timing, clock speeds, and thresholds. Practically, one form of transparency is achieved at the expense of the other form, and trade-offs must be made. In Model 64000, functional transparency has been given primacy. All emulators have a mode which is functionally transparent to the target system. However, placing the prototype target processor in the emulation pod introduces some electrical changes in the target system; processor drive, logic levels, and loading are altered by the buffers, and the bus cables introduce some capacitance. Some electrical transparency was sacrificed to gain a better functional transparency.

A necessary condition to achieve functional transparency is the isolation of emulation buses and memory from the operating system buses and memory. A major benefit gained by functional transparency is real-time emulation. This means the target system and microprocessor run at operational speeds without inserting wait states.

There are three possible modes of emulation. When all program memory is assigned to the target system, only the microprocessor activity is emulated. All execution may be performed from the emulation memory of the development system. A third mode combines

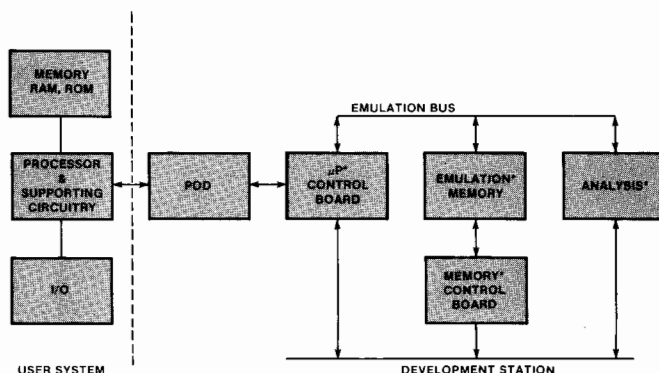

*In Development Station Option Card Slots

Figure 3. The emulation function in Model 64000 uses a separate bus for emulation control and memory, logic analysis and interface to the target system. This enhances the functional transparency of the emulator.

these two modes, and program memory is mapped to both memories, and program execution is switched between host and emulation memory as specified by the memory assignment map. Real-time operation is possible in all three modes. Fast-access memory chips are used to minimize memory board access time. Model 64000 Logic Development System allows the user to interleave host and target memories in noncontiguous 1k byte blocks.

The emulator is an important link between the development phase and the final product. As a rule, most of the program for a microprocessor-based product is stored in ROM. In the absence of any other tools, EPROMs are used during development, but even simple changes can involve a long process. Downloading to the RAM of the emulator is automatic in the 64000 system, and a great time-saver in developing software which will finally reside on the processor ROM. Address space can be allocated to emulation RAM, emulation ROM, target RAM, target ROM, and an illegal address space. Error messages are displayed any time the target processor executes an illegal operation, such as a write to ROM or a reference to an illegal address. The emulator allows mapping in 1k byte blocks for 8-bit emulators, and 1k or 4k blocks for 16-bit emulators. Any set of defined blocks can be mapped, in any order, from target address space into available emulation memory. Even if all the program is transferred to the target ROM, and one more bug is found, the suspected area can be mapped back to the emulator, revised, and checked without removing the target ROM from the circuit.

Emulators and logic analysis functions of the 64000 System can be added to existing mainframe development systems with HP 64005S Emulation Terminal System. Consisting of a Development Station, 64000 emulation hardware and software, the system can be used as a stand-alone emulator and an ASCII terminal for the host mainframe.

Programming Aids

Logic Analyzer

The optional logic analyzer transparently monitors the emulator bus for a real-time view of activity on address, data, status and control lines of the target microprocessor. Logic analysis is a valuable tool for debugging and sorting out answers to the questions: "What happened?" "Why did that happen?" The logic analyzer occupies a slot in the development station card cage and requires no separate connections.

A major asset of a logic analyzer is a feature which allows the user to "window" a particular piece of system activity or a particular kind of information status. Triggers are used to locate the window. The logic analyzer of the 64000 system can be commanded to trigger (begin or end gathering data) upon the occurrence of one of two conditions, a range of addresses, or after the multiple occurrence of a given state. Once trigger conditions are met, the data can be qualified further by

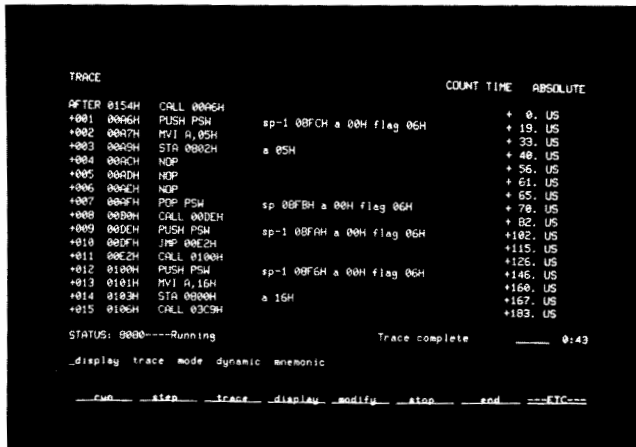

Figure 4. The logic analyzer function of Model 64000 transparently monitors the lines of the emulator bus. When state flow on the target system matches the trigger conditions, a trace is made of the system activity, which may be translated into programming mnemonics. The time elapsed after the trigger point is shown with each state in the right-hand column.

collecting only states that satisfy specified criteria, e.g., writes only, writes to a specified address range, etc. The same trigger parameters can be used to trigger external instruments, most commonly an oscilloscope, using the trigger output port.

As an aid to initial performance analysis, each state can be time-stamped by time measured from the trigger event or between traced states. This provides a bench-mark measure for comparing relative efficiency of alternate routines, checking execution time, or identifying a problem by finding anomalies in interevent time intervals.

Since the trigger conditions are "recognized" in hardware, execution speeds remain at real time. Displays are translated into the microprocessor mnemonics for convenience in interpreting the state flow (figure 4). The displays may also be shown in an appropriate numerical base.

PROM Programmer

The PROM programming system combines hardware and software to provide simple and efficient programming for most PROMs in use today. The universal PROM programming control card is installed in the card cage of the development station, and the appropriate personality module is mounted in the front panel. Then, programming of the PROMs is automatic, and all conventions for the selected PROM family are observed.

Model 64502A (Model 64001S Option 502) PROM Programmer contains the personality module for 2716 PROMs and the performance verification routines for the control card. This module is included with all PROM programmer options to provide the self-test module. A current list of PROM personality modules can be obtained from any HP Field Engineer.

System Software

Relocating macro assemblers and linkers are included with the appropriate emulator option. Assembler/linkers are also available for microprocessors not presently supported by an emulator option.

Pascal compilers are available currently for several microprocessors. These compilers use Pascal/64000, a modification of the "standard" Pascal language developed by Nicklaus Wirth, with extensions to facilitate separate compilation by modules and to better serve typical byte-oriented microprocessors. In two passes, source files are first

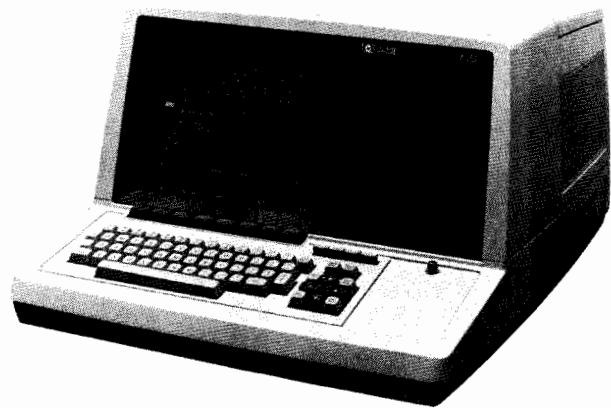

Figure 5. Model 64100A Development Station is the basic unit of the 64000 System. The development station houses all the system options, and is the interface between the user and the Logic Development System. Up to six development stations can be used with a printer and one or more hard discs.

translated into an intermediate data structure, and then to relocatable files which are, in turn, linked to form absolute files. The compilers give software designers the advantages of this modern, block-structured language.

Reliability and Maintainability

Extensive performance verification software and signature analysis documentation provide component-level troubleshooting for the Logic Development System. Service contracts are available and supported by the worldwide HP service staff. All major units of the 64000 System are manufactured by Hewlett-Packard and adhere to a uniform set of quality standards (figure 5). Software update service can be purchased for one-time updates for selected options or for an entire system for one year. The total software update service is available at a reduced price when included in a service contract.

Selecting a Logic Development System

Model 64000 Logic Development System is a complex system and, further, in most situations, it represents a major investment. It is recommended that you contact an HP Field Engineer or Logic Development System Specialist for suggested configuration for your design and development applications. Prices for some typical options are listed below.

Ordering Information

	Price
64001S Logic Development System for configuration	\$24,560 to \$130,000
Opt 040 Cartridge Tape Drive	\$1,800
Opt 100 Development Station	\$9,600
Opt 153 16k Byte Emulation Memory System	\$2,300
Opt 2XX Emulation System, 8-bit μ P	\$3,000
Opt 2XX Emulation System, 16-bit μ P	\$5,500
Opt 300 Logic Analyzer	\$1,800
Opt 302 48-Channel Logic Analyzer	\$2,500
Opt 502 PROM Programmer, 2716	\$700
Opt 81X Pascal Compiler, 8-bit μ P	\$2,000
Opt 81X Pascal Compiler, 16-bit μ P	\$3,000
Opt 8XX Assembler/Linker, 8-bit μ P	\$500
Opt 8XX Assembler/Linker, 16-bit μ P	\$1,050
64005S Emulation Terminal System	from \$16,700

LOGIC ANALYZERS

Simultaneous Time, State & Glitch Information

Model 1615A

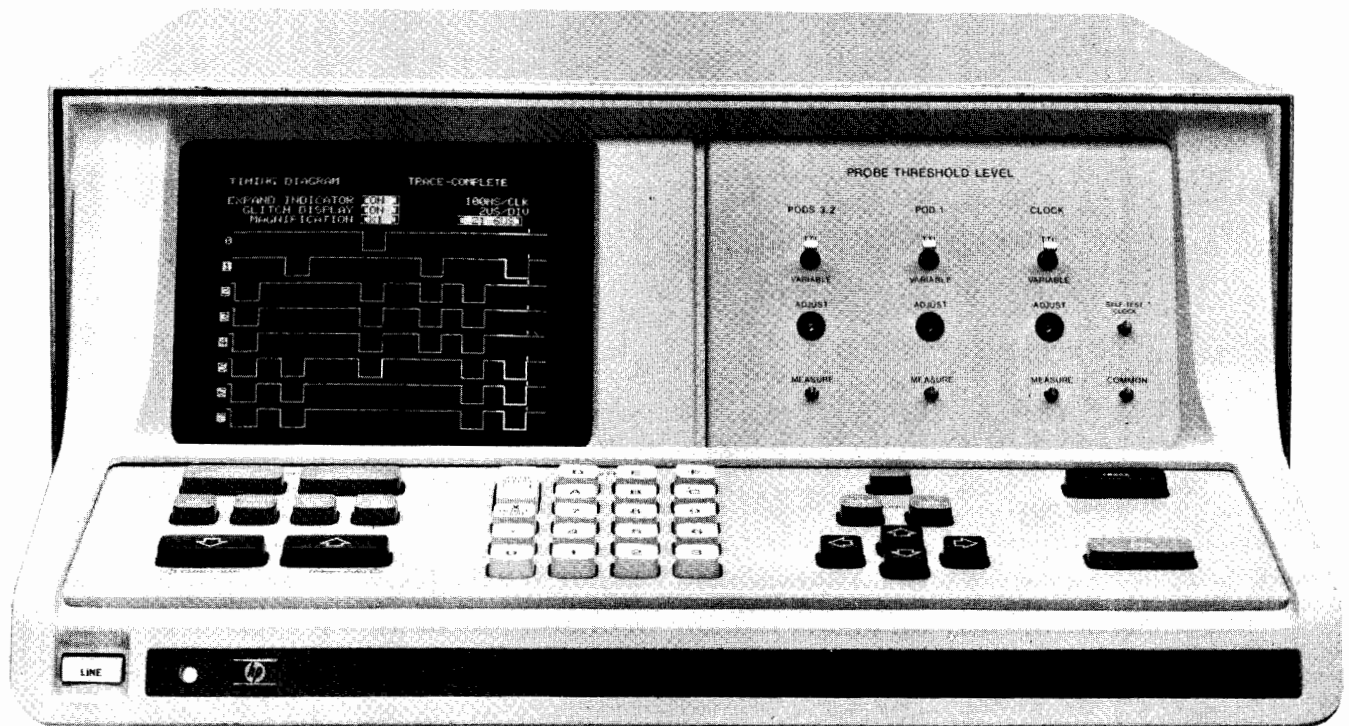

1615A



1615A Description

Hewlett-Packard's Model 1615A Logic Analyzer is two instruments in one, a timing analyzer and a state analyzer, for design and troubleshooting of digital systems. With Model 1615A, you can make timing measurements, state measurements, or both simultaneously. Using simple keyboard entries, the 1615A can be configured as an 8-bit timing analyzer, a combined 8-bit timing and 16-bit state analyzer, or 24-bit state analyzer, each with a memory 256 words deep. Powerful triggering capability, synchronous and asynchronous data capture modes, six clock qualifiers, and sophisticated delay functions assure that the timing and data information you need is collected.

The menu system simplifies measurement setups and eliminates the need for a complex, crowded keyboard. Mode of operation, state, time, or dual, is set with the Format Specification menu, and the test parameters are set with the Trace Specification menu. Each menu is an interactive display and parameters are either selected from a defined set or entered directly from the keyboard.

Asynchronous Measurements

The 1615A makes asynchronous measurements in the time mode of operation, the 8-bit mode. This mode is selected on the Format Specification menu, and clock source, clock slope, labels, logic polarity, and numerical base are also defined on the same menu. Then the Trace Specification menu is used to enter trace parameters. The trace point (trigger) may be placed at the beginning or end of the trace list, so you can view activity either preceding or following the point you specify. Either an external or internal clock may be selected. Up to three ORed trigger states can be entered, or using ON NOT as a trigger condition, any condition other than the one named will act as a trace point. NOT triggering is convenient for monitoring a status word for change, or, with a "don't care" trigger state in end mode, and an external clock, a system crash results in capture of the 256 events preceding the crash. A time or clock delay can be added to trigger conditions.

The 8-bit mode is truly asynchronous in pattern recognition. The pattern duration may be set from 15 to 2000 ns, and when a specified pattern exists for the duration selected, it will be registered by the analyzer even if it was not true when the clock occurred. This feature always produces positive triggering, even with narrow patterns or



The Trace Specifications menu shows the label assigned to the timing lines (E) and the numerical base in which to enter data. This Trace Specification causes the 1615A to use a 100 ns internal clock and begin data collection when any one of the three ORed 8-bit patterns occurs AND a glitch appears on channel 4.

very slow clocks. Glitches are treated as separate parameters, stored in a separate memory, and displayed uniquely, even when they occur at data transitions. Glitches can be added to trigger conditions.

Tracing in the 8-bit mode produces an eight-line timing diagram. Short, vertical bars between the timing lines indicate the location of the trace point. A few quick keystrokes arrange the channels in any order you wish and channels not needed can be turned off. Glitches are recognized by the 1615A any time multiple transitions across threshold occur more than 5 ns apart between sampling pulses. When the glitch display is turned on, glitches are shown as bright vertical bars or as brightened edges if they occur at a data transition. Any part of the display may be selected to be magnified by a factor of ten for a better display resolution. The expand indicator serves a dual purpose as it is also used to display readout of the time between any two selected points of the display.

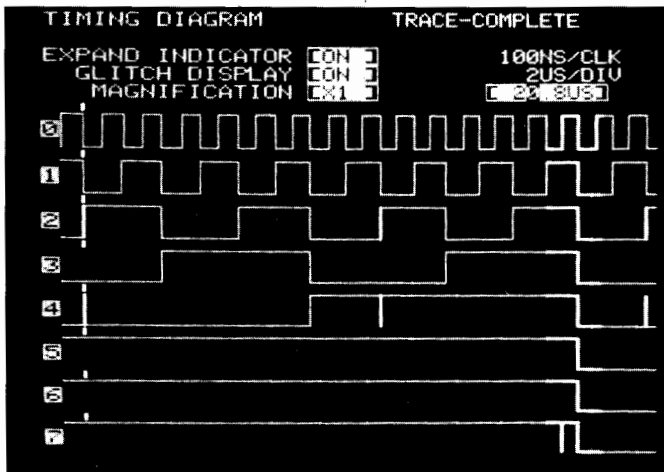

The 1615A displays timing information for up to eight lines and glitches which are displayed as vertical bars or brightened edges when they occur at a transition. A trigger point is indicated by a short vertical bar on each timing line, and is shown at the far left of this display. In addition, the sampling clock period and time per division are displayed.

Simultaneous Timing and State Measurements

Model 1615A captures asynchronous and synchronous activity simultaneously. Consequently, timing information can be traced relative to the occurrence of a specific state, or state flow can be monitored relative to a specific timing condition. Now you can monitor those critical "ripple through" paths and relate activity directly to program execution, or watch activity on both sides of an asynchronous I/O port. The 1615A dual mode of operation is the 16-bit and 8-bit mode, selected on the Format menu. Four interactive modes are offered on the Trace Specifications menu: 8-Bit Triggers/Arms 16-Bit and 16-Bit Triggers/Arms 8-Bit.

Timing Analyzer Registers Synchronous Data Collection

To observe state flow related to a timing event, either 8-Bit Triggers 16-Bit mode or 8-Bit Arms 16-Bit mode may be used. In trigger mode, the 1615A collects synchronous data as soon as the asynchronous trigger condition is met. Now you can observe state flow directly related to time events, such as activity on a data bus when an interrupt or glitch occurs. If you choose the arms mode, the 1615A will first find the asynchronous trigger, and only then search for specified point in the data flow. In this way you can view program activity, e.g., an output routine, only after a particular timing event occurs, such as a service request.

State Analyzer Registers Asynchronous Data Collection

Frequently it is necessary to check timing conditions preceding or following a specific point in program execution. In these situations, the 16-bit state analyzer portion of the 1615A sets conditions for displaying a timing diagram, using either the 16-Bit Triggers 8-Bit mode or 16-Bit Arms 8-Bit mode. A typical application is viewing activity on status or data lines to an input port shortly before reading data at that port. This is accomplished simply by monitoring state flow until the address of that port appears; then in End trace, 16-Bit Triggers 8-Bit, the display would be a timing diagram of activity on the control lines for the period just prior to addressing the port.

Synchronous Measurements

The quickest way to find faults in a state machine is monitoring program execution, because any malfunction in the machine is reflected by a corresponding deviation in program sequence. Model 1615A is a powerful state analyzer in the 24-bit mode of operation. The 24 lines may be grouped by up to three labels, and each label group is then treated as a separate variable. Logic polarity and numerical base (hexadecimal, decimal, octal, or binary) is assigned to each label set. The 24-bit trigger may be placed at the beginning or

end of the 256-word trace list; any bits not required for the trigger word may be set to X for "don't care." Six clock qualifiers may be used and are set to 1, 0, or X from the keyboard in one or two ORed fields. Delays to 999 999 may be entered for number of states or number of trigger occurrences. The display is either a sequential list of monitored states or only trigger words. Fifteen lines are visible on the display at any time, and the left column is the location of each line in the analyzer's memory. Other portions of the trace list are viewed by using the roll keys or entering the memory location number. The trigger word is shown in inverse video.

HP-IB Interface Bus for Measurement Systems Applications (Opt 001)

Hewlett-Packard Interface Bus (HP-IB) is HP's implementation of IEEE Standard 488-1978. An HP-IB configuration is available for Model 1615A on initial order as Option 001, or can be installed at a later date with Model 10069A HP-IB Interface Field Kit. With HP-IB, the 1615A can be configured for automatic functional testing of digital systems. Combined with a controller, such as HP Model 9825A, data captured by the logic analyzer can be transferred to the controller for automatic analysis. Hard copy of menus, data lists and timing diagrams can be produced by a variety of HP-IB compatible printers and plotters. In the laboratory, the speed and ease with which data is accumulated, summarized, and documented in hard copy lets you spend more time on analysis and design and less time in data collection. In production, automated testing reduces time and cost for making extensive tests on systems and subassemblies. Test programs with built-in operator instructions decrease testing costs even further by cutting training costs and providing uniform test procedures.

The primary advantage of computer control is the execution of complex, time-consuming measurement routines with minimal operator involvement. Trace parameters can be set and the data can be read, stored and compared. Branching decisions can be programmed which are based on the data collected by the 1615A. Data can be translated from assembler code to mnemonic code, or used for statistical computations. Operator prompts and computational results can be displayed on the 1615A CRT. Documentation can be collected directly with hard copy from a printer or plotter.

Many measurements not possible with stand-alone instruments become practical with the HP-IB interface. In the laboratory, a controller operated system can present statistical results graphically, as with

TRACE LIST		TRACE-COMPLETE
LINE NO.	A HEX	C HEX
000	03E3	E1
001	03E4	03
002	03E1	1D
003	03E2	C2
004	03E3	E1
005	03E4	03
006	03E1	1D
007	03E2	C2
008	03E3	E1
009	03E4	03
010	03E1	1D
011	03E2	C2
012	03E3	E1
013	03E4	03
014	03E1	1D

A trace list of synchronous activity in the 24-bit mode of operation can be grouped under any of four labels, with a separate numerical base for each label group. In this trace two labels are used, both in hexadecimal base, and only addresses of the form 03EX₁₆ are captured for display.



a bar graph or cumulative curve of the number of calls to a subroutine or interrupt hits. Continuous monitoring routines can compare data acquired by the 1615A to stored data and then branch to restart a sequence or to collect other data. For better maintenance, particular control lines or subroutines can be monitored automatically and signals output when marginal operating conditions indicate a need for service (e.g., service a tape drive as a function of rewrite activity or parity check errors). In production, automated measurements are made more consistently and can be performed more quickly for better quality control and greater throughput.

Probes

Input data are sensed through 24 high impedance probes at rates to 20 MHz. The data probes are in three 8-bit pods for easier connection to the system under test. The fourth pod contains the clock probe, six qualifiers, and an external trigger. Threshold level is set on the front panel for TTL level, or adjusted in a range from -10V to +10V. It is possible to set one threshold for 16 data lines, a second threshold for the other eight data lines, and a third threshold for the clock pod, allowing you to make simultaneous measurements on systems comprised of several logic families, ECL, TTL, MOS, etc.

The front section of each probe may be disconnected from its pod, permitting individual leads to be wired into connectors for particular systems. Additional probe lead kits, probe tips, and minicomputer interfaces are available to simplify set up and connection. Refer to the Logic Analyzer Accessories, pages 188 to 193.

Trigger Outputs

Once you have delineated a problem area with the 1615A Logic Analyzer, you may want to use other measurement instruments for further investigation, e.g., an oscilloscope for more detailed timing analysis. The logic analyzer's state trigger output is stable with respect to the system clock, and provides a reliable reference point for triggering other instruments. The timing trigger output is based on the pattern recognition trigger at the probe, and can be used in the same manner as a state trigger point. A trace point output is also available to generate interrupt signals or "clock stopper" circuits in other parts of the system under test.

Self Test

Self-test capability confirms the proper operation of the 1615A. During turn-on, a self-test to check ROM/RAM is performed automatically and a message on the analyzer display indicates completion of this test. Keyboard, data acquisition and two data stream analysis self-tests can be initiated from the keyboard if desired.

1615A Specifications

Operating Modes

24 Bit (State): for asynchronous monitoring of one or more buses with combined width up to 24 bits.

8 Bit (Time): for asynchronous monitoring of control line activity or any asynchronous data lines.

16 Bit & 8 Bit (simultaneous State and Time)

16 Bit Triggers 8 Bit: 16-bit state trigger point is reference point for acquisition of 8-bit timing data.

16 Bit Arms 8 Bit: sequential trigger, 16-bit state trigger point initiates search for 8-bit timing trigger.

8 Bit Triggers 16 Bit: 8-bit timing trigger is reference point for acquisition of 16-bit state data.

8 Bit Arms 16 Bit: sequential trigger, 8-bit timing trigger point initiates search for 16-bit state trigger.

Clock, Qualifier, and Data Inputs

Repetition rate: to 20 MHz.

Input RC: 100 kΩ shunted by ≤5 pF at probe body.

Input threshold: TTL, fixed, ≈ +1.4 V; variable ±10 Vdc.

Maximum input: -40 V to +40 V.

Dynamic range: -15 V to +15 V.

Minimum Input

Swing: 0.6 V

Clock pulse width: 20 ns at threshold level.

Setup time: data must be present 20 ns prior to clock transition.

Hold time: time data must be present after clock transition, zero.

Synchronous Operation

Trigger delay: to 999 999 clocks.

Trigger occurrence: to 999 999.

Asynchronous Operation

Sample rate: 2 Hz to 20 MHz.

Data skew: 9 ns max.

Minimum detectable glitch: 5 ns with 30% peak overdrive or 250 mV, whichever is greater.

Glitch trigger: on any selected channel(s), if a glitch is captured, the glitch is ANDed with the asynchronous pattern trigger.

External trigger pulse width: 5 ns min with 30% peak overdrive or 250 mV, whichever is greater.

Pattern trigger: any 8-bit pattern. Trigger duration required is selectable 15, 50, 100, 200, 500, 1000, or 2000 ns ±15 ns or 15%, whichever is greater.

Delay time: to 1 048 575 x sample period.

Trigger Outputs (Rear Panel)

16/24 Bit Trigger Output

Level: high, ≥2 V into 50Ω; low, ≤0.4 V into 50Ω.

Pulse duration: ≈25 ns.

Delay from input clock: ≈85 ns.

16/24 Bit Trace Point Output

Level: high, ≥2 V into 50Ω; low, ≤0.4 V into 50Ω.

Pulse duration: starts at beginning of trace and ends at trigger point (pattern trigger plus delay).

Delay from input clock: ≈85 ns.

8 Bit Pattern Output

Level: high ≥2 V into 50Ω; low ≤0.4 V into 50Ω.

Pulse duration: pattern duration minus asynchronous trigger duration width.

Delay from pattern at probe: ≈75 ns plus synchronous trigger duration width.

General

Memory depth: 256 data transactions (in timing display mode, 249 samples are displayed).

Power: 100, 120, 220, 240 Vac; -10% to +5%; 48 to 66 Hz; 230 VA max.

Size: 189 H x 426 W x 664 mm D (7 7/16" x 16 3/4" x 26 1/8").

Operating Environment

Temperature: 0°C to +55°C.

Humidity: up to 95% relative humidity at +40°C.

Altitude: to 4600 m (15,000 ft).

Vibration: vibrated in three planes for 15 min. each with 0.3 mm (0.015 in.) excursions, 10 to 55 Hz.

Weight: net, 19.1 kg (42 lb); shipping, 23.6 kg (52 lb).

Accessories supplied: three 8-bit Model 10248C data probes and one Model 10248C clock probe with probe leads and tips (three probes for data and one probe for clock, qualifiers, and external trigger), one 2.3 m (7.5 ft) power cord, and one Operating and Service Manual.

Ordering Information

1615A Logic Analyzer

	Price
Opt 001: HP-IB Interface	\$7500
Opt 002: add 10277B Opt 001 GP Probe Interface	add \$500
Opt 003: add 10275A UNIBUS Interface and 10277B Opt 001	add \$700
Opt 004: add 10276A Q-Bus Interface and 10277B Opt 001	add \$775
Opt 005: add 10278A HP 1000 M/E/F Series Interface and 10277B Opt 001	add \$1050
Opt 006: add 10279A NOVA 3 Interface and 10277B Opt 001	add \$900
Opt 007: add 10280A microNOVA Interface and 10277B Opt 001	add \$900
Opt 008: add 10285A HP 1000 L Series Interface and 10277B Opt 001	add \$750
Opt 009: add 52126A Multibus Interface and 10277B Opt 001	add \$700
Opt 010: add 10066A HP-IB Probe Interface	add \$300

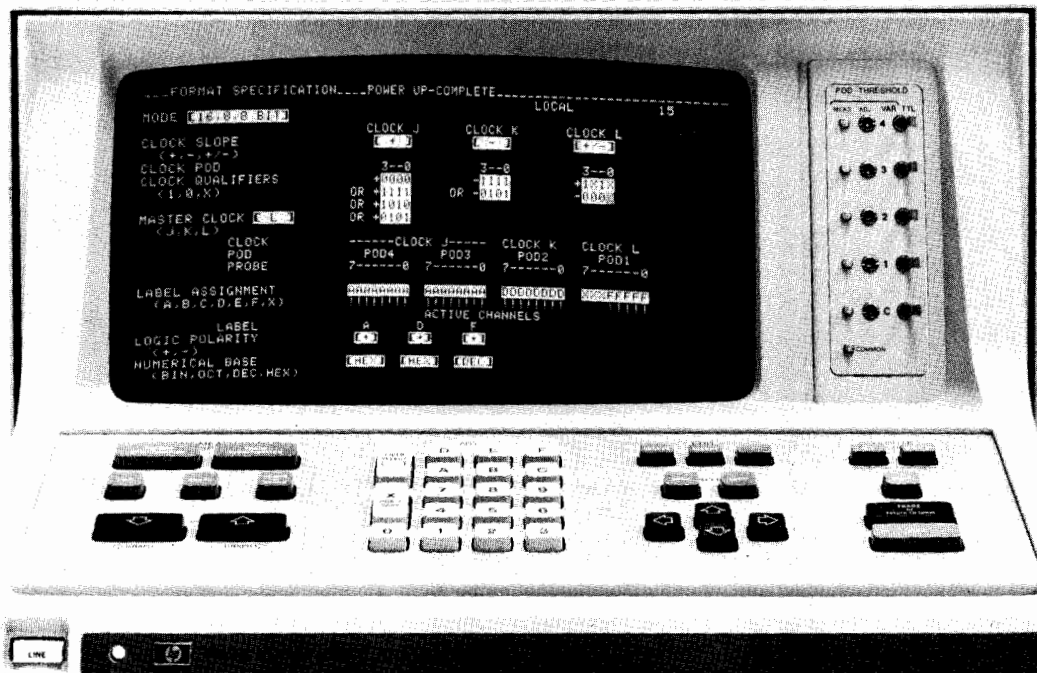

1610B



1610A and 1610B Description

Hewlett-Packard Models 1610A and 1610B Logic State Analyzers offer general purpose measurements in microprocessor-based systems, minicomputers, or virtually any digital circuits. Model 1610B includes the feature set of Model 1610A, and other features, most notably the addition of multiple clocks and clock qualifiers for direct monitoring of multiplexed data flows. The 1610 performs synchronous real-time traces at speeds to 10 MHz with an extensive triggering capability on as many as seven sequential words, each as wide as 32 bits. A simple, functionally organized keyboard together with the interactive display are combined in the menu concept, allowing you to focus your analysis work, capturing only pertinent data.

Measurements of system activity are displayed on the analyzer's CRT screen in selectable hexadecimal, octal, binary, or decimal codes. Setup for a measurement is aided with the Format and Trace specification menus which indicate the test parameters you are to enter. Data is strobed into Model 1610A with the selected edge of the analyzer clock, while Model 1610B uses a combination of edges and qualifiers of three clocks. The events and activity that are captured and displayed from the system are gathered at clock transitions after the 1610 locates the specified trace position and then captures 64 words of data. The displayed trace may be a simple breakpoint with the trace position at the beginning, end, or center of the captured data; or, in a state sequence where one to seven words must be found in a specified order before data is captured. This state sequence permits you to directly locate sections of branched, looped, or nested loops of state flow. A selective trace of from one to seven words may be OR specified which allows only the words of interest to be captured and eliminates data that is not necessary for your measurement.

A count measurement capability allows you to perform a time or state count on all 64 traced states in either absolute or relative modes. With the count measurement you can determine how much time a program spends in loops, servicing interrupts, as well as the time between program steps. This measurement is performed simultaneously with the trace and all 64 words traced are assigned a count record which is displayed as positive or negative time in relation to the loca-

tion of the trace position (absolute mode), or in relation to the previously acquired state (relative mode).

One complete measurement, including Format and Trace Specifications, may be internally stored to be recalled at a later time or for use in a trace compare mode. When a trace compare mode is called, the display presents an exclusive OR tabular listing of the differences between the current and stored measurements. The trace compare mode may be also used to direct the Analyzer to continuously rerun a measurement until the current and stored measurements are equal, or not equal, and the 1610 automatically halts and retains the current measurement.

The 1610 includes a Trace Graph to provide a display of data magnitude versus time sequence for all 64 words in memory. Each dot representing a word is given a vertical displacement corresponding to its magnitude and is positioned horizontally in the order of its occurrence. The result is a graph that offers a quick overview of program operation.

For increased confidence of the instrument's operation, there are self-tests for the keyboard, ROM/RAM, display, a trace test which includes all probe pods, an interrupt test, and a printer test.

Hard copy of both the Format and Trace specifications as well as the Trace List and Trace Compare can be obtained by adding a Hewlett-Packard printer (Model 9876A). Rear panel printer outputs are included in the 1610 for direct interfacing.

With Option 003 or a field installation kit, both models can be used with any of the family of HP-IB instruments. HP-IB is Hewlett-Packard's implementation of IEEE Standard 488-1978 interface bus. With the HP-IB capability, a controller such as HP Model 9825A Desktop Computer can be added for automated analysis, data reduction, and test procedures.

Data Entry

Entries are made in inverse video fields with the entry location indicated by a blinking cursor. Entry fields (enclosed with brackets) are multiple choice with the desired test parameter selected by using the Field Select key (e.g. positive or negative edge of clock transition).



Models 1610A and 1610B (Cont.)

Trace specifications are entered through the keyboard directly in octal, hexadecimal, binary, or decimal notation which permits working in a familiar format without worrying about base conversions.

Menu

The displays which are called up by keyboard commands are referred to as menus because they include the selections for setting up test parameters and labeling of test results. These menus include Format Specification, Trace Specification, Trace List, Trace Compare, and Trace Graph.

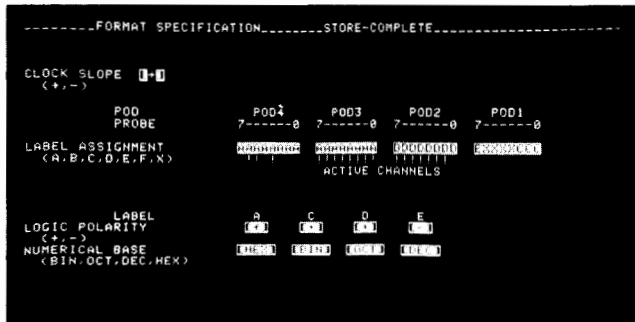

Format specification menu of Model 1610A lets you define which group of bits will act as a unit by assigning labels which may be separately defined as to numerical base and polarity. The allowed selections are defined on-screen to minimize front panel controls.

Format Specification

The formatting capabilities allow you to separate the 32 input data channels into the desired test parameters. This allows those data bits which act as a unit to be assigned to one of six labels (e.g. 16 bits of address bus assigned as "A" and 8 bits of data bus assigned as "D"). This labeling capability then permits all trace specifications to be assigned as a unit rather than on individual lines. Each assigned label may be independently defined in positive or negative logic as well as different bases of binary, octal, decimal, or hexadecimal. Another feature of this menu is that active channels are shown as exclamation marks (!) for a quick overview of system activity.

Model 1610B offers multiphased, qualified clocking. The three clocks can be set in three modes: 32-bit, 16-16 bit or 16-8-8 bit. In the 32-bit mode, all data present on the four data pods are clocked into the logic analyzer simultaneously on all selected active edges of the ORed combination of clocks J, K, and L. For each clock there are four choices for the active edge: positive edge (+), negative edge (-), both edges (+/-), or off. For each clock used, there are up to four qualifier minterms. A minterm bit may be set to 1, 0, or X (don't care). In the 16-16 bit mode, data from pods 4 and 3 are strobed into the logic analyzer with clock J, and data from pods 2 and 1 are

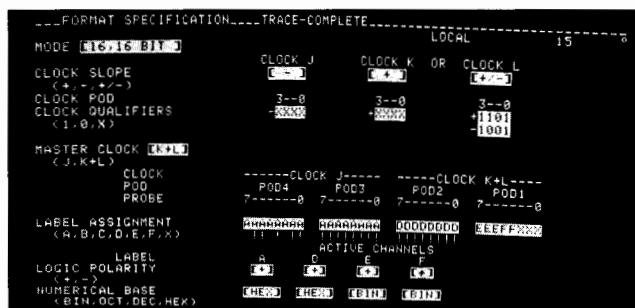

Model 1610B offers up to three clocks, used independently or in ORed combinations. For active clocks, either or both edges can be used to strobe data into holding registers on the current list, and each clock can be qualified with up to four minterms.

strobed in with the ORed combination of clocks K and L. The master clock, J or K+L, is set on the menu, and is the last to occur in the sequence of events monitored. Data from the other clock(s) are put in a holding register and transferred to the trace list with the edge of the master clock. In the 16-8-8 bit mode, all three clocks are used independently with data on pods 4 and 3 strobed in by clock J, data from pod 2 strobed in by clock K, and data on pod 1 strobed in by clock L.

Trace Specification

After the Format Specifications have been defined, the Trace Specification menu is called up and the measurement parameters are entered. The Trace measurement may be defined as a single word or may be in a sequence of from one to seven words which must be found in the specified order. The ability to select a sequence of words allows

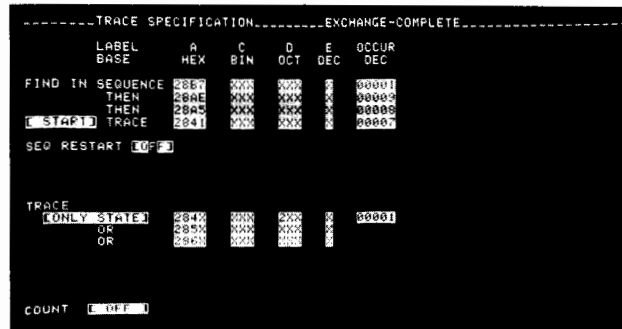

Typical trace specification for defining a test sequence that will capture a nested loop as well as only selected states in the loop.

you to locate sections of branched, looped, or nested loops during machine operation. To further qualify the sequence, each word in a sequence may be specified to occur from 1 to 65 536 times so you can capture the nth pass of a loop beginning at a given word.

A Sequence Protect function is included with Model 1610B. When Sequence Protect function is ON, data acquisition is accomplished in the same manner as with Model 1610A. No data but the sequence terms are stored until after the last sequence term is found. When the Sequence Protect function is OFF, data is stored immediately after the beginning of the trace and is displayed relative to the trace point position. Rather than listing the sequence terms, the display shows only SEQUENCE FOUND. When the trace is centered or placed in end trace mode, the sequence terms which are a part of the trace are not labeled as sequence terms.

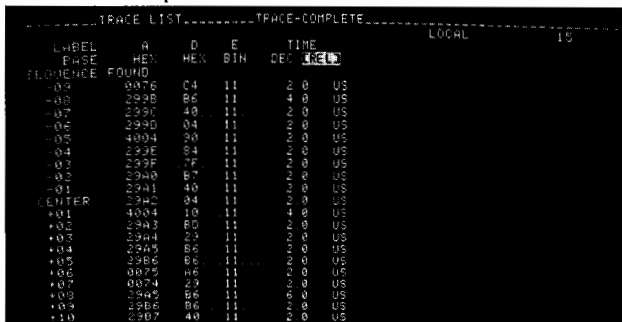

When the Sequence Protect function of Model 1610B is off, the logic analyzer begins data storage immediately at the beginning of the trace. Rather than showing the sequence words separately, the remarks SEQUENCE FOUND is displayed. Sequence terms are not labeled.

Trace List

When the Trace key is pressed, the 1610 searches for the word sequence defined in the Trace Specification. As the data is captured it is displayed on the CRT along with a line number and alphabetically formatted into the assigned labels and in their numerical base. The display contains 20 words, and Roll keys permit you to view the entire 64 word listing. To make it easier to locate the Trace position, which may be selected to start, be in the center, or end a trace, Start is spelled out on the display. Any count information is also presented adjacent to each word.

The count measurement may be specified to be either Time or State (word) count for all 64 words in memory and may be in either absolute mode or relative mode. The absolute mode gives you the time or count between the trace position and a selected word, while the relative mode presents the time or count between each consecutively acquired state. This allows you to directly determine the time spent in loops, interrupts, or program time between steps.



```

----- TRACE LIST ----- EXCHANGE-COMPLETE -----
LABEL      A      C      D      E      TIME
BASE      HEX   BIN   OCT   DEC   DEC
SEQUENCE  2887  000  286  1  1 003 S
SEQUENCE  289E  000  296  1  1 000 S
SEQUENCE  28A5  000  296  1  00 00 MS
START     2841  000  000  1  6 049 MS
+01      2842  000  232  1  4 0  US
+02      2843  000  000  1  2 0  US
+03      2844  000  232  1  4 0  US
+04      2845  000  002  1  2 0  US
+05      2846  000  200  1  4 0  US
+06      2847  000  092  1  1 2 0  US
+07      2848  000  046  1  1 0  US
+08      2849  000  084  1  1 0  US
+09      284A  000  212  1  2 0  US
+10      284B  000  000  1  1 0  US
+11      284C  000  204  1  1 0  US
+12      284D  000  092  1  1 0  US
+13      284E  000  316  1  1 0  US
+14      284F  000  050  1  1 0  US
+15      2850  000  744  1  1 0  US
+16      2851  000  010  1  1 0  US
    
```

Trace list displays the label and numerical bases, as well as the sequence requirements and resulting state flow. This example also shows time in the relative mode which is the elapsed real time between each state and the previously acquired state.

Model 1610B offers two additional features for ease of operation. Pressing the Default key after rolling the display returns the listing to the initial trace point. A memory retrieval function has been added and is entered by holding down the Stop key for two or three seconds. This is useful when a clock has failed or trigger conditions were not met. The trace is aborted and up to 63 states of the most recent transaction in memory are displayed with a remark, either HISTORY AT STOP or NO HISTORY AVAILABLE.

Trace Graph

Trace Graph is a presentation of data magnitude versus time sequence which provides a display of all 64 words in memory. This graph allows you to see at a glance in which part of a program the machine under test is operating. Each word is displaced vertically according to its magnitude and positioned horizontally in order of its occurrence. The data to be graphed is selected by label with its base displayed on screen.

The trace graph mode is the same for both models with the exception that the graph display of Model 1610B indicates whether the graph is generated from current trace or a stored trace.

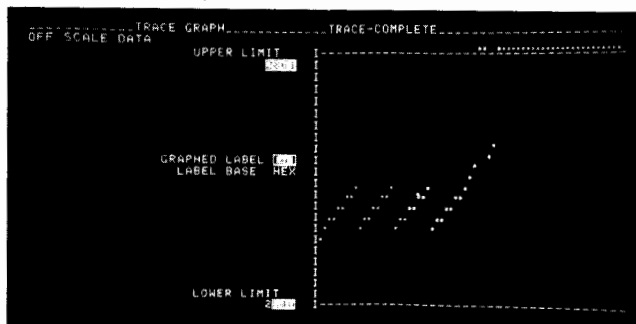

A trace graph may be selected to give you a view of all 64 states in the analyzer's memory. Each dot's vertical position is determined by its numerical value and its horizontal position is determined by its time sequence of occurrence.

Trace Compare

One complete trace measurement including format and specification may be stored internally which allows comparison between a current and stored measurement. The current and stored measurement may also be interchanged which allows you to quickly review the stored measurement as well as its specifications.

Trace Compare presents an exclusive OR tabular listing of the differences between the current and stored measurements. The listing is formatted and rolled as a trace list with identical bits displayed as zeros and different bits displayed as nonzeros. For example, in the octal base, 03 is equivalent to a binary 000 011 which means that the least significant bits are different in the two measurements. A compared Trace mode is also available which directs the 1610 to continuously rerun a measurement until the current and stored measurements are either equal or not equal which makes it much easier to capture intermittent problems.

HP-IB Interface

HP-IB Interface may be added initially with Model 1610A or 1610B as Option 003 or installed later with a field kit. With the HP-IB interface, you can combine the 1610 with any instrument that is HP-IB compatible, such as printers, plotters, external memories, and computing controllers.

The most common configuration is the addition of a computing controller, such as 9825A Desktop Computer, and a printer and/or plotter for automatic operating modes. In the laboratory, data can be accumulated, summarized, and documented quickly. Statistical computations can be completed automatically, with results displayed on the logic analyzer and hard copy. Making your analyzer "programmable" drastically reduces time and cost of making production tests by reducing, and sometimes eliminating, the need for constant surveillance by highly skilled operators. Testing becomes standardized, and operator prompts can be built-in, simplifying training and decreasing the number of operator errors. Babysitting (continuous, long-term monitoring) can be done unattended, with branching instructions and resetting done by the controller. Maintenance of a digital system is streamlined and focused on prevention rather than repair by using the analyzer/controller combination to flag marginal operation in subunits of software and hardware.

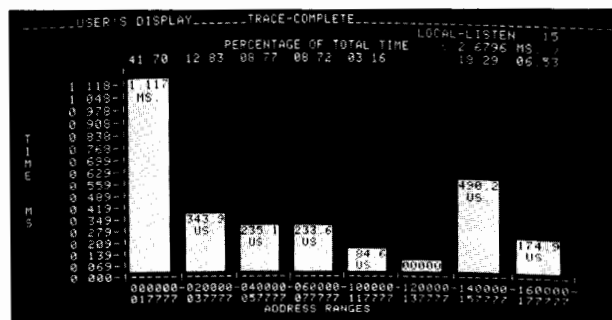

When the HP-IB interface is used with a controller, data collected by the analyzer and user-defined menus are transferred to the controller. In this example, the controller counts the events occurring in each address range, and displays the results, with percentages, as a histogram on the 1610 CRT.

Probes

Input data is sensed through 32 high impedance probes at rates to 10 MHz. Data probes are separated into four 8-bit pods for easier connection to a system, with a fifth probe pod for connecting to a clock source. To make it easier for connecting to different systems, the front section of each probe may be disconnected from its pod. This allows the individual probe leads for each probe pod to be wired to connectors for specific systems. Additional probe lead kits as well as probe tips are available separately as accessories.

```

----- TRACE COMPARE ----- COMPARED TRACE-COMPLETE -----
LABEL      A      C      D      E      COMPARED
BASE      HEX   BIN   BIN   DEC   TRACE MODE
START     0000  000  00000000  0  0
+01      0000  000  00000000  0  0
+02      0000  000  00000000  0  0
+03      0000  000  00000000  0  0
+04      0000  000  00000000  0  0
+05      0000  000  00000000  0  0
+06      0000  000  00000110  0  0
+07      0000  000  00000000  0  0
+08      0000  000  00000000  0  0
+09      0000  000  00000000  0  0
+10      0000  000  00000000  0  0
+11      0000  000  00000000  0  0
+12      0000  000  00000000  0  0
+13      0000  000  00000000  0  0
+14      0000  000  00000000  0  0
+15      0000  000  00000000  0  0
+16      0000  000  00000000  0  0
+17      0000  000  00000000  0  0
+18      0000  000  00000000  0  0
+19      0000  000  00000000  0  0
    
```

The trace compare mode offers an exclusive OR comparison of stored versus active data. In this example, the 1610 stopped data acquisition when the active data was not equal to the stored data at state +06.



1610A and 1610B Specifications

Clock and Data Inputs

Repetition rate: to 10 MHz.
Input RC: 100 kΩ shunted by approx 5 pF at probe body.
Input threshold: TTL, fixed at $\approx +1.5$ V; variable, ± 10 Vdc.
Max input: -40 V to +40 V.
Dynamic range: -15 V to +15 V.

Min Input

Swing: 0.6 V.
Clock pulse width: 20 ns at threshold level.
Edge-to-edge timing: (1610B) master active edge to master active edge, 100 ns; master active edge to next slave active edge, 20 ns; slave active edge to slave active edge, zero.
Data setup time: time data must be present prior to clock transition, 20 ns.
Hold time: time data must be present after clock transition, zero.

Trigger and Meas Enable Outputs

Trigger output (rear panel): a 50 ns ± 10 ns positive TTL level trigger pulse is generated each time the trace position is recognized. If the trace position includes a word sequence, the pulse occurs when the last word is found. Trigger outputs continue until a new specification is traced or the Stop key is pressed. Pulse rep-rate is 0 to 10 MHz depending on input data rates. In continuous or compared trace modes, the internal display process blanks out pulses for 100 μ s at rep-rates of < 20 Hz.

Measurement enable output (rear panel): (1610A, serial number prefix 1812 or below) the positive TTL level measurement enable output goes high and remains high when the 1610A is looking for a trace position and goes low when a trace position is recognized or if the Stop key is pressed. In continuous or compared trace modes the transitions repeat each time the 1610A makes a new measurement. (1610A, serial number prefix 1822 or above, and 1610B) two BNC rear panel outputs for TTL-level measurement enable. One BNC outputs a signal which goes high and remains high when the analyzer is looking for a trace position and goes low when a trace position is recognized or Stop key is pressed. Other BNC goes low and remains low when the analyzer is looking for a trace position and goes high when a trace position is recognized or Stop key is pressed.

Delay from input clock: ≤ 150 ns.

General

Memory depth: 64 data transactions; 20 transactions are displayed on screen, roll keys permit viewing all 64 data transactions.
Time interval: resolution, 100 ns; accuracy, 0.01%. Maximum time, 429.4 seconds.
Events count: 0 to $2^{32} - 1$ events.

Power: 100, 120, 220, 240 Vac; -10% to +5%; 48 to 63 Hz; 260 VA max.

Rear panel BNC output: 5 V, 100 mA output for logic probe or other accessories.

Size: 230 H x 425 W x 752 mm D ($9\frac{1}{16}$ " x $16\frac{3}{4}$ " x $29\frac{5}{8}$ ").

Operating Environment

Temperature: 0°C to +55°C (+32°F to +132°F).
Humidity: up to 95% relative humidity at +40°C (+104°F)
Altitude: to 4600 m (15 000 ft).
Vibration: vibrated in three planes for 15 min. each with 0.25 mm (0.010 in.) excursions.

Weight: (1610A) net, 26.5 kg (58.5 lb) shipping, 32.2 kg (71 lb). (1610B) net, 23.8 kg (52.5 lb); shipping, 29.4 kg (65 lb).

Accessories supplied: four 10248C data probes and one 10247A clock probe for 1610A; five 10248C data probes for 1610B; one 2.3 m (7.5 ft) power cord, one Operating manual, and one Service manual.

Ordering Information

	Price
1610A Logic State Analyzer	\$11,000
1610B Logic State Analyzer	\$12,500
Opt 003 (1610A) HP-IB Interface	add \$800
Opt 003 (1610B) HP-IB Interface	add \$700
Opt 004 adds 9876A Thermal Printer	add \$3950
Opt 005 adds 10277A/B Opt 001 GP Probe Interface	add \$400
Opt 006 adds 10275A UNIBUS Interface and 10277A/B Opt 001	add \$700
Opt 007 adds 10276A-Q-Bus Interface and 10277A/B Opt 001	add \$775
Opt 008 adds 10278A HP 1000 M/E/F Series Interface and 10277A/B Opt 001	add \$1050
Opt 009 adds 10279A NOVA 3 Interface and 10277A/B Opt 001	add \$900
Opt 010 adds 10280A microNOVA Interface and 10277A/B Opt 001	add \$900
Opt 011 adds 10285A HP 1000 L Series Interface and 10277A/B Opt 001	add \$750
Opt 012 adds 52126A Multibus Interface and 10277A/B Opt 001	add \$700
Opt 015 adds 10066A HP-IB Probe Interface	add \$300
10494A HP-IB Interface Kit for 1610A Serial Number Prefix 1812A and below	\$1200
10495A HP-IB Interface Kit for 1610A Serial Number Prefix 1822A and above	\$900
10496A HP-IB Interface Kit for 1610B	\$800
10499A Field Retrofit Kit to upgrade 1610A (Serial Number Prefix 1940A and above) to 1610B	\$1800

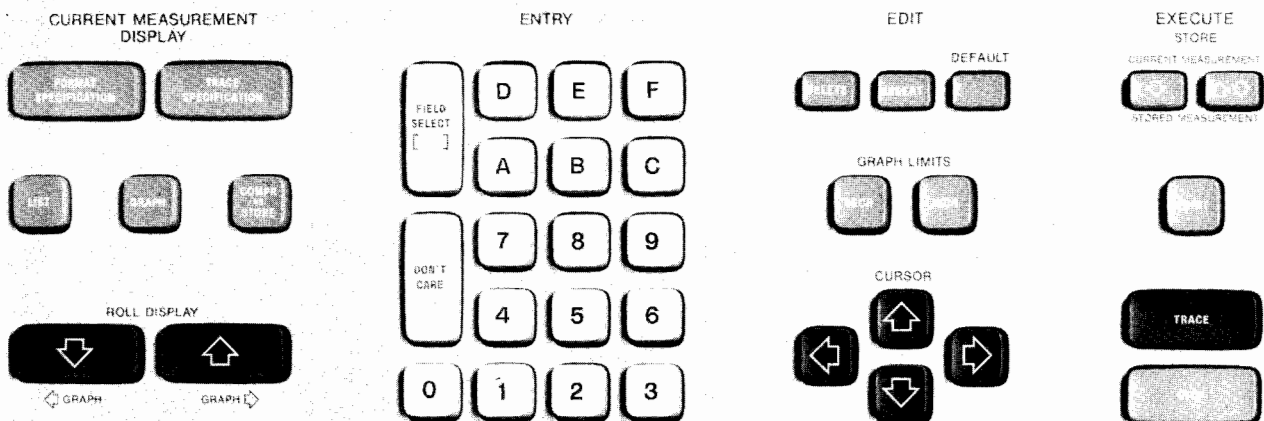

Logically arranged Logic State Analyzer keyboard, divided into functional blocks, and an interactive display, allow entry of complex measurements with a minimum of controls.

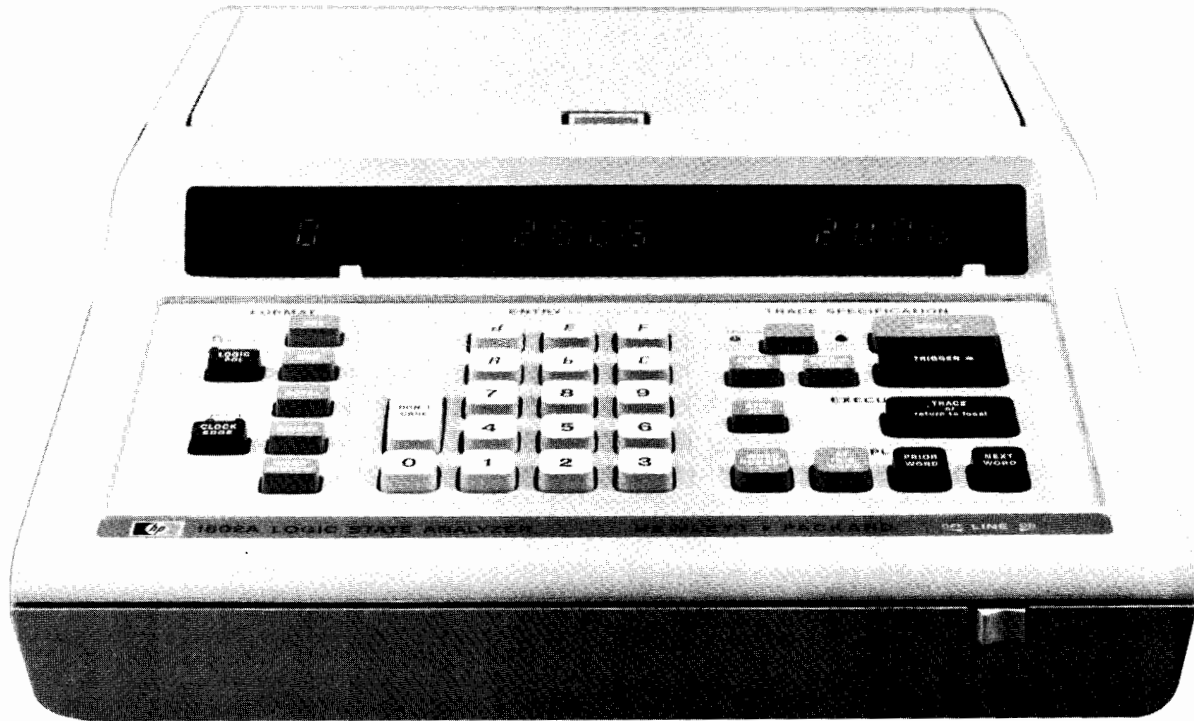

1602A



1602A Description

Hewlett-Packard's easy-to-use low-cost Model 1602A keyboard controlled Logic State Analyzer is for use in the design and troubleshooting of digital systems. The 16-bit wide and 64-word deep memory operates at clock speeds to 10 MHz allowing the instrument to capture virtually any 64-word sequence in a system. The data may be registered with versatile pattern recognition trigger and digital delay. Measurements of system activity are displayed on the Analyzer's LED readout in hexadecimal, octal, or binary format, which eliminates the need for base conversions by the operator. Keyboard entry of the desired trigger is in the same base as selected for the display.

A Hewlett-Packard Interface Bus option (HP's implementation of IEEE Standard 488) allows you to make automated functional tests

of digital systems. This means more consistent and repeatable measurements as well as more thorough testing because the test speed of the automated system allows more measurements in a shorter time in both production and service environments.

Ease of Use

The 1602's keyboard with its key-per-function layout is basically self-teaching. Entry of triggering and display conditions is a series of self-explanatory keystrokes with all entries displayed as they are entered enabling you to check their accuracy every step of the way.

Data Probe

The simplicity of the Analyzer starts with the probe which is a single pod containing all 16 data lines, clock, qualifier, and ground. At the front of the pod is a standard edge connector which allows you to quickly move the test connection from an address bus to the data bus, control lines, or I/O structures. You need only incorporate a few simple mating printed circuit board connectors in your system.

Tracing Data Flow

Capturing data flow is also easy and only requires a logical sequence of key strokes. The first item to define is the Logic Polarity of your system by pressing the Logic Polarity key. The panel LED's indicate your selection, positive for high true and negative for low true. Next select the clock edge on which you want to gather data which is also indicated by panel LED's.

Now select the display format that you want to use for the test. If you are running tests on an address or data bus, you would most likely select either hexadecimal or octal display format. However, if the test is on an I/O bus with numerical data, decimal may be preferred. For activity on control lines, binary is a meaningful base. In all cases the display indicates the selected format with a base (b) notation on the right. Many times all of the input lines are not used and if you want to blank the more significant bits, just press the Word Width key and enter the number of bits to be displayed from 2 to 16.

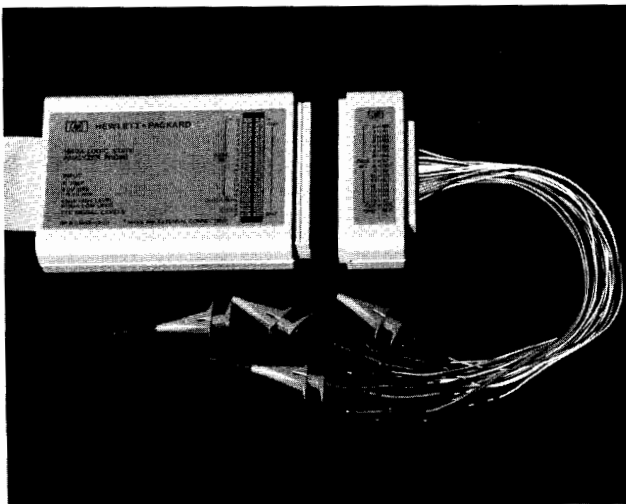

Model 1602A (Cont.)

The desired data window is entered from the Trace Specification section of the keyboard. If you want to view data after the desired trigger point, press Trigger Plus Delay Starts Trace which directs the 1602A to start collecting data as soon as the Trace Specification is satisfied. If you are more interested in data preceding the trigger point, select Trigger Plus Delay Ends Trace. For either mode, Start or End, an LED indicates the selected mode.

To define a trigger point, press the Trigger = key and enter the desired trigger point, e.g. 2805, in the same format previously selected for the display. The trigger word is displayed for verification.



2805

To enter a delay that will position the start or stop of data collection a specific number of clock pulses from the trigger word, press the Delay = key and enter the number of desired clock pulses. The delay count is entered and displayed in decimal format. Delays of up to 65 535 clock pulses after the trigger point may be entered and used to either start or end data collection.

The trace specification is now complete and the 1602A is ready to capture data. Pressing the Trace key instructs the Analyzer to start looking for the trigger word. Once the trigger word is recognized, the Analyzer captures and stores 64 words in memory as defined by the preset trace specifications.



0 2805 2806

Two words are normally displayed in the viewing window. The number at the far left (0 in this example) is the memory location of the word 2805₁₆. The word on the far right is in the next higher location of the Analyzer's memory.

The data in the Analyzer's memory may be viewed on the display using the four keys in the display block. The Prior Word and Next Word keys permit you to view the memory contents one word at a time, or if you hold a key, the memory contents will sequence rapidly through the display. The Word Number = key allows you to quickly address any memory location and the At Trigger Word key automatically restores the display to the trigger point.

Measurement Flexibility

This Analyzer, with all its operating simplicity, has the power required to capture more than basic data lists. For example, to determine if a data line is stuck in one state, a Trace Continuous mode permits the suspected line to be monitored for activity. The mode is entered by pressing TRACE followed by C and may be used with any number base.

To capture data on the n^{th} pass of a loop, a Delay By Events mode is available. Delay By Events is entered by pressing in sequence Delay =, E, and then entering in decimal format the desired number of events to 65 535. The display then shows that the Analyzer is set to Delay By Events with an E, and also the selected number of events, 352. When Trace is pressed the 1602A will count the selected number of Events (trigger points) before capturing data.

For viewing consecutive occurrences at specific points, such as data being sent to a peripheral, a Trace Events Mode is provided. This mode is entered by pressing Trace followed by E which directs the 1602A to capture only the data that is described by the current trace specification trigger word plus delay.

When additional qualification is needed for data collection, such as restricting the data to only reads, writes, or outputs, the rear panel trigger and clock qualifiers are available. These inputs are compatible with the HP Model 10250A TTL trigger probe allowing expansion to four qualifier inputs.

Once a functional fault is located in execution of the program, another form of analysis instrument, usually an oscilloscope, is frequently desired to pinpoint the problem. The Analyzer's trigger output is stable with the system clock which allows an oscilloscope to be used for critical timing measurements.

A Trace Point Output is available for generating interrupt signals or for added "clock stopper" circuits in other parts of the system un-

der test. The rear panel outputs can also be used to cascade 1602A's or other analyzers.

And, for those occasions where the data being gathered are mixtures of information from buses and control lines, a mixed mode of binary and either hex, decimal, or octal bases can be easily entered with a few keystrokes. Pressing Word Width = 16 and Hex 8 gives the display shown.



16 862 8616

The resulting trace then displays the captured data in the format most convenient for analysis.



0 00101000 05

The Analyzer also interacts with message codes which assist the operator in gathering and sorting data. The definitions of these message codes are included inside the storage compartment top cover for easy reference.

For increased confidence of the Analyzer's operation, it performs a self-test during turn-on and indicates the results on the display. In addition, there is a multilevel diagnostic software which allows the Analyzer to identify virtually any internal fault.

Automatic Testing

In addition to stand-alone operation the Analyzer can be configured for use with the Hewlett-Packard Interface Bus (IEEE 488) family of interactive instruments. An optional HP-IB interface is available which when combined with a computing controller and suitable stimulus allows the data captured by the programmable 1602A to be transferred to the controller for analysis, providing fast, easily repeatable checkout and troubleshooting in production and service environments. Now, the engineer who designs a system can establish proper vs improper operating characteristics and provide an automatic test sequence which will functionally check the system. By developing the tests in an HP-IB configuration, he can print out a complete data record for each test, greatly simplifying documentation of test procedures.

The greatest benefit of automated testing is that each instrument is tested identically; a QA inspector can functionally test the system with the same parameters used in final test. System failures that occur during testing can be readily defined and documented, and since they are stored in an automated test routine, the failure test conditions can be duplicated at will. Libraries of faults can be rapidly generated using these automated test procedures, with each fault documented and stored in a data cartridge file for use in automated debugging in production or field service.

Programming

A learn mode feature provides an easy way for a designer to program the Analyzer with an HP Model 9825A Computing Controller without using the formal HPL language. A few special function keys are all that is needed for most test programs, and the procedure for using them is also easy. Just make the measurement once manually using the 1602A and then press LEARN on the Computing Controller. The system will then become conversational and ask for the test number, number of words of 1602A memory to be compared, desired measurement time limit, and which test to go to if the present test passes or fails. The Computing Controller then automatically reads the Analyzer's keyboard and memory and transfers this data to its cassette. The first test of the "test procedure" is now completed and documented. A complete test procedure can be rapidly generated and documented by using this method. To use the test procedure, simply connect to the system or device under test and press the special function "Run" key on the Computing Controller. Your "Automated" test system then sets up the first test in the procedure, compares the data collected to the reference data stored on the cassette, and automatically branches (based on the data comparison) to either a new test or a comment. This means that all your devices can be functionally tested in minutes, automatically, with identical procedures eliminating variations due to differences between operators.



Debugging HP-IB (IEEE 488) Systems

Hewlett-Packard's Models 10050A and 10051A HP-IB Adapter and Test Probe offer a convenient method of Monitoring HP-IB (IEEE 488) lines with a 1602A Logic State Analyzer. These accessories connect directly to the interface bus, do not interfere with normal system operation, and are capable of monitoring activity at full operating speeds. The 1602A's mixed display mode allows decoding of bus information to match the bus format of eight data, and eight control and handshake lines. With a few keystrokes, the display may be configured with eight lines in binary and the remaining eight in either hexadecimal, octal, or decimal format.



HP-IB Adapter

For basic monitoring of an HP-IB system, the Model 10050A Adapter is quickly connected to the 1602A probe and HP-IB piggy-back connector. There are no time consuming problems of connecting individual probe leads to an HP-IB connector.

HP-IB Test Probe

More complete tests of an HP-IB system can be performed using Model 10051A Test Probe in conjunction with the 10050A Adapter. Connection to the system under test is accomplished by plugging in the test probe, adapter, and connecting to the HP-IB connector.

With the 10051A, you automatically check for protocol violations on three handshake wires. If any of the six legal states occur out of sequence or one of the two illegal states is accessed, the LED on the probe flashes to indicate a possible problem and also supplies a pulse for triggering the 1602A or external instrumentation so that a problem can be quickly located. The timing diagram shows the normal sequence on the three handshake lines.

SEQUENTIAL REQUIREMENTS OF THE THREE WIRE TRANSFER

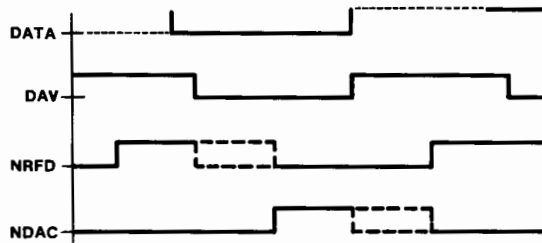

A Clock Qualifier switch allows selection of Commands, Data, or Both to control the type of bus activity that is loaded into the 1602A's memory. A Clock Source switch allows you to strobe data into the 1602A on the positive edge of NDAC, negative edge of DAV, completion of a parallel poll, or with a manual pushbutton. By selecting Parallel Poll as a clock the 1602A monitors DIO lines to check device status when a parallel poll is conducted. If there are no handshake operations being conducted, the Manual pushbutton allows you to clock the current bus state into the 1602A.

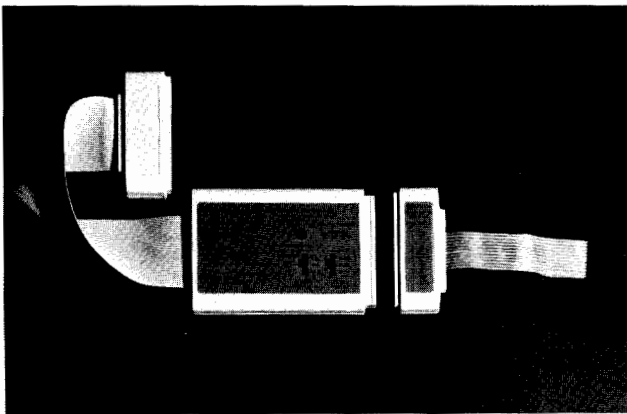

1602A Specifications

Probe Inputs

Repetition rates: to 10 MHz.

Input load: one low power Schottky gate ($<400 \mu\text{A}$ source).

Input threshold: TTL, fixed at $\approx 1.5 \text{ V}$.

Max input: $<+5.5 \text{ V}$.

Min Input

Level: $>-0.5 \text{ V}$.

Swing: from $\leq +0.4 \text{ V}$ (low) to $\geq +2.4 \text{ V}$ (high).

Clock pulse width: $\geq 25 \text{ ns}$ at threshold.

Data setup time: time data must be present prior to a clock transition, 35 ns at threshold.

Hold time: time data must be present after a clock transition, zero.

Trigger and Clock Qualifier Inputs (Rear Panel)

Input load: 8 mA max source.

Max input: $<+5.5 \text{ V}$.

Min Input

Level: $>-0.5 \text{ V}$.

Swing: from $\leq +0.4 \text{ V}$ (low) to $\geq +2.5 \text{ V}$ (high).

Setup time: time data must be present prior to a clock transition, 40 ns with 10250A probe, 10 ns without probe.

Hold time: time data must be present after a clock transition, 15 ns with 10250A probe, 30 ns without probe.

Trigger and Trace Point Outputs

High: $\geq 2 \text{ V}$ into 50Ω .

Low: $\leq 0.4 \text{ V}$ into 50Ω .

Pulse Duration (width)

Trigger: high for \approx one clock period.

Trace point: sets low when Trace key is pressed, returns high when the Trace Specification is met.

Delay from input clock: $<150 \text{ ns}$.

General

Power: 100, 120, 220, and 240 Vac; $-10\% +5\%$; 48 to 66 Hz; 50 VA max.

Size: 107 H x 275 W x 421 mm D ($4\frac{7}{32}'' \times 10\frac{13}{16}'' \times 16\frac{9}{16}''$).

Operating Environment

Temperature: 0°C to $+55^\circ\text{C}$ ($+32^\circ\text{F}$ to $+132^\circ\text{F}$).

Humidity: up to 95% relative humidity at $+40^\circ\text{C}$ ($+104^\circ\text{F}$).

Altitude: to 4600 m (15 000 ft).

Vibration: vibrated in three planes for 15 min. each with 0.38 mm (0.015 in.) excursions, 10 to 55 Hz.

Weight: net, 4.5 kg (10 lb); shipping, 5.9 kg (13 lb).

Accessories supplied: one external probe pod, one connector with individual clock, ground, and data probe leads with tips, three display labels (HP P/N 01602-94302), one 2.3 m (7.5 ft) power cord, one Operating and Service Manual.

Probe interface: the probe interface is a standard, two row, edge connector which may be easily added to instruments during development, providing easily accessed test points for production and field service requirements.

Options

001: HP-IB Interface

Operating instruction labels are available in five additional languages. On initial order of a 1602A, one special language label may be ordered as an option. Additional labels must be ordered by part number.

400: French (HP P/N 7120-6467)

401: Spanish (HP P/N 7120-6468)

402: Italian (HP P/N 7120-6469)

403: German (HP P/N 7120-6960)

404: Japanese (HP P/N 7120-6697)

Accessories

10250A TTL trigger probe: Model 10250A Trigger Probe offers a convenient method of expanding the qualification capabilities of the 1602A. With the 10250A connected to the 1602A rear panel Trigger or Clock Qualifier inputs, you have an additional four bits of qualification. The four inputs may be switched to HI, LO, or OFF (don't care) for selection of the desired qualification pattern. Power for the trigger probe is obtained from the circuit under test.

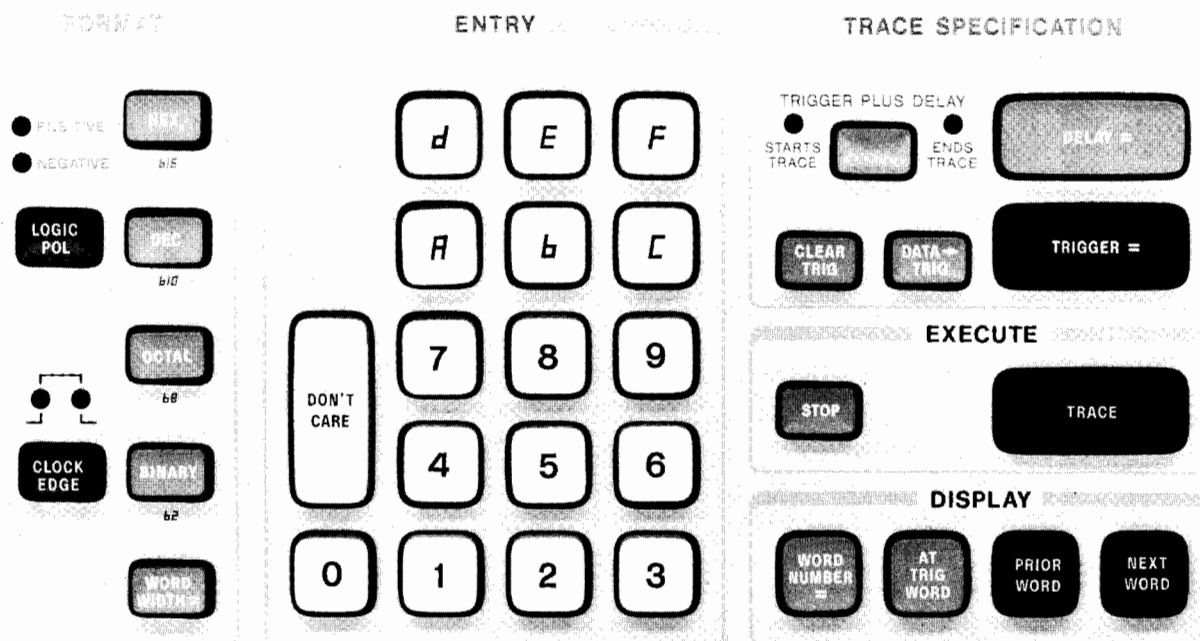

The keyboard of the Model 1602A Logic State Analyzer is easy to use with its key-per-function layout. Entry of triggering and display conditions is a series of self-explanatory keystrokes with entries displayed as they are entered, for a quick check of input accuracy.

Probe Interfacing

- 01602-68701:** connector with leads (without slip-on probe tips).
- 01602-68702:** connector kit (without leads).
- 10230-68702:** package of ten slip-on probe tips.

The probe interface is a standard two row, edge connector which may be easily added to instruments during development, for easily accessed test points in production and field service requirements.

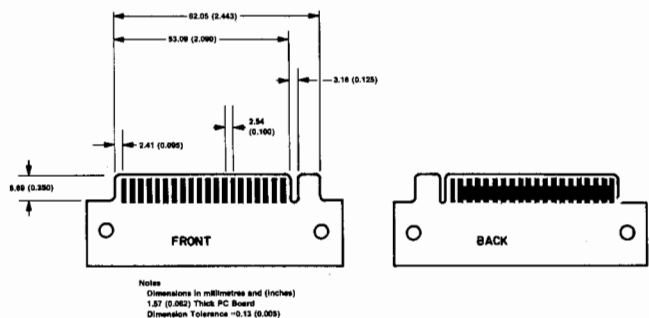

HP-IB Controllers and Accessories

The following computing controller and accessories combined with a 1602A Option 001 provide a complete HP-IB Test System.

Model 9825A Computing Controller: Opt 002 with a 23 000 byte memory is recommended for maximum flexibility. Accessories required are Model 98210A String and Advanced Program ROM, Model 98213A General and Extended I/O ROM, and a Model 98034A HP-IB Interface Card.

Software: the Model 10060A Automatic Logic State Analysis Application Program for the 9825A controller is available and virtually eliminates the need to learn controller or HP-IB language.

10050A / 10051A Specifications

Specifications apply with the 10050A/10051A connected to the 1602A.

Adapter, 10050A: when used as passive connection to the 1602A, loads each HP-IB signal line with one Schottky TTL gate (<400 μ A source) except DAV which is loaded with two low power Schottky TTL gates (<800 μ A source).

Test Probe, 10051A

Input Load: one low power Schottky TTL gate (<400 μ A source) on each HP-IB signal line.

Input threshold: TTL fixed at ≈ 1.5 V except DAV, NRFD, NDAC, ATN, EOI which are buffered with low power Schottky TTL hysteresis gates (positive going threshold ≈ 1.7 V, negative going threshold ≈ 0.9 V).

Max input: < ± 5.5 V.

Min input: > -0.5 V.

Differential signal delay: signals on the ATN and EOI lines are delayed approx 30 ns more than DIO 1-8, SRQ, IFC, REN which are applied to the 1602A data inputs without buffering.

Setup time: data must be present 35 ns prior to a clock transition.

Hold time: data must remain stable 50 ns after a clock transition.

Ordering Information

	Price
1602A Logic State Analyzer	\$2200
Opt 001: HP-IB Interface	add \$340
10250A TTL Trigger Probe	\$125
10050A HP-IB Adapter	\$35
10051A HP-IB Test Probe (includes 10050A)	\$185
10060A Automatic Logic State Analysis Applications Program for 9825A	\$58
01602-68701 Connector with leads (without slip-on probe tips)	\$80
01602-68702 Connector Kit (without leads)	\$49
10230-68702 Slip-on probe tips (10)	\$22.50

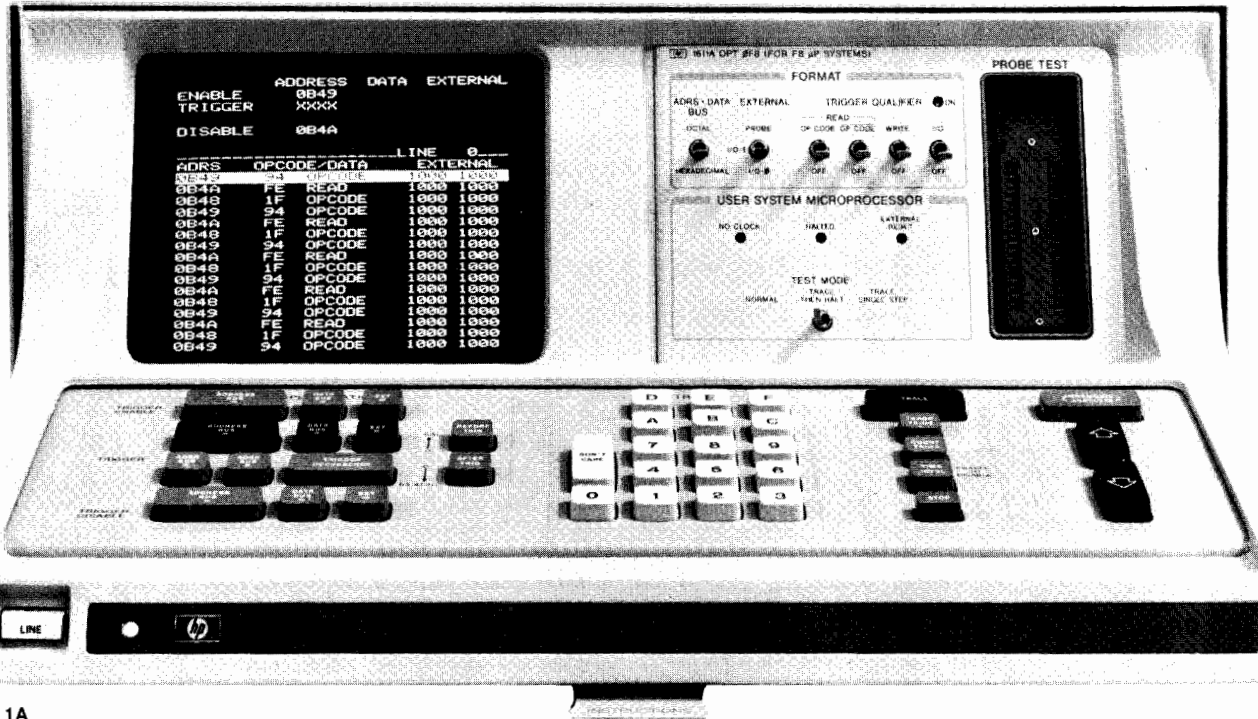

1611A

1611A Description

Hewlett-Packard's Model 1611A Logic State Analyzer quickly locates those elusive software and hardware problems in microprocessor systems. This stand-alone logic state analyzer saves time in design and troubleshooting for earlier operation, shorter down time for maintenance, and lower development and production costs. There are now nine personality modules available for the 1611A; eight of the personality modules can perform a complete inverse assembly of code from buses of eight major processor families, while the ninth personality module is a general purpose module. Programs are debugged on operating hardware with real-time viewing of the system's actual operation for analysis. Extensive triggering capability allows you to capture 64 pertinent transactions on data and address buses as well as external lines. Model 1611A is passive to the system under test, adding small capacitance and drawing only a small amount of current. Data entry may be hexadecimal or octal base, with binary base for control lines.

The keyboard is divided into four functional areas, data registration, entry, execute, and display. Specific events in program execution can be pinpointed with the ability to trigger on address, data, external signals, or any combination of the three. A direct readout of elapsed time or number of events between specified states, as well as minimum and maximum times or counts, can be obtained. Selective triggering is further refined by range triggering, selective store, sequential triggering and trace triggers. In effect, you "edit" the data, collecting only the transactions needed for analysis. Model 1611A performs a self-test during turn-on and displays the results.

Dedicated Personality Modules

The eight dedicated personality modules reduce setup time as input parameters are already matched to proper trigger levels and clock slopes of the microprocessor. Connection to the system is quick and easy with a "clothespin" clip, or the 40-pin connectors for address and data and eight auxiliary leads with individual miniature probes for related control lines. You can view microprocessor transactions in mnemonic language or absolute code on the 32-bit wide display. Halting or single-stepping the microprocessor is possible with any of the dedicated personality modules.

General Purpose Personality Module

Using the general purpose personality module makes the 1611A a conventional logic state analyzer for microprocessors. All but the device-specific capabilities of the dedicated modules are retained, and you can monitor virtually any microprocessor which has accessible test points. With a display up to 36 bits wide you can observe activity on several buses simultaneously on 8-bit or 16-bit microprocessors. Seven clocks allow multiplexed information to be latched into the 1611A at the appropriate time for display. The listing is displayed in absolute code in hexadecimal or octal for address and data buses, and in same base or binary for the external and auxiliary lines. Connection to the system under test is universal, with two pods, individual leads, and miniature probes for all inputs.

ADDRESS		DATA	EXTERNAL
TRIGGER	000F		
PRE-TRIGR=7			

ADR	OPCODE/DATA	EXTERNAL	
0009	LD C,B	0000	0000
000A	LD L,00	0000	0000
000C	LD H,D	0000	0000
000D	LD A,(HL)	0000	0000
0400	00 READ	0000	0000
000E	LD H,B	0000	0000
000F	LD (HL),A	0000	0000
3400	00 WRITE	0000	0000
0010	INC L	0000	0000
0011	JP NZ,000C	0000	0000
000C	LD H,D	0000	0000
000D	LD A,(HL)	0000	0000
0401	31 READ	0000	0000
000E	LD H,B	0000	0000
000F	LD (HL),A	0000	0000
3401	31 WRITE	0000	0000

Inverse assembly of the data on the data buses is possible with the eight dedicated personality modules. This mnemonic display is in the familiar assembler format for easy interpretation.



Model 1611A (Cont.)

ENABLE	ADDRESS	DATA	EXTERNAL
TRIGGER	29C3		
	XXXX		
DISABLE	29B6		

ADRS	OPCODE/DATA	EXTERNAL

TIME =	98 MICROSECONDS
MAX =	280 MICROSECONDS
MIN =	90 MICROSECONDS

The time interval mode and the ability to select enable and disable trigger conditions allows direct measurements of execution time in loops, subroutines, and responses to interrupts. The 1611A can record the time for one measurement or provide the minimum and maximum values along with the last measurement from repeated measurements.

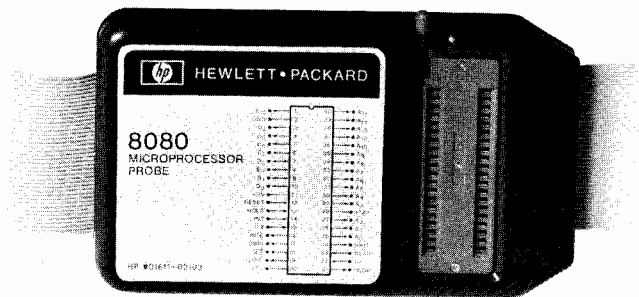

Connection with dedicated personality probes is with a 40-pin dual in-line package clip or the microprocessor may be relocated to the probe body and the probe connected to the system with a 40-pin connector.

Configuration

The flexibility and convenience of Model 1611A are a function of the nine personality modules. On initial order, the 1611A is fitted with the module of your choice. Subsequently, to change the configuration, a new personality module can be installed on site in about 15 minutes. Each module consists of two or three printed circuit boards, an insert for the front panel, and the accompanying microprocessor probe. Dedicated personality modules are available for eight microprocessor types: 6800, 6809, 8080, F8, Z80, 6502, 1802, and 8085. The general purpose personality module features flexibility, and can be used to troubleshoot most microprocessors manufactured now or in the foreseeable future.

Option 001 (General Purpose Personality Module)

Note: Model 10264A personality module may be ordered separately for installation in a 1611A to provide Option 001 capability.

Inputs

Input current: 200 μ A, logic 0 (low); \approx 20 μ A logic 1 (high).

Threshold: 2 V min, logic 1 (high); 0.7 V max, logic 0 (low). All inputs have hysteresis.

Input capacitance: \approx 20 pF.

Clock

Clock rate: dc to 2.8 MHz max (2.2 MHz max if installed in a 1611A with serial number prefix of 1723A or below). Min pulse width is 30 ns. No clock should occur until at least 100 ns after the master clock. The NO CLOCK indicator lights if the period between clocks exceeds 4 ms.

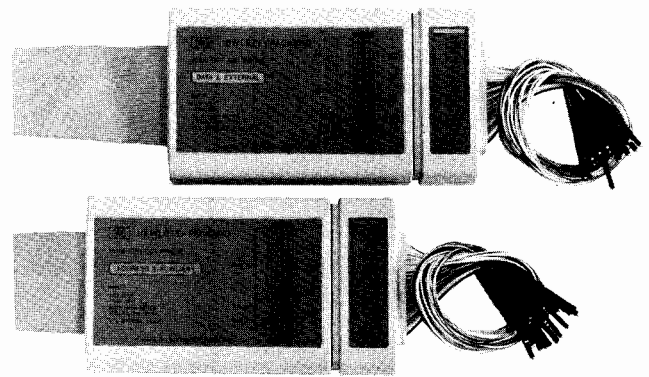

External probes used with the general purpose personality module can obtain signals from up to 36 test points, whether the lines are dedicated or multiplexed.

Setup and Hold Times

Setup time: 80 ns relative to specified clock edge.

Hold time: zero.

Option A68 (6800 Microprocessors)

Note: Model 10257B personality module may be ordered separately for installation in a 1611A to provide Opt A68 capability.

Microprocessor Compatibility

Motorola: 6800, 68A00, 68B00, 6802.

AMI: 6800.

Note: The 1611A Opt A68 is compatible with any microprocessor that meets specifications of the Motorola 6800.

Clock and Data Inputs

Clock rate: 70 kHz to 2.0 MHz; (70 kHz to 1.66 MHz with 10257B installed in 1611A with serial number prefix below 1723A).

Input Loading

A₀-A₁₅, R/W, VMA: \approx 1 M Ω shunted by \approx 40 pF, including capacitance of 30.4 cm (12") cable; \approx 30 pF with 7.6 cm (3") cable.

D₀-D₇, BA, BS: 20 μ A max with $V_{in} = 2.7$ V; -0.2 mA max with $V_{in} = 0.4$ V.

HALT: 120 μ A max with $V_{in} = 2.7$ V; -0.2 mA max with $V_{in} = 0.4$ V.

Φ 2: 0.2 mA max with $V_{in} = 5$ V; -0.4 mA max with $V_{in} = 0.4$ V.

Threshold: 2.4 V to 5.5 V, logic 1 (high); -0.8 V to 0.8 V, logic 0 (low).

Halt output: TTL open-collector compatible output capable of sinking at least 8 mA when active.

Option A09 (6809 Microprocessors)

Note: Model 10266A personality module may be ordered separately for installation in a 1611A to provide Opt A09 capability.

Microprocessor Compatibility

Motorola: MC6809, MC6809E, MC68A09, MC68A09E, MC68B09, MC68B09E.

Note: The 1611A Opt A09 is compatible with any microprocessor that meets specifications of the Motorola 6809.

Clock and Data Inputs

Clock rate: 80 kHz to 2 MHz (70 kHz to 1.66 MHz with 10266A installed in 1611A with serial number prefix below 1723A).

Input loading

A₀-A₁₅, R/W: \approx 1 M Ω shunted by \approx 40 pF including capacitance of 30.4 cm (12") cable; \approx 30 pF with 7.6 cm (3") cable.

D₀-D₇, BA, BS: 20 μ A max with $V_{in} = 2.7$ V; -0.2 mA max with $V_{in} = 0.4$ V.

HALT: 120 μ A max with $V_{in} = 2.7$ V; -0.2 mA max with $V_{in} = 0.4$ V.

E-Clock: 0.2 mA max with $V_{in} = 5$ V; -0.4 mA max with $V_{in} = 0.4$ V.

Threshold: 2.4 V to 5.5 V, logic 1 (high); -0.8 V to 0.8 V, logic 0 (low).

Option A80 (8080 Microprocessors)

Note: Model 10258B personality module may be ordered separately for installation in a 1611A to provide Opt A80 capability.

Microprocessor Compatibility

Intel: 8080, 8080A, 8080A-1, 8080A-2.

AMD: 9080A, 9080A-1, 9080A-2, 9080A-4.

NEC: μ PD8080, μ PD8080A-E.

Ti: TMS8080, TMS8080A.

National: INS8080A.

Note: The 1611A Opt A80 is compatible with any microprocessor that meets specifications of the Intel 8080A.

Clock (Φ 2 only)

Repetition rate: 300 kHz to 4 MHz.

Width: 75 ns min for either high or low state.

Input resistance: \approx 12 k Ω .

Input capacitance: \approx 25 pF, includes capacitance of 30.5 cm (12") cable, \approx 15 pF with 7.6 cm (3") cable.

Threshold: 9 to 13 V, logic 1 (high); -1 to 0.8 V, logic 0 (low).

Data, Address, Wait, Ready, HLDA, INTE, SYNC

Input resistance: \approx 1 M Ω .

Input capacitance: \approx 25 pF, includes capacitance of 30.5 cm (12") cable, \approx 15 pF with 7.6 cm (3") cable.

Threshold: 3 V to 6 V, logic 1 (high); -1 to 0.8 V, logic 0 (low).

Ready output: TTL open-collector compatible output capable of sinking at least 8 mA when active.

Option A85 (8085 Microprocessors)

Note: Model 10263A personality module may be ordered separately for installation in a 1611A to provide Option A85 capability.

Microprocessor Compatibility

Intel: 8085, 8085A, 8085A-2.

AMD: AM9085.

Siemens: 8085.

NEC: μ PD8085.

Note: The 1611A Opt A85 is compatible with any microprocessor that meets specifications of the Intel 8085.

Clock, Data, Address, Status, and Control Inputs

Clock rate: 300 kHz to 5 MHz.

Threshold: 2 V to 5.5 V, logic 1 (high); -0.5 V to 0.8 V, logic 0 (low).

Input Current

Clock and Control: \approx 50 μ A max with $V_{in} = 2.7$ V; -0.4 mA max with $V_{in} = 0.5$ V.

Data, Address, and Status: \approx 20 μ A max with $V_{in} = 2.7$ V; -0.2 mA max with $V_{in} = 0.4$ V.

Input capacitance: \approx 25 pF including capacitance of 30.5 cm (12") cable; \approx 15 pF with 7.6 cm (3") cable.

Ready output: TTL compatible open-collector output capable of sinking at least 8 mA when active.

Option 0F8 (F8 Microprocessors)

Note: Model 10259A personality module may be ordered separately for installation in a 1611A to provide Option 0F8 capability.

Microprocessor Compatibility

Fairchild: F8 (3850).

Mostek: F8 (3850).

Note: The 1611A Opt 0F8 is compatible with any microprocessor that meets specifications of the Fairchild F8.

Clock and Write

Clock rate: 100 kHz to 2 MHz.

Width: 180 ns min for either high or low state.

Input current: \approx 50 μ A, logic 0 (low) and logic 1 (high).

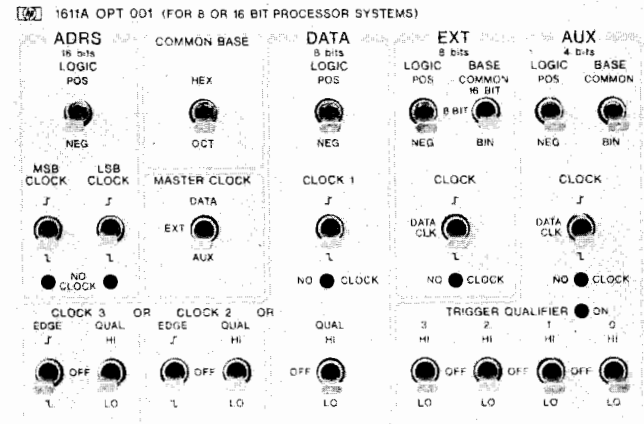

Opt 001 General Purpose Personality Module

Input capacitance: \approx 25 pF, includes capacitance of 30.4 cm (12") cable; \approx 15 pF with 7.6 cm (3") cable.

Threshold: 2.4 V to 5.5 V, logic 1 (high); -0.8 to 0.8 V, logic 0 (low).

Write period: either 4 or 6 times the clock period.

Write pulse width: max = clock period, min = clock period - 100 ns.

ROMC

Input current: \approx 22 μ A, logic 0 (low); \approx 40 μ A, logic 1 (high).

Input capacitance: \approx 25 pF, includes capacitance of 30.4 cm (12") cable; \approx 15 pF with 7.6 cm (3") cable.

Threshold: 2 V min, logic 1 (high); 0.7 V max, logic 0 (low).

Data, I/O0, I/O1, EXT RES

Input current: \approx 200 μ A, logic 0 (low); \approx 20 μ A, logic 1 (high).

Input capacitance: \approx 25 pF, includes capacitance of 30.4 cm (12") cable; \approx 15 pF with 7.6 cm (3") cable.

Threshold: 2 V min, logic 1 (high); 0.7 V max, logic 0 (low).

Halting

The F8 CPU must be placed in the 1611A Probe socket to halt or single-step the F8 microprocessor.

Option Z80 (Z80 Microprocessors)

Note: Model 10260A personality module may be ordered separately for installation in a 1611A to provide Option Z80 capability.

Microprocessor Compatibility

Zilog: Z80, Z80A.

Mostek: 3880 (Z80), 3880N-4 (Z80A).

Note: The 1611A Opt Z80 is compatible with any microprocessor that meets specifications of the Zilog Z80.

Clock, Data, Address, and Control Inputs

Clock rate: 500 kHz to 4 MHz.

Input current: \approx 200 μ A, logic 0 (low); \approx 20 μ A, logic 1 (high).

Input capacitance: \approx 25 pF, includes capacitance of 30.4 cm (12") cable; \approx 15 pF with 7.6 cm (3") cable.

Threshold: 2 V min, logic 1 (high); 0.7 V max, logic 0 (low).

Wait output: TTL open-collector compatible output capable of sinking at least 8 mA when active.

Option A65 (6502 Microprocessors)

Note: Model 10261A personality module may be ordered separately for installation in a 1611A to provide Option A65 capability.

Microprocessor Compatibility

MOS Technology: MCS6502, MCS6502A.

Rockwell: R6502, R6502A, R6512, R6512A.

Synertek: SY6502.

Note: The 1611A Opt A65 is compatible with any microprocessor that meets specifications of the MOS Technology MCS6502.

LOGIC ANALYZERS

Model 1611A (Cont.)

1611A OPT A80 (FOR 8080 μ P SYSTEMS)

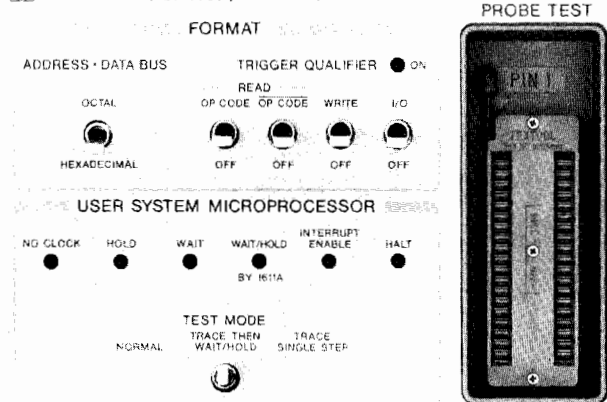

Opt A80 8080 μ P Personality Module

Clock and Data Inputs

Clock rate: 70 kHz to 2 MHz.

Input Loading

AO-A15, R/W, Sync: ≈ 1 M Ω shunted by ≈ 40 pF, including capacitance of 30.4 cm (12") connecting cable, ≈ 30 pF with 2.6 cm (3") cable.

DO - D7: 20 μ A max with $V_{in} = 2.7$ V; -0.2 mA max with $V_{in} = 0.4$ V.

Rdy: 120 μ A max with $V_{in} = 2.7$ V; -0.2 mA max with $V_{in} = -0.4$ V.

$\Phi 2$: 0.2 mA max with $V_{in} = 5$ V; -0.4 mA max with $V_{in} = 0.4$ V.

Threshold: 2.4 to 5.5 V, logic 1 (high); -0.8 V to 0.8 V logic 0 (low).

RDY output: TTL compatible open collector output capable of sinking at least 8 mA when active.

Option A18 (1802 Microprocessors)

Note: Model 10262A personality module may be ordered separately for installation in a 1611A to provide Option A18 capability.

Microprocessor Compatibility

RCA[®]: CDP1802D, CDP1802CD. Example of RCA acceptable operating conditions at $+25^{\circ}\text{C}$ with a shunt capacitance of 50 pF are:

V_{cc}	V_{dd}	CLOCK SPEED
5	5	2 MHz
5	10	4 MHz
10	10	5 MHz

Note: The 1611A Opt A18 is compatible with any microprocessor that is functionally identical to the RCA 1802. Microprocessor operating conditions (clock rate, supply voltages and signal timing) must be compatible with the 10262A setup and hold specifications.

®Registered Trade Mark RCA Corp.

Clock and Data Inputs

Input loading, MA 0—MA 7, Bus 0—Bus 7, TPA, TPB, XTAL, SCO, SC1, MRD, MWR, NO, N1, N2, WAIT, CLEAR: ≈ 32 k Ω shunted by ≈ 25 pF including the capacitance of a 30.5 cm (12") cable or ≈ 15 pF with a 7.6 cm (3") cable.

Threshold: automatically adjusted internally to $\approx V_{DD}/2$.

Wait output: series current limit. Open collector output series with current limited to 10 mA.

Waiting: with the Test Mode Switch in TRACE THEN WAIT or TRACE SINGLE STEP with the CPU in the 1611A probe socket, the 1611A will cause the CPU to wait. If the CPU is not in the probe socket, waiting cannot be guaranteed.

1611A Specifications

General

External Probe Inputs

Current: ≈ 50 μ A logic 0 or logic 1

Capacitance: ≈ 25 pF at probe tip.

Threshold: 2.4 V to 5.5 V logic 1 (high); -0.8 to 0.8 V logic 0 (low).

Hold time: zero, relative to appropriate strobe edge.

Outputs

Low: < 0.4 V into 50 Ω .

High: > 2.0 V into 50 Ω (nominally 3.9 V into an open circuit).

Trigger: duration ≈ 75 ns in RZ format; delay ≈ 350 to 400 ns after the appropriate strobe edge during the cycle that defines a valid trigger.

Trace Point (\lceil): provides a positive edge ≈ 350 to 400 ns after the appropriate strobe edge during the cycle that defines the specific valid trigger to be displayed on the 1611A. If the 1611A Delay is set so that the trigger word is not displayed, Trace Point output occurs for the cycle that defines the valid word immediately preceding the first displayed word.

Trace Point (\lfloor): complement of Trace Point (\lceil).

Memory depth: 64 data transactions; 16 transactions are displayed at one time, roll keys permit viewing of all 64 transactions.

Time interval: accuracy, $0.1\% \pm 1$ μ s. Max time, $(2^{24}-1)$ μ s (16.7 s).

Events count: $2^{24}-1$ events (16.7 million) max.

Logic probe output power: 5 V dc at 0.1 A max.

Power: 100, 120, 220, 240 V ac; -10% $+5\%$; 48 to 440 Hz; 120 VA max.

Size: 189 H x 426 W x 572 mm D ($7 \frac{7}{16}$ " x $16 \frac{3}{4}$ " x $22 \frac{1}{2}$ ").

Operating environment: temperature, 0°C to $+55^{\circ}\text{C}$ ($+32^{\circ}\text{F}$ to 132°F); humidity, to 95% relative humidity at $+40^{\circ}\text{C}$ ($+104^{\circ}\text{F}$); altitude to 4600 m (15 000 ft); vibrated in three planes for 15 min. each with 0.38 mm (0.015 in.) excursions, 10 to 55 Hz.

Weight: net, 15 kg (33 lb); shipping, 19.5 kg (43 lb).

Accessories Supplied

With 1611A: external 8-bit probe; one 2.3 m (7.5 ft) power cord; and one Operating and Service Manual.

With Dedicated Module: one 40-pin clip with 30.5 cm (12") cable; one 40-pin male socket with 30.5 cm (12") cable; and one 40-pin male socket with 7.6 cm (3") cable.

With General Purpose Module: two universal probes with individual leads, and miniature probe tips for each input.

Ordering Information

Ordering Information	Price
1611A Opt 001 Logic State Analyzer, General Purpose	\$6800
1611A Opt 002 adds Model 10277D GP Probe Interface; order with 1611A Opt 001 only	add \$475
1611A Opt A68 Logic State Analyzer for 6800 μ P	\$5900
1611A Opt A09 Logic State Analyzer for 6809 μ P	\$6000
1611A Opt A80 Logic State Analyzer for 8080 μ P	\$5900
1611A Opt A85 Logic State Analyzer for 8085 μ P	\$5900
1611A Opt 0F8 Logic State Analyzer for F8 μ P	\$6400
1611A Opt Z80 Logic State Analyzer for Z80 μ P	\$5900
1611A Opt A65 Logic State Analyzer for 6502 μ P	\$6400
1611A Opt A18 Logic State Analyzer for 1802 μ P	\$6400

Personality Modules for Field Installation

10257B for 6800 μ P	\$1400
10258B for 8080 μ P	\$1400
10259A for F8 μ P	\$1900
10260A for Z80 μ P	\$1400
10261A for 6502 μ P	\$1900
10262A for 1802 μ P	\$1900
10263A for 8085 μ P	\$1400
10264A General Purpose	\$2300
10266A for 6809 μ P	\$1500

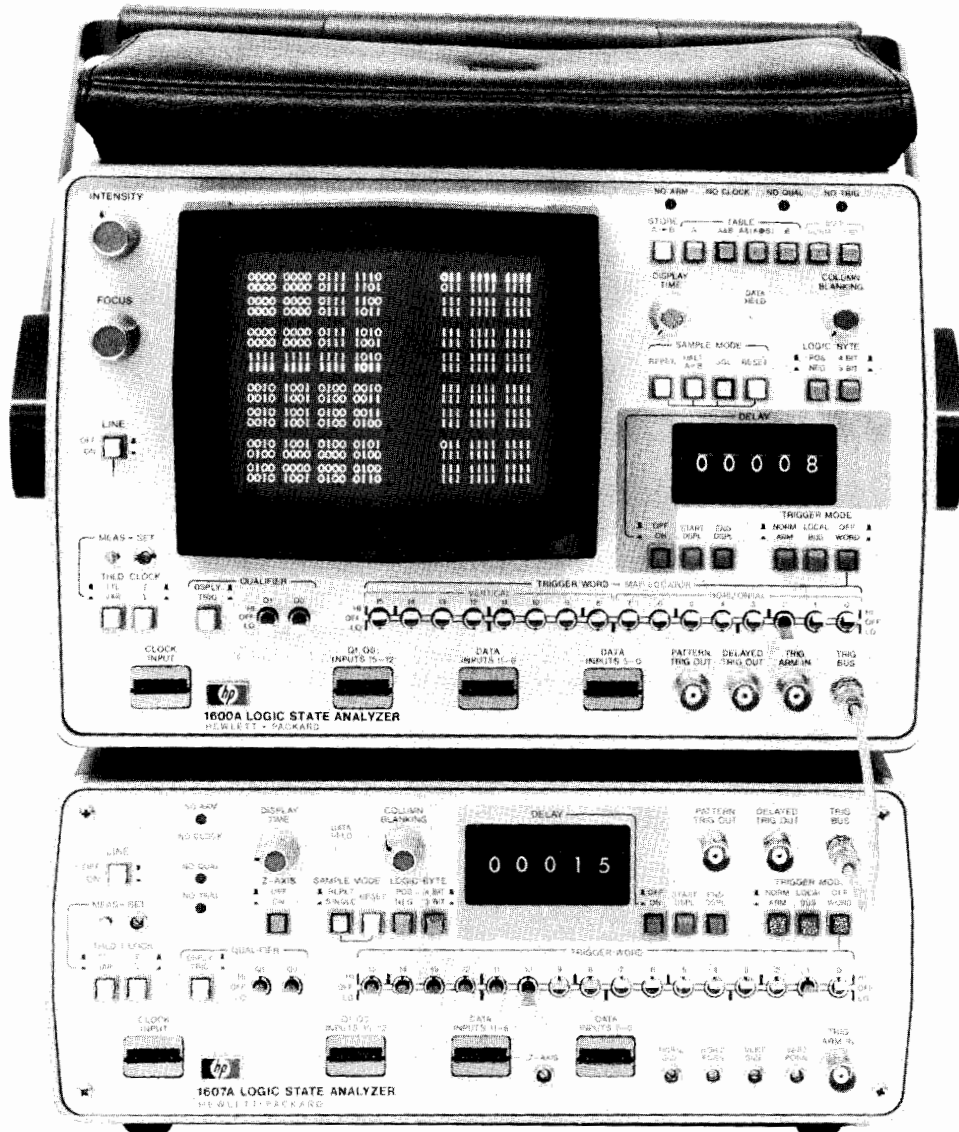

1600S

1600S Description

The 1600S Logic State Analyzer is a versatile, general purpose data domain instrument for use in design and troubleshooting of minicomputer and microprocessor based systems as well as other digital systems. Parallel data is captured at clock speeds to 20 MHz and presented in an easy-to-read one's and zero's display format for fast functional analysis of digital data flow. The ability to capture and display words up to 32-bits wide lets you observe, in real time, microcodes or addresses with resulting data, saving time in system design and development, hardware troubleshooting, software evaluation, and service and maintenance. Convenient and flexible functional analysis is provided by features such as sequential triggering, dual clock, separately configured data tables, display qualification, exclusive OR comparison of Tables A and B, dynamic mapping, and halt when A is not equal to B.

The 1600S consists of a 1600A Logic State Analyzer, a 1607A Logic State Analyzer, a 10236A Trigger Bus Cable, and a 10237A Data Cable. The Trigger Bus Cable logically AND's the trigger registers of both the 1600A and 1607A for a trigger word up to 36 bits wide (four qualifiers not displayed). The Data Cable connects the 1600A Table B memory to the 1607A to enable the display of words up to 32 bits wide, to display two 16-bit data sequences at the same time—such as addresses and instructions, to display 32 consecutive

16-bit words, or for dual clock application. When the full system capabilities are not needed, the 1600A or 1607A may be used separately. The 1600A by itself is a complete logic state analyzer with 16-bit triggering plus two qualifiers, and a 32-bit wide table display as well as dynamic mapping. The 1607A needs only the proper oscilloscope or X-Y display for another complete analyzer, also with 16-bit triggering plus two qualifiers. Both the 1600A and 1607A have a pattern trigger output to trigger an oscilloscope for electrical analysis.

Display Modes

The Map display provides a dynamic overview of a system's operation—a pattern of dots interconnected with vectors that are unique for each area of program implementation. Each dot represents a specific word; its location indicates binary magnitude and its brightness indicates relative frequency of occurrence. The vectors between each dot allow you to observe the sequence of data transactions. The vector gets brighter as it moves toward a new point to show the direction of data flow. With the map you can identify program loops, improper data flow, as well as lost portions of a program. You can also map single-shot events such as those in turn-on sequences.

In the Table display mode you can display up to sixteen 32-bit words which allows you to view address and resultant data flow at the same time. You can look at events leading up to, surrounding, or following the trigger word; and delay up to 99 999 clock cycles beyond

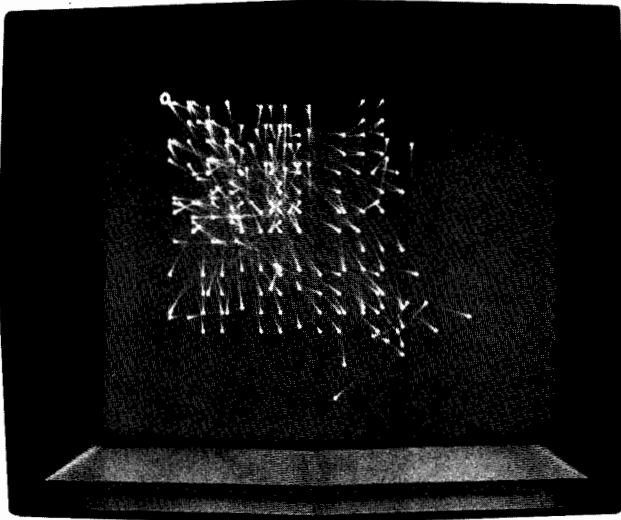

The map display offers an overall view of machine operation, with each dot representing one input word. The real time display allows you to identify program loops, improper data flow, as well as lost portions of a program.

the trigger point to view events anywhere in a program. Two 16-bit by 16-bit table displays, A and B, can be used separately or in various combinations to satisfy a wide variety of applications.

An Exclusive OR mode, $A \oplus B$, makes comparison of Table A and Table B data easy by displaying any differences as intensified one's on Table B. This display mode allows you to quickly compare active data to known stored data, or to compare data from two active systems simultaneously. Comparison data for Table B can be entered from an HP Model 10253A Card Reader. Model 10253A plugs directly into the 1600A Logic State Analyzer and provides a convenient method for performing repetitive tests for incoming inspection, production testing, or any situation requiring frequent comparisons to predetermined data sets.

Another useful mode is the halt when A does not equal B mode ($A \neq B$), which automatically halts and stores the data in the A memory when it does not equal the data in the B memory. Used in conjunction with the $A \oplus B$ mode, this mode frees you from the tedious waiting and watching for intermittent malfunctions.

Display Qualification and Triggering

The 1600S has a total of four qualifier channels which allow only selected data to be captured, greatly expanding the effectiveness of the memory since irrelevant or extraneous data is not strobed into memory. The 1607A pattern trigger output (PTO) can be used as a qualifier input to the 1600A for analysis of multiplexed buses.

You can define two events which must occur in sequence to trigger a data acquisition cycle. The trigger output of the 1607A can be used to arm the 1600A on a selected event, enabling it to look for the second event. Sequential triggering is useful for analyzing branch operations.

Both the 1607A and the 1600A may be operated in the Start Display or End Display modes. In Start Display, the Analyzer triggers on a unique word established by the trigger word switches and displays that trigger word and the fifteen following words as they are clocked in. This is a valuable mode for paging through a system while following an algorithm to trace data flow. End Display triggering captures events leading up to and including the trigger word, providing a "negative time" display. This is extremely helpful for troubleshooting, since you can trigger on an unallowed state or a fault and see where the machine malfunctioned rather than the end results of the error. In addition, delay may be combined with the End Display trigger to capture both positive and negative time data, allowing you to see events before and after the trigger event and reduce analysis time.

When the data you want to see does not immediately follow the de-

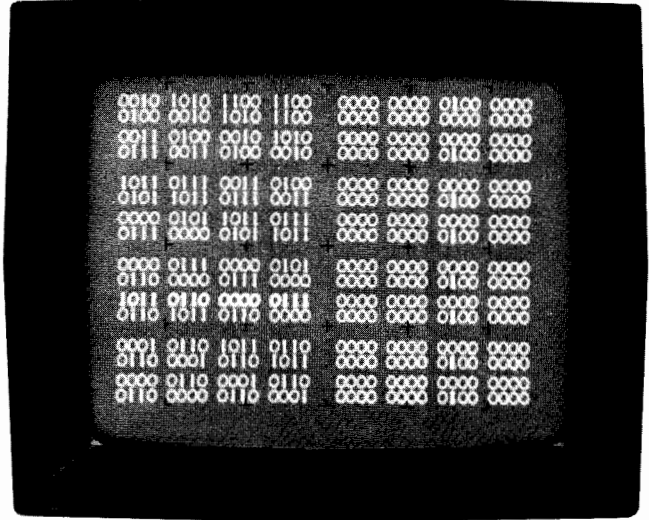

In the Exclusive OR mode, $A \oplus B$, A memory data is displayed on the left while the table on the right displays logic differences between A and B memories. This provides very fast "at-a-glance" comparisons.

sired trigger word, delay can be used to position the sixteen word "window" an exact number of clock pulses from the trigger word. The 1600A and the 1607A each permit selection of up to 99 999 clock cycles of delay.

The 1600A and 1607A have trigger outputs that extend troubleshooting capabilities in digital circuit analysis by windowing oscilloscopes to the proper digital point in time for electrical analysis of circuit operation.

Dual Clock

The 1600A and 1607A may be clocked at different rates which permits you to examine simultaneously up to 16 bits on both sides of an I/O port even though state flow is from two different sources running at different speeds. You can also easily relate bus activity to events occurring elsewhere at different clock rates, such as system peripherals. Dual clock capability can be particularly useful in determining design incompatibilities between hardware and software in micro-computer-controlled systems.

Serial Data Analysis

Model 10254A Serial-to-parallel Converter extends the analytical capabilities of the 1600S to include monitoring serially transmitted data. Data is collected serially at rates to 10 MHz into bidirectional registers and transmitted in parallel to the 1600S by bytes up to 16 bits wide. Sync mode may be a Pattern sync, initiating data collection with the pattern triggers of the analyzer, or Edge sync, using the appropriate edge of the clock for the system under test. You can use the Converter with either Model 1600A or Model 1607A and a display, or two Converters for a display of serial data 32 bits wide. Operating parameters are matched to those of the 1600S, including a zero hold time and adjustable threshold levels. With the 1600S and 10254A in combination, you can observe data transfers at I/O ports, and monitor communication networks, serial processors, and digital filters.

Versatile Miniature Probes

The 1600S acquires data through six, 6-channel high impedance probes. Two separate clock probes allow connection to the desired strobe source. The miniature probe tips are small enough to connect to adjacent pins or can be slipped off the probe wire for direct connection to 0.6 mm (0.025 in.) square pins, IC test clips, Model 10024A IC clip, and wire wrap pins.

Individual probes are connected to each data or clock pod through a quick disconnect ganging-bar which permits hardwired or semipermanent connections to system nodes that do not need to be disturbed when the Logic State Analyzer and its probe pods are removed.

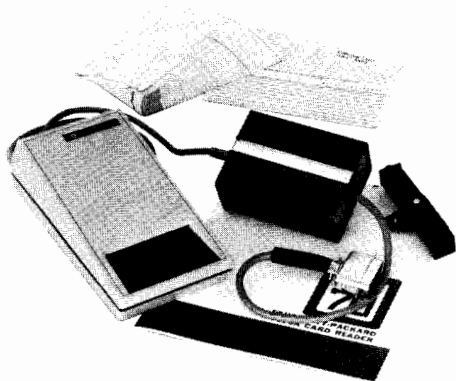

10253A Card Reader

1600S Specifications

Clock and Data Inputs

Repetition rate: 0 to 20 MHz.

Input RC: 40 kΩ ± 3 kΩ shunted by ≤14 pF (at the probe tip).

Input bias current: ≤30 μA.

Input threshold: TTL, fixed at ≈ +1.5 V; variable ±10 Vdc.

Max input: level, -15 to +15 Vdc; swing, 15 V peak from threshold.

Min input: swing, 0.5 V +5% of p-p threshold voltage; clock pulse width, 20 ns at threshold; data pulse width, 25 ns at threshold; data setup time, 20 ns; hold time, zero.

Pattern and Delayed Trigger Outputs

High: ≥2 V into 50Ω (line driver interface).

Low: <0.4 V into 50Ω (line driver interface).

Pulse duration

Delayed trigger: ≈ 25 ns (RZ format) at 1 V level.

Pattern trigger: ≈ 25 ns in RZ format at 1 V level, delay zero or off. With delay on and not zero, pattern trigger output starts on receipt of a pattern trigger signal and ends when delay ends.

Trigger Arm Input

Impedance: 50Ω.

Level: low state, 0 V to <0.4 V; high state, 2 V to <5 V.

Pulse width: 15 ns min at 1.5 V level.

Arming conditions: if the arming pulse positive edge occurs <45 ns after a clock, triggering occurs on the same clock cycle that it is armed. If the arming pulse positive edge occurs >75 ns after a clock, triggering occurs on the next clock cycle.

1607A X-, Y- and Z-axis Outputs

X-axis: <0.6 V to >6 V p-p, ±8 V max into ≥100 kΩ

Y-axis: <0.6 V to >6 V p-p, ±8 V max into ≥100 kΩ.

Z-axis: 0 to 10 V p-p into ≥1 kΩ.

Display interface requirements: the 1607A interfaces with oscilloscope or display with the following input parameters (Not recommended for storage oscilloscopes or displays other than HP Model 1741 Opt 001 Storage Oscilloscope).

X and Y inputs: 0.1 to 1 V/div deflection factors; dc coupled input; and >500 kHz bandwidth.

Z-axis input: dc coupled with positive blanking; full blanking must occur with 10 V input at 10 mA.

General

Display rate: variable from <200 ms to >5 s (1600A), <50 ms to >5 s (1607A).

Power: 100, 120, 220, 240 Vac; -10%, +5%; 48 to 440 Hz; 120 VA max.

Logic probe power: rear panel BNC connector, +5V, 100 mA.

Size

1600A: 197 H x 335 W x 540 mm L with handle (7³/₄" x 13³/₁₆" x 21¹/₄"); 460 mm (18¹/₈") L without handle.

1607A: 121 H x 284 W x 460 mm D (4³/₄" x 11³/₁₆" x 18¹/₈").

Operating environment: temperature, 0 to +55°C (+32°F to +130°F); humidity to 95% relative humidity at +40°C (+104°F); altitude to 4600 m (15 000 ft); vibrated in three planes for 15 minutes each with 0.254 mm (0.010 in.) excursion, 10 to 55 Hz.

Weight

1600S: net, 19.1 kg (42 lb); shipping, 22.7 kg (50 lb).

1600A: net, 12.7 kg (28 lb); shipping, 15.9 kg (35 lb).

1607A: net, 6.4 kg (14 lb); shipping, 8.2 kg (18 lb).

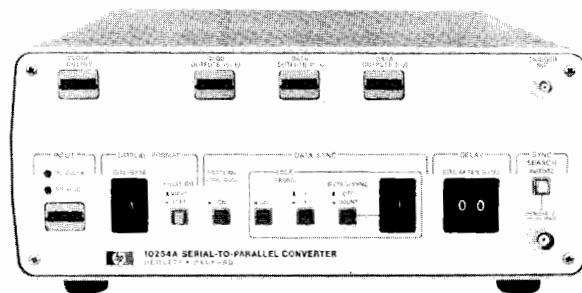

10254A Serial-to-parallel Converter

Accessories Supplied

1600S: six 10231C data probes, two 10230C clock probes, one 10236A Trigger Bus Cable, one 10237A Data Cable, two 2.3 m (7.5 ft) power cords, one accessory case for each analyzer, one 1600A and one 1607A Operating and Service Manual.

1600A or 1607A: three 10231C data probes, one 10230C clock probe, one accessory case, one Operating and Service Manual.

10253A Specifications

Cards: printed cards in format required for 1600A Logic State Analyzer Table B memory; 187 mm (7³/₈") long.

Power: supplied by 1600A.

Weight: net, 1 kg (2.1 lb); shipping, 1.8 kg (4 lb).

Operating environment: same as 1600A except: temperature, +10°C to +40°C (+50°F to +104°F); humidity, to 80% relative humidity at +40°C (+104°F).

Accessories supplied: one drum card, HP P/N 10253-90001; one exerciser card, HP P/N 10253-90002; 100 data cards, HP P/N 9320-3324; one interface box mounting bracket, HP P/N 01120-64701; and one Operating Note.

10254A Specifications

Probe Inputs

Rep rate: ≤10 MHz in Edge Sync, ≤7MHz in Pattern Sync.

Input RC: 40 kΩ ± 3kΩ shunted by ≤14 pF (at the probe tip).

Input threshold: TTL, fixed at 1.5 Vdc; variable ± 10 Vdc selected at the logic state analyzer.

Max input: level, ± 15 Vdc; swing, 15 V peak from threshold.

Min input: pulse width, 40 ns min at threshold; setup time, 50 ns min; hold time, zero.

Operating Modes

Display Format

Bits/byte: 1 to 16 bits (a byte is one line on the display).

First bit, left/right: displays most significant bit left or right.

Data Sync

Pattern: sync on selected unique pattern in the serial data stream.

Edge: sync on input signal on selected edge.

Bytes/sync: select from 1 to 16 bytes of data following each sync.

Delay: 1 to 99 clock pulses after sync signal before data acquisition begins.

Sync search: Initiate pushbutton or a positive-going input pulse starts a new search cycle.

General

Weight: net, 3.2 kg (7 lb.). Shipping, 5 kg (11 lb).

Power: supplied by the 1600A or 1607A.

Size: 12.1 H x 28.4 W x 41.4 cm D (4³/₄ x 11³/₁₆ x 16⁵/₁₆").

Accessories supplied: one Model 10236A Trigger Bus Cable, four interface cables (HP P/N 10254-61601), and one Operating Note.

Ordering Information

1600S 32-channel Logic State Analyzer, includes a 1600A and 1607A

Opt 001: add two 10277C GP Probe Interfaces

1600A 16-channel Logic State Analyzer

1607A 16-channel Logic State Analyzer

10253A Card Reader

10254A Serial-to-parallel Converter

Price

\$8800

add \$800

\$5200

\$3600

\$800

\$1275



LOGIC ANALYZER

ACCESSORIES

Probes and Probe leads

Hewlett-Packard offers a large line of accessories to give you optimal flexibility in integrating the logic analyzers into your digital design and troubleshooting applications.

	Page		Page
Data/Clock Probes	188	Interfaces	190
Microprocessor Probes	188	Cables	192
Trigger Probes	188	Connectors	192
Miniature Probes	188	Testmobiles, Accessories	193
Probe Leads	189		

Logic Analyzer Probes

Most of the probes in this section are supplied with the appropriate logic analyzers. Be sure to check the list of accessories supplied with the logic analyzers you have or will have purchased. The descriptions of these probes are included for your convenience in selecting replacement parts.

Probe Model Number	Logic Analyzer											
	1600S	1600A	1607A	1601A*	1602A	1610A	1610B	1611A	1615A	1620A*	1640B	10254A Converter
10231C Data Probe	6	3	3	2						3		1
10230C Clock Probe	2	1	1	1						1		
10248C Data Probe						4	5		4			
10247A Clock Probe						1						
10250A (TTL) Trigger Probe					1							

*No longer in production

Models 10231C Data Probe and 10230C Clock Probe

These probes are generally used with Model 1600S Logic Analyzer system, which is comprised of Models 1600A and 1607A Logic Analyzers. Each analyzer requires three data probes and one clock probe. These probes are also used with Model 10254A Serial-to-parallel Converter, Model 1620A Pattern Analyzer, and Model 1601A Logic Analyzer. Individual probes are connected to each data or clock pod through a quick-disconnect ganging bar for flexibility in connecting to a system.

Models 10248C Data Probe and 10247A Clock Probe

Models 10248C Data Probes are used with Models 1610A/B and 1615A Logic Analyzers. Each data probe is an 8-bit probe, Model 10247A Clock Probe is a one-bit probe used with the 1610A Logic State Analyzer.

Probe Clip Set (HP P/N 5061-3611)

For convenience in using Model 10248 probes, the Probe Clip Set (HP P/N 5061-3611) permits you to stack the probes without damage. This set is provided on initial order with Models 1610A/B and 1615A Logic Analyzers. The set includes four holders for probes.

Model 1611A Microprocessor Probes

Use the following chart to order replacement microprocessor probes for the various personality modules for Model 1611A Logic State Analyzer; remember that the appropriate microprocessor probe is provided on initial order of personality modules, whether the modules are ordered as options or separate modules.

Micro-Processor Family	1611A Option Number	Personality Modules: Model No.	Module Model Price	Probe Part No.	Probe Price
MOTOROLA 6800	A68	10257B	\$1400	01611-62106	\$450
MOTOROLA 6809	A09	10266A	\$1500	01611-62114	\$450
INTEL 8080A	A80	10258B	\$1400	01611-62107	\$450
FAIRCHILD F8	0F8	10259A	\$1900	01611-62104	\$450
ZILOG Z80	Z80	10260A	\$1400	01611-62105	\$450
ROCKWELL 6502	A65	10261A	\$1900	01611-62108	\$450
RCA 1802	A18	10262A	\$1900	01611-62109	\$450
INTEL 8085	A85	10263A	\$1400	01611-62112	\$450
GENERAL PURPOSE	001	10264A	\$2300	01611-62110	\$875

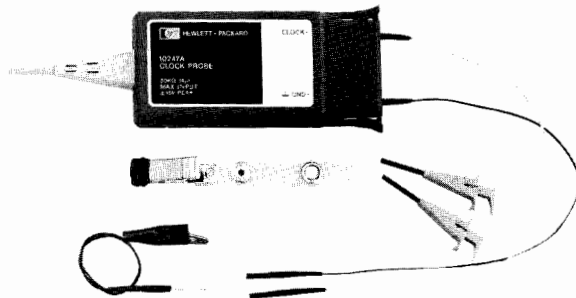

10247A Clock Probe

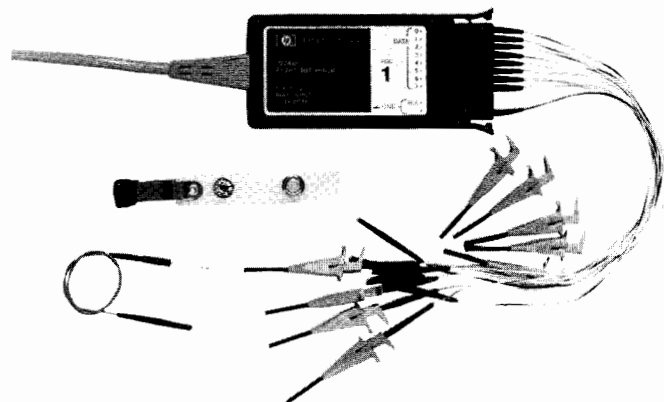

10248C Data Probe

Trigger Probes

Eight-bit External Probe (HP P/N 01611-62101)

The 8-bit external probe (HP P/N 01611-62101) permits connections in a system external to the microprocessor bus for tracing related events or for additional trigger qualifications on Model 1611A Logic Analyzer.

Resistance: 1 MΩ.

Capacitance: 25 pF at probe tip.

Threshold: +2.4 V to +5.5 V, logic 1 (high); -0.8 V to +0.8 V at logic 0 (low).

Setup time: 250 ns prior to falling edge of appropriate strobe.

Hold time: zero (after falling edge of strobe).

Accessories supplied: one ganging bar, eight data leads, one ground lead, and nine probe tips.

Miniature Probes

The Hewlett-Packard series of miniature probes give you easy access to test points in densely populated digital circuits. The basic probe, a small (2.4 mm diameter, 25 mm long) cylinder with a needle-like tip, provides access to test points while reducing the possibility of shorting to adjacent leads. This series of probes consists of 10:1 high impedance divider probes, 1:1 probes for instruments with high impedance inputs, and 1:1 probes for 50 ohm inputs.

For a more complete description of the miniature easy IC probes and accessories, refer to page 224, Oscilloscope Probes and Other Accessories.

Ordering Information

10230C Clock Probe	\$175
10231C Data Probe	\$250
10247A Clock Probe	\$175
10248C Data Probe	\$395
01611-62101 8-bit External Probe	\$270
5061-3611 Probe Clip Kit	\$13

Price

Probe Leads and Probe Lead Kits

Probe leads are provided with every logic analyzer probe. For replacement or special applications, available leads are listed in the next three tables. The last table lists the quick disconnect probe lead kits which are available.

Quick Disconnect Probe Pod Leads

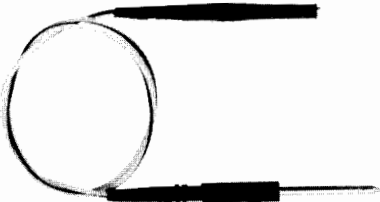

Threaded Probe Pod Leads

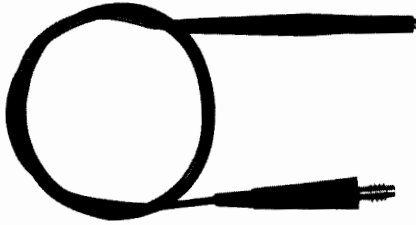

"Single-ended" Probe Pod Leads (Prepared for soldering)

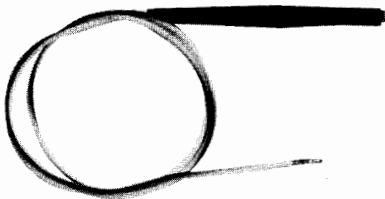

PART NUMBER	LEAD END	LENGTH mm (in.)	COLOR	PRICE
5061-1215	PIN	305 (12)	BLACK	\$3.50
5061-1251	PIN	152 (6)	BLACK	7.25
10231-61624	PIN	610 (24)	BLACK	16.00
10231-61625	ALLIGATOR	305 (12)	BLACK	3.50
5061-1227	PIN	305 (12)	RED	3.50
5061-1216	PIN	305 (12)	YELLOW	3.50
5061-1217	PIN	305 (12)	WHITE/BLACK	3.50
5061-1218	PIN	305 (12)	WHITE/BROWN	3.50
5061-1219	PIN	305 (12)	WHITE/RED	3.50
5061-1220	PIN	305 (12)	WHITE/ORANGE	3.50
5061-1221	PIN	305 (12)	WHITE/YELLOW	4.20
5061-1222	PIN	305 (12)	WHITE/GREEN	3.50
5061-1223	PIN	305 (12)	WHITE/BLUE	3.50
5061-1224	PIN	305 (12)	WHITE/VIOLET	3.50
PART NUMBER	LEAD END	LENGTH mm (in.)	COLOR	PRICE
10231-61606	PIN	305 (12)	BLACK	\$3.50
10231-61611	ALLIGATOR	305 (12)	BLACK	3.50
10231-61602	PIN	305 (12)	RED	3.50
10231-61605	PIN	305 (12)	YELLOW	3.50
10231-61604	PIN	305 (12)	GREEN	3.50
10231-61608	PIN	305 (12)	WHITE/BLACK	3.50
10231-61612	PIN	305 (12)	WHITE/BROWN	3.50
10231-61613	PIN	305 (12)	WHITE/RED	3.50
10231-61614	PIN	305 (12)	WHITE/ORANGE	3.50
10231-61615	PIN	305 (12)	WHITE/YELLOW	3.50
10231-61616	PIN	305 (12)	WHITE/GREEN	3.50
PART NUMBER	LEAD END	LENGTH mm (in.)	COLOR	PRICE
5061-1231	PIN	305 (12)	BLACK	\$3.50
5061-1232	PIN	305 (12)	YELLOW	3.50
5061-1233	PIN	305 (12)	WHITE/BLACK	3.50
5061-1234	PIN	305 (12)	WHITE/BROWN	3.50
5061-1235	PIN	305 (12)	WHITE/RED	3.50
5061-1236	PIN	305 (12)	WHITE/ORANGE	3.50
5061-1237	PIN	305 (12)	WHITE/YELLOW	3.50
5061-1238	PIN	305 (12)	WHITE/GREEN	3.50
5061-1239	PIN	305 (12)	WHITE/BLUE	3.50
5061-1240	PIN	305 (12)	WHITE/VIOLET	3.50
5061-1241	PIN	305 (12)	GRAY/BLACK	3.50
5061-1242	PIN	305 (12)	GRAY/BROWN	3.50
5061-1243	PIN	305 (12)	GRAY/RED	3.50
5061-1244	PIN	305 (12)	GRAY/ORANGE	3.50
5061-1245	PIN	305 (12)	GRAY/YELLOW	3.50
5061-1246	PIN	305 (12)	GRAY/GREEN	3.50
5061-1247	PIN	305 (12)	GRAY/BLUE	3.50
5061-1248	PIN	305 (12)	GRAY/VIOLET	3.50

NUMBER OF KITS REQUIRED BY LOGIC ANALYZER MODELS

	ANALYZER MODEL NUMBER									KIT PRICE
	1600A	1607A	1601A*	1602A	1610A/B	1611A	1615A	1620A*	10254A	
Quick Disconnect Kits 10231-68703 Data	3	3	2			1		3	1	\$30
10247-68701 Clock					1					\$10
10248-69501 Data					4		3			\$37.50
Threaded Probe Leads 10230-68701 Clock	1	1	1					1		\$12
Threaded Probe Leads 10231-68702 Data	3	3	2					3	1	\$30
Kit of 10 Miniature Probe Tips 10230-68702 (Order single tips as HP P/N 10230-62101).	3	3	2	2	4	1	4	3	1	\$22.50
										\$ 2.50

*No longer in production.

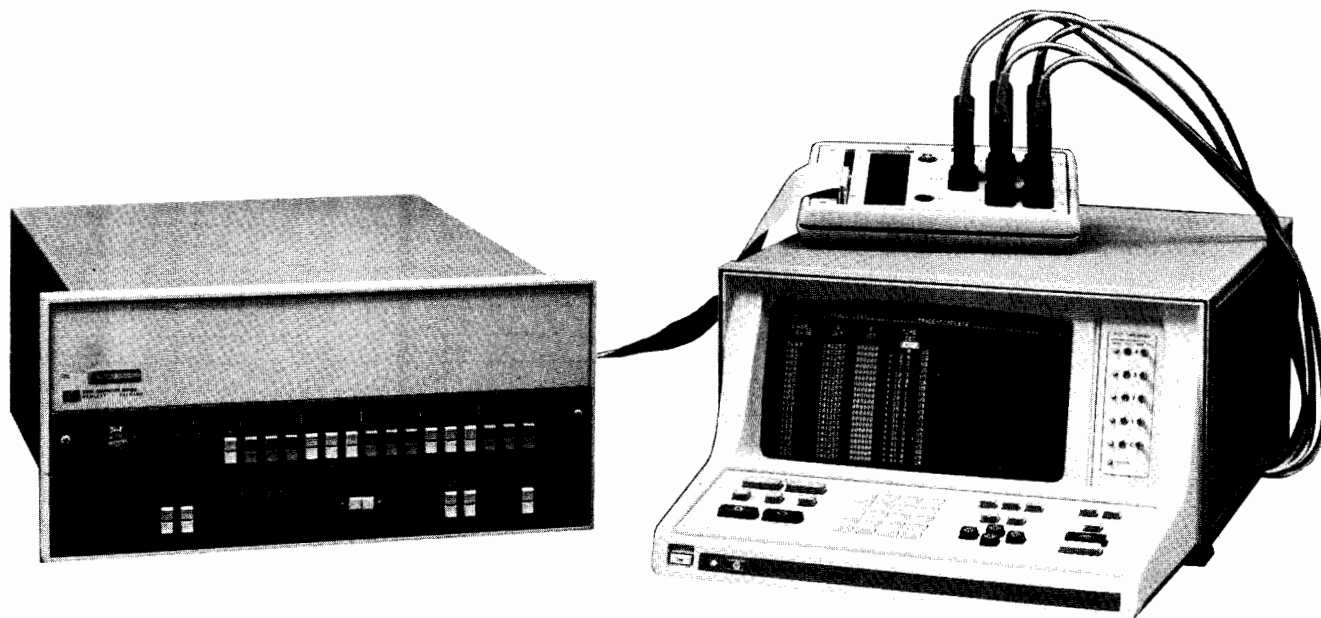

1610A with Interfaces

Interfaces

Three categories of interfaces are available for Hewlett-Packard logic analyzers: (1) general purpose, (2) minicomputer, and (3) HP-IB. The general purpose interfaces simplify the mechanical connections between the logic analyzer and the system under test, and provide some preprocessing capabilities to adapt and qualify signals from the system. Seven minicomputer interfaces give you access to address, data, and control line signals from specific minicomputers. Because these are dedicated interfaces, minicomputer interfaces have even more flexibility for preprocessing and selecting the signals you want

to monitor of the many active lines in the typical minicomputer. An HP-IB interface may be a monitor only or an active interface that adds the logic analyzer to a larger measurement system.

10277A/B/C/D General Purpose Probe Interface

For convenient connections between your analyzer and a digital system, Model 10277A/B/C/D has dedicated sockets for the analyzer probe pods, and cables with 40-pin connectors for the system under test. Wire-wrap boards in the interface carry active circuits to preprocess the system signals for the logic analyzer. These interchangeable boards can be set up for a variety of analysis modes, such as serial-to-parallel conversion, sorting out signals on multiplexed buses, generating ORed clocks from multiclock systems, etc. Analysis modes can be changed quickly by simply swapping boards. Option 001 for Models 10277A/B replaces one wire-wrap board with a prewired board that directly accesses address and data lines. The appropriate 10277 interface can be used with Models 1600S, 1610A/B, 1611A, and 1615A logic analyzers.

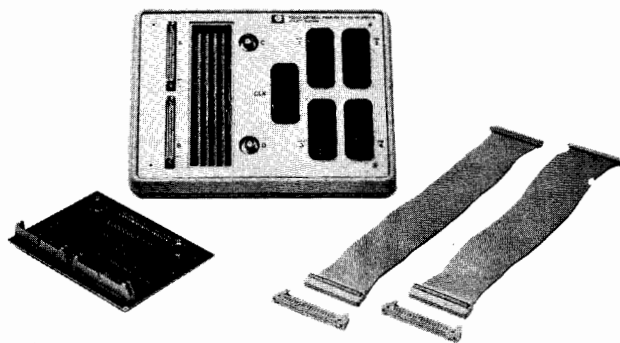

10277A General Purpose Probe Interface

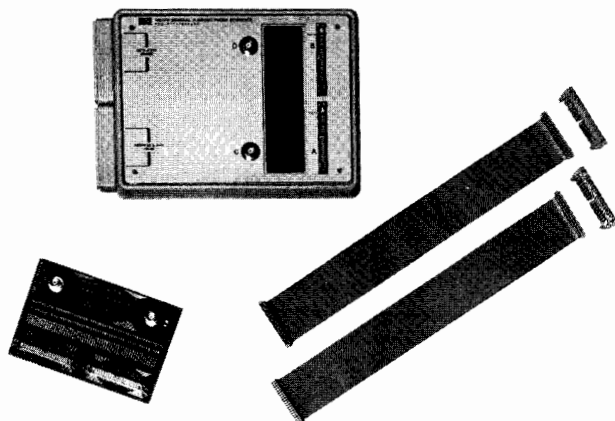

10277D General Purpose Probe Interface

10277A/B/C/D Interface Specifications

Input connectors: two 40-pin connectors to interface with a system. Two BNC connectors on the wire-wrap boards allow external signals or power to user-constructed circuits on the board.

Output connectors: four data connectors for HP logic analyzers with Model 10248 or 10231 data probes. One clock connector for Models 10247, 10230, or 10248B Opt. 001 clock probes. Model 10277D has two plugs for the two 40-pin connectors of the HP 1611A Logic State Analyzer.

Weight: net, 0.75 kg (1.7 lb); shipping, 2 kg (4.4 lb).

Accessories supplied: two removable interconnection wire-wrap boards (HP P/N 10277-66501 for Models 10277A/B/C, HP P/N 10277-66507 for Model 10277D), two 36 mm (1.4 in.) ribbon cables with 40-pin female connectors on each end (HP P/N 10277-61601), and two 40-pin male connectors (HP P/N 1251-3004).

Ordering Information

	Price
10277A Interface for 1610A	\$400
10277B Interface for 1610B or 1615A	\$400
Opt 001 (10277A/B only) replaces one wire-wrap board (HP P/N 10277-66501) with a prewired board (HP P/N 10277-66505) for connection to minicomputer interfaces; replaces 35.5 (14 in.) cable (HP P/N 10277-61601) with a 91.5 cm (3 ft) cable (HP P/N 10277-61602)	N/C
10277C Interface for 1600A or 1607A	\$400
10277D Interface for 1611A	\$475
10277-66501 Wire-wrap Board with Connectors (two supplied with Model 10277 Interface)	\$100
10277-66505 Prewired Wire-wrap Board	\$130



Minicomputer Interfaces

Interfaces for HP logic analyzers are available for seven minicomputer families. Minicomputer interfaces provide a simple, rapid connection between logic analyzers and the system under test, and preprocess system activity to produce signals suitable for the analyzers. The one or two printed circuit boards of each interface connect directly to the minicomputer mainframe or system bus to transparently monitor address and data buses and control lines. Interface boards have switches to qualify signals so that only particular activities can be monitored, as, for example, only reads, or only DMA outputs. Active circuits on the board assure transparent monitoring with buffering as required, and generate clock signals for the logic analyzer.

Minicomputer/Logic Analyzers Interfaces

INTERFACE MODEL	COMPUTER	NET WEIGHT kg (lb)	SHIPPING WEIGHT kg (lb)
10275A	PDP-11 (Digital Corp)	0.28 (0.6)	0.60 (1.3)
10276A	LSI-11 (Digital Corp)	0.2 (0.4)	0.32 (0.7)
10278A	HP 1000 M/E/F Series	0.8 (1.8)	1.40 (3)
10279A	NOVA 3 (Data General)	0.23 (0.5)	0.45 (1)
10280A	microNOVA (Data General)	0.23 (0.5)	0.45 (1)
10285A	HP 1000 L-Series	0.23 (0.5)	0.45 (1)
52126A	Intel MULTIBUS	0.23 (0.5)	0.45 (1)

HP-IB Interface Kits

Logic analyzer HP-IB interfaces allow you to add the measurement set of the analyzers to a system with other HP-IB compatible instruments for automated monitoring, higher-level analysis, and documentation. Refer to pages 22-26 for an overview of instruments available with HP-IB capability. HP-IB interfaces may be ordered as options or field kits.

Logic Analyzers/HP-IB Interfaces

LOGIC ANALYZER MODEL NUMBER	FACTORY-INSTALLED OPTION NUMBER	USER-INSTALLED KITS MODEL NUMBER
1602A Logic State Analyzer	001	10059A
1610A Logic State Analyzer, serial number prefix 1812A and below	003	10494A
1610A Logic State Analyzer, serial number prefix 1822A and above	003	10495A
1610B Logic State Analyzer	003	10496A
1615A Logic Analyzer	001	10069A

Performance Analysis

Using the second-generation logic analyzers with HP-IB capability and a smart controller creates a measurement system for higher-level evaluations of system performance. Model 1610A/B Logic State Analyzer or Model 1615A Logic Analyzer may be used to acquire data and provide front end storage. Data is sent across the HP-IB to an intelligent controller for post-processing. Model 9825A/35A/45A Desktop Computers or any HP-IB compatible computer can be programmed for user-defined tests and routines. The post processing results can then be displayed on a graphics terminal, printer/plotter, or the logic analyzer display. Typical analysis formats include histograms of system activity by frequency or time, software execution time profiles, or matrices of branching probabilities.

HP-IB Monitors

Two interfaces are available for directly monitoring activity on HP-IB lines. Model 10050A and 10051A HP-IB Adapter and Test Probe are used with Model 1602A Logic State Analyzer; refer to pages 179-180 for a description and specifications.

Model 10066A HP-IB Probe Interface is used with the 1610A/B Logic State Analyzer or 1615A Logic Analyzer to transparently monitor the 16 HP-IB lines. The interface connects directly to the bus and has pod sockets for the analyzer probes. Protocol violations in the handshake sequences set a flag for the analyzer and flash an LED on the interface. A clock source switch gives you a choice of acquiring talker asserted data (DAV), listener accepted data (NDAC), or parallel poll sequences. A pushbutton on the interface displays on the analyzer the state of quiescent lines on a quiet or stalled HP-IB bus.

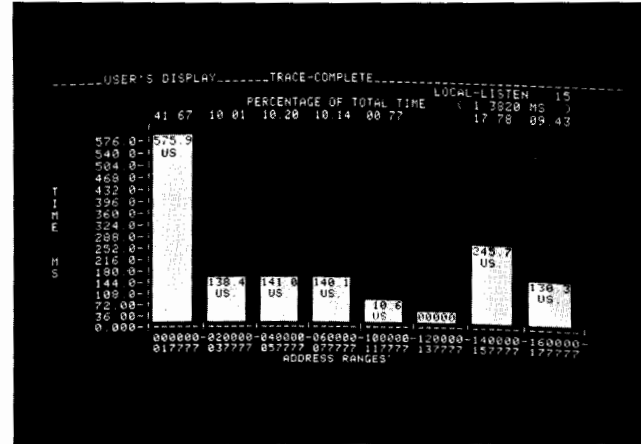

A logic analyzer with HP-IB interface and an intelligent controller are used for higher-level performance analysis. This histogram of occurrence counts is displayed on a 1610 Logic State Analyzer.

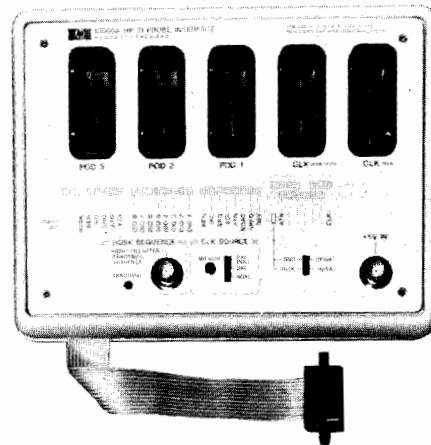

10066A HP-IB Probe Interface

10066A HP-IB Probe Interface Specifications

Input load: <400 μ A source or logic analyzer probe load.

Input Threshold: TTL fixed at approx 1.5V.

Maximum input: \leq 5.5V or logic analyzer spec.

Minimum input

Voltage: \geq 0.5V or logic analyzer spec.

Setup time: time data stable prior to clock edge, 20ns.

Hold time: time data stable following clock edge, 50 ns.

Power: +5V, 100 mA max.

Ordering Information

10059A HP-IB Interface Kit for 1602A	\$ 300
10066A HP-IB Probe Interface, 1610A/B and 1615A	\$ 300
10069A HP-IB Interface Kit for 1615A	\$ 500
10275A PDP-11 UNIBUS Interface*	\$ 300
10276A LSI-11 Q-Bus Interface*	\$ 375
10278A HP 1000 M/E/F Series Interface*	\$ 650
10279A NOVA 3 Interface*	\$ 500
10280A microNOVA Interface*	\$ 500
10285A HP-1000 L-Series Interface*	\$ 350
10494A HP-IB Interface Kit for 1610A with Serial Number Prefix 1812A and below	\$1200
10495A HP-IB Interface Kit for 1610A with Serial Number Prefix 1822A and above	\$ 900
10496A HP-IB Interface Kit for 1610B	\$ 800
52126A Multibus Interface*	\$ 300
*Opt 001 adds 10277A/001 GP Interface	add \$ 400
*Opt 002 adds 10277B/001 GP Interface	add \$ 400

Analyzer / Converter Cables
10254-61601

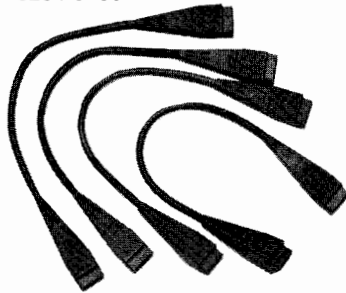

Trigger Bus Cable
10236A



Test Cable
01611-61612

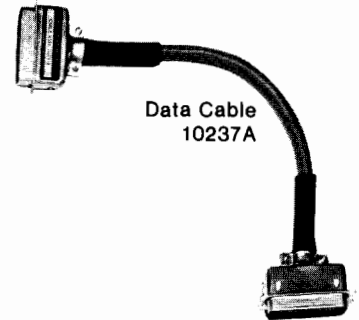

Data Cable
10237A

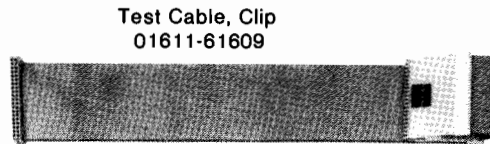

Test Cable, Clip
01611-61609

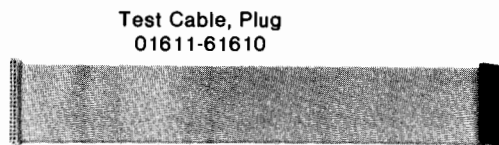

Test Cable, Plug
01611-61610

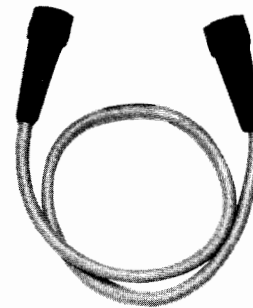

Analyzer / Printer Cable
09866-61630

Cables

The following cables are supplied with the respective instruments and options on initial order. They are included for convenience in ordering replacement parts.

Models 10236A Trigger Bus Cable and 10237A Data Cable

These cables connect the 1600A and 1607A Logic Analyzers to double the 16-bit word capacity to 32-bit word width. Model 10236A Trigger Bus cable also provides the connection of Model 10254A Serial-to-parallel Converter to the 1600A or 1607A Analyzers. The appropriate number of cables are supplied with the 1600S and 10254A.

Models 1600S Logic Analyzer / 10254A Serial-to-parallel Converter Interconnecting Cable (HP P/N 10254-61601)

These interconnecting cables transmit the clock and data output of the 10254A Serial-to-parallel Converter to 1600A or 1607A Logic Analyzer. Four cables are needed and are supplied with Model 10254A.

Models 1610A/B Logic Analyzers and 9876A Printer Cable

A cable is available to connect the 1610A/B Logic Analyzer to either Model 9876A or 9866A/B Thermal Printer. This cable, HP P/N 09866-61630, is provided with Option 004 for the 1610A/B. The two end connectors can be ordered alone, vendor Burndy, P/N BTO 6B () 14-19PAA143.

Model 1611A Logic Analyzer Cables

Three test cables are supplied with Model 1611A Logic Analyzer, and provide the connections between the Analyzer's microprocessor

probe and the microprocessor under test. Any of these three cables can be used to connect the microprocessor to the 1611A input.

Connectors

Model 1602A Analyzer Probe Connectors

Several kits and units are available to make more convenient connectors for Model 1602A Logic Analyzer. HP P/N 01602-68701 is an assembly of quick disconnect pod with a printed circuit board and 30.5 cm (12 in.) leads; no slip-on probe tips are included. HP P/N 01602-68702 includes the quick disconnect plastic pod halves and a printed circuit board, but no leads are included. An unloaded printed circuit board, HP P/N 01602-26506, is available for use with the quick disconnect plastic pods. This probe/system interface is a standard two row, edge connector which is easily added to your instrument during development.

Ordering Information

	Price
10236A Trigger Bus Cable	\$20
10237A Data Cable	\$60
01602-68701 Probe Connector with Leads	\$80
01602-68702 Quick Disconnect Kit	\$49
01602-26506 Unloaded PC Board	\$10
01611-61609 30.5 cm (12 in.) Test Cable with a 40-pin female connector and 40-pin clip	\$95
01611-61610 30.5 cm (12 in.) Test Cable with a 40-pin female connector and 40-pin plug	\$55
01611-61612 10.2 cm (4 in.) Test Cable with a 40-pin female connector and a 40-pin plug	\$50
09866-61630 Printer Cable	\$250
10254-61601 Cable, each	\$145



Probe/System Connector Kit

The Hewlett-Packard probe/system connector kit (HP P/N 5061-1263) includes five plastic connector bodies (HP P/N 01610-87601) and fifty connector pins (HP P/N 01610-06101). By incorporating these connectors into your system during initial design, you have easy access to signals necessary for testing with an HP Logic Analyzer. Alternatively, these connectors can be installed on an interface board which can then be connected to a system with a ribbon cable.

Connectors can be mounted on an exterior surface of an internal circuit board with only a portion of the body extending through an external panel. Two notches in the connector body mate with the feet of the Analyzer probes to assure proper alignment.

If you want to solder wires directly to probe connector pins, order hollow pins, HP P/N 1251-4305. When soldering pins to the printed circuit board, a dummy fixture or other probe should be used to keep the pins parallel. A dummy probe can be fabricated using a pod cover (HP P/N 5040-8125), four screws (HP P/N 0624-0306), and the pod housing for a logic probe. For probe models 10230C, 10231C, and 10247A use pod housing HP P/N 5040-8010; for probe models 10248A/B/C, 10248B Opt 001, and HP P/N 01611-62101 use pod housing HP P/N 5040-8011.

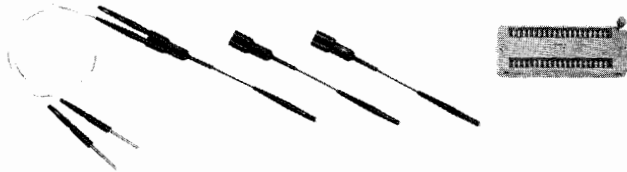

5061-3613 Demultiplexing Adapters
1200-0623 40-pin Socket

Special Connectors

HP P/N 5061-3613 Demultiplexing Adapter is a 95 mm (3.7 in.) 2-for-1 adapter which can route a system signal to two monitoring lines. In combination with clock qualifiers, these leads allow you to monitor multiplexed pins on microprocessors and display the two signals in parallel on the logic analyzer display.

HP P/N 1200-0623 is a 40-pin, zero insertion force socket for use in a circuit board for damage-free insertion and removal of microprocessors and 40-pin DIPs. HP P/N 1200-0682 is a socket for Model 1611A Logic Analyzer microprocessor probe cable, and prevents header breakage. This socket also protects the pins for any 40-pin DIP that is removed or replaced frequently.

Accessories and Testmobiles

Testmobiles

Four styles of testmobiles can be used with your logic analyzer: Models 1006A, 1007A, 1008A, and 1117B. A variety of options are available for add-on drawers and shelves. Refer to page 232.

For the 64100A Development Station and logic analyzers with horizontal keyboards, Model 64030A Development Station Cart is a convenient, 690 mm. (27 in.) high table-level working surface which rolls easily on ball casters. A large recessed shelf under the table top provides convenient storage space for manuals and parts. The wheel base matches the 600 mm x 760 mm. (24 in. x 30 in.) table-top for stability.

Adapter Plate

An adapter plate, HP P/N 5061-1213, can be used to fasten Model 1740 and 1720 Series Oscilloscopes to the Model 1607A Logic Analyzer, the 1600A Logic Analyzer to the 1607A Logic Analyzer, or either of these two analyzers to Model 10254A Serial-to-Parallel Converter. This part consists of an aluminum plate and a strap for the top unit.

Rack Mount Slides and Adapter

Hardware is available to install some logic analyzers in standard 483 mm (19 in.) racks. Model 10491B Rack Mount Adapter can be used with Model 1600A Logic Analyzer. Fixed slides (HP P/N 1490-0714) and pivot slides (HP P/N 1490-0719) can be used in conjunction with this rack adapter.



64030A Development Station Cart and 1610B Logic Analyzer

Transit Cases

Transit cases are available for some of the logic analyzers. A standard transit case (HP P/N 9211-2459) can be used for Model 1600A Logic Analyzer, and it is also suitable for the 1700 Series Oscilloscopes. For Model 1602A Logic Analyzer, use Model 10058A Transit Case. The transit case for Model 9866A/B Printer is HP P/N 9211-0839. To add wheels to these cases, order Field Kit HP P/N 1490-0913.

For all other analyzers, have your Field Engineer contact the HP Corporate Parts Center where a specialist is available to advise the best solution for transporting your analyzer.

Pouches

Three pouches are available for use with logic analyzers: HP P/N 1540-0325 is a large pouch which will hold all of the accessories for Model 1610A/B, 1611A, or 1615A Logic Analyzer. HP P/N 1540-0320 is a small pouch for the 10230/10248 probes. HP P/N 1540-0440 is a medium pouch for Model 1611A Logic Analyzer probe.

Keyboard Covers

A hard, protective keyboard cover (HP P/N 5040-0588) is available to fit the keyboards of Models 1611A and 1615A Logic Analyzers. Front panel cover for Model 1600A is HP P/N 5040-0516.

Ordering Information

	Price
1006A Testmobile	\$215
1007A Testmobile	\$350
1008A Testmobile	\$390
1117B Testmobile	\$615
10058A Transit Case (1602A)	\$50
10491B Rack Mount Adapter (1600A)	\$150
64030A Development Station Cart	\$300
0624-0306 Screw, each	\$0.07
1200-0623 40-Pin Socket	\$24.50
1200-0682 Socket for 1611A	\$12
1251-4305 Hollow Connector Pin, each	\$0.04
1490-0714 Fixed Slides	\$110
1490-0719 Pivot Slides	\$170
1490-0913 Field Kit, Wheels	\$210
1540-0320 Small Pouch	\$4.70
1540-0325 Large Pouch	\$31
1540-0440 Medium Pouch	\$12
5040-0516 Panel Cover (1600A)	\$11.50
5040-0588 Keyboard Cover	\$49
5040-8010 Pod Housing	\$3.80
5040-8011 Pod Housing	\$3.80
5040-8125 Pod Cover	\$2.50
5061-1213 Adapter Plate	\$50
5061-1263 Probe System Connector Kit	\$20
5061-3613 Demultiplexing Adapter	\$11
9211-2459 Transit Case (1600A)	\$490
01610-87601 Connector Body	\$3.40
01610-06101 Connector Pin, each	\$0.50

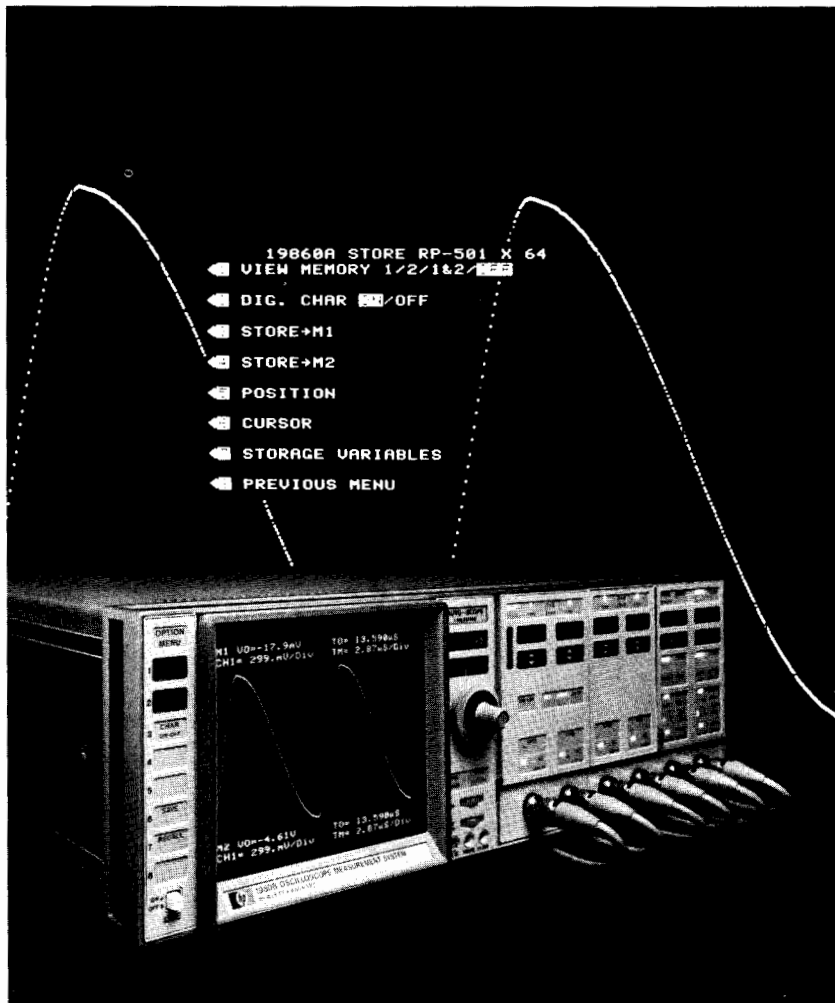

Introduction

The oscilloscope—the most general purpose and basic tool of the electronic industry—has evolved into an even more powerful and versatile measurement tool. Hewlett-Packard technological innovations provide expanded levels of performance in all three primary oscilloscope application areas: waveform viewing, timing analysis, and instantaneous voltage measurement.

Waveform Viewing

Many measurement applications involve signals that ordinarily result in very faint traces. Hewlett-Packard's variable persistence oscilloscopes solve this problem by operating similar to conventional repetitive sweep instruments except that signals are displayed as bright, high contrast, flicker-free traces. Also, there is no waiting for storage operation which makes it easy to view a high speed, randomly occurring glitch in the presence of a repetitive signal.

Hewlett-Packard's 1980A/B Oscilloscope Measurement System includes a built-in feature, called Auto-Scope, which automatically sets intensity, deflection factors, sweep speeds, trace position, and signal conditioning necessary to obtain a display of the input

signals. This allows an operator to rapidly obtain a display without adjusting individual controls and quickly provides a starting point for test procedures.

The Model 1980A/B is a fully programmable oscilloscope. In production test applications, the 1980A/B provides the user with the best of both worlds: the powerful diagnostic ability of an oscilloscope waveform display plus the tremendous productivity gains associated with a fully automated instrument operation.

Timing Analysis

The ever increasing use of digital circuits in today's products and systems has resulted in a need for more convenient and accurate time interval measurements. Digital circuits fail to function properly for a variety of reasons, but often the problem is caused by a timing error. Hewlett-Packard's family of time interval oscilloscopes are designed to track down and help the user identify elusive timing violations such as clock phasing discrepancies, setup and hold time violations for a flip-flop, or unexpected propagation delays.

The HP Model 1743A offers time interval averaging measurements that provide accuracies of 0.002% of reading and 100 pico-

second resolution. The 1743A's technology also offers several new measurement capabilities: a triggered measurement mode in which the time interval reading will track changes in the input signal without operator intervention and a "first pulse" feature that enables the leading edge of the signal starting the oscilloscope main sweep display to be used as a reference for precise time interval measurements.

The 275 MHz 1722B, 1725A, and 1727A; 200 MHz 1715A; and 100 MHz 1742A all offer the Hewlett-Packard pioneered two-marker time interval measurement system. For repetitive measurement applications, the HP-IB controlled 1980A/B Oscilloscope Measurement System offers a powerful repertoire of time interval measurement facilities.

Instantaneous Voltage Measurement

The modern oscilloscope is such a powerful waveform viewing, diagnostic, and timing analysis instrument that many users tend to forget its ability to make instantaneous voltage measurements on extremely complex, wide bandwidth signals. The HP Model 19860A Digital Waveform Storage enhancement to the 1980A/B Oscilloscope Measurement System provides from one to 501 instantaneous voltage measurements on any viewable signal with resolution of one part in a thousand. These voltage measurements are available for on-screen viewing, waveform plotting, or supplied via HP-IB for computer analysis.

The HP Model 1722B Oscilloscope enables the user to combine on-screen cursors and a built-in microprocessor to obtain dc voltage, waveform voltage, and percent amplitude measurements.

Selecting an Oscilloscope

When selecting an oscilloscope, you will need to match your present and future measurement needs with the oscilloscope feature set. Price is always a consideration and incremental cost must be weighed against incremental measurement capability. In many cases, ease-of-use should be considered along with measurement accuracy and the overall feature set. Some of the major feature decisions include:

- Bandwidth
- Number of channels
- Rack or cabinet configuration
- Portability
- Plug-in versatility
- Vertical and horizontal accuracy
- Ease-of-use
- Price
- Time interval capability
- Variable persistence storage
- Various combinations of the above
- HP-IB programmability
- Digital waveform storage

Hewlett-Packard manufactures several oscilloscope families. Each family optimizes a different combination of the considerations previously listed. Refer to the Oscilloscope Selection Chart on page 197 for feature sets and page references.

Fully Programmable Time Domain Measurements

Hewlett-Packard's Oscilloscope Measurement System is a revolutionary, fully programmable, HP-IB compatible instrument with digital waveform storage that makes significant contributions in viewing, measuring, and processing of time domain waveforms. These contributions are achieved by using a computer architecture with instrument operation controlled by a microprocessor. The computer architecture permits physical separation of the analog measurement circuits and the front panel controls which allow the front panel to be laid out in a logical hierarchy. A single, digitally encoded rotary control replaces the numerous rotary controls on other instruments which simplifies operation.

HP-IB Programmable

With complete digital control of instrument operation, computer control through an HP-IB interface is easily accomplished. A computer can establish front panel settings and communicate with an operator by writing instruments on the CRT through its character generator. When this automated capability is used in repetitive testing, complete step-by-step procedures can quickly direct operators through complex tests. Additionally, the computer can lock out controls to prevent inadvertent actuation which would result in time-consuming, erroneous measurements. Furthermore, front panel setup and variable functions (e.g., deflection factors, sweep speeds, etc.) can be read by the computer for calculation, evaluation, and, if desired, print out for permanent record. With computer control, today's complex products can be more extensively tested to assure high quality while reducing both measurement time and cost.

Fully Automatic Operation

With the addition of the Model 19860A Digital Waveform Storage capability, completely automatic measurements under com-

puter control are possible. For example, a waveform can be automatically scaled by the Auto-Scope routine resident in the 1980 operating system. The displayed signal can then be digitized, stored, and sent to a computer for analysis.

Automatic Test System

The 1980/19860A system can greatly improve the efficiency of test systems by completely automating time domain measurements. This fully programmable system can be set up to acquire a signal, digitize it, and transfer it to a computer for automatic analysis to provide complete answers without operator intervention. A series of standard signals may be digitized and stored in a computer to build a library of references for automatic testing. Now, as tests are performed, signals are automatically compared in software.

Test procedures are easily developed because the 1980 uses a "learn string" to define all setup information. All that is required is to store a reference waveform along with the learn string that was used to set up the instrument. When the test is performed, the stored information is simply sent back to the 1980 and text may be written on the CRT to explain the adjustments.

Semiautomatic Testing

In applications where operator interaction is necessary, such as circuit setup, calibration, or troubleshooting, the programmable 1980/19860A capabilities can improve productivity by eliminating operator front panel setup time and possible errors. A controller can set up front panel controls and write a reference waveform with text on the CRT to direct an operator through a calibration sequence. The operator only has to make circuit adjustments so that a real time waveform is positioned between two reference waveforms. All of the information for text, instructions, reference waveforms, and front

panel setup, can be stored in a data base on tape or disc files.

Furthermore, the 1980 front panel controls can be redefined in a programmable station. For example, the rotary control could be redefined to control the adjustment of another instrument as directed by instructions on the CRT. In a similar fashion, the soft keys could be redefined with the appropriate instructions adjacent to them to control the modes of operation of other instruments in a programmable system.

The start and stop cursors can also be used to improve measurement efficiency by taking advantage of operator interaction. For instance, after a waveform is captured, the operator can position the cursors on critical points of a waveform that would normally require considerable controller software to define automatically. The cursor positions can then be read by the controller with the necessary computations quickly accomplished.

Bench Operation

In bench applications with a controller, an engineer can easily develop and maintain a data base to log the results of design changes. When combined with other programmable instruments, long tests can be automatically accomplished to record any changes in circuit response with design changes. Also, with the appropriate controller software, answers to frequent measurements can be obtained with the press of one of the 1980 soft keys.

Without a controller, the 1980/19860A can be used as a traditional oscilloscope with the added benefits of the easy-to-use front panel and software features. The Auto-Scope capability acquires a signal with the press of one key reducing the time for initial instrument setup. Frequently used front panel setups can be saved in eight local registers and quickly recalled to reduce measurement time and improve productivity. Slow repetition rate fast signals can be captured and displayed as bright, nonfading signals by the digital waveform storage capability.





OSCILLOSCOPES

1700 Series

The 1700 Series

A Family of Solutions

The 1700 family of oscilloscopes provides a wide selection of quality instruments for lab, production, and service applications. The product line is composed of oscilloscopes ranging in bandwidth from 100 to 275 MHz, with both conventional and variable persistence/storage CRTs available in each bandwidth category.

The 1740 Series

This series offers a selection of five oscilloscopes in the 100 MHz category; 1740A, 1741A, 1742A, 1743A, 1744A. All of the 1740 series are dual channel, offer a third channel trigger view, vertical sensitivity to 1 mV (at reduced bandwidth), as well as selectable input impedance (50Ω/1MΩ). Models 1741A and 1744A offer the additional capability of variable persistence/storage.

High Frequency 1700's

For high frequency applications, there is a selection of four oscilloscopes ranging from 200 to 275 MHz with both conventional and variable persistence/storage CRTs; 1715A, 1725A, 1722B, and 1727A. These instruments are all delta time oscilloscopes, which are ideal for use in the design, manufacture, and testing of high speed computers, peripherals with fast interface logic, high speed digital communications, and high frequency RF and analog applications.

Variable Persistence/Storage

The 100 MHz 1741A and 1744A combine with the 1727A to form an excellent selection of variable persistence/storage oscilloscopes. HP's advanced CRT technology permits high variable persistence writing speeds with blind times identical to conventional oscilloscopes. Extremely fast variable persistence and stored writing speeds are available on the 1744A and the 1727A with the HP developed expansion storage technique. These capabilities combine with an auto-intensity circuit to create an instrument that is extremely general purpose. In fact, more and more of these oscilloscopes are being used as a "one oscilloscope solution" to solve the wide variety of measurements encountered every day, rather than the special purpose tool of the past.

Delta Time Measurements

All 1700 series instruments have delayed sweep time bases for differential timing measurements. Several of these instruments also have the Hewlett-Packard developed time interval measurement capability known as delta time. This delta time system incorporates two intensified markers that define the start and stop events and makes time interval easier and more accurate than single marker systems. Furthermore, the interval can be read directly on the helical, an optional DMM, or on some models the built-in LED display.

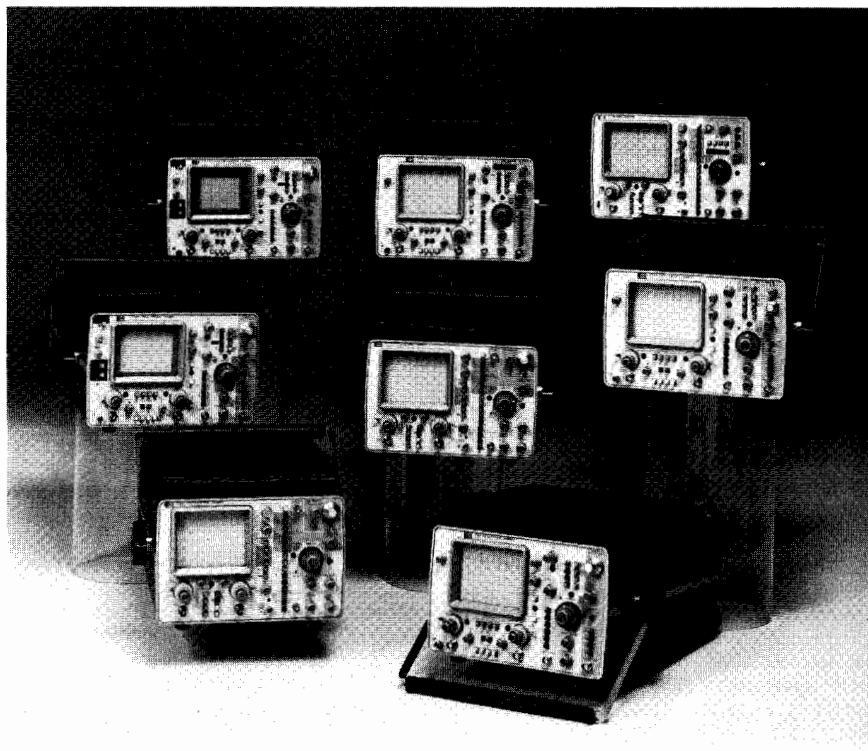

1700 Series Options

DMM/Temperature Probe—DMM and temperature probe are available on the 1740A, 1741A, 1742A, 1715A, 1725A, and 1727A. This is a 3½ digit auto-ranging and auto-zeroing DMM built into the top cover of the instrument capable of displaying time intervals on delta time oscilloscopes, as well as supplying the five basic measurements: ac and dc volts, ac and dc current, and resistance. By adding a Model 10023A Temperature Probe to the DMM, fast, accurate temperature measurements are accomplished easily with its "pencil-like" tip that easily accesses components.

TV Sync—Hewlett-Packard's Option 005 offers triggering capability on composite video waveforms that have negative sync pulses. The option features a variety of display enhancements including field selection, line scan, and single line scan. This option is available on the 1740A, 1741A, 1742A, 1715A, and 1725A.

Time and State Display—Option 101 permits one button switching between time domain waveforms and data domain state displays. The state display is obtained from the 1607A, a 16-channel logic state analyzer. The outputs of the 1607A are displayed on the 1700 series oscilloscopes via rear panel inputs.

Low Frequency 500 kHz

Low frequency oscilloscopes, such as HP's 1200B, 1201B, and 1205B, which have 500

kHz bandwidth, are used in education, medicine, system monitors, engineering, production, and some field service applications. The 1200 series oscilloscopes offer 100 μV and 5 mV sensitivity, differential inputs, solid state, and lightweight construction, as well as reliable operation.

15 MHz

In the dc to 15 MHz range, Models 1220A and 1222A dual-channel oscilloscopes are ideal for industrial and educational applications. Logical front panel layout, large 8 x 10 cm internal graticule, and automatic triggering assure easy operation in all environments. Model 1222A has all of the features of the 1220A plus a delay line that allows viewing of the leading edge of the signal that triggered the sweep.

Accessories

Hewlett-Packard offers a full line of quality accessories designed to meet a wide variety of applications. Several models of testmodules offer convenient portability for your oscilloscopes or instrumentation systems. A selection of passive, active, current, and temperature probes, including HP's popular miniature probes, complements applications for most any oscilloscope. Portable power supply, camera, adapters, and terminations round-out the accessories which will help you get the most out of your oscilloscope investment.

Completing the Oscilloscope Solution . . . Support Literature

A comprehensive selection of support literature is available on the oscilloscope product line. Application notes, product notes, programming guides, and data sheets help you get the maximum measurement capability out of your particular oscilloscope.

Seminars

Seminars are an excellent vehicle to help engineers and technicians learn more about their Hewlett-Packard oscilloscope, whether the information concerns applications, operation, or maintenance.

Maintenance training classes are offered several times each year at the Colorado Springs Division. These seminars, directed towards calibration and repair technicians, teach operation, circuit theory, calibration, and troubleshooting to the component level. A nominal fee is charged to cover study materials, manuals, etc. Contact your HP field engineer for information about a specific instrument seminar.

Operation/application seminars are also arranged on an individual basis by field engineers as a pre- and post-sales enhancement. These seminars inform engineers and technicians about special considerations in respect to specific applications and modes of operation: probing, bandwidth and time base errors, etc. Categories such as conventional oscilloscopes (probing, horizontal accuracy, etc.), variable persistence/storage (basic theory, operation), and programmability of the 1980 are available.

Reliability/Quality

Hewlett-Packard oscilloscopes maintain the high standard of quality that is present throughout the company. Two programs insure that this quality remains an integral part of Hewlett-Packard oscilloscopes: 1) an overall reliability program and 2) an internal quality program.

The overall reliability program stresses "designing reliability in." This comprehensive program starts at the lab prototype



stage, where temperature and environmental tests identify marginal components and even potential design problems. The program continues throughout the entire development cycle of a product and ends with a full environmental and life test prior to release.

The internal quality program emphasizes

"do it right the first time" and affects all areas of operation: production, shipping, order processing, service, and the lab. This program includes quality audits that periodically check instrument standards to insure that the high quality standards are continuously met.

Oscilloscope Selection Chart

Characteristics	1700 Series										180 Series	1220A 1222A	1200 Series			**1980A/B
	1715A	1722B	1725A	1727A	1740A	1741A	1742A	1743A	1744A		50 MHz, 100 MHz	15 MHz	1200B	1201B	1205B	
Bandwidth	200 MHz	275 MHz	275 MHz	275 MHz	100 MHz	100 MHz	100 MHz	100 MHz	100 MHz		50 MHz, 100 MHz	15 MHz	500 kHz	500 kHz	500 kHz	100 MHz
Deflection Factors/Div.	5 mV to 5 V	10 mV to 5 V	10 mV to 5 V	10 mV to 5 V	1 mV* to 20 V	1 mV* to 20 V	1 mV* to 20 V	1 mV* to 20 V	1 mV* to 20 V		5 mV Min.	2 mV to 10 V	0.1 mV to 20 V	0.1 mV to 20 V	5 mV to 20 V	2 mV to 10 V
Sweep Speeds/Div.	1 ns to 0.5 s	1 ns to 0.5 s	1 ns to 0.5 s	1 ns to 0.5 s	5 ns to 2 s	5 ns to 2 s	5 ns to 2 s	5 ns to 2 s	5 ns to 2 s		5 ns to 1 s	10 ns to 0.5 s	0.1 μs to 5 s	0.1 μs to 5 s	0.1 μs to 5 s	5 ns to 1 s
Channels	2	2	2	2	2	2	2	2	2	2, 4	2	2	2	2	2	2, 4
Time Measurements	•	•	•	•				•	•							•
Variable Persistence Storage				•		•			•	•				•		
3rd Channel Trigger View					•	•	•	•	•							•
TV Sync	Opt		Opt		Opt	Opt	Opt				•					
Differential Inputs										•	•		•			
Optional Logic State Switch	•	•	•		•	•	•	•								
LED Readout/DMM	Opt	•	Opt	Opt	Opt	Opt	Opt	•								•
Page	211	211	211	211	204	204	204	204	204	216	222	220	220	220	220	198

*With X5 vertical magnification at reduced bandwidth.

**Fully programmable, HP-IB.



OSCILLOSCOPES

Oscilloscope Measurement System

Models 1980A/B

- Fully HP-IB Programmable
- Expandable Measurement Capability
- Easy-to-Use Front Panel
- Auto-Scope Automatically Scales Waveforms
- Optional Digital Waveform Storage
- CRT Text for Operator Instructions

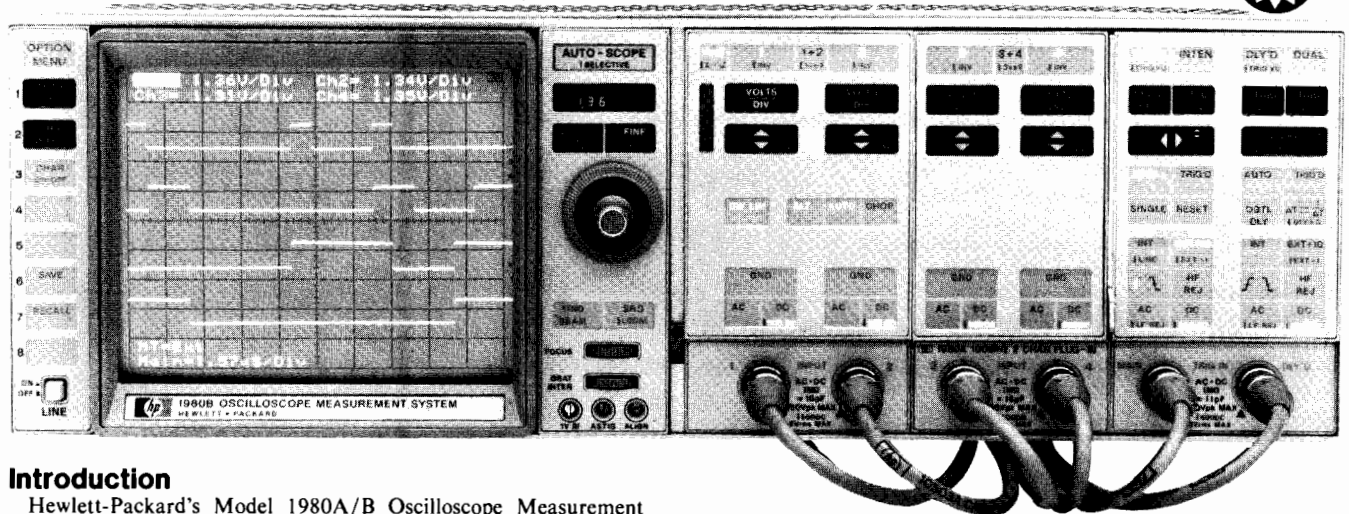

Introduction

Hewlett-Packard's Model 1980A/B Oscilloscope Measurement System is a revolutionary, fully programmable, time domain instrument based on a computer architecture. This automated, HP-IB compatible instrument makes significant contributions in the viewing, measuring, and processing of time domain waveforms. Improved measurement capability is achieved with the computer architecture design that permits internal operation to be controlled by a microprocessor. This results in an easy-to-use instrument with an extensive feature set. Internally, the instrument is divided into eight independent functional blocks that interface with each other over a bus structure. This extensive digital control permits many features not in other oscilloscopes, including programmable hardware and firmware expansion, an easy-to-use front panel, autoranging, complete programmability, and digital waveform storage.

In its basic configuration, the 1980 offers two 100 MHz analog measurement channels with continuous 2 mV to 10 V/div deflection factors, two independent and continuous main and delayed sweeps from 5 ns to 1 s/div, main or delayed trigger view, both delta time and voltage measurements, an Auto-Scope feature for automatic signal scaling, and many other features. These capabilities are combined with an innovative front panel design with color-coded keys and a single rotary control. The internal microprocessor scans the front panel for any key activation and variable control changes and then sets the instrument. Because these functions are controlled digitally by the microprocessor, they can also be programmed quite easily through the HP-IB interface. This programmability allows instrument setup to be done automatically by a computer which eliminates errors and greatly reduces setup time.

Enhancements

The basic instrument also contains provisions for expanded measurement and control capabilities in the form of additional hardware or firmware. Hardware expansion modules, such as the two-channel 1950A, fit into a front panel compartment and contain analog and digital interfaces for measurement integrity and programmability. Firmware expansion is through the addition of up to four preprogrammed 4k ROMs that provide either additional control capabilities or data manipulation. Digital waveform storage is another form of enhancement that provides completely automatic measurement capability.

Programming

Remote programmed operation is through the standard HP-IB port that interfaces through the internal digital bus with all functional blocks. This remote operation allows programming of all measurement parameters (i.e., deflection factors, sweep speeds, etc.),

SIMPLIFIED BLOCK DIAGRAM OF 1980A/B ARCHITECTURE

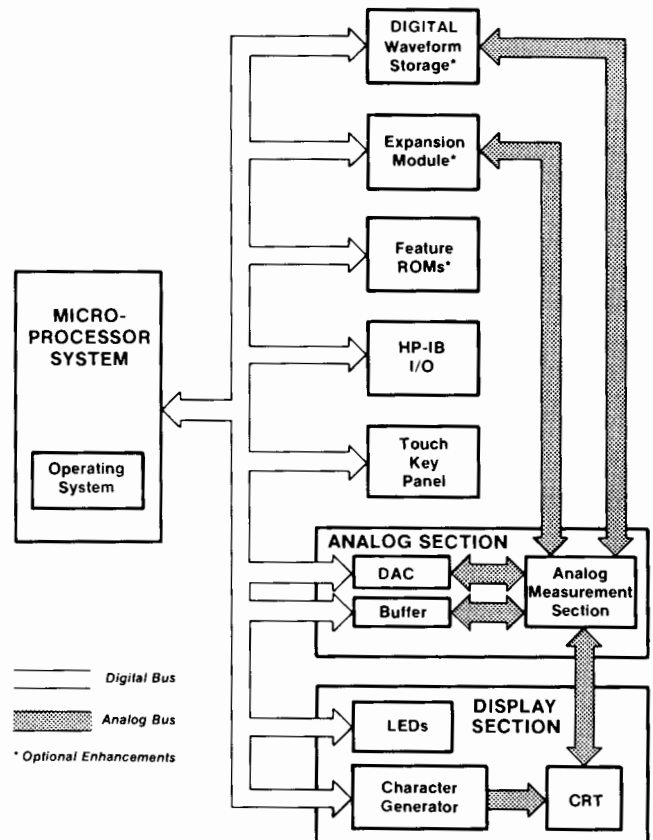

touch key setup, writing of instructions on the CRT through an ASCII character generator, and accessing of all installed enhancements. Conversely, the front panel status, including measurement parameters, and, when installed, digitally stored waveforms, may be read by a computer.

Front Panel

The internal computer architecture made it possible to incorporate an extremely easy-to-use, space efficient, touch key panel which is arranged in a logical manner. The front panel controls are simply contact closures which are constantly scanned by the microprocessor for actuation. A single, digitally encoded rotary control is used to control all variable functions to further simplify the front panel. An increase of control functions without an increase of density is achieved with shifted function keys that access secondary functions or protect certain modes.

The front panel is divided into five operating sections which are arranged for efficient operation and fast familiarization. The top row of keys controls the basic operating modes; dark keys in the second and third rows are variable functions that are assigned to the rotary control for adjustment. The remaining keys are setup functions used to establish input signal and trigger conditioning.

Menus

A series of keys to the left of the CRT are designated as soft keys which access a series of menus. When the Option Menu key is pressed, a listing of self-tests and installed firmware and/or hardware enhancements is displayed. Accessing the desired test only requires pressing the indicated soft key which then displays a menu for that function. The menus include instrument preset, front panel calibration, automatic delay and input amplifier balancing, confidence tests, and front panel setting of HP-IB address and operating modes. The menus are automatically updated as hardware and firmware enhancements, such as the 19860A Digital Waveform Storage, are added.

Calibration

The computer architecture and microprocessor based operating system provide a new method of calibration. This calibration can be performed from the front panel in less than 45 minutes, without removing the covers and with little or no test equipment. Calibration can now be performed on-site without the need for removal to a calibration lab. In production environments, a more accurate calibration is achieved with the 1980A/B in its test bay or rack thermal operating environment.

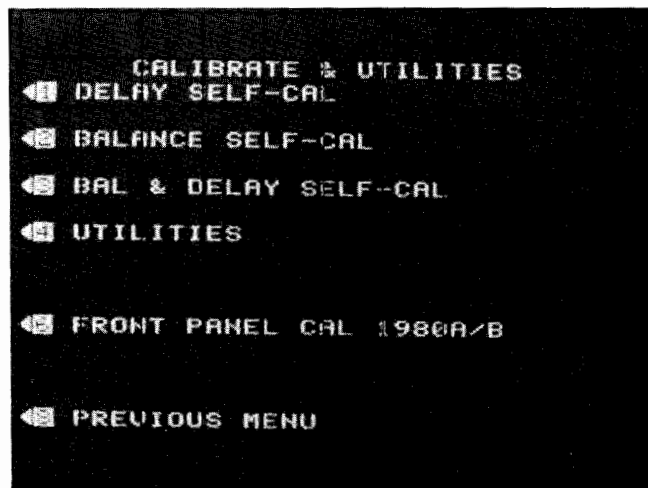

Self-contained instructions guide the calibrator through the entire 1980A/B calibration.

The 1980 can be calibrated using its internal calibrator signal with some degradation of accuracy but without the need of any external test equipment. Additionally, calibration requires no or minimal reference to a service manual since the complete step-by-step calibration procedure is displayed on the CRT. When stepping through the calibration procedure, offsets and variances are stored as calibration fac-

tors in nonvolatile RAM. When variable function adjustments are made for new measurements, the software calibration factors are used to assure that only calibrated measurements are made.

A rear panel slide switch prevents unauthorized access to the internal calibration factors. Placing a calibration sticker over the recessed switch insures that the calibration is retained. This innovative front panel calibration capability greatly reduces calibration time and the need for specialized test equipment.

Digital Waveform Storage

Adding the Model 19860A Digital Waveform Storage to the 1980 makes waveform acquisition and analysis completely automatic. The 1980/19860A combination greatly reduces measurement time by eliminating operator involvement in complex, repetitive measurements. Repetitive events to 100 MHz or single-shot events to 5 kHz (10 points per period) may be captured, displayed, and sent over HP-IB to a computer for analysis.

In the repetitive mode, signals are sampled at discrete points on successive sweeps with the delay generator used as the sample clock. The number of horizontal data points can be selected in steps of 1, 3, 6, 11, 21, 101, 251, or 501 points which allows the optimum choice between acquisition time and resolution. In the single-shot mode, signals are captured in one sweep with the sample clock provided by the crystal controlled processor clock. The number of data samples is selectable in the same manner as the repetitive mode.

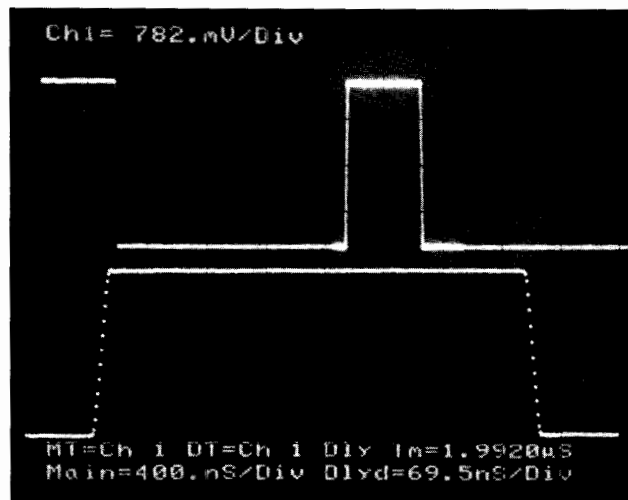

The intensified portion of the waveform is digitized with all 501 horizontal points.

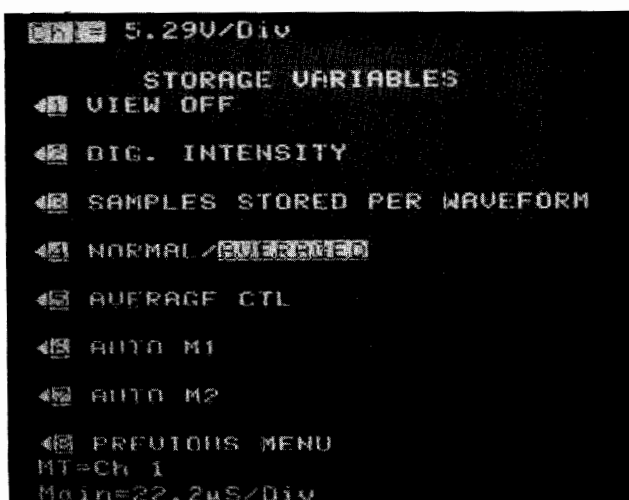

Setting the digitizer's operating modes is achieved through a series of menus. Menu functions are also programmable.

OSCILLOSCOPES

Oscilloscope Measurement System

Models 1980A/B (Cont.)

In either acquisition mode, the waveform acquisition window is defined by the main, delayed, or intensified horizontal display mode. In main or delayed mode, the full ten displayed divisions are digitized and stored. In the intensified mode, the intensified marker is digitized and displayed as a full ten divisions for immediate expansion of a critical portion of a waveform. Digitizing of the intensified marker makes it easy to define the portion of a signal to be acquired with a full 501 points of resolution.

Noise Reduction

In the repetitive mode, averaging can be selected to capture repetitive signals containing random noise. The number of averages per data point can be selected in a 2, 4, 8, 16, 32, or 64 sequence. In the single-shot mode, noise reduction is achieved by selecting a 1 MHz low pass filter.

Waveform Display

Real time waveforms including trigger view can be displayed along with either or both stored waveforms. With a two-channel expansion module installed, a total of seven (four real time, two stored, and trigger view) different waveforms may be displayed simultaneously. Also, stored waveform intensities may be adjusted independent of real time trace or character intensities for added viewing convenience.

Cursors

One or two cursors may be activated on each of the stored waveforms with voltage and time values displayed on the CRT. With one cursor active, a voltage value with respect to signal ground is displayed along with a time value representing the time from main sweep start to the cursor position. With two cursors active, delta time and delta voltage values between cursors are displayed.

Local Operation

Full control of the digitizer is available from the front panel by entering the 1980 menus. The digitizer has three comprehensive menus for selection of control functions such as sample density, averages per data points, cursor positioning, and waveform storage and display.

Automatic Operation

All of the digitizer capabilities can be controlled through the HP-IB interface by a computer which makes completely automatic signal acquisition and analysis possible. Because of the internal configuration of the 1980, the 19860A uses the system HP-IB interface and does not require a separate address which simplifies programming. In addition, the digitizer can transfer waveform data in either ASCII or Binary format to optimize data transfer and computation times for different controllers. Waveform data can also be sent from a controller to the 1980 for display as a reference or limits.

Feature ROMs

Two Feature ROMs are available to aid measurement capabilities. Model 19811A Plot/Sequence ROM provides a convenient method of obtaining records of waveforms and performing redundant measurements. The 19811A contains two separate programs, one plots waveform data from a 19860A digital waveform storage memory to HPGL "listen only" plotters without the need for a controller and the other directs the 1980A/B to perform sequential operations.

The plot program talks directly to an HPGL listen only plotter over the HP-IB interface when the 1980A/B is in the talk only mode. Operation of the plot program is accessed through the 19811A menu which allows waveforms stored in memory one or two, a graticule, and measurement parameters to be plotted for permanent record. Cursor locations may also be plotted to highlight points on complex waveforms.

The sequence portion of the ROM provides the capability of storing sequences of 1980A/B keystrokes. These sequences are then recalled by pressing a key on any of the 10080 series probes. Sequences can be programmed to set up the 1980/19860A system for repetitious measurements which reduces the possibility of setup errors while reducing total test time. For example, a program could include a series of keystrokes to set up the front panel for displaying a signal, digitize and store the signal, and then, using the plot program, output the stored waveform to a plotter. All of this automated measurement capability is accomplished by pressing one button on the oscilloscope probe. If the digital waveform storage capability is not added to a 1980A/B, the sequencing capability is available in the Model 19810A Sequence ROM.

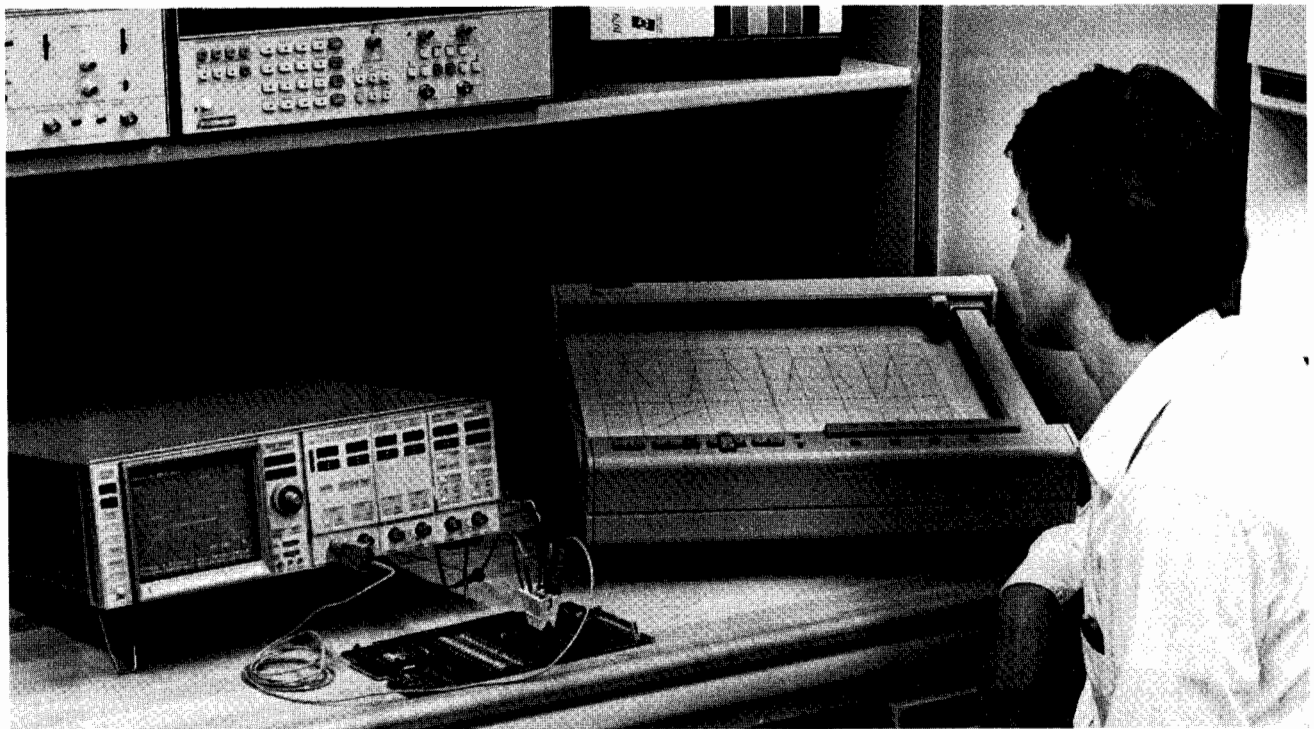

Design engineers can obtain multiple color hard copy by using the 19811A Plot/Sequence ROM. No computer is required.

Automatic Test Systems

The 1980/19860A system can greatly improve the efficiency of test systems by completely automating time domain measurements. This fully programmable system can be set up to acquire a signal, digitize it, and transfer it to a computer for automatic analysis to provide complete answers without operator intervention. A series of standard signals may be digitized and stored in a computer to build a library of references for automatic testing. Now, as tests are performed, signals are automatically compared in software.

Test procedures are easily developed because the 1980 uses a "learn string" to define all setup information. All that is required is to store a reference waveform along with the learn string that was used to set up the instrument. When the test is performed, the stored information is simply sent back to the 1980 with test written on the CRT to explain the adjustments.

Semiautomatic Testing

In applications where operator interaction is necessary, such as circuit setup, calibration, or troubleshooting, the programmable 1980/19860A capabilities can improve efficiency by eliminating operator front panel setup time and possible errors. A controller can set

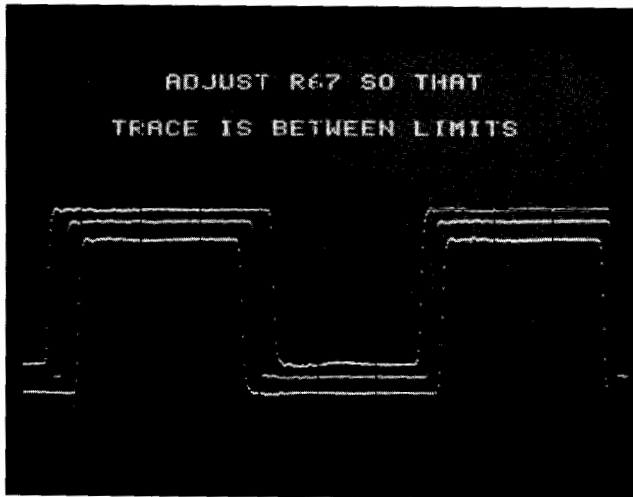

Operators can easily set the response of complex waveforms within specified limits.

up front panel controls and write a reference waveform with text on the CRT to direct an operator through a calibration sequence. The operator only has to make circuit adjustments so that a real time waveform is positioned between two reference waveforms. All of the information for a test, instructions, reference waveforms, and front panel setup, can be stored in a data base on tape or disc files.

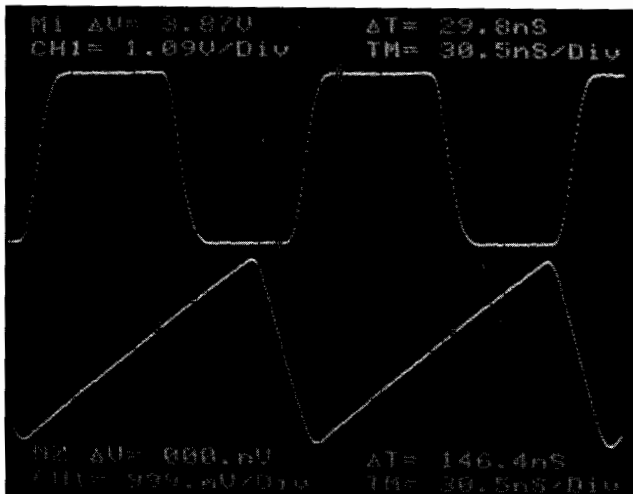

Cursors may be manually or automatically set to assist the operator, or read by a computer to aid in computation.

Furthermore, the 1980 front panel controls can be redefined in a programmable station. For example, the rotary control could be redefined to control the adjustment of another instrument as directed by instructions on the CRT. In a similar fashion, the soft keys could be redefined with the appropriate instructions adjacent to them to control the modes of operation of other instruments in a programmable system.

The start and stop cursors can also be used to improve measurement efficiency by taking advantage of operator interaction. For example, after a waveform is captured, the operator can position the cursors on critical points of a waveform that would normally require considerable controller software to define automatically. The cursor positions can then be read by the controller with the necessary computations quickly accomplished.

Bench Operation

In bench applications with a controller, an engineer can easily develop and maintain a data base to log the results of design changes. When combined with other programmable instruments, long tests can be automatically accomplished over night or a weekend to provide circuit characterization. With a plotter, graphs of waveforms can be easily maintained to record any changes in circuit response with design changes. Also, with the appropriate controller software, answers to frequent measurements can be obtained with the press of one of the 1980 soft keys.

Without a controller, the 1980/19860A can be used as a traditional oscilloscope with the added benefits of the easy-to-use front panel and software features. The Autoscope capability acquires a signal with the press of one key reducing the time for initial instrument setup. Frequently used front panel setups can be saved in eight local registers and quickly recalled to reduce measurement time and improve productivity. Slow repetition rate fast signals can be captured and displayed as bright, nonfading signals by the digital waveform storage capability.

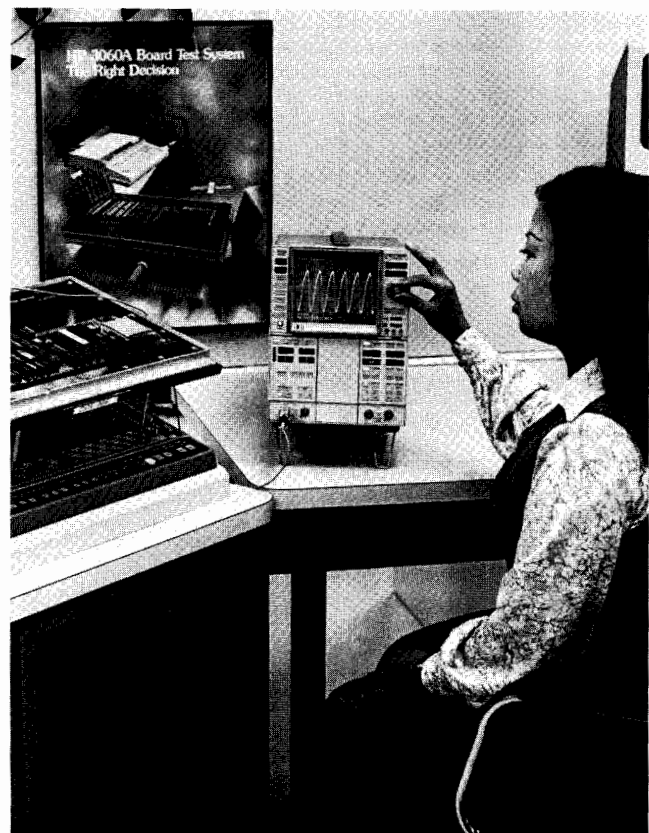

The 1980 System can be used with board test systems to perform parametric tests and align the circuit under test.



1980A/B Specifications

Operating Modes

Voltage vs time (V vs T); channel 1 vs 2 (1 vs 2); monitor mode for logic state display with HP Model 1607A (X • Y • Z).

Vertical Display Modes (V vs T)

Channel 1; channel 2; channels 1 and 2 displayed on alternate sweeps (ALT); channels 1 and 2 displayed by switching between channels at approx 400 kHz rate with blanking during switching (CHOP); automatic selection of alternate for sweep speeds > 1 ms/div and chop for sweep speeds ≤ 1 ms/div (AUTO-CHOP/ALT); channel 1 plus 2 algebraic addition (1 + 2), channel 1 and/or 2 may be inverted; and either main or delayed trigger signal.

Vertical Amplifiers (2)

Bandwidth: 3 dB down from a 5 div reference signal (0 to +40°C).

DC coupled: dc to 100 MHz in 50Ω and 1 MΩ input modes.

AC coupled: < 10 Hz to ≥ 100 MHz.

Bandwidth limit: limits upper bandwidth to approx 20 MHz.

Input coupling: ac, dc, 50Ω (dc), ground. Ground position disconnects input connector and grounds amplifier input.

Input RC: ac or dc, 1 MΩ ± 2% shunted by approx 16 pF; 50 ohm (dc), 50 Ω ± 3%.

Maximum input voltage: 50 ohm, 5V rms; 1 megohm, ac or dc coupled, 250V (dc + peak ac) at ≤ 1 kHz.

Deflection factor: range, 2 mV/div to 10 V/div; ± 3%, 3 digits of resolution.

Vertical position: range, baseline can be adjusted ± 15 major div from center graticule line (possible 10 div off screen); accuracy, ± (2% of reading + 0.3 major div).

ΔV (Channel 1 or 2): range, ± 15 times the deflection factor selected for that channel; accuracy, ± 4% (for a Δ ≤ 10 major div).

Channel 1 + 2

Amplifier: bandwidth and deflection factors are unchanged.

Differential (Channel 1-2 or Channel 2-1): CMR is at least 20 dB from dc to 20 MHz with common mode signal amplitude equivalent to 10 div and one channel adjusted for optimum rejection.

Trigger view: displays internal or external trigger signal for either main or delayed sweep.

Horizontal Display Modes (V vs T)

Main, Main Intensified, Delayed, and Dual. Dual simultaneously displays main intensified and delayed sweep.

Main and Delayed Time Bases

Range: 5 ns/div to 1 s/div; 3 digits of resolution.

Accuracy*

Speed	Accuracy*
5 ns/div to 9.99 ns/div (center 8 div)	± 3%
10 ns/div to 9.99 ms/div (first 10 div)	± 3%
10 ms/div to 1 s/div (first 10 div)	± 4%

*Within ± 10°C of the temperature at which the instrument was calibrated. For temperatures beyond the ± 10°C range and within 0 to +55°C, add 1% and 2% from 0.5 s/div to 1 s/div.

Sweep Delay

Time delay: range, 0 to 9.9999 s; resolution, displayed, 5 digits; HP-1B, 100 ps at any delay, possible 11 digits.

Accuracy*

Sweep Speed	Delay or time Interval	
	< 200 μs	≥ 200 μs
5 ns/div to 9.99 ns/div	± (2 ns + 0.1% of reading)	± (0.05% of reading)
≥ 10 ns/div	± (2 ns + 0.1% of reading + 1% of dly'd s/div x 10 div)	± (0.05% of reading + 1% of dly'd s/div x 10 div)

*Within one hour of a Delay Self-Calibration and in constant ambient temperature.

Delay jitter: 0.002% of delay time; at 10 MHz ± 10 kHz, 0.01% of delay time.

Time interval (ΔT): in Intensified, Dual, or Delayed Horizontal Display modes, a zero time reference can be set anywhere in the delay range and a Δt measurement made from that point.

Resolution, Accuracy: same as Time Delay.

Frequency (1/ΔT): calculates and displays reciprocal of time interval measurement; resolution, same as ΔT. As frequency increases, insignificant digits are truncated; accuracy, same as Time Delay.

Digital delay: range, 0 to 10⁶ - 1 events; resolution, 1 event; maximum rep rate, 15 MHz with a 50% duty cycle.

Triggering (Main and Delayed Time Bases)

Main Sweep

Triggered: specified level and slope generates a sweep.

Auto-triggered: baseline displayed in absence of a trigger signal; triggering is same as triggered above approx 10 Hz.

Single: sweep occurs once with same triggering as Triggered.

Delayed Sweep

Auto sweep after delay: delayed sweep starts at end of delay time.

Triggered sweep after delay: sweep can trigger after delay.

Digital delay: delayed sweep starts a specified number of events after start of main sweep.

Sources: selectable from channel 1, channel 2, enhancement module, or external. Line frequency triggering for main sweep only. Main and delayed independently selectable.

Internal Trigger Level

Range: ± 20 major divisions from center horizontal graticule line.

Resolution: 0.02 major divisions; coarse or fine slew rates.

Accuracy: ± (3% of reading + 0.4 major div).

External Trigger Level

Range: ± 1.2 V from ground reference; in ÷ 10, ± 12 V.

Resolution: ÷ 1, 2 mV; ÷ 10, 20 mV; coarse or fine slew rates.

Accuracy: ± (3% of reading + 40 mV); ÷ 10, ± (3% of reading + 400 mV).

Line Trigger Level

Range: ± 20 relative units.

Resolution: steps of 0.02; fine or coarse slew rates.

Slope: positive or negative slope within trigger signal range.

Sensitivity

Internal: < 10 mV/div, at least 1.4 div from dc to 25 MHz increasing to 3 div at 100 MHz; ≥ 10 mV/div at least 0.7 div from dc to 25 MHz increasing to 1.5 div at 100 MHz.

External: ÷ 10, at least 500 mV p-p from dc to 25 MHz increasing to 1.2 V p-p at 100 MHz; ÷ 1, at least 50 mV p-p from dc to 25 MHz increasing to 120 mV p-p at 100 MHz.

Coupling (internal and external): ac, attenuates signals < 10 Hz; dc, direct coupled; HF rej, attenuates signals above approx 35 kHz; LF rej, attenuates signals below approx 35 kHz.

External Trigger Inputs (Main and Delayed)

Input RC: ac or dc, 1 MΩ ± 2% shunted by approx 15 pF; 50Ω (dc), 50Ω ± 3%.

Maximum input voltage: 50Ω (dc), 5 V rms; 1 MΩ, ac or dc coupled, 250 V (dc + peak ac) at ≤ 1 kHz.

1 vs 2 Operation

Bandwidth: Y-axis (channel 1), same as channel 1 in V vs T; X-axis (channel 2), dc to 4 MHz.

Phase difference: ≤ 3° dc to 100 kHz.

Deflection factors: same as Vertical Amplifiers.

Cathode-Ray Tube and Controls

Type: post-accelerator, approx 22 kV accelerating potential, aluminum P31 phosphor.

Graticule: 10 x 10 div internal graticule; 0.2 subdivision markings on major horizontal and vertical axes; 10 x 12 cm display area.

Trace and character intensity: adjustable in relative steps of 1 from 0 to 99.



General

Bus Compatibility: as defined in IEEE Std 488-1978 is SH1, AH1, T5, TE0, L3, LE0, SR1, RL1, PP0, DC0, DT1, C0, and E2.

Power: 100, 120, 220, 240 Vac, +5 to -10%; 48 to 440 Hz; 300 VA max with expansion module and plug-in ROMs, standard, 200 VA max.

Weight: net, approx 18.2 kg (40 lb); shipping, approx 24.1 kg (53 lb).

Dimensions: (1980A) 278 H x 213 W x 534 mm D (10.9 x 8.4 x 21.4 in.). (1980B) 143 H x 427 W x 543 mm D (5.6 x 16.8 x 21.4 in.).

Operating environment: temperature, 0 to +55°C; humidity, to 95% relative at +40°C; altitude, to 4600 m (15000 ft); vibration, vibrated in three planes for 15 min each with 0.38 mm (0.015 in.) excursion, 10 to 55 Hz.

Accessories furnished: one blue light filter HP P/N 01980-02701; one 2.3 m (7.5 ft) power cord; one expansion module panel cover, HP P/N 01980-24106; two operating/programming manuals; one service manual; one binder with divider tabs; two 10081A, 10:1 divider probes approx 2 m (6 ft) long.

1950A Specifications

Vertical Display Modes

Channel 3 and 4 independently selected; channel 3 vs 2; channel 3 + 4; either or both channels may be inverted.

Vertical Amplifiers

Bandwidth: same as 1980.

Input RC: same as 1980, channels 1 and 2.

Deflection factors: 2mV/div to 10 V/div, $\pm 3\%$, 3 digit resolution.

ΔV (Channel 3 or 4): same as 1980, channels 1 and 2.

General

Operating environment: same as 1980A/B.

Weight: net, approx 1.5 kg (3.3 lb); shipping, 2.2 kg (4.8 lb).

Power: supplied by 1980.

Accessories furnished: one operating and service manual; two 10081A, 10:1 divider probes, approx 2 m (6.6 ft) long.

19860A Digital Waveform Storage Specifications

Vertical

Analog bandwidth: dc to 100 MHz; ac coupled lower limit is <10 Hz; 3 dB down from a 5 div reference; 0 to 40°C.

Acquisition window: $> \pm 4.5$ div from center horiz graticule line.

Matching of data to CRT graticule lines:¹ $\pm 2\%$ of full scale.

Matching of digitized to real time traces:¹

Sine Wave, Percent of Full Scale		
10 Hz	1 kHz	1 MHz
$\pm 1.5\%$	$\pm 1.5\%$	$\pm 2.5\%$

Excludes first data point. In repetitive mode, trigger rep rate must be 1 Hz or faster. In single sweep mode, trigger must occur within 1 s of digitize command, otherwise exclude first five data points. Data for this specification is acquired using the Auto-Cal default mode of a full Auto-Cal.

Absolute accuracy of data: \pm (accuracy of vertical channel + matching of digitized trace to real time trace + matching of data to graticule line).

DC offset: <0.2 div from real time trace at time of data acquisition.
¹Full scale is ten divisions.

RMS noise²

	2 mV/div to 9.99 mV/div	10 mV/div to 10 V/div
Normal	0.75% of fs	0.5% of fs
8 Averages or Filtered	0.4% of fs	0.25% of fs

²Measured by grounding the vertical input, digitizing, and calculating the RMS value of the data.

Horizontal

Acquisition window: Main Horizontal Display mode (Main s/div x 10 div); in Intensified and Delayed (Delayed s/div x 10 div). In Intensified and Delayed, the acquisition window can be delayed 0 to 9.9999 s from Main trigger point.

Time offset from real time trace: $-(25 \pm 5$ ns).

Timing accuracy: $\pm (2$ ns + 0.2% of the acquired time window).

Jitter: 0.002% of delay time + 1 ns; at 10 MHz ± 10 kHz, 0.01% of delay time + 1 ns.

Operating Characteristics

Repeatability of data: approx 2% for waveforms acquired within 8 hours and within 20°C to 30°C. To optimize repeatability of waveform data, use either a minimum of 8 averages or filtered mode, for signals <100 Hz use dc or 50 Ω input.

Vertical resolution: 10 bits, approx 0.1% of full scale.

Auto-Cal: pre-acquisition calibration of sampling efficiency that also sets offset and gain data correction factors. Offset and gain factors are used for post-acquisition data correction to match a digitized trace to a real time trace.

Sample density: selectable 1, 3, 6, 11, 21, 51, 101, 251, 501 points at any sweep speed.

Minimum time between points: repetitive, 100 ps, clocked by 1980 delay generator; single-shot, 19.8 μ s, clocked by 1980 processor clock.

Acquisition mode: repetitive, 999 μ s/div to 5 ns/div, two sweeps per point; single-shot, 1 s/div to 1 ms/div, one sweep per waveform.

Averaging: each sample point may be averaged 2, 4, 8, 16, 32, or 64 times in repetitive mode to reduce noise; N + 1 sweeps required per point, where N = number of averages.

Filter: approx 1 MHz low pass filter selectable in single-shot.

Cursors: start and stop cursors for memories (M1 and M2) to measure voltage from center graticule line, time from main trigger point, or ΔV and ΔT measurements on stored waveforms.

General

Operating environment: same as 1980B.

Weight: net, 0.4 kg (13 oz); shipping, 0.9 kg (2 lb).

Options

150: Model 1950A Expansion Module

Add \$2100

810: Model 19810A Sequence ROM

Add \$400

811: Plot/Sequence ROM

Add \$500

860: Digital Waveform Storage

Add \$2750

907 (1980B): front handle kit (P/N 5061-0089)

Add \$32

908 (1980B): rack flange kit (P/N 5061-0077)

Add \$25

909 (1980B): rack flange and front handle kit

Add \$55

(P/N 5061-0083)

910 (1980): adds two operating/programming manuals, a service manual, and a binder with divider tabs

Add \$150

910 (1950A): adds one operating/service manual

Add \$50

910 (19860A): adds one operating/service manual

Add \$50

914 (1980): adds one operating/programming manual, a binder and divider tabs

Add \$75

Ordering Information

1980A Oscilloscope Measurement System (Cabinet)

\$9000

1980B Oscilloscope Measurement System (Rack)

\$9000

1950A 100 MHz, 2-Channel Expansion Module

\$2100

19810A Sequence ROM

\$400

19811A Plot/Sequence ROM

\$500

19860A Digital Waveform Storage

\$2750

OSCILLOSCOPES

100 MHz Delta Time, Time Interval Averaging

Models 1740A, 1742A, 1743A

- Delta time measurements
- Optional built-in DMM for increased accuracy & flexibility
- Dual channel, 5 mV/div to 100 MHz
- 3rd channel trigger view and selectable input impedance

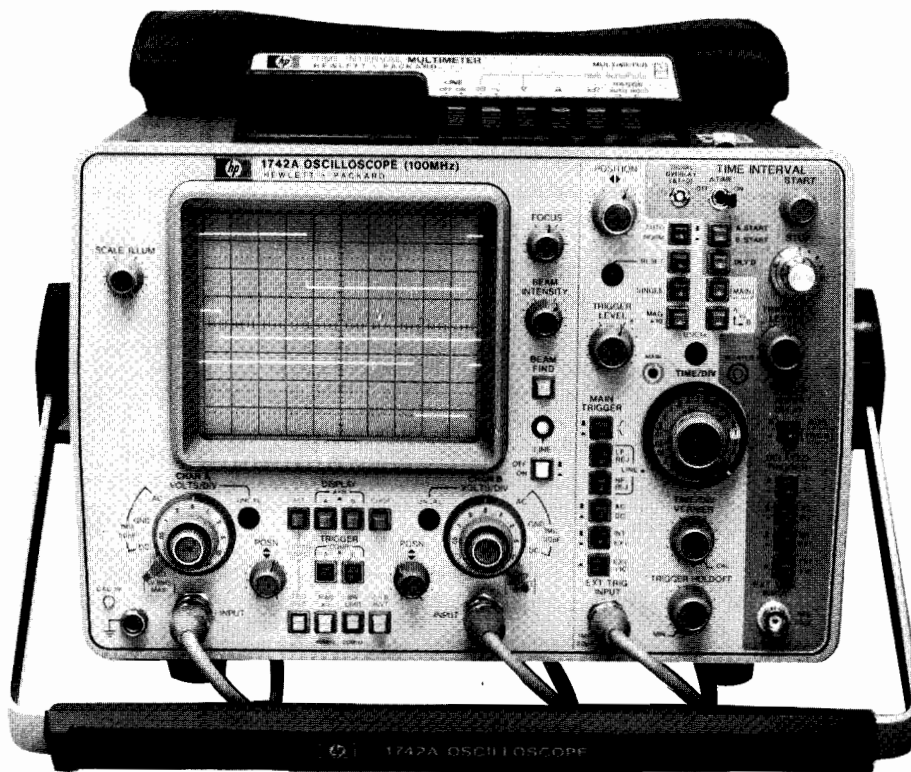

1742A Opt 034

Description

Hewlett-Packard's 1740 series of 100 MHz, dual channel oscilloscopes offer the high performance necessary to meet the demanding requirements of both laboratory and field applications. Familiarization with the logical, human engineered operating controls is quickly accomplished with color-coded pushbuttons and front panel face plate. All main sweep controls are located in a light gray background with delayed sweep controls in a dark gray background for easy differentiation. Pushbuttons are color-coded for fast recognition: blue for display functions, green for trigger functions, and white for special functions.

Several operating features that add to the measurement versatility include third channel trigger view, a times five vertical magnifier for two channel, low level measurements, and selectable input impedance. A selection of options is also available to add measurement capability and versatility to the instrument's extensive measurement set.

Standard Features 1740A, 1742A, 1743A

Large CRT

The large 8 x 10 cm CRT has a small, well-defined spot size with 15 kV accelerating potential that provides sharp, bright traces over the fully specified display area. Illumination of the nonparallax internal graticule for trace photos is achieved with an internal flood gun.

Third Channel Trigger View

Third channel trigger view allows the internal or external trigger signal to be displayed with the press of a button. The ability to display the external trigger signal without physically connecting it to a vertical channel input makes it easy to check the shape of the waveform and verify that the trigger threshold is not set to portions of a

waveform containing irregularities and reflections. The three-channel display available with trigger view is extremely useful in dual channel timing applications. Timing measurements can be made in reference to the displayed trigger signal, which has a specified delay of ≤ 3.5 ns relative to the vertical channels.

Triggering

Stable internal triggering to greater than 100 MHz is achieved with only one division of vertical deflection. A stable display regardless of changes in position, vernier, or polarity controls is maintained because the internal trigger sync takeoff is immediately after the attenuator which eliminates loss of a triggered display. External triggering only requires 100 mV for triggering to 100 MHz and 50 mV to 50 MHz. An extensive selection of trigger conditioning controls assures that the display is triggered by the desired signal.

Vertical Amplifiers

Vertical deflection factors from 5 mV/div to 20 V/div assure that the majority of signals can be easily displayed. For low level signals, a times five magnifier offers dual channel deflection factors of 1 mV/div and 2 mV/div to 40 MHz.

Selectable Input Impedance

Front panel selection of 50 ohm and 1 megohm input impedances offers maximum measurement flexibility and convenience. The internal 50 ohm input typically exhibits superior pulse fidelity and lower reflections than an external 50 ohm load.

Serviceability

Calibration and service time is greatly reduced through the use of Hewlett-Packard developed integrated hybrid circuits which have few internal adjustments. Whenever possible, signals between boards are routed through an interface board which reduces service time and reassembly errors by eliminating many cables. The low

- Time interval averaged delta time measurements
- Semiautomatic triggered delta time measurements
- Dual channel, 5 mV/div to 100 MHz
- 3rd channel trigger view and selectable input impedance

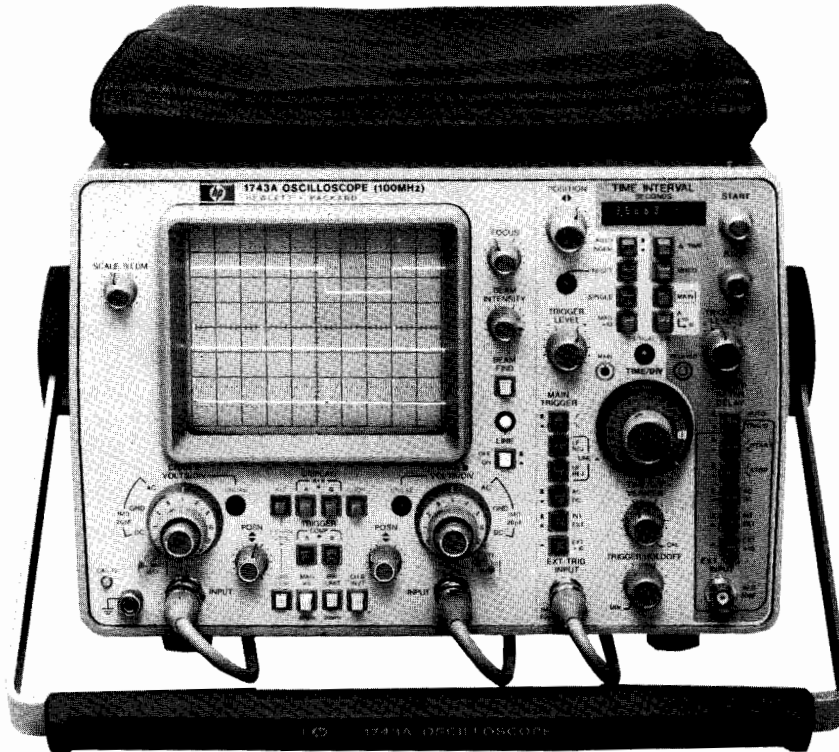

1743A



power requirement of these oscilloscopes eliminates the need for a fan or ventilating holes for convection cooling which reduces the internal accumulation of dust and dirt.

Options

Digital Multimeter (1740A, 1742A)

This Option 034/035 is a 3½ digit autoranging DMM that adds the five most common measurements: ac and dc voltage, ac and dc current, and resistance. In the 1742A, the DMM also provides a direct readout of delta time measurements.

TV Sync (1740A, 1742A)

The TV Sync Option 005 adds the circuits and controls necessary for triggering on composite video signals. Vertical inputs supplied by this option are compatible with video outputs, ensuring maximum stability and fidelity of video signals. Detailed examination of lines and test signals is easily accomplished with the versatile triggering and viewing capabilities.

Logic State Display (1740A, 1742A, 1743A)

The Logic State Display Option 101 combines the real time state display of an HP Model 1607A Logic State Analyzer with the oscilloscope measurement sets. This option replaces the A vs B mode with a state display mode for one button switching between state and time domain measurements.

Time Interval Measurements

Model 1740A. Time interval measurements are accomplished using the familiar single marker delayed sweep. Accurate timing measurements are achieved using the delayed sweep and the helical delay control.

Model 1742A. Time interval measurements with the 1742A are made using the Hewlett-Packard developed two marker system known as delta time which simplifies time interval measurements while improving accuracy and resolution. In the delta time mode, start and stop intensified markers are alternately displayed on the main intensified sweep, and the interval between the markers is read directly on the optional DMM or on the calibrate helical delay dial, or the time interval is available as a rear panel scaled voltage output compatible with most DVM's. Maximum accuracy is obtained by switching to the delayed sweep mode and overlapping the expanded

waveforms takes advantage of the increased resolution available in delayed sweep.

Model 1743A. The 1743A incorporates a second generation delta time system based on a 100 MHz crystal oscillator rather than the traditional analog reference ramp. A time interval averaging technique increases both the accuracy and resolution of repetitive waveform measurements. This technique measures the time interval by accumulating counts from the 100 MHz crystal oscillator with a fundamental accuracy of ± 1 clock period (± 10 ns for a 100 MHz clock). However, by using a time interval averaging technique, the resolution of the measurement is increased by \sqrt{N} , where N is the number of averages. At the three fastest sweep speeds, 10,000 intervals are averaged to produce a measurement with a 100 ps resolution. The averaged time interval measurement is directly displayed on a five digit LED readout.

Time interval measurements relative to the leading edge of the first pulse in the main sweep display can be made with the 1743A. This first pulse measurement capability permits measurements between the trigger signal and the other two channels. In the trigger view mode, the start marker is on the trigger channel with the stop marker on each of the two channels at the same point in time. This allows timing measurements from the leading edge of an asynchronous signal, such as a strobe or flag, to resulting activity on channels A and B.

This crystal referenced timing capability allows the sweep vernier to be used out of its detent position without uncalibrating the LED display. For example, the vernier can be used to set the graticule lines to represent clock periods with measurements of other signals then made in relation to the "clock" signal.

The sweep vernier can also improve display resolution by up to three times. With the vernier in detent, the resolution of a full screen display is a maximum of one part in 50,000, and, with the vernier full ccw, full screen resolution is a maximum of one part in 150,000. This increased resolution is obtained by using a faster main sweep speed and adjusting the vernier to obtain the desired display. For example, by switching from a 1 μ s/div range to a 0.5 μ s/div range the last digit of the five digit display becomes hundreds of picoseconds instead of nanoseconds. The same display of the 1 μ s/div sweep can now be obtained on the 0.5 μ s/div sweep by adjusting the sweep vernier.

OSCILLOSCOPES

Variable Persistence/Storage

Models 1741A, 1744A

- 200 cm/ μ s variable persistence & stored writing speed
- Minimum blind time, auto-intensity
- Dual channel, 5 mV/div to 100 MHz
- 3rd channel trigger view and selectable input impedance

1741A Opt 034



1741A, 1744A Variable Persistence/Storage

Hewlett-Packard Variable Persistence/Storage Oscilloscopes provide a "one oscilloscope" solution to the wide variety of measurements encountered daily. The versatility results from the multitude of operating modes available; starting with minimum persistence, which approximates conventional operation, through continuous persistence settings, all the way to automatic storage. The adjustable persistence control provides the ability to match signal and persistence characteristics resulting in excellent display characteristics over a wide range of conditions.

Applications

These oscilloscopes provide a clear display of virtually any signal; however, they are especially useful in certain applications. Low repetition rate signals at fast sweep speeds produce very low light output on conventional CRTs and normally require the use of a viewing hood to obtain a viewable display. The variable persistence mode solves this problem by integrating several sweeps to amplify the light output, thereby producing bright, clear traces. This "light-integrating" capability is also useful in eliminating flickering displays, which are the result of low repetition rates and slow sweep speed signals. These signals are annoying to view and even more difficult to measure; however, the display is improved by matching signal and persistence characteristics.

Single-shot events are also captured easily by using the auto-store mode, which, once set, will wait and capture a sweep after the first trigger event. During operation of the oscilloscope, any display on the CRT can be saved at the touch of a button, no matter what mode the instrument is in.

Writing Speed and Blind Time

In all Hewlett-Packard storage oscilloscopes, the advanced technology used allows signals to be captured at the maximum writing speed in both variable persistence and single-shot modes (1741A-200 cm/ μ s; 1744A-1800 cm/ μ s; 1727A-2000 cm/ μ s). These fast writing

speeds are achieved without reduced scans or excessive blind times. Operating in the variable persistence mode, high speed signals can be scanned without transfer or erase time (typically 1 second) necessary in other storage techniques. The probability of displaying a random event is increased by decreasing the blind time by a factor of 1000 or more in most situations.

A Comparison - Fast Writing Modes

1. HP's Variable Persistence Mode

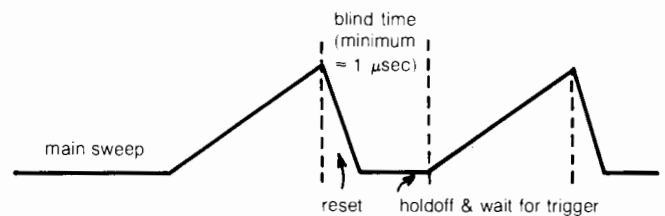

2. Transfer Techniques Not Used in HP Variable Persistence/Storage Oscilloscopes

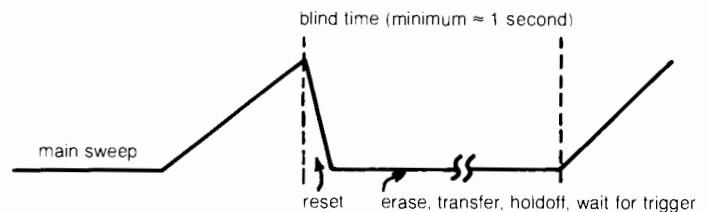

- 1800 cm / μ s variable persistence & stored writing speed
- Minimum blind time, auto-intensity circuit
- Dual channel 5 mV / div to 100 MHz
- 3rd channel trigger view and selectable input impedance

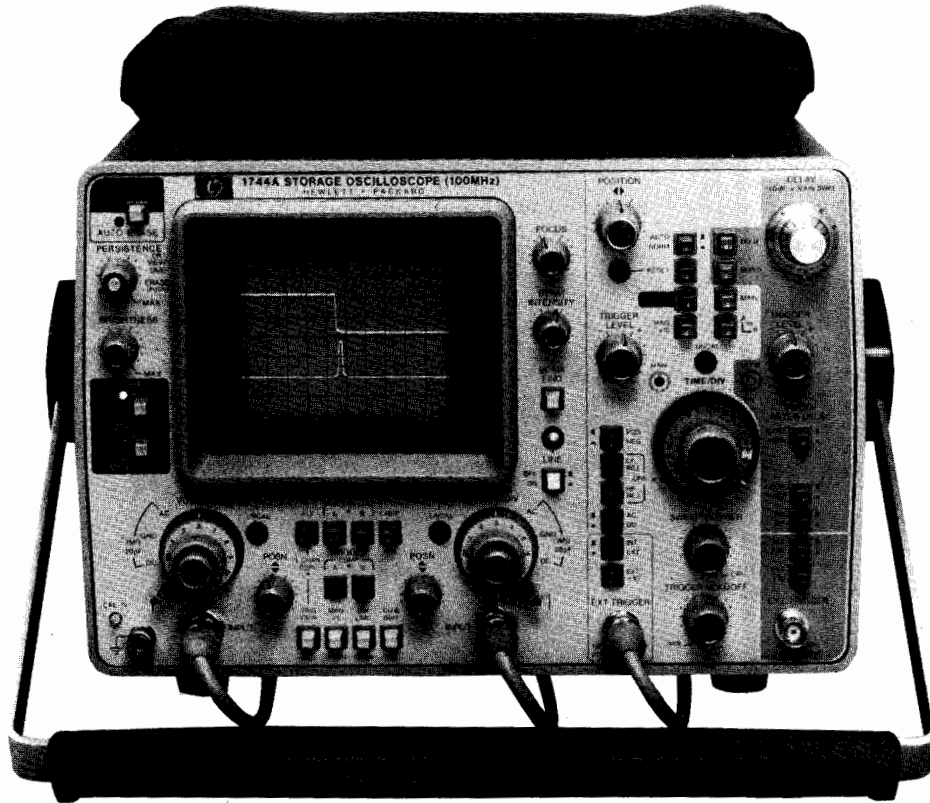

1744A

1741A, 1744A 1727A Operation

An auto-intensity circuit in all of these variable persistence/storage oscilloscopes simplifies operation. This circuit permits sharp, flicker-free, non-blooming traces to be obtained in the variable persistence mode under almost all operating conditions. There is a variety of settings available in the variable persistence mode; however, there is an easily set reference position that will provide a viewable trace: Intensity—max, Persistence—min, Brightness—min. From this position, Intensity can be decreased and Persistence can be increased as necessary.

In addition to the variable persistence mode, storage LEDs provide positive identification of storage operating modes. The auto-erase mode periodically takes individual "snapshots" of an input signal. In this mode, Persistence is internally set to maximum and the persistence control regulates how frequently a new "snapshot" is captured and displayed when two or more channels are displayed. The required number of sweeps are captured before a new cycle is initialized. This mode offers "hands-off" operation for probing circuits and a convenient method of quickly setting the focus and intensity for single-shot events.

The auto-store mode makes single-shot events easy to capture and reduces the possibility of recording the wrong event by automatically switching to the normal trigger mode. The oscilloscope automatically switches from a "write" mode to a

"store" mode after the sweep of the single-shot event for maximum trace retention time. A "store" LED indicates that the event is captured and one press of the Store/Display button displays the stored trace.

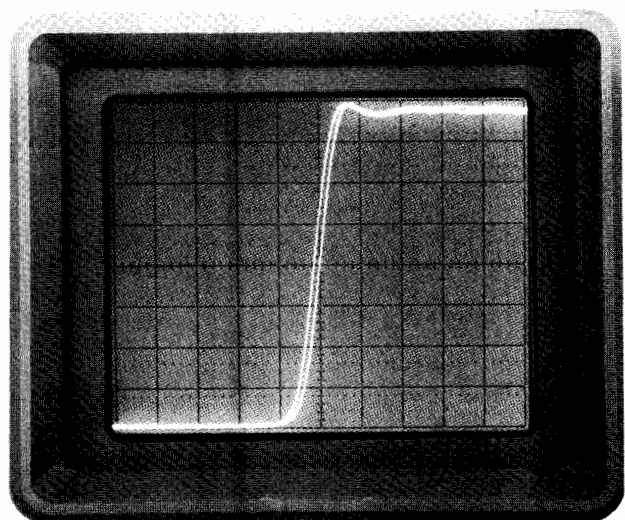
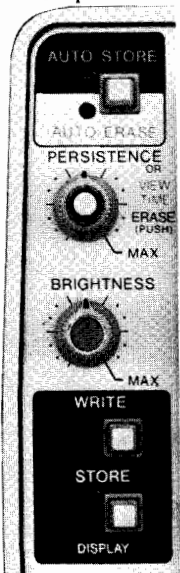

Exceptionally fine trace in the variable persistence mode permits high resolution timing measurements as shown with this dual trace, alternate sweep display at a sweep speed of 5 ns/div.



1741A Auto-Camera Option

The Auto-Camera Option 003 combines with Model 1741A to form a powerful method of obtaining photographic records, especially in long-term monitoring applications where hours of "babysitting" time can be saved. Setup involves mounting a Model 197B camera on the 1741A and selecting the auto-store mode. When the trigger signal is received, the oscilloscope sweeps and switches automatically to the store mode. Control circuits then command a display of the stored trace and actuate the camera shutter. After the first exposure of the waveform, the 1741A executes an erase cycle and, at the same time, the camera takes a second exposure to superimpose the graticule on the photograph.

Optional Parametric Measurements

A new dimension of measurement capability is added to the 1741A with Option 002, triggered A vs B mode. Many non-time related displays commonly encountered in engineering problems, such as the Lissajous pattern, are clearly and accurately displayed. Option 002 adds a variable delay line in the horizontal axis which eliminates phase error and enables the 1741A to produce matched phase response up to the 5 MHz bandwidth of the horizontal section.

The display of parametric measurements is also enhanced by using main sweep to window several cycles of an event and then selecting delayed sweep, A vs B mode to examine each cycle. This triggered technique eliminates the bright spots caused by inactivity in the A vs B mode and removes any confusion created by having unnecessary information on the display.

Expansion Storage 1744A

The ability to capture signals at the maximum bandwidth of the 1744A vertical deflection system is achieved with expansion storage CRT technology. This fast writing speed is achieved by combining a miniature precision storage mesh with an electronic lens system that magnifies and projects the stored image. The storage mesh is about one-fifth the size of the viewing screen and is capable of storing sharp waveform images. An electron cloud from a flood gun projects the image through the electronic lens system into the CRT phosphor for viewing. The extremely fast writing speeds provided by the expansion mesh technology are available in both variable persistence and storage modes. Operation is enhanced with an automatic focus circuit and maintains a crisp display with changes in intensity while an auto-intensity circuit helps to maintain a constant beam current to the storage surface over a wide range of sweep speeds.

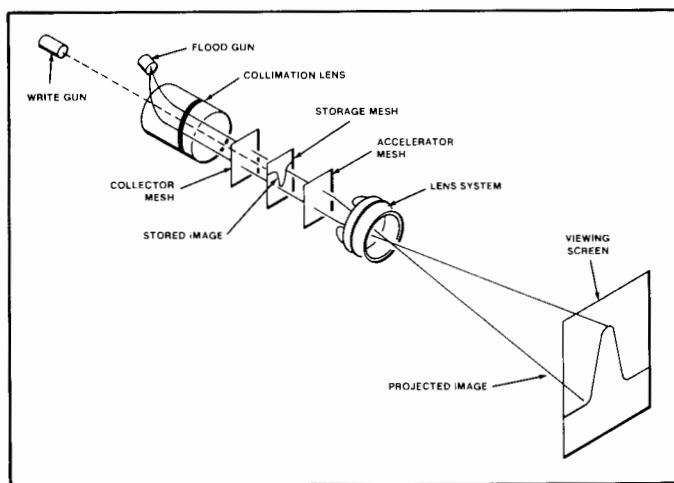

Expansion Storage CRT

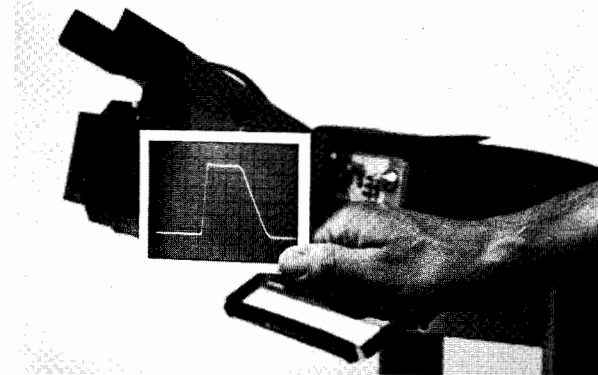

Long term monitoring of circuits to capture random events is simplified with the 1741A Auto-camera Option 003. You can set up the oscilloscope/camera, leave them unattended, and automatically capture single-shot events.

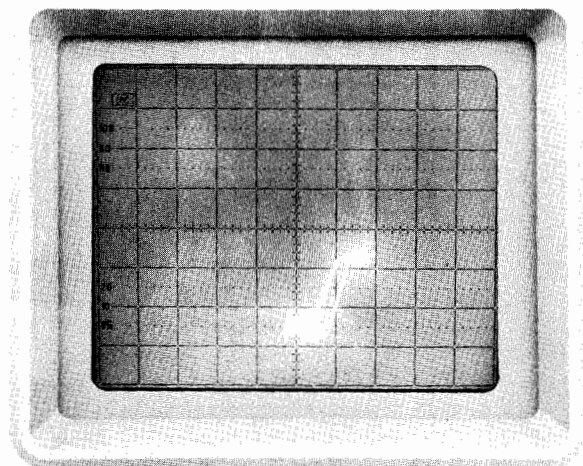

without triggered X, Y

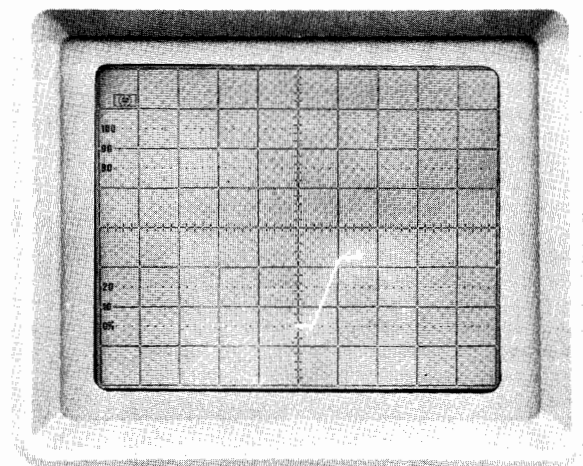

with triggered X, Y

1741A Triggered A vs B Option 002. The display of signals (top trace) in main sweep, A vs B mode shows total signal parameters. With delayed sweep A vs B, the display can be qualified (lower trace) to show only changing parameters which eliminates the bright dots caused by stationary values and confusion caused by unnecessary information.



1740A, 1741A, 1742A, 1743A, 1744A

Specifications

Vertical Display Modes

Channel A; channel B; A and B displayed alternately on successive sweeps (ALT); A and B displayed by switching between channels at ≈ 250 kHz rate with blanking during switching (CHOP); A plus B (Algebraic addition); and trigger view.

Vertical amplifiers (2) Bandwidth and Rise Time at all deflection factors from 0°C to +55°C.

Bandwidth: 3 dB down from 8 div reference signal; 3 dB down from 6 div reference signal for 1741A, 1744A.

DC-coupled: dc to 100 MHz in both 50Ω and 1 MΩ input modes.

AC-coupled: ≈ 10 Hz to 100 MHz.

Bandwidth limit: limits upper bandwidth to ≈ 20 MHz.

Rise time: ≤ 3.5 ns measured from 10% to 90% points of a 6 div (5 div, 1744A) input step.

Deflection Factor

Ranges: 5 mV/div to 20 V/div (12 calibrated positions) in 1, 2, 5 sequence, attenuator accuracy $\pm 3\%$.

Vernier: extends deflection factor to ≥ 50 V/div.

Polarity: channel B may be inverted.

Input coupling: selectable AC or DC, 50Ω (dc), or ground.

Input RC (selectable): AC or DC, 1 MΩ $\pm 2\%$ shunted by ≈ 20 pF; 50Ω, 50Ω $\pm 3\%$, SWR ≤ 1.4 at 100 MHz.

Maximum input: AC or DC, 250 V (dc + peak ac) or 500 V p-p at ≤ 1 kHz; 50Ω, 5 V rms.

A + B Operation

Amplifier: bandwidth and deflection factors are unchanged; channel B may be inverted for A-B operation.

Differential (A-B) common mode: CMR is at least 20 dB from dc to 20 MHz. Common mode signal amplitude equivalent to 8 div (6 div, 1744A) with one vernier adjusted for optimum rejection.

Vertical Magnification (X5)

Bandwidth: 3 dB down from 8 div (6 div, 1744A) reference signal.

DC-coupled: dc to ≈ 40 MHz; dc to ≈ 30 MHz for 1741A, 1744A.

AC-coupled: ≈ 10 Hz to 40 MHz; ≈ 10 Hz to 30 MHz for 1741A, 1744A.

Rise time: ≤ 9 ns, ≤ 12 ns for 1741A, 1744A (measured from 10% to 90% points of 8 div, 5 div 1744A, input step).

Deflection factor: increases sensitivity of 5 and 10 mV settings by a factor of 5 with max sensitivity of 1 mV on channels A and B.

Trigger Source

Selectable from channel A, channel B, composite, or line frequency.

Trigger View

Displays internal or external trigger signal. In Alternate or Chop mode, channel A, channel B, and the trigger signals are displayed. In channel A or B mode, trigger view overrides that channel. Internal trigger signal amplitude approximates vertical signal amplitude. Ext trigger signal deflection factor is 100 mV/div or 1 V/div in EXT $\div 10$. Triggering point is approx center screen. With identically timed signals to a vertical input and the EXT trigger input, trigger signal delay is ≤ 3.5 ns.

Horizontal Display Modes

Main, Δ time with channel A or B start (1742A, 1743A), main intensified, mixed (except 1743A), delayed, mag X 10, and A vs. B.

Main and Delayed Time Bases

Ranges

Main: 50 ns/div to 2 s/div (24 ranges) in 1, 2, 5 sequence.

Delayed: 50 ns/div to 20 ms/div (18 ranges) in 1, 2, 5 sequence.

Accuracy

Sweep Time/Div	*Accuracy		Temp Range
	X1	X10	
50 ns to 20 ms	$\pm 3\%$	$\pm 4\%$	0°C to +15°C
	$\pm 2\%$	$\pm 3\%$	+15°C to +35°C
	$\pm 3\%$	$\pm 4\%$	+35°C to +55°C

*Add 1% for 50 ms to 2 s ranges

Main sweep vernier: extends slowest sweep to at least 5 s/div.

Magnifier (X10): extends fastest sweep to 5 ns/div.

Calibrated Sweep Delay (except 1743A)

Delay time range: 0.5 to 10 X Main Time/Div settings of 100 ns to 2 s (min delay 150 ns).

Models 1740A, 1741A, 1742A, 1743A & 1744A (cont.)

Differential Time Measurement Accuracy

(Using one intensified marker and helidial control)

Main Time Base Setting	Accuracy* (+15°C to +35°C)
100 ns/div to 20 ms/div	$\pm (0.5\% \text{ of reading} + 0.1\% \text{ of fs})$
50 ms/div to 2 s/div	$\pm (1\% \text{ of reading} + 0.1\% \text{ of fs})$

*Add 1% for temperature from 0°C to +15°C and +35°C to +55°C.

Delay jitter: $< 0.002\%$ (1 part in 50 000) of max delay in each step from +15°C to +35°C; $< 0.005\%$ (1 part in 20 000) from 0°C to +15°C and +35°C to +50°C.

Differential Time Measurement Accuracy (1742A)

(Using Δ time dual intensified markers)

Main Time Base Setting	Accuracy* (+15°C to +35°C)		
	Opt 034/035	External DVM***	Helidial
100 ns** to 20 ms/div	$\pm (0.5\% \text{ of reading} + 0.05\% \text{ of fs})$	$\pm (0.5\% \text{ of reading} + 0.05\% \text{ of fs})$	$\pm (0.5\% \text{ of reading} + 0.1\% \text{ of fs})$
50 ms to 2 s/div	$\pm (1\% \text{ of reading} + 0.1\% \text{ of fs})$	$\pm (1\% \text{ of reading} + 0.1\% \text{ of fs})$	$\pm (1\% \text{ of reading} + 0.1\% \text{ of fs})$

*Add 1% for temperatures from 0°C to +15°C and +35°C to +55°C.

**On 100 ns/div range, specification applies after first cm of main sweep.

***Add DVM accuracy.

Time Interval (Δ Time) 1742A

Function: measures time interval between two events on channel A (A display); two events on channel B (B display); or two events starting from an event on either channel A or B and ending with an event on either channel A or B (alternate display).

Time interval output voltage: varies from 50 V to 100 mV full scale. Full scale output voltage can be determined by multiplying the number on the Time/Div dial by 10 V (e.g. 0.05 s, 0.05 ms, or 0.05 μ s per div gives 0.5 V output full-scale).

Stability (0°C to +55°C): short-term 0.005%. Temperature, $\pm 0.03\%/^{\circ}\text{C}$ deviation from calibration temperature range.

Crystal Referenced Δ Time (1743A)

Delay time range: 0 to 10 X Main Time/Div settings of 100 ns to 2 s.

Differential time measurement accuracy

Accuracy: $\pm 0.002\%$ of reading ± 1 count from +15°C to +35°C; $\pm 0.005\%$ of reading ± 1 count from 0°C to +15°C and +35°C to +55°C.

Time Resolution of ± 1 Count

Sweep Ranges/div	± 1 Count	Averages
0.1 μ s, 0.2 μ s, 0.5 μ s	± 100 ps	10 000
1 μ s, 2 μ s, 5 μ s	± 1 ns	1 000
10 μ s, 20 μ s, 50 μ s	± 10 ns	100
0.1 ms, 0.2 ms, 0.5 ms	± 100 ns	direct

Readout: 5 digit LED plus exponent.

Crystal Aging: 0.0005% per year.

Delay jitter: same as other 1740 series oscilloscopes.

Triggering

Main Sweep

Normal: sweep is triggered by internal or external signal.

Automatic: baseline displayed in absence of input signal. Above ≈ 40 Hz, triggering is same as normal.

Single: sweep occurs once with same triggering as Normal. Reset arms sweep and lights indicator. (1741A, 1744A) Single sweep is also initiated with Erase, sweep is armed after the erase cycle.

Internal: dc to 25 MHz on signals ≥ 0.3 div vertical deflection, increasing to 1 div vertical deflection at 100 MHz in all display modes (required signal level is increased by 2 when in Chop mode and by 5 when X5 vertical magnifier is used).

External: dc to 50 MHz on signals of 50 mV p-p or more, increasing to 100 mV p-p at 100 MHz (required signal level is increased by 2 when in Chop mode).

Delayed Sweep (Sweep After Delay)

Auto: delayed sweep starts at end of delay period.

Trig: delayed sweep armed and triggerable at end of delay period.

Internal: same as Main Sweep except 1743A is dc to 25 MHz on signals causing 1 div or more vertical deflection, increasing to 2 div of vertical deflection at 100 MHz.

External: same as Main sweep except 1743A is dc to 50 MHz on signals 100 mV p-p increasing to 200 mV p-p at 100 MHz.



External input RC: $\approx 1\text{ M}\Omega$ shunted by $\approx 20\text{ pF}$; max external input, 250 V (dc + peak ac) or 500 V p-p at $\leq 1\text{ kHz}$.

Level and slope: internal, at any point on positive or negative slope of displayed waveform; external, continuously variable from +1 V to -1 V on either slope of trigger signal, +10 V to -10 V in $\div 10$.

Coupling: AC, DC, LF REJ, or HF REJ.

Trigger holdoff (main sweep): increases sweep holdoff, all ranges.

Calibrated Mixed Time Base (except 1743A)

Dual time base in which the main time base drives the first portion of sweep and the delayed time base completes the sweep at the faster delayed sweep. Also operates in single sweep mode. Accuracy, add 2% to main time base accuracy.

A vs B Operation (deleted with Opt 101)

Bandwidth: channel A (Y-axis), same as channel A; channel B (X-axis), dc to 5 MHz.

Deflection factor: 5 mV/div to 20 V/div (12 cal positions) in 1, 2, 5 sequence; phase difference between channels, $< 3^\circ$, dc to 100 kHz (75 kHz, 1743A).

Cathode-ray Tube and Controls (1740A, 1742A, 1743A)

Type: 12.7 cm (5 in.) rectangular CRT, post accelerator, $\approx 15\text{ kV}$ accelerating potential, aluminized P31 phosphor.

Graticule: 8 x 10 div (1 div = 1 cm) internal non-parallax graticule, 0.2 subdivision markings on major horizontal and vertical axes and markings for transition time measurements. Internal floodgun graticule illumination.

Beam finder: returns trace to CRT screen.

Z-axis input (intensity modulation): +4 V, $\geq 50\text{ ns}$ wide pulse blanks trace of any intensity, usable to $\leq 10\text{ MHz}$ for normal intensity. Input R, 1 k Ω $\pm 10\%$. Max input $\pm 20\text{ V}$ (dc + peak ac).

Rear panel controls: astigmatism and trace align.

Cathode-ray Tube and Controls (1741A)

Type: 12.7 cm (5 in.) rectangular CRT, post accelerator, $\approx 7.5\text{ kV}$ accelerating potential, aluminized P31 phosphor.

Graticule: 8 x 10 div (1 div = 0.85 cm) internal, non-parallax graticule, 0.2 subdivision markings on major horizontal and vertical axes, with markings for transition time measurements. Graticule illumination is achieved with Persistence control set to min.

Beam finder: returns trace to CRT screen.

Z-axis input (intensity modulation): same as 1740A.

Operating modes: write, store, display, auto-store, auto-erase, and conventional (rear panel control).

Persistence: variable, $\approx 100\text{ ms}$ to 1 min; conventional, $\approx 40\text{ }\mu\text{s}$.

Writing speed, variable persistence and storage: $\geq 200\text{ cm}/\mu\text{s}$ (235 div/ μs) over center 7 x 9 div (with viewing hood).

Storage time: display mode, at least 10 s at 22°C; store mode, at least 30 s at 22°C.

Brightness: $\approx 170\text{ cd}/\text{m}^2$ (50 f) increasing to $\approx 340\text{ cd}/\text{m}^2$ (100 f) depending on brightness control setting.

Erase time: $\approx 300\text{ ms}$.

Rear panel controls: astigmatism, trace align, conventional push-button, and view time.

Cathode-ray Tube and Controls (1744A)

Type: 12.7 cm (5 in.) rectangular CRT, post accelerator, $\approx 10\text{ kV}$ accelerating potential, aluminized P31 phosphor.

Graticule: 8 x 10 div (1 div = 0.72 cm) internal graticule, 0.2 subdivision markings on major horizontal and vertical axes, with markings for transition time measurements. Graticule illumination is achieved with Persistence control set to min.

Beam finder, Z-axis input (intensity modulation): See 1740A.

Operating modes: write, store, display, auto-store, and auto-erase.

Writing speed, variable persistence and storage: $\geq 1800\text{ cm}/\mu\text{s}$ (2500 div/ μs) over center 6 x 8 div (with viewing hood).

Storage time: store mode, at least 30 s; view mode, at least 10 s; wait time, at least 60 s, at 22°C.

Persistence: variable (100 ms min).

Erase time: $\approx 300\text{ ms}$.

Rear panel controls: astigmatism and trace align.

General

Rear Panel outputs: main and delayed gates, 0.8 V to $\geq +2.5\text{ V}$ capable of supplying $\approx 5\text{ mA}$.

Amplitude Calibrator (0°C to +55°C)

Output voltage	1 V p-p into $\geq 1\text{ M}\Omega$ 0.1 V p-p into 50 Ω	$\pm 1\%$
Rise time	$\approx 0.1\text{ }\mu\text{s}$	
Frequency	$\approx 1.4\text{ kHz}$	

Power: 100, 120, 220, 240 V ac $\pm 10\%$; 48 to 440 Hz; 100 VA max.
Weight: (1740, 1742) net, 13 kg (28.6 lb); shipping 15.7 kg (34.6 lb). (1741, 1743, 1744) net 13.8 kg (30.5 lb); shipping 17.7 kg (39 lb).

Operating environment: temperature 0°C to +55°C; humidity to 95% relative humidity at +40°C; altitude, to 4600 m (15 000 ft); vibration, vibrated in three planes for 15 min. each with 0.254 mm (0.010 in.) excursion, 10 to 55 Hz.

Size: (1740A) 197 H x 335 W x 597 mm D (7.8" x 13.2" x 23.5") with handle, 492 mm D (19.4") without; (1741A) 616 mm D (24.3") with handle, 552 mm D (21.7") without; (1742A) 570 mm D (22.4") with handle, 502 mm D (19.8") without; (1743A) 613 mm D (24.1") with handle, 549 mm D (21.6") without; (1744A) 635 mm D (25") with handle; 511 mm D (20.1") without.

Accessories furnished: one blue light filter HP P/N 01740-02701, one front panel cover, one 2.3 m (7.5 ft) power cord, one vinyl accessory storage pouch, one Operators Guide and one Service Manual, two Model 10041A 10:1 divider probes $\approx 2\text{ m}$ (6.6 ft) long. The 1741A and 1744A also include one Model 10173A RFI filter and contrast screen, and one Model 10140A viewing hood.

Options and Accessories

001: fixed power cord (U.S. only).

002 (1741A): Triggered A vs B Mode; phase shift $\leq 2^\circ$, dc to 5 MHz; internal triggering on channel B.

003: Auto Camera (1741A)

005 (1740A or 1741A): TV sync

034 (except 1743A, 1744A): built-in DMM (60 Hz)

035 (except 1743A, 1744A): built-in DMM (50 Hz)

091: two 3 m (9.8 ft) 10042A 10:1 probes in lieu of 10041A probes

096: two 1.8 m (6 ft) 10006D 10:1 probes in lieu of 10041A probes.

101 (except 1744A): state display (deletes A vs B mode) single switch interface for use with 1607A Logic State Analyzer.

112: includes 1112A Inverter Power Supply, a portable power source for 1700 series oscilloscopes.

910: extra set of product manuals.

Multimeter kit: HP P/N 01742-69501 (1742A), 01741-69502 (1741A), or 01740-69503 (1740A) adapts standard oscilloscope to an Option 034/035 with built-in LED readout. Kit includes a multimeter, top oscilloscope cover, vinyl storage pouch, and mounting hardware.

Opt 101 Field Instl Kit: converts std 1740 series oscilloscopes (except 1744A) to Opt 101. Order HP P/N 01740-69501 for 1740A, 1742A, 1743A; order HP P/N 01741-69501 for 1741A.

Logic State Analysis Equipment Required for Option 101

1607A: 16-Bit Logic State Analyzer including three data probes and one clock probe. \$3600

Four 10121A: 20 cm (8") cables. Three for X, Y, and Z and one for pattern trigger connections. \$20 ea.

Adapter plate and strap: (HP P/N 5061-1213) for mounting the oscilloscope on top of the 1607A. \$24

Ordering Information

1740A 100 MHz Oscilloscope	\$2850
1741A 100 MHz Storage Oscilloscope	\$5100
1742A 100 MHz Δ Time Oscilloscope	\$3150
1743A 100 MHz Δ Time Oscilloscope	\$3925
1744A 100 MHz Storage Oscilloscope	\$6250

- 200 MHz (1715A) and 275 MHz (1725A) bandwidths
- Two marker delta time measurements
- Optional DMM
- Selectable input impedance

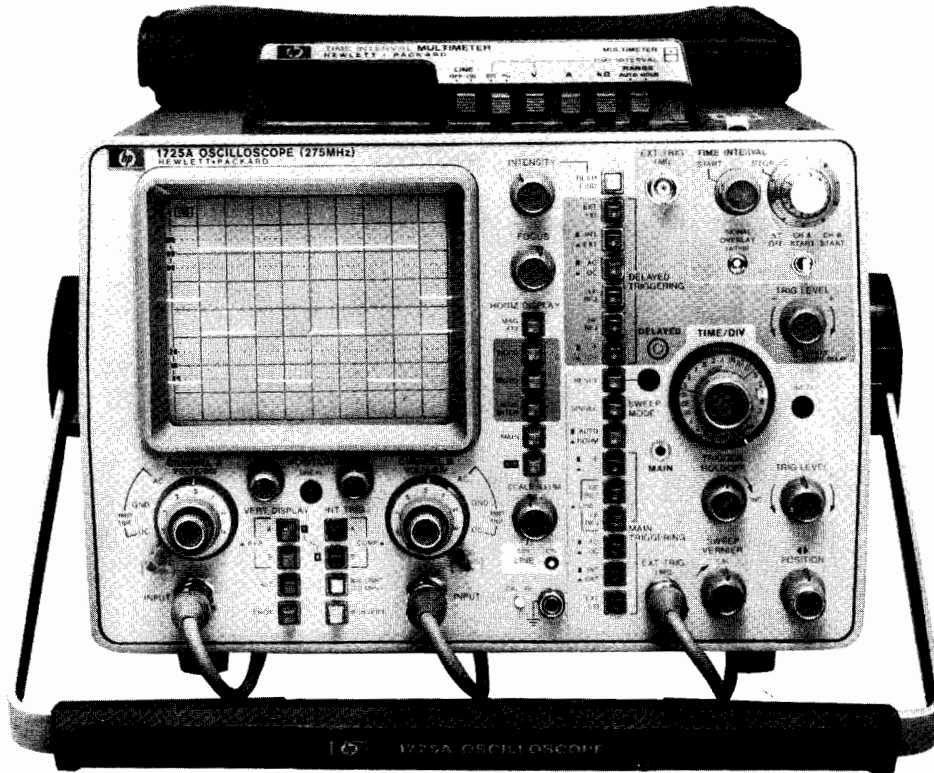

1725A Opt 034

1715A, 1725A Description

Hewlett-Packard's Models 1725A, 275 MHz, and 1715A, 200 MHz oscilloscopes offer delta time measurements with an optional DMM for direct delta time readout and current, voltage, or resistance measurements. The large 8 × 10 cm display provides easy viewing of dual trace signals on which timing measurements can be made conveniently and accurately using the Hewlett-Packard developed delta time technique. For easier percentage measurements, reference lines of 0% and 100% amplitude are 5 divisions apart and markings for 10% and 90% and 20% and 80% are also provided for easier transition time measurements. Vertical deflection factors of 10 mV/div to 5 V/div over the full bandwidth (5 mV/div to 150 MHz in the 1715A) and a selectable 50 ohm or 1 megohm input offer the high performance required for both laboratory and field applications.

Delta Time Measurements

These oscilloscopes offer two methods for making timing measurements; one is the familiar single marker delayed sweep, using the calibrated delay control to accurately measure time relationships; the second is a system of dual intensified markers which significantly improves accuracy while conveniently reducing the time necessary to make a measurement. The latter, better known as the Delta Time measurement method, incorporates a system of two intensified markers which are two delayed sweeps displayed alternately.

The Delta Time measurement technique is to select the Main Intensified mode and position the first marker at t_1 with the Time Interval Start control and position the second marker at t_2 with the Time Interval Stop control. The difference between the two selected points is then read directly on the optional DMM or on the calibrated delay time control, or is available as a rear panel scaled voltage output compatible with most DVM's. Units of seconds, milliseconds, or microseconds are read on the Main Time/Div control.

For increased precision, Delayed Sweep mode is selected where the two intensified portions are displayed alternately. Maximum accuracy is achieved by superimposing the start and stop points using the

Time Interval Stop control. Even without an external voltmeter and using only the Time Interval Stop control, this optical nulling technique reduces the chance of error in time interval measurements.

The Delta Time technique makes timing measurements such as transition times, propagation delay, clock phasing, and other high speed digital timing measurements faster and with more repeatability than with standard delayed sweep oscilloscopes. Time interval measurements can be made between two events on channel A, two events on channel B, or between two events on alternate channels.

Optional Digital Multimeter

Adding an optional multimeter to the 1715A or 1725A improves the accuracy and convenience of delta time measurements as well as improving basic measurement capabilities. A switch on the instrument allows selection of direct delta time measurements or DMM operation. The DMM mode provides the five most common measurements: ac and dc voltage, ac and dc current, and resistance. This versatile DMM includes autopolarity, autozeroing, and autoranging to make direct convenient measurement. Using a Model 10023A Temperature Probe with the DMM, fast, accurate temperature measurements are easy to make. The pencil-like tip accesses small components and the temperature is displayed directly in degrees Celsius on the DMM.

Optional TV Sync

A TV sync option (005) is available for the 1715A and 1725A. This option provides external main and external delayed triggers to the instrument. A sync separator derives these triggers from the composite video which allows the analysis of fields, test signals, timing relationships, lines, or segments of lines. This added TV sync capability in a high frequency oscilloscope offers the ability to view either video signals or the fast transitions and timing relationships of high speed logic in today's video systems. For more information, ask your local HP Field Engineer for the 1715A/1725A TV Sync Data Sheet.



Models 1715A, 1725A, 1722B, 1727A

- 275 MHz bandwidth
- Microprocessor calculated delta time measurements
- Direct LED readout with 20 ps resolution
- Selectable input impedance

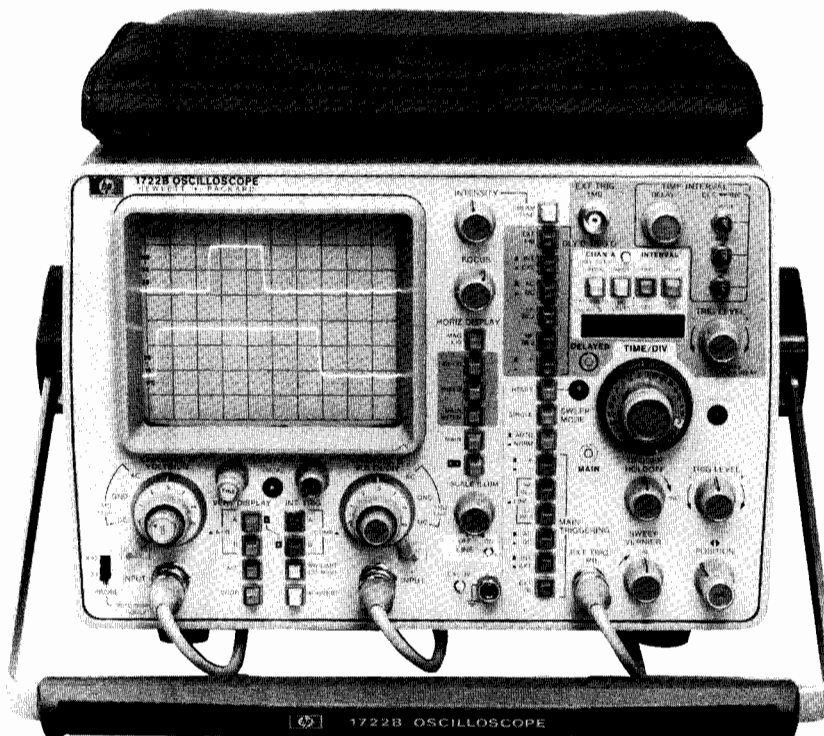

1722B

1722B Description

Model 1722B is a 275 MHz bandwidth, 1 ns/div sweep speed, dual channel oscilloscope with a built-in microprocessor and five function LED display for precise real time measurements. In addition to the conventional volts versus time CRT display, the microprocessor gives you direct readout of delta time, frequency, dc voltage, instantaneous waveform voltage, and percent amplitude. The 1722B's outstanding repeatability and 20 ps resolution make it ideally suited for making clock phasing measurements in large computer timing applications.

Delta Time Measurements

Delta time measurement, developed by Hewlett-Packard, is used in the Time Interval mode for making accurate time interval measurements including transition time, pulse duration (width), period, and propagation delay. Time interval measurements can be made between two events on Channel A, two events on Channel B, or between an event beginning on Channel A and ending on Channel B.

The delta time measurement technique is to select Main Intensified mode and set the first intensified marker to t_1 . The second intensified marker is positioned by using the DEC→INC controls (coarse, medium, or fine) which causes the microprocessor to develop the voltage to position the second marker. While developing the voltage ($t_2 - t_1$) to separate the two markers, the microprocessor drives and updates the 3 1/2 digit LED display. Time interval measurements are automatically scaled for the proper sweep speed and displayed in units of seconds (exponent 0), milliseconds (exponent -3); microseconds (exponent -6); or nanoseconds (exponent -9).

Additional precision is obtained by switching to the Delayed Sweep mode where the two intensified markers are expanded and displayed alternately. Maximum accuracy is quickly obtained by overlapping the two expanded sweeps using the DEC→INC controls. Superimposing the start and stop points of the measured time interval provides a more accurate digital readout by nulling any amplifier or CRT nonlinearities. Separate portions of a sweep can be magnified and examined simultaneously, enabling you to view two events separated in time while maintaining their relative time relationship.

The microprocessor not only keeps track of the distance between the two markers but automatically expands the measurement resolution by a factor of 10 whenever the two markers are within 1 div of each other. The microprocessor also interrogates the function switches to help prevent inaccurate measurements.

1/Time (Frequency) Measurements

The 1722B gives an automatic 3 or 4 digit display of the reciprocal of time, eliminating the need for calculations when setting up clock frequencies and measuring the frequency or repetition rate of a waveform.

DC voltage measurements

The Input (dc volts) mode provides a direct digital display of the average value of a waveform at the input to channel A. The built-in DVM measurement is made using a successive approximation algorithm controlled by the microprocessor which allows you to establish a reference level with respect to any voltage and enables differential dc measurements.

Instantaneous Voltage Measurements

In the Position mode you can measure the voltage at any point on a waveform in channel A without the need to count divisions from a base line and multiply by the attenuator setting. The measurement mode is useful for measuring peak voltages, crossover, and threshold points in logic circuits, or any time you need to know a precise voltage at a particular point on a waveform.

Percentage Measurements

Percentage measurements are made in the Position mode with the channel A vernier out of the Cal position to establish 5 div separation between the 0% and 100% points. By positioning the desired 0% point on a convenient graticule line, zeroing the LED display, and then positioning the waveform to the 100% point, percent amplitude of any point on the waveform with respect to the 100% point is measured by positioning that point at the reference graticule and reading the LED display. Relative amplitude measurements such as pulse overshoot, ringing, preshoot, and percent amplitude modulation on an rf carrier are easily measured using this measurement mode.



- 2000 cm/ μ s Variable Persistence and Stored Writing Speed
- Minimum Blind Time, Auto Intensity Circuit
- 275 MHz bandwidth, 10 mV/div with 1 M Ω or 50 Ω input
- Delta Time and Optional DMM

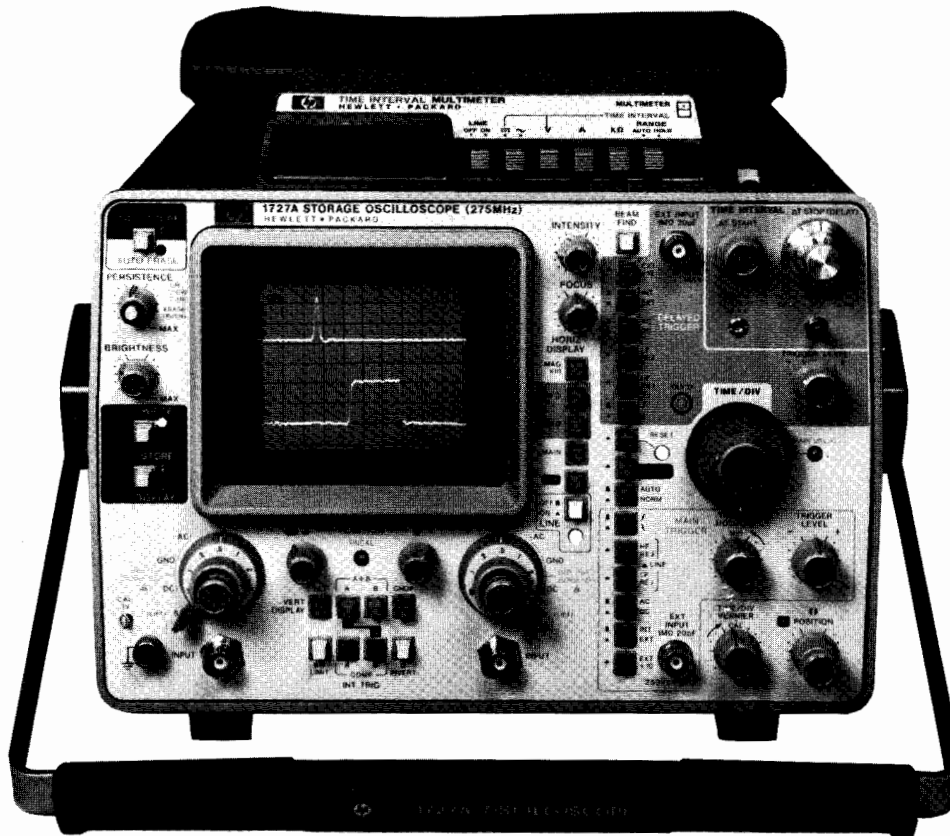

1727A Opt 034

1727A Description

Hewlett-Packard's 275 MHz, Model 1727A Variable Persistence/Storage Oscilloscope offers 2000 cm/ μ s writing speed in both the variable persistence and single shot storage modes. The fast writing speed and large display area make the 1727A ideal for the viewing and analysis of narrow pulses in the physical sciences as well as glitches and noise pulses in digital environments. Signals with rise times as fast as 1.27 ns (4 div) can be captured and displayed in the single-shot mode.

Conveniently grouped variable persistence storage controls, front panel color coding, LED indicators, and automatic operating modes make the 1727A one of the easiest-to-use, high-speed storage oscilloscopes available today. Additional features which provide exceptional versatility and ease-of-use include dual marker delta time measurements; an auto-intensity circuit to greatly simplify the setup of a sharp, nonblooming trace; and selectable input impedance (1 M Ω /50 Ω) for both general purpose probing and high fidelity, high frequency signal capture with the built-in 50 ohm impedance matching.

Expansion Storage

The expansion storage CRT (refer to 1744A for illustration) has a miniature storage mesh, about the size of a postage stamp, and an electronic lens system to present well defined sharp traces at the high writing speed of 2000 cm/ μ s in a variety of operating modes. The fast CRT writing speed is obtained over the full display quality area. Other ease-of-use features include an automatic focus circuit that maintains a crisp display with changes in intensity, and an auto intensity circuit that minimizes blooming and reduces operator concern about CRT damage.

Variable Persistence Is General Purpose

The ability to write at 2000 cm/ μ s in the variable persistence mode makes the 1727A a general purpose instrument. An extremely useful

capability of the variable persistence mode is that the effective writing speed can be increased by integrating repetitive signals. With the 1727A, only two or three repetitions of a signal in a 10 second time period are needed to view any signal compatible with the vertical and horizontal specifications. For example, a 275 MHz sine wave with an amplitude of 8 divisions at a sweep speed of 1 ns/div has a maximum spot velocity of 5028 cm/ μ s and only requires about three repetitions for viewing.

The following table is a convenient quick reference guide for determining the single-shot signals that can be captured by a 1727A.

Amp p-p	Sine Wave MHz	Observed Pulse Tr	Sweep Speed ns/div	Req Writing Speed cm/ μ s
4 div		1.27 ns	1	1952
4 div		1.27 ns	10	1816
3 div	275		1	2000
3 div	275		10	1867
4 div	200		1	1948
4 div	200		10	1811

Delta Time Measurements

In the variable persistence mode, the 1727A can make delta time measurements using the two marker delta time system. This delta time system simplifies time interval measurements while improving both accuracy and resolution. In the delta time mode, Start and Stop markers are alternately displayed on the main intensified sweep. The time interval between these markers can be displayed on the optional DMM or it is available as a scaled voltage output, on the rear panel, that is compatible with most DVMs. Time interval measurements may also be made without a DVM using the helidial for determining the measurement.



1715A, 1722B, 1725A, 1727A Specifications

Vertical Display Modes

Channel A; channel B; A and B displayed alternately on successive sweeps (ALT); A and B displayed by switching between channels at ≈ 1 MHz rate with blanking during switching (CHOP); A plus B (algebraic addition); X-Y (A vs. B).

Vertical Amplifiers (2)

Bandwidth: (3 dB down from 6 div reference signal).

DC-coupled: (1722B, 1725A, 1727A) dc to 275 MHz, (1715A) dc to 200 MHz 10 mV/div to 5 V/div (to 150 MHz at 5 mV/div, 1715A), in both 50 Ω and high Z input modes.

AC-coupled: lower limit ≈ 10 Hz.

Bandwidth limit: limits upper bandwidth to ≈ 20 MHz.

Rise time: (1722B, 1725A, 1727A) < 1.3 ns; (1715A) < 1.75 ns 10 mV/div to 5 V/div, < 2.3 ns at 5 mV/div.

Deflection factor: Ranges, 10 mV/div to 5 V/div (9 calibrated positions) in 1, 2, 5 sequence, $\pm 2\%$ attenuator accuracy; 5 mV/div to 5 V/div (10 calibrated positions) in 1715A; Vernier, extends max deflection factor to ≥ 12.5 V/div.

Polarity: channel B may be inverted.

Input coupling: selectable, AC or DC, 50 Ω (dc) or ground.

Input RC (selectable): AC and DC, 1 M Ω $\pm 2\%$ shunted by ≈ 11 pF; 50 Ω , 50 Ω $\pm 2\%$; SWR (1722B, 1725A, 1727A) ≤ 1.3 on 10, 20, and 50 mV ranges, < 1.15 on all other ranges; SWR (1715A) ≤ 1.3 on 5, 10, 20, and 50 mV ranges and < 1.15 on all other ranges.

Max input: 1 M Ω , ± 250 V (dc + pk ac) at ≤ 1 kHz; 50 Ω , 5 V rms.

A+B operation: Amplifier, bandwidth and deflection factors are unchanged; channel B may be inverted for A-B operation; Differential (A-B) Common Mode, CMR is ≥ 40 dB from dc to 5 MHz decreasing to 26 dB at 50 MHz. Common mode signal amplitude equivalent to 12 div with one vernier adjusted for optimum rejection.

Channel A Input-dc Volts (1722B)

X1 range: 95 mV to 47 V fs vertical deflection (10 mV/div to 5 V/div).

X10 range: 0.95 V to 470 V full scale vertical deflection (100 mV/div to 50 V/div with X10 probe).

Accuracy: $\pm 0.5\%$ reading $\pm 0.5\%$ full scale (f.s. = 10 cm), $+20^\circ\text{C}$ to $+30^\circ\text{C}$; Stability, temperature coefficient, $< \pm 0.02\%/^\circ\text{C}$.

Input impedance: X1 range, 1 M Ω shunted by ≈ 11 pF; X10 range (with X10 probe) 10 M Ω shunted by ≈ 10 pF.

Sample rate: $\approx 2/s$, response time ≤ 1 s.

Channel A Position - Volts (1722B)

(Channel A vernier in CAL detent.)

Measurement: dc substitution method using channel A position control to determine voltage of any point on displayed waveform using any graticule line as reference.

Bandwidth: dc to 275 MHz (≤ 3 dB down from 6 div ref signal).

Dynamic range: ± 6 cm from ground referenced to center screen.

Accuracy: $\pm 1\%$ reading $\pm 0.5\%$ of full scale (10X the volts/div range) measured at dc.

Channel A Position - % (1722B)

(Channel A vernier out of CAL detent.)

Measurement: dc substitution method using channel A position control to determine percent of any waveform point with respect to user defined 0 and 100% points. Accuracy $\pm 1\%$.

Range: 0 to $\pm 140\%$ (set with vernier so that 100% equals 5 div).

Vertical Output (Rear Panel)

Amplitude: one div of vertical deflection produces ≈ 100 mV output, dc to 50 MHz in 1722B, 1725A, 1727A, dc to 25 MHz in 1715A.

Cascaded deflection factor: 1 mV/div with both vert channels set to 10 mV/div. Bandwidth, dc to 5 MHz (with bandwidth limit). Source resistance, $\approx 100\Omega$; selection, trig source set to A selects channel A output, to B selects channel B output.

Horizontal Display Modes

Main, main intensified (1715A, 1722B, 1725A), delayed, mixed, X-Y, and mag X10. The 1727A main intensified mode is automatically selected whenever the delayed time base is turned on.

Main Time Base

Sweep

Ranges: 10 ns/div to 0.5 s/div (24 ranges) 1, 2, 5 sequence.

Accuracy

Main Sweep Time/Div	Accuracy (0°C to +55°C)	
	X1	X10
10 ns to 50 ns	$\pm 3\%$	$\pm 5\%$
100 ns to 20 ms	$\pm 2\%$	$\pm 3\%$
50 ms to 0.5s	$\pm 3\%$	$\pm 3\%$

Vernier: extends slowest sweep to at least 1.25 s/div.

Magnifier: extends fastest sweep to 1 ns/div.

Sweep Mode

Normal: sweep is triggered by internal or external signal.

Automatic: baseline displayed in absence of input signal. Triggering is same as normal above ≈ 40 Hz.

Single: in Normal, sweep occurs once with same triggering as Normal, reset arms sweep and lights indicators; in Auto, sweep occurs once each time Reset is pressed. (1727A) Erase pushbutton arms sweep, lights indicator, and performs the Reset function immediately following the erase cycle.

Triggering

Source: channel A, B, Comp, or line frequency.

Internal: dc to 100 MHz on signals causing ≥ 0.5 div vertical deflection, increasing to 1 div of vert deflection at 300 MHz (200 MHz, 1715A) in all display modes. Line freq. triggering selectable.

External: dc to 100 MHz on signals ≥ 50 mV p-p increasing to 100 mV p-p at 300 MHz (200 MHz, 1715A). Max input, ± 250 V (dc + peak ac) at ≤ 1 kHz. Input RC ≈ 1 M Ω shunted by ≈ 15 pF.

Trigger Level and Slope

Internal: at any point on the vertical waveform displayed.

External: $+1.0$ V to -1.0 V ($+10$ V to -10 V in $\div 10$ mode).

Coupling: AC, DC, LF REJ, or HF REJ.

Trigger holdoff: variable, to > 1 sweep from 10 ns/div to 50 ms/div.

Main Intensified

Delayed sweep: intensifies that part of main time base to be expanded to full screen in delayed mode.

Delta time mode: intensifies two parts of main time base that are expanded in delayed mode.

Delayed Time Base

Sweep

Ranges, 10 ns/div to 20 ms/div (20 ranges) in 1, 2, 5 sequence.

Accuracy, same as main time base.

Triggering

Internal: same as main time base, no Line Frequency triggering.

Starts after delay: sweep starts at end of delay period.

Trigger: with delayed trigger level control out of detent (starts after delay) delayed sweep is triggerable at end of delay period.

Delay time range: 0.5 to 10X Main Time/Div settings of 20 ns to 0.5 s (min delay 50 ns).

External triggering, external input RC, max external input, trigger level and slope, and coupling are same as main time base.

Differential time accuracy (1715A, 1725A, 1727A)

Main Time Base Setting	Accuracy (+15°C to +35°C)
50 ns/div to 20 ms/div	$\pm(0.5\%$ of reading $+0.1\%$ of full scale)
20 ns/div	$\pm(1\%$ of reading $+0.2\%$ of full scale)
50 ms/div to 0.5 s/div	$\pm 3\%$

Delay jitter: $< 0.005\%$ of max delay in each step.

Stability (0°C to +55°C): short term 0.005%. Temperature, $\pm 0.03\%/^\circ\text{C}$ deviation from calibration temperature range.



Time Interval (Δ Time Mode—1715A, 1725A, 1727A)

Function: measures time interval between two events on channel A (A display), on channel B (B display), or starting from an event on either A or B and ending with an event on either A or B (alt display).

Time interval output voltage: from 50 V to 100 mV full scale.

Accuracy: Time Interval Accuracy plus DVM accuracy.

Main Time Base Setting	Accuracy (+20°C to +30°C)
100 ns/div to 20 ms/div	$\pm 0.5\%$ of reading $\pm 0.05\%$ of fs
50 ns/div*	$\pm 0.5\%$ of reading $\pm 0.1\%$ of fs
20 ns/div*	$\pm 0.5\%$ of reading $\pm 0.2\%$ of fs
50 ms/div to 0.5 s/div	$\pm 3\%$

Time Interval Measurements (1722B)

Time interval delay: continuously variable from 10 ns to 5 s.

Delay jitter: refer to Time Interval Measurements, Stability.

Time Interval Measurement (Time)

Function: measures time interval between two events on channel A (A display), on channel B (B display), or between two events starting from an event on A and one ending on channel B (alt display).

Time Interval Accuracy

Main Time Base Setting	Accuracy (+20°C to +30°C)
100 ns/div to 20 ms/div	$\pm 0.5\%$ of measurement $\pm 0.02\%$ of full scale (for measurements < 1 cm). For measurements > 1 cm, $\pm 0.5\%$ of measurement $\pm 0.05\%$ of full scale.
50 ns/div*	$\pm 0.5\%$ of measurement $\pm 0.06\%$ of full scale.
20 ns/div*	$\pm 0.5\%$ of measurement $\pm 0.15\%$ of full scale.
50 ms/div to 0.5 s/div.	$\pm 3\%$

*Starting after 60 ns of sweep.

Resolution: intervals < 1 cm, > 0.01% of full scale; intervals > 1 cm, 0.1% of full scale; max display resolution, 20 ps.

Stability (0 to +55°C): short term, < 0.01%. Temperature, $\pm 0.03\%/^{\circ}\text{C}$ deviation from calibration temperature range.

Reciprocal of Time Interval Measurement (1/time)

Accuracy, resolution, stability: see time interval measurements.

Mixed Time Base

Dual time base in which the main time base drives the first portion of sweep and the delayed time base completes the sweep.

X-Y Operation

Bandwidth:

Y-axis (channel A), same as channel A;

X-axis (channel B), dc to > 1 MHz.

Deflection factor: 10 mV/div to 5 V/div, 9 cal positions (5 mV/div to 5 V/div, 10 cal positions, 1715A) in 1, 2, 5 sequence.

Phase difference: < 3°, dc to 1 MHz (3 MHz, 1722B).

Cathode-ray Tube and Controls (1715A, 1722B, 1725A)

Type: post accelerator, ≈ 20.5 kV, aluminized P31 phosphor.

Graticule: 8 x 10 div internal graticule, 0.2 subdiv markings on major horiz and vert axes, 1 div = 1 cm. Internal floodgun illum.

Beam finder: returns trace to CRT screen.

Intensity modulation (Z-axis): +8 V, ≥ 50 ns width pulse blanks trace of any intensity, usable to 20 MHz for normal intensities. Input R, 1 k Ω $\pm 10\%$. Max input, ± 10 V (dc + peak ac).

Auto-focus: maintains beam focus with variations of intensity.

Intensity limit: limits beam current to simplify operation. Circuit response time ensures full writing speed.

Cathode-ray Tube and Controls (1727A)

Type: post accelerator, ≈ 9.5 kV, aluminized P31 phosphor.

Graticule: 8 x 10 div internal graticule, 0.2 subdivision markings on major horiz and vert axes, 1 div = 0.72 cm.

Beam finder: returns trace to CRT screen.

Intensity modulation (Z-axis): +4V, ≥ 50 ns width pulse blanks trace of any intensity, usable to 20 MHz for normal intensities. Input R, 1 k Ω $\pm 10\%$. Max input, ± 20 V (dc + peak ac).

Operating modes: write, store, display, auto-store, and auto-erase.

Writing speed, variable persistence and storage: ≥ 2000 cm/ μ s (2775 div/ μ s) over center 6 x 8 div (with viewing hood).

Storage time (at 22°C): display mode, at least 10s; store mode, at least 30s; wait time, at least 60s.

Persistence: variable, ≥ 100 ms.

Erase time: ≈ 300 ms.

Intensity limit: limits beam current to simplify operation. Circuit response time ensures full writing speed.

Auto-focus: maintains beam focus with variations of intensity.

General

Rear panel controls: astigmatism and trace align (both X and Y).

Rear panel outputs: main and delayed gates, -0.7 V to +1.3 V capable of supplying ≈ 3 mA; and vertical output.

Callibrator: type, 1 kHz $\pm 15\%$ ($\pm 10\%$, 1722B) square wave; 3 V p-p $\pm 1\%$, < 0.1 μ s transition time.

Power: 100, 120, 220, and 240 Vac, -10% + 5%; 48 to 440 Hz; 110 VA max.

Weight

1715A, 1725A: net, 12.9 kg (28.5 lb); shipping, 17.9 kg (39.5 lb).

1722B: net 13.6 kg (30 lb); shipping, 19.5 kg (43 lb).

1727A: net, 15.9 kg (35 lb); shipping, 20 kg (44 lb).

Operating environment: temp, 0°C to +55°C; humidity, to 95% rel humidity at +40°C; altitude, to 4600 m (15 000 ft); vibration, in three planes for 15 min. each with 0.254 mm excursion, 10 to 55 Hz.

Size: (1715A, 1725A, 1722B) 197 H x 335 W x 570 mm D (7.75" x 13.8" x 22.4") with handle; (1715A, 1725A) 502 mm D (18.88" without handle; (1722B) 510 mm (20.06") without handle; (1727A) 197 H x 335 W x 652 mm D (7.75" x 13.8" x 25.69") with handle; 595 mm (23.38") without handle.

Accessories furnished: one blue light filter; one panel cover; two 10017A 10:1 divider probes with 1722B, 1725A, 1727A; two 10018A 10:1 divider probes with 1715A; one 2.3 m (7.5 ft) power cord; one vinyl storage pouch; one Operating and Service Manual. The 1727A includes one Model 10173A RFI filter and contrast screen, and one Model 10140A viewing hood.

Options and Accessories

	Price
001: U.S. fixed line cord	add \$15
003: probe power supply with two rear panel jacks for use with HP 1120A or 1124A active probes.	add \$50
034 (except 1722B): built-in DMM (60 Hz)	add \$325
035 (except 1722B): built-in DMM (50 Hz)	add \$325
091 (except 1715A): two 2 m (6.6 ft) 10018A, 10:1 probes substituted for two 10017A miniature probes	N/C
091 (1715A): two 1 m (3.3 ft) 10017A, 10:1 probes substituted for two 10018A miniature probes	N/C
092: two 1.8 m (6 ft) 10016B, 10:1 probes substituted for two miniature probes	N/C
101 (except 1727A): state display-single switch interface for operation with 1607A Logic State Analyzer	add \$150
112: includes 1112A Inverter Power Supply.	add \$1350
910 (except 1727A): additional set of manuals	add \$20
910 (1727A): additional set of manuals	add \$20
Time interval multimeter kit: (HP P/N 01715-69501 for 1715A or 1725A, HPP/N 01727-69501 for 1727A) adapts a standard Model 1715A, 1725A, or 1727A to an Opt 034/035, built-in, LED readout, delta time oscilloscope. Included are a multimeter, a top oscilloscope cover, a vinyl storage pouch, and mounting hardware.	\$375

Logic State Analysis Equip Required for Opt 101

1607A: 16-bit Logic State Analyzer	\$3600
10121A: 20 cm (8") cable for trigger connection	\$20 ea
11170A: 3, 60 cm (24") cables for X, Y, Z connection	\$17 ea
5061-1213: Adapter plate and strap for mounting the oscilloscope on top of the 1607A	\$36

Ordering Information

1715A 200 MHz Oscilloscope	\$3900
1722B 275 MHz Oscilloscope with Microprocessor	\$5500
1725A 275 MHz Oscilloscope	\$4300
1727A 275 MHz Storage Oscilloscope	\$7200

OSCILLOSCOPES

180 Mainframes

Models 180C/D, 181A/AR, & 182C

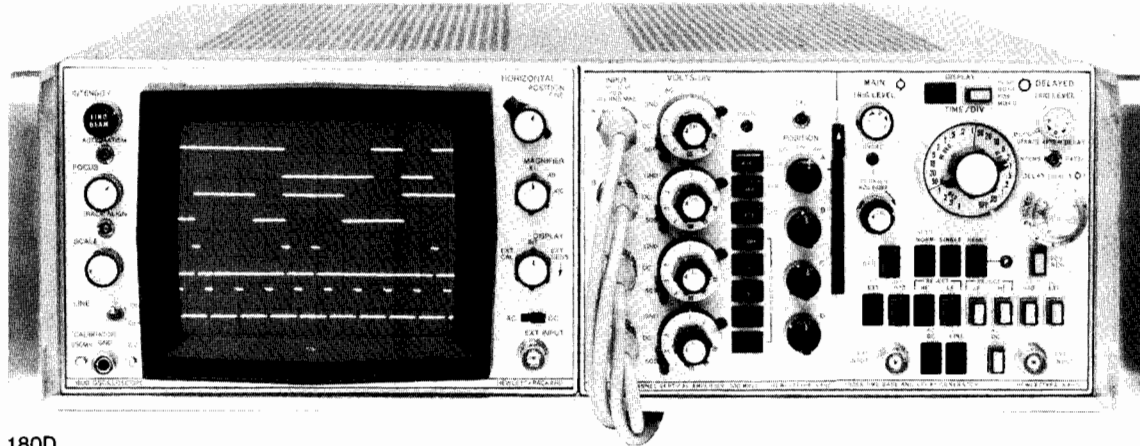

180D

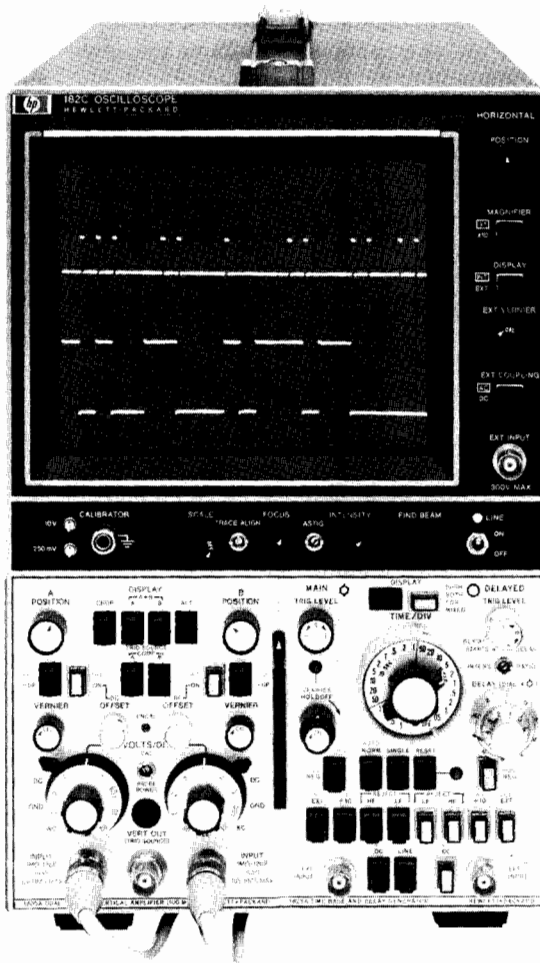

182C

180C/D, 181A/AR, 182C Specifications

Cathode-ray Tube and Controls

Type: post accelerator, 15 kV (180), 8.5 kV (181), 21 kV (182); aluminized P31 phosphor.

Graticule: 8 x 10 div internal graticule, 0.2 div subdivisions on major axes; (180) 1 div = 1 cm, (181) 1 div. = 0.95 cm, (182) 1 div = 1.29 cm.

Beam finder: returns trace to CRT screen.

Intensity modulation (external input): input, $\approx +2$ V, ≥ 50 ns pulse width blanks trace of normal intensity; input $R \approx 50$ k Ω ; Max input, ± 20 V (dc + peak ac) at ≤ 1 kHz.

Persistence, Storage, 181A/AR

Persistence: normal, ≈ 40 μ s; variable, <0.2 to >1 min.

Writing speed: write, >20 cm/ms; max write, >5 cm/ μ s.

Brightness: >342.6 cd/m² (100 fl).

Storage time: from Write to Store, reduced intensity for >1 hr; to View, normal intensity for >1 min. From max Write to Store, reduced intensity for >5 min.; to View, normal intensity for >15 s, pushbutton erasure takes ≈ 300 ms.

Horizontal Amplifier

External Input

Bandwidth: dc-coupled, dc to 5 MHz; ac-coupled, 5 Hz to 5 MHz.

Deflection factor: 1 V/div, X1; 0.2 V/div, X5 (180, 181); 0.1 V/div, X10; accuracy, $\pm 5\%$; dynamic range ± 20 V.

Max input: 600 V dc (ac-coupled input); (182C) ± 300 V (dc + peak ac) at ≤ 1 kHz.

Input RC: ≈ 1 M Ω shunted by ≈ 30 pF.

Sweep magnifier: X10, X5 (180, 181); overall accuracy, $\pm 5\%$.

Calibrator: ≈ 1 kHz square wave, <3 μ s rise time; 250 mV p-p and 10 V p-p into 1 M Ω , $\pm 1\%$.

Outputs

Four rear panel emitter follower outputs for main and delayed gates, main and delayed sweeps. Max current available, ± 3 mA. Will drive impedances ≥ 1000 ohms without distortion.

General

Operating environment: temperature, 0 to 55°C (+32°F to +130°F); humidity, to 95% relative humidity at 40°C (104°F); altitude, to 4600 m (15000 ft); vibration, vibrated in three planes for 15 min. each with 0.254 mm (0.010 in.) excursion, 10 to 55 Hz.

Size

180C, 181A (cabinet): 289 H x 200 W x 540 mm D behind panel (11.4" x 7.9" x 21.3").

180D, 181AR (rack): 133 H x 425 W x 543 mm D overall (5.2" x 16.7" x 21.4") 493 mm (19.4") D behind rack mount tabs.

182C (cabinet): 338.1 H x 201.6 W x 498.5 mm D overall (13.3" x 7.9" x 19.6").

Weight (without plug-ins)

180C (cabinet): net, 10.4 kg (23 lb); shipping, 15.4 kg (34 lb).

180D (rack): net, 11.8 kg (26 lb); shipping, 17.2 kg (38 lb).

182C (cabinet): net, 12.2 kg (27 lb); shipping, 15.4 kg (34 lb).

181A (cabinet): net, 10.9 kg (24 lb); shipping, 15.4 kg (34 lb).

181AR (rack): net, 11.8 kg (26 lb); shipping, 17.2 kg (38 lb).

Power: 115 or 230 V, $\pm 10\%$, 48 to 440 Hz; max mainframe power, 200 VA, (181) 225 VA.

Accessories Supplied

180, 181: 2.3 m (7.5 ft) power cord, blue plastic light filter (HP P/N 5060-0548), Model 10178A mesh contrast filter (181), one Operating and Service Manual. A rack mount kit (HP P/N 5060-0552) and 2 clip-on probe holders (HP P/N 5040-0464) are supplied with the 180D, 181AR rack models.

182C: 2.3 m (7.5 ft) power cord, blue plastic light filter (HP P/N 5060-0547), one Operating and Service Manual.

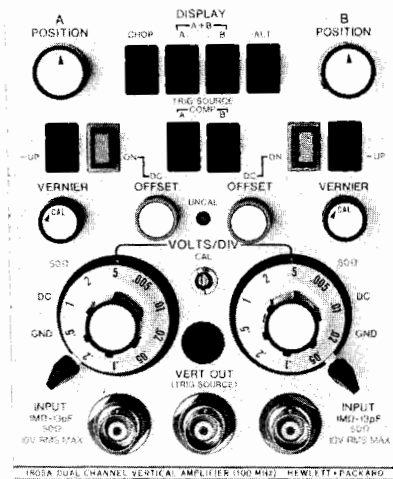

1805A, 100 MHz 2 channel

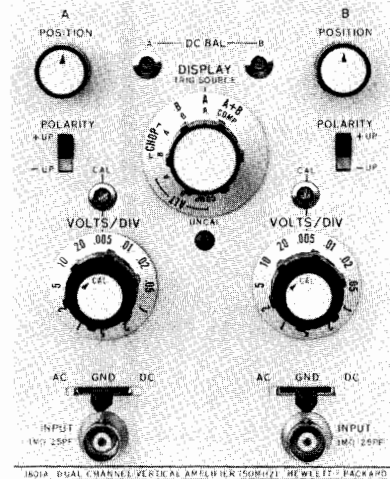

1801A, 50 MHz 2 channel

1805A, 1801A Specifications

Modes of Operation

Channel A; Channel B; A and B displayed alternately on successive sweeps (ALT); A and B displayed by switching between channels at approx 400 kHz rate (CHOP) with blanking during switching; A plus B (algebraic addition).

Each Channel (2)

Bandwidth: (measured with or without 10014A probe (1805A), 10004D probe (1801A), 3 dB down from 8 div ref signal from a terminated 50Ω source.)

DC-coupled: (1805A) dc to 100 MHz, (1801A) dc to 50 MHz.

AC-coupled: (1805A) ≈ 10 Hz to 100 MHz, (1801A) ≈ 8 Hz to 50 MHz.

Rise time: (1805A) < 3.5 ns (measured with or without 10014A probes, 10% to 90% points of 6 div input step from a terminated 50Ω source); (1801A) < 7 ns (measured with or without 10004D probe, 10% to 90% points of 8 div input step from a terminated 50Ω source).

Deflection Factor

Ranges: (1805A) 5 mV/div to 5 V/div (10 cal positions) in 1, 2, 5 sequence; ± 2% attenuator accuracy. (1801A) 5 mV/div to 20 V/div (12 positions) in 1, 2, 5 sequence; ± 3% attenuator accuracy.

Vernier: extends max deflection factor ≥ 12.5 V/div (1805A), ≥ 50 V/div (1801A).

Polarity: + up or - up selectable.

Input coupling: (1805A) AC, DC, 50Ω (dc), or ground; (1801A) AC, DC, or ground.

Input RC: (1805A) AC and DC, 1 MΩ ± 1% shunted by ≈ 13 pF; 50Ω, 50Ω ± 2%; SWR < 1.2 at 100 MHz on all ranges. (1801A) ≈ 1 MΩ shunted by ≈ 25 pF.

Max input: (1805A) AC and DC, ± 300 V (dc + peak ac) at ≤ 1 kHz; ± 150 V (dc + peak ac) on 5 mV/div range at ≤ 1 kHz; 50Ω, 10 V rms, DC-coupled. (1801A) DC-coupled ± 350 V (dc + peak ac) at ≤ 10 kHz; ± 150 V (dc + peak ac) on 5 mV/div range at ≤ 1 kHz; AC-coupled, ± 600 V dc.

Dynamic range (1805A): 6 div at 100 MHz to 16 div at ≤ 15 MHz.

Positioning range (1805A): 16 div.

A + B operation: amplifier bandwidth and deflection factors unchanged; either channel may be inverted for ± A ± B operation. Differential input (A-B) common mode, (1805A) CMR ≥ 40 dB dc to 1 MHz for common mode signals ≤ 16 div, ≥ 20 dB at 50 MHz for signals ≤ 6 div; (1801A) CMR ≥ 40 dB at 5 mV/div and ≥ 20 dB on other ranges, dc to 1 MHz, for common mode signals ≤ 24 div.

Offset (1805A): ± 200 div of offset.

Triggering (1805A)

Source: selectable from channel A, channel B, or a composite (Comp) signal from A and B in any display mode. Composite is A and B signals switched for Alt and Chop modes and added for A and B mode. Vernier and position controls do not affect A, B, or composite trigger signals. A and B signals are independent of polarity selection.

Frequency

Time Base Plug-in	Trigger Frequency*	Required Vertical Deflection
1825A	dc-50 MHz	½ div
	dc-100 MHz	1 div
1821A	dc-50 MHz	1 div

*all display modes except Chop, dc to 100 kHz in Chop.

Triggering (1801A)

Source: for channel A or B, on signal displayed; Chop selectable from A or B; Alt selectable from A, B, or Comp (A and B switched).

Frequency: dc to > 50 MHz on signals causing ≥ 0.5 div vert deflection in all display modes except Chop which is dc to 100 kHz.

Vertical Signal Output (1805A)

Bandwidth: > 50 MHz into 50Ω.

Amplitude: > 50 mV for each div of display into 50Ω with useable amplitudes up to 500 mV p-p.

Source impedance: ≈ 50 ohms.

General

Operating environment: same as 180 C/D mainframes.

Weight

1805A: net 2.3 kg (5 lb); shipping, 3.6 kg (8 lb).

1801A: net 1.8 kg (4 lb); shipping, 3.6 kg (8 lb).

Accessories supplied: (1805A) two 10014A 10:1 divider probes ≈ 1.1 m (3.5 ft), one Operating and Service Manual. (1801A) two 10004D, 10:1 divider probes, ≈ 1.1 m (3.5 ft), one Operating and Service Manual.

Recommended probes: (1805A) full performance maintained by 10014A, 10016B passive probes, 10017A, 10018A miniature passive probes, 10026A, 10027A miniature 50Ω probes, 10020A resistive divider probe kit, and the 1120A active probe; (1801A) full performance maintained by 10004D, 10005D, and 10006D passive probes and 10041A, 10042A miniature passive probes.

OSCILLOSCOPES

180 Vertical & Time Base Plug-Ins

Models 1809A & 1821A

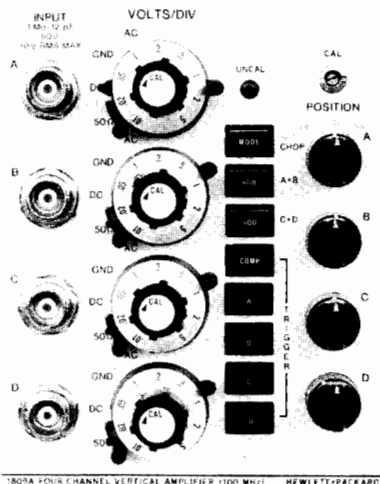

1809A, 100 MHz 4 channel

1809A Specifications

Modes of Operation

Channels A, B, C, or D or any combination displayed alternately on successive sweeps (ALT) or chopped (CHOP) with blanking during switching; either A and B or C and D may be algebraically added ($\pm A \pm B$) or ($\pm C \pm D$). Approx chop rate for two channels displayed is 1 MHz, 3 channels is 667 kHz, 4 channels is 500 kHz.

Each Channel (4)

Bandwidth: (measured with or without 10014A probe, 3 dB down from a terminated 50Ω source.)

DC-coupled: dc to 100 MHz.

AC-coupled: ≈ 10 Hz to 100 MHz.

Rise time: < 3.5 ns. Measured with or without 10014A probe, 10% to 90% of 6 div input step from a terminated 50Ω source.

Deflection Factor

Ranges: from 0.01 V/div to 5 V/div (9 cal positions) in 1, 2, 5 sequence. Attenuator accuracy, $\pm 2\%$.

Vernier: extends max deflection factor to ≥ 12.5 V/div.

Input coupling: ac, dc, 50Ω (dc), or ground.

Input RC (selectable): AC or DC, 1 MΩ, $\pm 1\%$ shunted by ≈ 12 pF; 50Ω, 50Ω $\pm 2\%$. SWR, 1.3 at 100 MHz on all ranges.

Max input: AC and DC, ± 300 V (dc + peak ac) at ≤ 1 kHz, ± 150 V (dc + peak ac) on 10 mV/div range at ≤ 1 kHz; 50Ω, 10 V rms.

Polarity: any channel may be inverted ($\pm A$, $\pm B$, $\pm C$, $\pm D$).

Algebraic Addition (A + B), (C + D)

Amplifier: bandwidth and deflection factors are unchanged, any channel may be inverted for ($\pm A \pm B$) or ($\pm C \pm D$) operation.

Differential input (A - B) or (C - D) common mode: CMR is ≥ 20 dB from dc to 80 MHz on all ranges.

Triggering

Source: selectable from channel A, B, C, D, or composite (on displayed signals) in all display modes.

Frequency

Time Base Plug-in	Trigger Frequency*	Required Vertical Deflection
1825A	dc-50 MHz dc-100 MHz	$\frac{1}{2}$ div 1 div
1821A	dc-50 MHz	1 div

*All display modes except Chop, dc to 100 kHz in Chop.

General

Operating environment: same as 180C/D mainframes.

Weight: net, 3.2 kg (7 lb); shipping, 4.5 kg (10 lb).

Accessories supplied: one Operating and Service Manual.

Recommended Probes

Models 10014A, 10016B, 10017A, and 10018A for 1 MΩ mode. Models 10020A, 10026A, and 10027A for 50Ω input mode.



1821A, 50 MHz triggering

1821A Specifications

Main Time Base

Sweep

Ranges: from 0.1 μ s/div to 1 s/div (22 positions) in 1, 2, 5 sequence; $\pm 3\%$ accuracy with vernier in CAL position.

Vernier: extends slowest sweep to at least 2.5 s/div.

Magnifier: (mainframe) expands fastest sweep to 10 ns/div.

Sweep Mode

Normal: triggered by an int, ext, or power line signal.

Automatic: baseline displayed in absence of input signal. Above ≈ 40 Hz triggering same as normal.

Single: sweep occurs once with same triggering as normal.

Trace Intensification

In Main sweep mode, intensifies that part of Main time base to be expanded to full screen on Delayed time base.

Delayed Time Base

Sweeps after a time delay set by Main and Delay controls.

Sweep

Ranges: from 0.1 μ s/div to 50 ms/div (18 positions) in 1, 2, 5 sequence; $\pm 3\%$ accuracy with Vernier in CAL position.

Vernier: continuously variable between all ranges; extends slowest sweep to at least 125 ms/div.

Triggering

(Main and Delayed time base)

Internal: refer to vertical plug-in specifications.

External: dc to 50 MHz on signals 0.5 V p-p or more, increasing to 100 MHz on signals 1 V p-p or more.

Line: power line frequency signal (main only).

Level and slope: internal, at any point on the vertical waveform displayed; external, continuously variable from +3 V to -3 V on either slope of the sync signal, from +30 V to -30 V in $\div 10$.

Automatic (delayed only): triggered at end of set time delay.

Coupling: AC, DC, ACF (ac-fast), or ACS (ac-slow).

Delay (before start of Delayed sweep)

Time: continuously variable from 0.1 μ s to 10 s.

Accuracy: $\pm 1\%$ of differential delay ± 2 minor divisions of delay dial. Time jitter is 0.005% of max delay of each step.

Trigger output: (at end of Delay time) ≈ 1.5 V with > 50 ns rise time from 1000Ω source resistance.

Mixed Time Base

Dual time base in which Main time base drives first portion of sweep and delayed time base completes sweep at up to 1000 times faster.

General

Operating environment: same as 180 C/D mainframes

Weight: net, 1.8 kg (4 lb); shipping, 3.6 kg (8 lb)

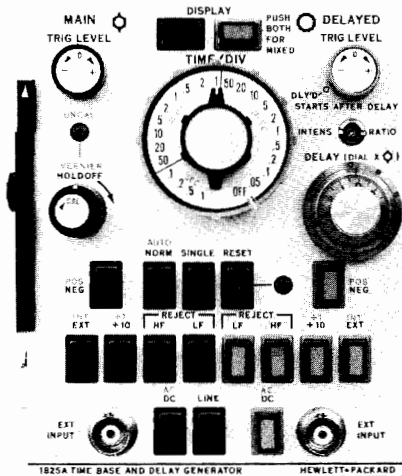

1825A, 100 MHz triggering

1825A Description

Model 1825A time base and delay generator provides sweep speeds ranging from 0.05 $\mu\text{s}/\text{div}$ to 1 s/div in 23 positions. Delay times are continuously variable from 50 ns to 10 s and are accurate to 0.75% with extremely low jitter of 1 part in 50 000. Also, a calibrated mixed sweep mode is provided. A mainframe X10 magnifier increases sweep-speed capability to 5 ns/div with 5% accuracy.

One knob control makes triggering easy in main, delayed, and mixed modes. Stable, accurate time displays are provided in main, delayed, and mixed modes with the highly sensitive 50 mV external trigger capability at 50 MHz which increases to only 150 mV at 150 MHz. Trigger synchronization is maintained when switching between main, delayed, and mixed modes, further simplifying use.

Front panel controls are logically arranged for quick familiarization and easy use. Pushbuttons eliminate front panel clutter and reduce the possibility of errors. Easy-to-operate pushbuttons establish main, delayed, and mixed modes of operation.

Trigger level controls on main and delayed sweeps allow selection of the triggering point on the desired portion of the signal for almost every measurement application. Also, the $\times 10$ function provides a wide dynamic range of triggering in both external and internal modes of operation.

External trigger sensitivity of 50 mV on both main and delayed sweeps allows a 10:1 divider probe to be used to reduce circuit loading at trigger pick-off points and reduces the possibility of circuit malfunction caused by the measuring instrument.

1825A Specifications

Main Time Base

Sweep

Ranges: 0.05 $\mu\text{s}/\text{div}$ to 1 s/div (23 positions) in 1, 2, 5 sequence; $\pm 3\%$ accuracy with vernier in CAL position.

Vernier: extends slowest sweep to at least 2.5 s/div.

Magnifier: (on mainframe) expands fastest sweep to 5 ns/div, accuracy $\pm 5\%$ (main or delayed).

Sweep Mode

Normal: sweep is triggered by an internal, external, or power line signal.

Automatic: baseline displayed in absence of trigger signal. Triggering is same as normal except low frequency limit is 40 Hz.

Single: in Normal, sweep occurs once with same triggering as Normal (reset pushbutton arms sweep and lights indicator); in Auto, sweep occurs once each time reset pushbutton is pressed.

Trace Intensification

In Main sweep mode, intensifies that part of main time base to be expanded to full screen in delayed time base mode. Rotating time base switch from OFF position activates intensified mode.

Delayed Time Base

Delayed time base sweeps after a time delay set by Main time base and Delay controls. Delayed time base is triggered on first trigger pulse after set delay or automatically triggers after set delay when delayed level control is in detent position.

Sweep ranges: 0.05 $\mu\text{s}/\text{div}$ to 20 ms/div (18 positions) in 1, 2, 5 sequence; $\pm 3\%$ accuracy.

Triggering

(Main and Delayed time base)

Internal: refer to vertical amplifier plug-in specifications.

External: dc to 50 MHz on signals 50 mV p-p or more increasing to 100 mV p-p at 100 MHz and 150 mV p-p at 150 MHz.

Line: power line frequency signal (Main only).

Level

Internal: at any point on the vertical waveform displayed.

External: continuously variable from +2 V to -2 V on either slope of trigger signal, from +20 V to -20 V in $\times 10$ setting.

Slope: pushbutton selects either positive or negative slope of trigger signal.

Coupling: AC, DC, HF Reject, or LF Reject. AC, attenuates signals below ≈ 20 Hz; LF reject, attenuates signals below ≈ 15 kHz; HF reject, attenuates signals above 15 kHz.

Trigger holdoff: time between sweeps continuously variable, exceeding one full sweep on all ranges (Main only).

Delay (before start of delayed sweep)

Time: continuously variable from 50 ns to 10 s.

Accuracy: $\pm 0.75\%$ of differential delay ± 2 minor divisions of delay dial.

Time jitter: $\pm 0.002\%$ of max delay on each range.

Calibrated Mixed Sweep

Combines Main and Delayed Sweeps into one display. Sweep is started by the Main time base and is completed by the faster Delayed time base.

Ordering Information

	Price
180C Cabinet Style Main Frame	\$2500
Opt 010: deletes rear panel outputs for main and delayed gates and main and delayed sweeps	N/C
Opt 910: additional Operating and Service Manual	add \$15
180D Rack Style Mainframe	\$2700
Opt 010: (see 180C Option 010)	N/C
Opt 910: additional Operating and Service Manual	add \$15
181A Storage Mainframe, Cabinet Style	\$3650
Opt 910: additional Operating and Service Manual	add \$20
181AR Storage Mainframe, Rack Style	\$3850
Opt 910: additional Operating and Service Manual	add \$20
182C Cabinet Style Mainframe	\$2700
Opt 010: (see 180C Option 010)	N/C
Opt 910: additional Operating and Service Manual	add \$20
1805A 100 MHz Dual Channel Vertical Amplifier	\$2300
Opt 910: additional Operating and Service Manual	add \$15
1801A 50 MHz Dual Channel Vertical Amplifier	\$1725
Opt 001: Channel B output and X5 magnifier	add \$155
Opt 090: 1.8 m (6 ft) 10006D probes in lieu of 10004D	N/C
Opt 091: 3 m (10 ft) 10005D probes in lieu of 10004D	N/C
Opt 910: additional Operating and Service Manual	add \$15
1809A 100 MHz 4 Channel Vertical Amplifier	\$3600
Opt 910: additional Operating and Service Manual	add \$20
1821A Time Base and Delay Generator	\$1950
Opt 910: additional Operating and Service Manual	add \$15
1825A Time Base and Delay Generator	\$1950
Opt 910: additional Operating and Service Manual	add \$15

OSCILLOSCOPES

500 kHz General Purpose

Models 1200A/B, 1201B & 1205B

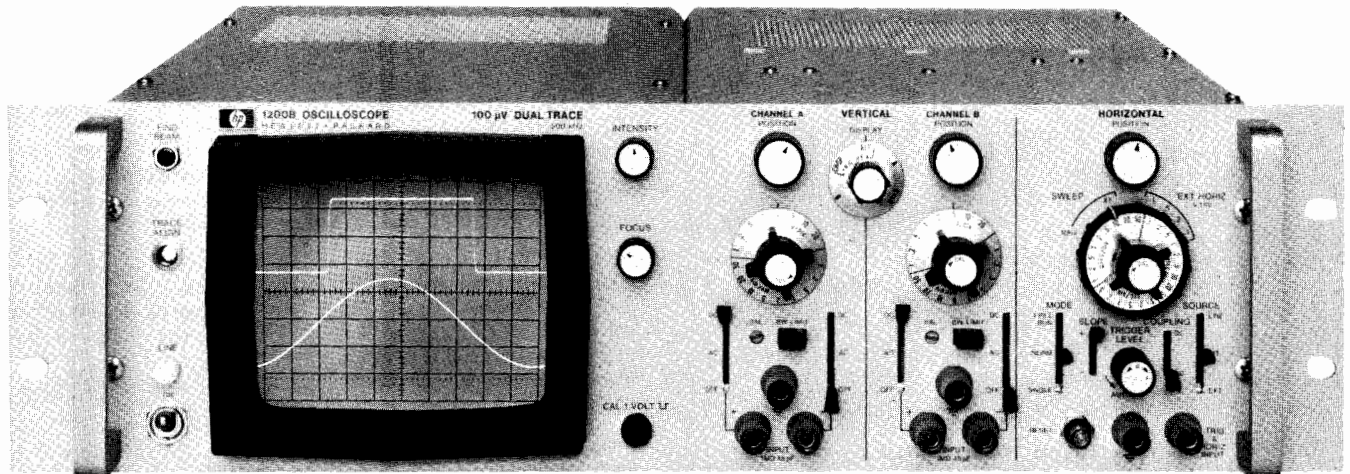

1200B

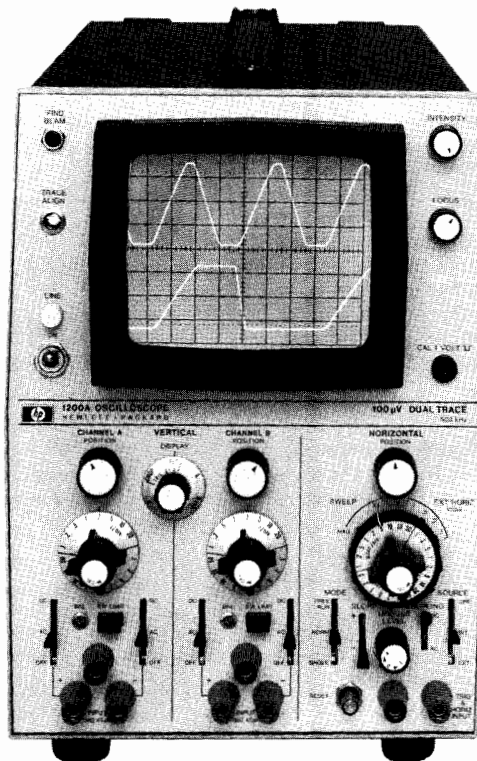

1200A

1200A/B, 1201B, 1205B Specifications

Vertical Amplifiers

Modes of operation: channel A; channel B; channels A and B (either Chop or Alternate triggered by channel A), Chop frequency is ≈ 100 kHz; channel A vs B (A-vertical, B-horizontal).

Bandwidth: dc-coupled, dc to 500 kHz; ac-coupled, 2 Hz to 500 kHz. Bandwidth limit switch (1200 and 1201) selects upper bandwidth to ≈ 50 kHz or 500 kHz.

Rise time: $0.7 \mu\text{s}$ max.

Deflection Factor

Ranges (1200 and 1201): from 0.1 mV/div to 20 V/div (17 positions) in 1, 2, 5 sequence.

Ranges (1205): from 5 mV/div to 20 V/div (12 positions) in 1, 2, 5 sequence.

Attenuator accuracy: $\pm 3\%$ with vernier in Cal.

Vernier: extends max deflection factor to at least 50 V/div .

Noise (1200 and 1201): $< 20 \mu\text{V}$ measured tangentially at full bandwidth.

Input: differential or single-ended on all ranges.

Common Mode

Frequency: dc to 10 kHz.

Rejection ratio

1200 and 1201: 100 dB (100 000 to 1) with dc-coupled input on 0.1 mV/div range, decreasing by $< 20 \text{ dB}$ per decade of deflection factor to at least 40 dB on the 0.2 V/div range; CMR is at least 30 dB on 0.5 V/div to 20 V/div ranges. Max signal is $\pm 10 \text{ V}$ (dc + peak ac) on 0.1 mV/div to 0.2 V/div ranges; $\pm 400 \text{ V}$ (dc + peak ac) on all other ranges.

1205: 50 dB with dc-coupled input on 5 mV/div to 0.2 V/div ranges; CMR $\geq 30 \text{ dB}$ on the 0.5 V/div to 20 V/div ranges. Max signal is $\pm 3 \text{ V}$ (dc + peak ac) on 5 mV/div to 0.2 V/div ranges; $\pm 300 \text{ V}$ (dc + peak ac) on all other ranges.

Input coupling: selectable AC, DC, or OFF for + and - inputs.

Input RC: $\approx 1 \text{ M}\Omega$ shunted by $\approx 45 \text{ pF}$.

Max input: refer to Common Mode Rejection Ratio.

Internal trigger source: on channel A signal for A, Chop, and Alternate displays, on channel B signal for B display.

Isolation: $> 80 \text{ dB}$ between channels at 500 kHz, with shielded input connectors.

Phase shift: A vs B mode, $< 1^\circ$ to 100 kHz with verniers in Cal.

Time Base

Sweep

Ranges: from $1 \mu\text{s/div}$ to 5 s/div (21 positions) in 1, 2, 5 sequence; $\pm 3\%$ accuracy with vernier in Cal.

Vernier: extends slowest sweep to at least 12.5 s/div .

Magnifier: direct reading X10 magnifier expands fastest sweep to 100 ns/div with $\pm 5\%$ accuracy.

Automatic Triggering

Baseline is displayed in absence of an input signal.

Internal: 50 Hz to $> 500 \text{ kHz}$ on most signals causing 0.5 div or more vert. deflection. Triggering on line frequency also selectable.

External: 50 Hz to above 1 MHz on most signals $\geq 0.2 \text{ V p-p}$.

Trigger slope: positive or negative slope on internal, external or line trigger signals.

Amplitude Selection Triggering

Internal: dc to 500 kHz on signals causing $\geq 0.5 \text{ div}$ vert. deflection.

External: dc to 1 MHz on signals $\geq 0.2 \text{ V p-p}$. Input impedance $\approx 1 \text{ M}\Omega$ shunted by $\approx 20 \text{ pF}$.

Trigger level and slope: internal, at any point on vertical waveform displayed; or continuously variable from $+100 \text{ V}$ to -100 V on either slope of the external trigger signal.

Trigger coupling: dc or ac for external, line, or internal triggering. Lower ac cutoff is 2 Hz for external; 5 Hz for internal.

Single sweep: selectable by front panel switch. Reset switch with armed indicator light.

Free run: selectable by front panel switch.

Max input: $\pm 350 \text{ V}$ (dc + peak ac).

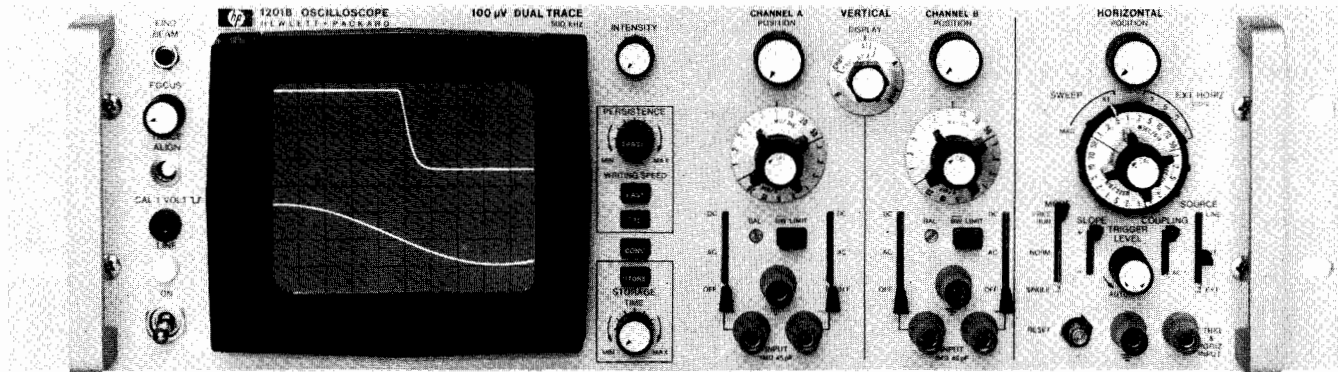

1201B

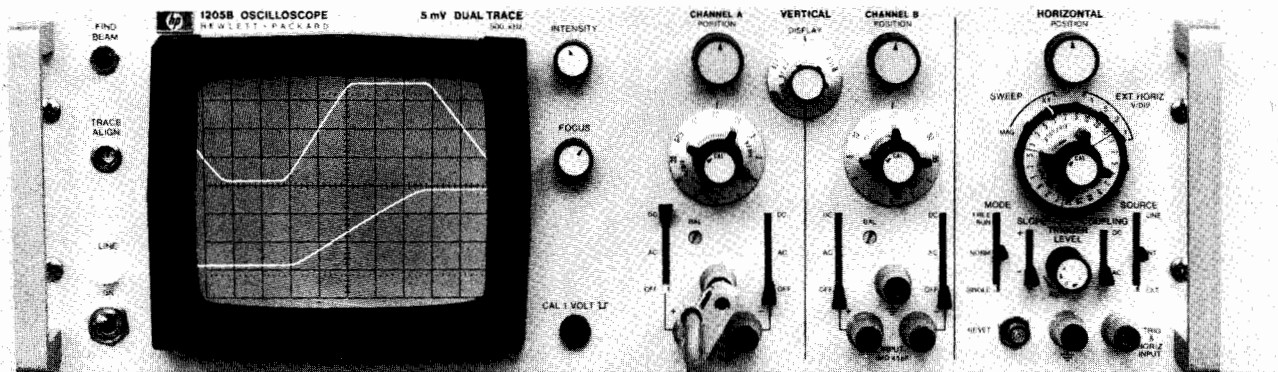

1205B

Horizontal Amplifier

Bandwidth: dc-coupled, dc to 300 kHz; ac-coupled, 2 Hz to 300 kHz.

Deflection factor: ranges, 0.1 V/div, 0.2 V/div, 0.5 V/div, and 1 V/div. Vernier, extends max deflection to at least 2.5 V/div.

Max input: ± 350 V (dc + peak ac).

Input RC: ≈ 1 M Ω shunted by ≈ 20 pF.

Input: single-ended on all ranges.

Cathode-ray Tube and Controls

Beam finder: returns trace to CRT screen.

Intensity modulation: +2 V signal blanks trace of normal intensity, +8V signal blanks any intensity trace. DC-coupled rear panel input; amplifier rise time, ≈ 200 ns; input R ≈ 5 k Ω .

Standard CRT, 1200, 1205

Type: mono-accelerator, ≈ 3000 V accelerating potential, P-31 phosphor standard.

Graticule: 8 x 10 div internal graticule, 0.2 subdivision markings on horizontal and vertical major axes; 1 div = 1 cm.

Variable Persistence Storage CRT, 1201

Type: post-accelerator, variable persistence storage tube; ≈ 10.5 kV accelerating potential; aluminized P-31 phosphor.

Graticule: 8 x 10 div internal graticule, 0.2 subdivision markings on major axes; 1 div = 0.95 cm.

Persistence Storage Characteristics

(Referenced to a centered 7 x 9 div area in STD mode and to a centered 6 x 8 div area in FAST mode.)

Persistence: conventional, ≈ 40 μ s; variable, continuously variable from 0.2 s to > 1 min., STD mode; from 0.2 s to 15 s, FAST mode.

Storage writing speed: STD, 20 div/ms; FAST, 0.5 div/ μ s.

Brightness: 343 cd/m² (100 f1) in write mode.

Storage time: STD writing speed variable from ≈ 1 min. to > 1 hr. FAST writing speed, variable from ≈ 15 s to > 15 min.

Erase: pushbutton erasure takes ≈ 1.2 s. Write gun is blanked and sweep is reset until erasure is completed.

General

Calibrator: 1 V $\pm 1.5\%$ line frequency square wave.

Size: 1200A, 298 mm H x 211 mm W x 475 mm D (11.7" x 8.3" x 18.7") 133 H x 483 W x 466 mm D overall, 423 mm D behind front panel (5.2" x 19" x 18.4"; 16.7").

Power: 115/230 V $\pm 10\%$, 48 to 440 Hz, 150 VA max.

Weight

1200A: net, 11.3 kg (25 lb); shipping, 15.6 kg (34.5 lb).

1200B, 1205B: net, 10.2 kg (22.5 lb); shipping, 15.9 kg (35 lb).

1201B: net, 12.5 kg (27.5 lb); shipping, 18.1 kg (40 lb).

Vertical Output Signal Specifications (Opt 015)

Output: 0.3 V/div $\pm 10\%$, 0 V offset unaffected by position setting.

Bandwidth: dc to 500 kHz.

Dynamic range: ± 3.5 V.

Max slewing rate: 12 V/ μ s with 300 pF load.

Min load RC: 10 k Ω shunted by ≈ 300 pF.

Source impedance: ≈ 300 Ω .

Options

006: rear input terminals wired in parallel with front panel vertical and horizontal input terminals. Vertical input shunt capacitance is increased to ≈ 100 pF. Horizontal input shunt capacitance is increased to ≈ 75 pF.

009: storage model only, remote erase through rear panel banana jack, shorting to ground provides erasure (not compatible with Opt 006).

015: vertical channel signal outputs through rear panel connectors.

910: additional Operating and Service Manual

1200A/B or 1201B

1205B

Price
add \$60

add \$25

add \$125

add \$12

add \$13

Ordering Information

1200A or 1200B Dual Channel, 100 μ V Oscilloscope

1201B Dual Channel, 100 μ V Storage Oscilloscope

1205B Dual Channel, 5 mV Oscilloscope

\$2220

\$3350

\$2050

OSCILLOSCOPES

15 MHz Dual Channel, General Purpose

Models 1220A & 1222A

- X-Y Operation
- TV Sync
- Auto or Normal trigger selection
- A \pm B Operation (1222A)
- Delay line (1222A)

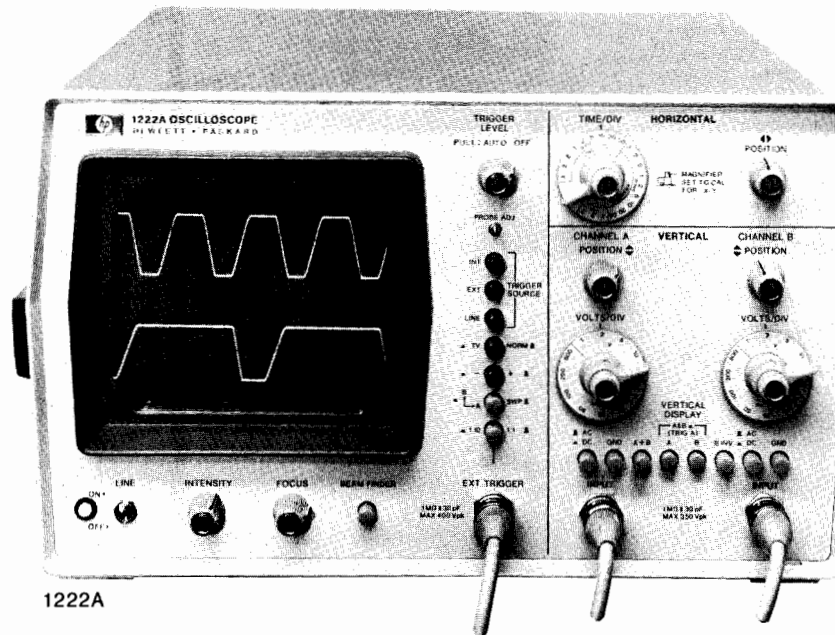

1220A, 1222A Description

Hewlett-Packard Models 1220A and 1222A dual channel 15 MHz oscilloscopes are high quality instruments with the performance necessary for a wide variety of applications. Features include a large 8 x 10 cm internal graticule for no-parallax measurements, 3% vertical attenuator accuracy, 4% horizontal accuracy, calibrated sweep times from 0.5 s/div to 0.1 μ s/div, dc coupling, automatic triggering, a sweep magnifier to expand the display up to ten times for detailed analysis, a pushbutton beam finder, X-Y display capability and TV Sync separator.

The ability to measure and compare input and output signals makes these oscilloscopes an excellent choice for basic electronic laboratories, service, production, and educational purposes. Both Models 1220A and 1222A provide selection of automatic or normal triggering. Model 1222A includes a delay line that allows viewing of the leading edge of the pulse that triggered a sweep. Measurements in the design and checkout of logic systems such as calculators and appliance controllers are easily made with the 1222A.

Easy Operation

The human engineered front panel with functionally grouped controls and color-coded pushbuttons makes measurements easier and faster. Inputs are protected to 350 V, reducing chances of accidental electrical damage. Automatic triggering assures that a base-line is present even in the absence of a signal or if the trigger level control is set beyond the range of the trigger signal. And, although the oscilloscopes operate in either a chopped or alternate mode, with automatic triggering the operator need not concern himself with making a choice since the Time/Div switch automatically selects the best display mode.

The basic stability of the solid-state circuits and components used throughout is such that internal adjustments have been reduced to a minimum. This decreases calibration requirements and provides real savings over the oscilloscope's lifetime. Recalibration, when necessary is simple and straightforward.

Triggering

Even though the instruments are easy to operate, these oscilloscopes have the flexibility for multi-purpose use. The operator can select the source of sweep trigger (internal, external, ac line, TV) and he can select the trigger slope, adding to the oscilloscope's versatility by allowing triggering on either the positive or negative going transitions

of the signal. Further flexibility is added by the ability to preset the signal amplitude required to trigger the sweep, assuring that perturbations below the desired amplitude will not trigger the oscilloscope.

With automatically triggered sweep, displays are stable because the observed signal itself determines when a sweep should start. Automatic triggering produces a free running trace in the absence of a signal for fast setup. It locks onto any input signal of the proper polarity and amplitude.

CRT

The internal 8 x 10 cm CRT graticule eliminates parallax errors that occur when the graticule is external to the CRT. The 3% vertical accuracy combined with the no-parallax graticule enables the oscilloscope to be used as a voltmeter as well as for waveform display. CRT beam intensity can be modulated through a rear panel Z-axis input.

X-Y Inputs

Phase shift measurements through the vertical amplifiers in the 1222A permit maximum measurement flexibility with the wide selection of deflection factors. In the 1220A, external signals can be applied to the horizontal deflection amplifiers. This X-Y capability permits X-Y plots for Lissajous figures with a phase shift of less than 3° to 100 kHz.

TV Sync

The built-in TV sync separator assures stable, automatic triggering on frame or line for convenient TV troubleshooting. With the instrument's times-ten magnifier, signals can be pulled out easily. The calibrated time base makes it easy to identify timing problems in vertical or horizontal TV circuits. The external horizontal input allows vector presentations of color CRT drive signals. Dual channels make it easy to set color demodulator circuits.

Rugged Lightweight Design

These oscilloscopes are, except for the CRT, entirely of solid-state design, resulting in low power consumption. The consequent low heat has made possible a rugged, lightweight cabinet with a vinyl-clad aluminum cover that is resistant to shock and moisture. A convenient side-panel handle and stabilizing feet on the opposite side make handling easy. This allows these oscilloscopes to be used in areas where ruggedness is a necessity. These areas include production lines, numerically controlled machinery, process control equipment, automotive, aircraft and marine electronics, and communications.

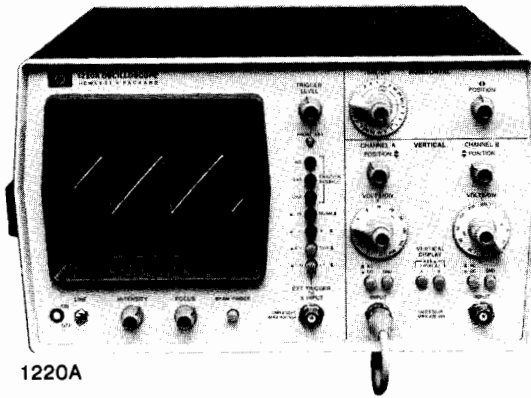

1220A

Optional Accessories

General purpose probing is provided with the Model 10013A 10:1 divider probe with an input impedance of 10 megohms shunted by only 13 pF. It extends input range to 100 V/div and multiplies input impedance without degrading frequency response. An optional front panel cover, Model 10117A, is available for protection during transportation and to provide storage space for probes and other accessories. With a rack mount kit, Model 10119A, the oscilloscopes can be mounted in only 22.2 cm (8.75 in.) of vertical space. Model 10116A light shield is available for viewing in brightly lighted areas.

1220A, 1222A Specifications

Modes of Operation

Channel A; channel B; channel B inverted (1222A); channel A \pm B (1222A); channels A and B displayed alternately on successive sweeps (Alt); triggering by A channel; channels A and B displayed by switching between channels at approx 200 kHz rate with blanking during switching (Chop). Automatic selection of alternate or chop mode—chop, at speeds from 0.5 s/div to 1 ms/div, alternate, 0.5 ms/div to 0.1 μ s/div.

Vertical Amplifiers (2)

Bandwidth (3 dB down from 50 kHz, 6 div reference signal from a terminated 50 Ω source.)

DC-coupled: dc to 15 MHz.

AC-coupled: lower limit is \approx 2 Hz.

Rise time: \approx 23 ns (measured from 10% to 90% points of 6 div input step from a terminated 50 Ω source).

Deflection Factor

Ranges: from 2 mV/div to 10 V/div (12 calibrated positions) in 1, 2, 5 sequence. \pm 3% Accuracy with vernier in cal position on 20 mV/div to 10 mV/div ranges, \pm 5% on 2 mV/div, 5 mV/div, and 10 mV/div ranges.

Vernier: extends max deflection factor to at least 25 V/div.

Polarity (1222A): Channel B may be inverted.

Signal delay (1222A): input signals are delayed sufficiently to view leading edge of input signal without advanced external trigger.

Input RC: AC or DC, \approx 1 M Ω shunted by \approx 30 pF.

Input coupling: AC, DC, or GND.

Maximum input: \pm 350 V (dc + peak ac) at \leq 1 kHz.

A + B operation (1222A): bandwidth and deflection factors are unchanged; channel B may be inverted for A - B operation.

Differential (A - B) common mode (1222A): CMR is at least 30 dB from dc to 1 MHz.

Time Base

Sweep ranges: from 0.1 μ s/div to 0.5 s/div (21 ranges) in 1, 2, 5 sequence; \pm 4% accuracy over full scale with Magnifier/Expander in calibrated position.

Sweep trigger mode: normal, sweep is triggered by internal or external signal; automatic, bright baseline displayed in absence of input signal, above \approx 10 Hz, triggering same as normal.

Triggering

Internal: \approx 2 Hz to 15 MHz on signals with \geq 1 div vertical deflection.

External: \approx 2 Hz to 15 MHz on signals of 0.1 V p-p or more.

External input RC: \approx 1 M Ω shunted by \approx 30 pF.

Line: triggers on line frequency.

TV sync: separator for + or - video, requires 1 div of video signal to trigger, automatic frame (0.5 s/div to 100 μ s/div) and line select (50 μ s/div to 0.1 μ s/div). Usable also as a low pass filter.

Level and Slope

Internal: at any point on the positive or negative slope of the displayed waveform.

External: continuously variable from +0.5 V to -0.5 V on either slope of the trigger waveform; \pm 10 extends trigger range to +5 V to -5 V.

Calibrated X-Y Operation (1222A)

Operation is via channel A (X-axis) and channel B (Y-axis).

Bandwidth: X-axis dc to 1 MHz, otherwise see Vertical Amplifiers Bandwidth specifications.

Accuracy: see Vertical Amplifiers Deflection Factor specifications. X-Y phase shift $<$ 3 $^\circ$ at 100 kHz.

Cathode-ray Tube and Controls

Type: mono-accelerator, \approx 2 kV accelerating potential, P31 phosphor.

Graticule: 8 x 10 cm internal graticule; 0.2 cm subdivisions on major horizontal and vertical axes.

Beam finder: returns trace to CRT screen.

Intensity modulation: +5 V (TTL compatible) 2 Hz to 1 MHz blanks trace of any intensity. Input R \approx 1 k Ω . Max input, 7 V rms, ac-coupled.

External Horizontal Input (1220A)

Bandwidth: dc to 1 MHz.

Coupling: dc

EXPANDER	X MODE ATTENUATOR	DEFLECTION FACTOR
Cal.	1:1	1 V/div
Cal.	1:10	10 V/div
cw	1:1	100 mV/div

Continuous adjustment between ranges by Expander.

Input RC: \approx 1 M Ω shunted by \approx 30 pF.

X-Y Phase shift: $<$ 3 $^\circ$ at 100 kHz.

General

Probe adjust: \approx 0.5 V p-p, 1 kHz square wave for adjusting probe compensation.

Power: 100, 120, 220, 240 V, \pm 10%, 60 VA max.

Weight

1220A: net, 7.3 kg (16 lb); shipping 10 kg (22 lb).

1222A: net, 7.3 kg (16 lb); shipping 10 kg (22 lb).

Size: 181 H x 311.2 W x 412.8 mm D (7.13" x 12.25" x 16.25").

Accessories furnished: one blue light filter, one power cord, one fuse for 100 V, 120 V, 220 V or 240 V operation, and one Operating and Service Manual.

Environment

Operating temperature: 0 $^\circ$ C to +45 $^\circ$ C (+32 $^\circ$ F to 113 $^\circ$ F).

Non-operating temperature: -40 $^\circ$ C to +75 $^\circ$ C (-40 $^\circ$ F to +167 $^\circ$ F).

Relative humidity: to 95% at +40 $^\circ$ C (+104 $^\circ$ F).

Altitude: to 4600 m (15 000 ft).

Vibration: vibrated in three planes for 15 minutes each with 0.254 mm (0.01 in.) excursion, 10 to 55 Hz.

Accessories Available

10116A: Light Shield. \$13

10117A: Front Panel Cover \$28

10119A: Rack Mount Kit \$120

Note: Probes are not supplied

10013A: 10:1 Divider Probe recommended \$60

Ordering Information

1220A Dual Channel Oscilloscope \$975

Opt 910: extra Operating and Service Manual add \$7

1222A Dual Channel Oscilloscope \$1050

Opt 910: extra Operating and Service Manual add \$7

OSCILLOSCOPES

Probes and Other Oscilloscope Accessories

Miniature Oscilloscope Probes

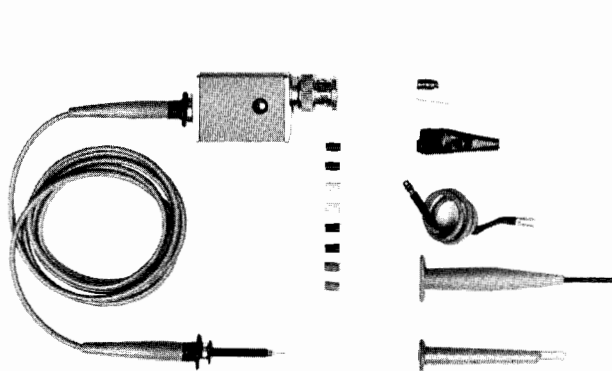

10017A, 10018A, 10040A, 10041A, 10042A

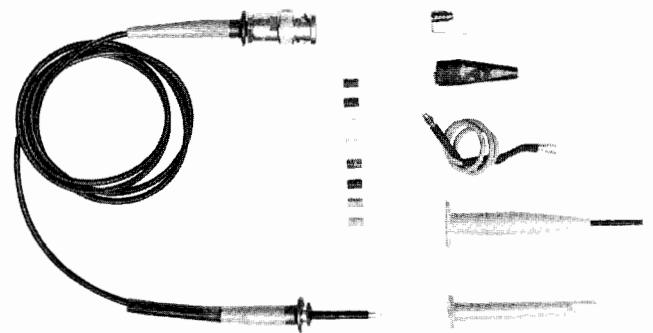

10026A, 10027A

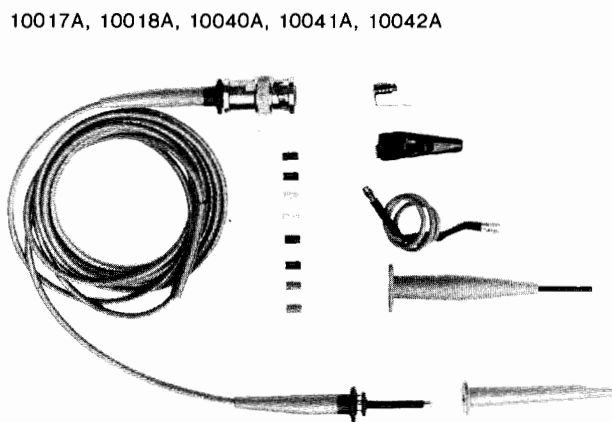

10021A, 10022A

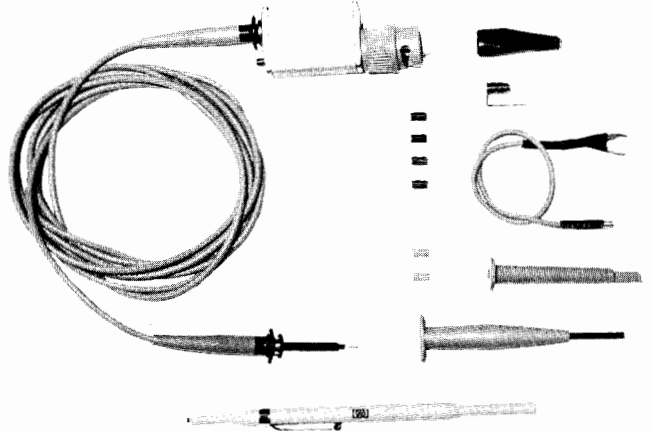

10080A, 10081A, 10082A, 10083A, 10084A

*OSCILLOSCOPE/MINIATURE PROBE COMPATIBILITY AND PROBE CHARACTERISTICS								
HP Oscilloscope/ Plug-in Model No. and Bandwidth	Probe Model No.	Approx Overall Length in Metres (ft)	Division Ratio	Input R	Shunt Capacitance	Compensates Oscilloscope Input	Max DC Volts	Price
1725A/275 MHz 1722B/275 MHz 1727A/275 MHz	10017A	1 m (3.3)	10:1	1 M Ω	8 pF	9 to 14 pF	300	\$90
1715A/200 MHz 1809A/100 MHz 1805A/100 MHz	10018A	2 m (6.6)	10:1	1 M Ω	10 pF	9 to 14 pF	300	\$90
1740A, 1741A, 1742A, 1743A, 1744A/ 100 MHz	10040A	1 m (3.3)	10:1	1 M Ω	9 pF	20 to 30 pF	300	\$95
	10041A	2 m (6.6)	10:1	1 M Ω	12 pF	20 to 26 pF	300	\$95
	10042A	3 m (9.8)	10:1	1 M Ω	15 pF	20 to 24 pF	300	\$95
1908A/B/100 MHz	10080A**	1 m (3.3)	10:1	1 M Ω	9 pF	10-20 pF	300	\$115
	10081A**	2 m (6.6)	10:1	1 M Ω	12 pF	12-20 pF	300	\$115
1950A/100 MHz	10082A**	3 m (10)	10:1	1 M Ω	14 pF	14-18 pF	300	\$115
	10083A**	1 m (3.3)	1:1		45 pF		300	\$115
	10084A**	2 m (6.6)	1:1		68 pF		300	\$115
All Scopes with high Z inputs (may reduce bandwidth)	10021A	1 m (3.3)	1:1		36 pF		300	\$60
	10022A	2 m (6.6)	1:1		62 pF		300	\$60
All Scopes with 50 Ω inputs and with a 50 Ω source impedance	10026A	1 m (3.3)	1:1	50 Ω			100	\$60
	10027A	2 m (6.6)	1:1	50 Ω			100	\$60

Accessories supplied with each probe: one retractable hook tip, one IC probe tip adapter, one alligator clip, one 20 cm (8") ground lead, eight color-coded indicator sleeves, one grounding spring, and one Operating Note.

*These miniature probes may be used with other oscilloscopes and test instruments with the proper input capacitance with no noticeable bandwidth degradation. However, due to variations of input characteristics, the probes may require recalibration for optimum performance.

**The 10080 Series miniature probes include a Feature Enable pushbutton for exclusive use with the 1980 Oscilloscope Measurement System.

Standard probes

For measurements in standard circuits where miniature probes are not a requirement, Hewlett-Packard offers a wide selection of standard size probes.

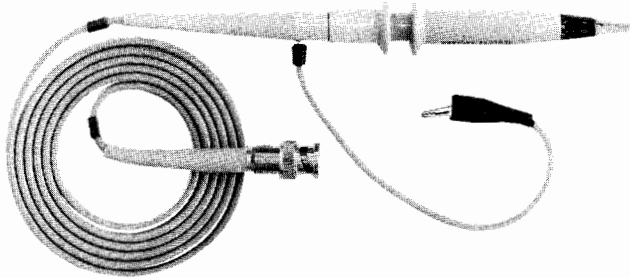

10001-10003A

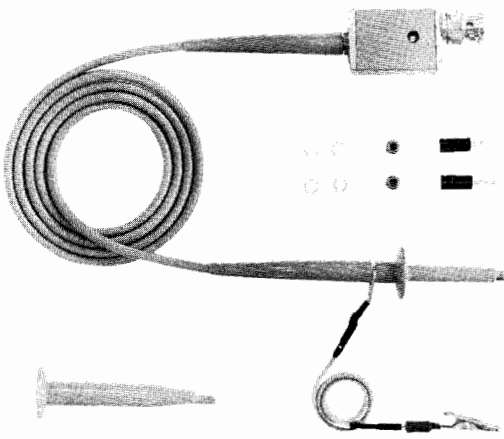

10004D-10006D, 10014A, 10016B

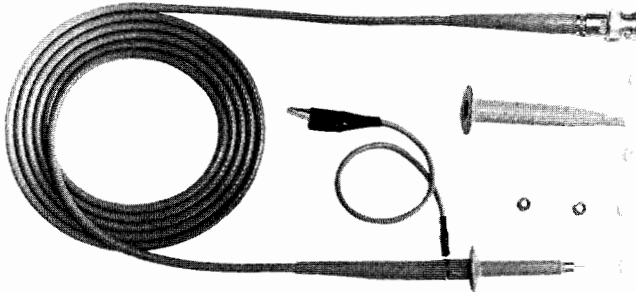

10007B, 10008B

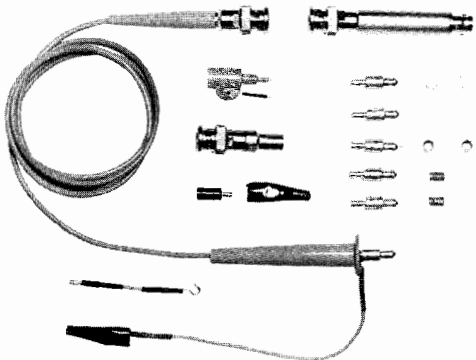

10020A

Standard Probe Instrument Compatibility

Scope/ Plug-in	1200 Series	1220 Series	1715A 1725A 1722B 1727A	1740A thru 1744A	1801A	1805A 1809A
Probe						
10001A	X	X		L	L	
10001B	X	X		L	L	
10002A	X	X		L	L	
10002B	X	X		L	L	
10003A	X	X		L	L	
10004D		X		X	X	
10005D		X		L	X	
10006D		X		X	X	
10007B	X	X	L	L	L	L
10008B	X	L	L	L	L	L
10013A	X	X			L	
10014A			X			X
10016B			X			X
10020A			X	X		X
1120A			X	X		X
1124A			L	L		L

Notes:
X Indicates that probe will maintain the bandwidth of the instrument.
L Indicates that probe may limit the bandwidth of the instrument.

Standard Divider Probe Characteristics

Model No.	Division Ratio	Resistance (M Ω)	Shunt Capacitance (pF)	Compensates Scope Input C (pF)	Max DC Volts	Overall Length m (ft)	Price
10001A	10:1	10	10	15-55	600	1.5 (5)	\$125
10001B	10:1	10	20	15-45	600	3 (10)	\$125
10002A	50:1	9	2.5	15-55	1000	1.5 (5)	\$135
10002B	50:1	9	5	15-55	1000	3 (10)	\$135
10003A	10:1	10	10	15-55	600	1.3 (4)	\$120
10004D	10:1	10	10	20-30	500	1.1 (3.5)	\$95
10005D	10:1	10	17	20-30	500	3 (10)	\$105
10006D	10:1	10	14	20-30	500	1.8 (6)	\$95
10007B	1:1	—	40	—	600	1.1 (3.5)	\$50
10008B	1:1	—	60	—	600	1.8 (6)	\$55
10013A	10:1	10	13	24-45	500	1.8 (6)	\$60
10014A	10:1	10	10	9-13	500	1.1 (3.5)	\$100
10016B	10:1	10	14	9-13	500	1.8 (6)	\$105

10020A Resistive Dividers

Division Ratio	Input R* (ohms)	Division Accuracy	Max V** (rms)	Input C (pF)
1:1	50	—	6	—
5:1	250	± 3%	9	<0.7
10:1	500	± 3%	12	<0.7
20:1	1000	± 3%	15	<0.7
50:1	2500	± 3%	25	<0.7
100:1	5000	± 3%	35	<0.7

*When terminated in 50 ohms.
**Limited by power dissipation of resistive element.

Probe length (overall): \approx 1.2 m (4 ft).
Weight: net, 0.45 kg (1 lb); shipping, 1.4 kg (3 lb).
Accessories supplied: blocking capacitor, BNC adapter tip, 6-32 adapter tip, alligator tip, probe handle, cable assy's 5.1 cm (2 in.) & 15.2 cm (6 in.) ground, spanner tip, insulating caps, colored sleeves.

10020A Resistive Divider Probe Kit

\$260

OSCILLOSCOPES

Probes and Other Accessories (Cont.)

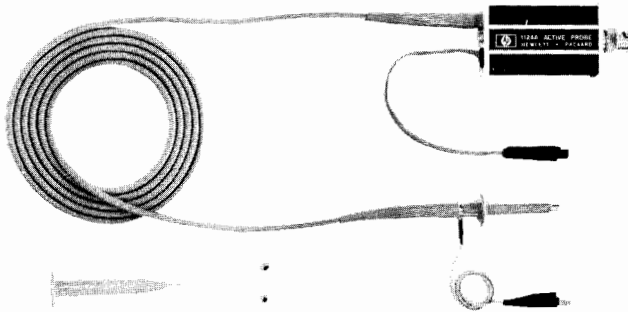

1124A

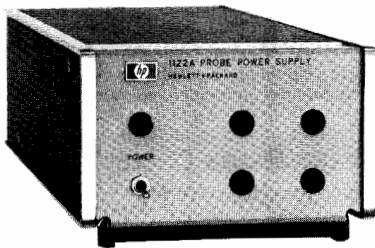

1122A

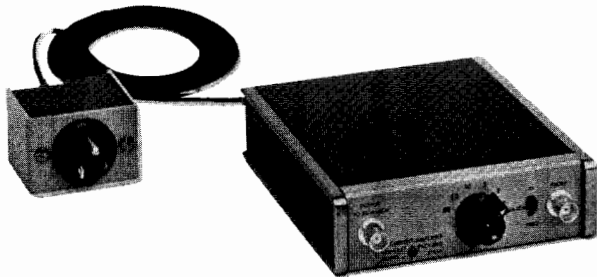

1111A

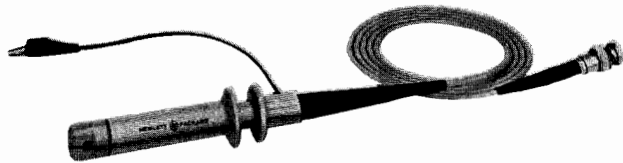

1110B

1124A 100 MHz Active Probe

Model 1124A Active Divider Probe provides high voltage, general purpose probing capabilities for instruments having 50 ohm inputs without selectable high impedance inputs. This 10 megohm 10 pF probe allows direct measurements of 100 volts, in the 100:1 division ratio mode, from dc to 100 MHz. In the 10:1 division ratio mode, input voltage range is ± 10 volts. Power is supplied by instruments with probe power jacks or the 1122A probe power supply.

1124A Specifications

(Measured when connected to a 50 Ω load.)

Bandwidth: (measured from a terminated 50 Ω source) dc-coupled,

dc to 100 MHz; ac-coupled, 2 Hz to 100 MHz.

Pulse response: (measured from a terminated 50 Ω source) transition time, <3.5 ns; perturbations, 5% p-p. Measured with pulse transition time of >2.5 ns.

Attenuation ratio: 10:1 $\pm 5\%$; 100:1 $\pm 5\%$.

Dynamic range: X10, ± 10 V; X100, ± 100 V.

Input RC: 10 M Ω shunted by ≈ 10 pF.

Maximum safe input

DC-coupled: X10, ± 300 V (dc + peak ac) ≤ 100 MHz; X100, ± 500 V (dc + peak ac) ≤ 100 MHz.

AC-coupled: X10, ± 300 V (dc + peak ac) ≤ 100 MHz. DC component must not exceed ± 200 V; X100, ± 500 V (dc + peak ac) ≤ 100 MHz. DC component must not exceed ± 200 V.

Accessories supplied: one 20.3 cm (8 in.) ground lead, one retractable hook tip, and two probe tip insulating caps.

Power: supplied by instruments with probe power jacks or Model 1122A probe power supply.

Weight: net, 0.2 kg (5 oz.); shipping, 0.91 kg (2 lb).

Length: ≈ 1.5 m (5 ft) overall.

Available accessory: 10131B 91.4 cm (36 in.) extender cable (refer to 1122A Probe Power Supply). Required for use with 1700 oscilloscopes with probe power option.

1122A Probe Power Supply

Model 1122A is a regulated power supply that provides all power requirements for simultaneous operation of up to four active probes.

1122A Specifications

Probe driving capability: up to four HP active probes.

Power output: -12.6 V and +15 V, $\pm 3\%$.

Power input: 115 V or 230 V $\pm 10\%$, 48 to 440 Hz, 40 W (with four probes).

Weight: net, 2.7 kg (6 lb); shipping, 3.6 kg (8 lb).

Accessories supplied: four Model 10131B 91.4 cm (36 in.) extender cables.

1111A AC Current Amplifier

Deflection factor: (with a 50 mV/div oscilloscope deflection factor) in X1, 1 mA/div to 50 mA/div; in X100, 100 mA/div to 5 A/div; 1, 2, 5 sequence in X1 or X100.

Accuracy: in X1, $\pm 3\%$; in X100, $\pm 4\%$.

Rise time: 18 ns.

Noise: <100 μ A p-p, referenced to input signal.

Maximum ac current: above 700 Hz, 50 A p-p; below 700 Hz, decreases at 1.4 A/20 Hz.

Output impedance: 50 Ω .

Size: 38.1 H \times 130.2 W \times 152.4 mm D (1 $\frac{1}{2}$ " \times 5 $\frac{1}{8}$ " \times 6").

Weight: net, ≈ 0.9 kg (2 lb); shipping, 1.4 kg (3 lb).

Power: 115 or 230 V $\pm 10\%$, 50 to 440 Hz, 1.5 watts.

1110B Current Probe

Sensitivity: without 100 Ω termination, 1 mV/mA; with 100 Ω termination, 0.5 mV/mA.

Accuracy: $\pm 3\%$.

Bandwidth

Lower -3 dB point: without 100 Ω termination, ≈ 1700 Hz; with 100 Ω termination, ≈ 850 Hz.

Upper -3 dB point: with 4 pF capacitive load, ≈ 45 MHz; with 30 pF capacitive load ≈ 35 MHz.

Rise time: with 4 pF capacitive load, ≈ 7 ns; with 30 pF capacitive load, ≈ 9 ns.

Insertion impedance: $\approx 0.01\Omega$ shunted by 1 μ H; capacitance to ground <3 pF.

Maximum dc current: 0.5 A.

Maximum ac current: 15 A p-p above 4 kHz; decreasing below 4 kHz at 3.8 A/kHz rate.

Weight: net, 0.5 kg (1 lb); shipping, 0.9 kg (2 lb).

Dimensions: probe aperture, 3.9 mm ($\frac{3}{32}$ " diameter; overall length, 1.5 m (5 ft).

Ordering Information

1122A Probe Power Supply

1124A 100 MHz Active Probe

1111A Current Amplifier

1110B Current Probe

Price

\$700

\$275

\$750

\$400

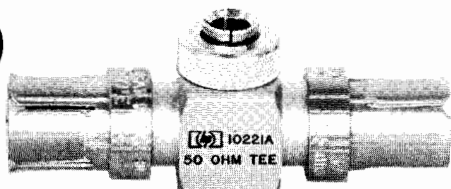

10221A
Model 10221A 50 ohm Probing Tee

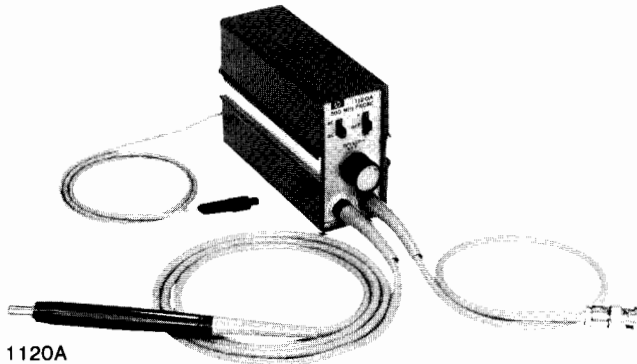

1120A

1120A 500 MHz Active Probe

For probing high source impedances at high frequencies, the Model 1120A 1:1 active probe provides a probe tip impedance of 100 k Ω shunted by approx 3 pF at 100 MHz. When used with the 10:1 or 100:1 divider tips, the shunt capacitance is <1 pF at 100 MHz. The 50 ohm output provides the optimum impedance match and measurement accuracy for oscilloscopes, spectrum analyzers, counters, and network analyzers with 50 ohm inputs. Power is supplied by instruments with probe power jacks or the 1122A probe power supply.

1120A Specifications

(Measured with output connected to a 50 Ω load.)

Bandwidth: (measured from a terminated 50 Ω source) dc-coupled, dc to >500 MHz; ac-coupled, <1.5 kHz to >500 MHz.

Pulse response: (measured from a terminated 50 Ω source) transition time, <0.75 ns; perturbations, < $\pm 6\%$ measured with 1 GHz sampler.

Dynamic range: ± 0.5 V with ± 5 V dc offset.

Noise: ≈ 2.5 mV (measured tangentially).

Input RC: 100 k Ω , shunt capacitance ≈ 3 pF at 100 MHz; with 10:1 or 100:1 dividers, shunt capacitance is <1 pF at 100 MHz.

Maximum input: ± 80 V.

Weight: net, 1.8 kg (4 lb); shipping, 3.2 kg (7 lb).

Power: supplied by oscilloscopes with probe power jacks or a Model 1122A probe power supply.

Length: 1.2 m (4 ft) overall; with Option 001, 1.8 m (6 ft).

Accessories Furnished

Model 10241A 10:1 divider: increases input R to ≈ 1 M Ω shunted by <1 pF at 100 MHz.

Model 10243A 100:1 divider: increases input R to ≈ 1 M Ω shunted by <1 pF at 100 MHz.

Model 10242A bandwidth limiter: reduces bandwidth to ≈ 27 MHz shunted by ≈ 6 pF and reduces gain <2%.

Also included: slip-on hook tip, 6.4 cm (2.5 in.) ground lead, spare probe tips, a slip-on BNC probe adapter, and a probe divider adjustment tool (PN 5020-0570).

Ordering Information

1120A 500 MHz Active Probe
1120A Opt 001, 1.8 m (6 ft) length
10221A 50 ohm Probing Tee

Price

\$850
add \$35
\$250

Probe Accessories

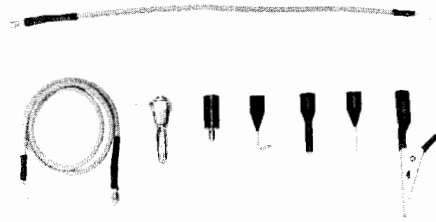

10034A

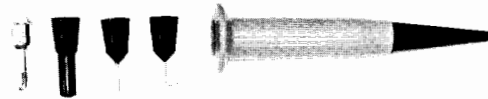

10035A

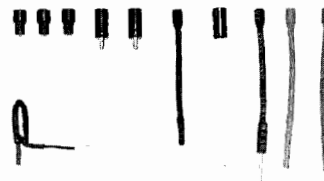

10036B

10034A Ground Lead Kit

Model 10034A probe adapter kit consists of an assortment of 6-32 screw-on tips, and two ground lead cables which allow many methods of connecting the ground leads in a circuit. A 6-32 to slip-on adapter allows these tips to be used on 10004D-10006D, 10007B, 10008B, 10013A, 10014A, 10016B, and 1124A probes. The kit consists of one 15.2 cm (6 in.) and one 30.5 cm (12 in.) ground lead, one hook tip, one alligator tip, one pin tip, one tip for 0.6 mm (0.025 in.) square pins, one banana tip, and one slip-on to 6-32 adapter.

10035A Probe Tip Kit

The tips in this kit are designed to be used with probes that accept a No. 6-32 screw-on tip which include: Models 10001A/B, 10002A/B, and 10003A. A slip on to 6-32 adapter allows these tips to be used with other probes with pin tips. The adapter is supplied with 10004D through 10006D, 10014A, 10016B, 10020A Probes, and 10034A Ground Lead Kit. Model 10035A Probe Tip Kit contains a pincer jaw, banana tip, pin tip, and spring tip.

10036B Probe Tip Kit

The tips in this kit extend the usefulness of standard probes that accept slip-on tips, and the Easy IC Miniature Probes. Included in the kit are two slip-on to 6-32 adapters and three bushing adapters that provide the flexibility to use the supplied tips with both types of probes. The adapters also allow use of other 6-32 probe tips with the probes. Model 10036B includes an assortment of tips for the following: 2.0 mm (0.08 in.) jack; 0.6 mm (0.025 in.) and 1.14 (0.045 in.) square pin; 1.0 mm-1.6 mm (0.040-0.062 in.) dia pin.

10037B Probe Tip Kit

Model 10037B Probe Tip Kit contains six 0.64 mm (0.025 in.) square female (white) tips for standard probes that accept slip-on tips, and the Easy IC Miniature Probes. Also included are six bushings that adapt HP miniature probes to the supplied tips.

Ordering Information

10034A Ground Lead Kit
10035A Probe Tip Kit
10036B Probe Tip Kit
10037B Probe Tip Kit

Price

\$35
\$20
\$55
\$60

OSCILLOSCOPES

Probes and Other Accessories (Cont.)

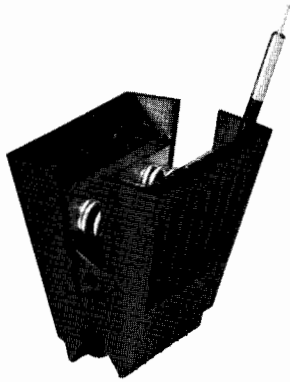

10024A IC Test Clip

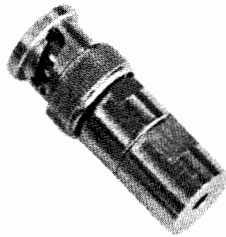
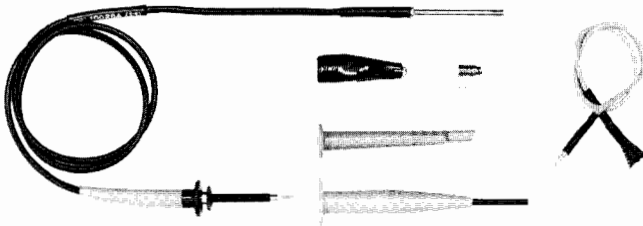
BNC to Probe Adapter
1250-1454

10028A Jumper Cable is supplied with a slip-on IC probe tip adapter for easy access to IC pins.

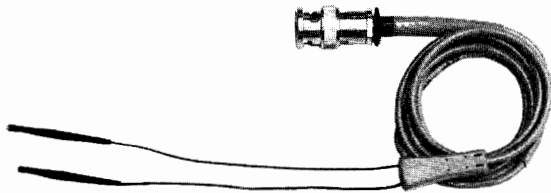

10019A Cable Assembly



10017-67603 Coaxial Adapter Cable



10017-67604 Mini to Standard Probe Adapter

Miniature Probe Accessories

10024A IC Test Clip

Model 10024A IC Test Clip provides easy probing of dual in-line packages and includes four insulated circuit interface pins. Additional circuit interface pins are available (see Ordering Information) in packages of twelve pins. Each pin has a tip on each end so that probes such as those on HP Logic Analyzers can be connected for fast, functional checks of circuit operation.

10036B and 10037B Probe Tip Kits

Models 10036B and 10037B probe tip kits increase probing versatility with an assortment of 6/32 screw-on tips. Slip-on to 6/32 adapters are included for compatibility with the miniature probes.

10028A Jumper Cable

Model 10028A 50 ohm 610 mm (24 in.) miniature probe/jumper cable is designed primarily for bypassing suspected faulty circuits in densely populated IC circuits. The basic tip on either end of the cable inserts directly into a 10024A IC Test Clip, allowing easy temporary connections between IC's without the danger of shorting between pins. The cable can also be used as a 50 ohm 1:1 probe to insert signals from an external source or as an input source to an external measuring device. For the latter uses, Probe Tip to BNC Adapter (HP P/N 1250-1454) is available.

10019A BNC to Square Pin Cable Assembly

Model 10019A cable assembly is designed for connecting test equipment to 0.64 mm–0.76 mm (0.025 in.–0.030 in.) square pin signal nodes or to integrated circuits through the 10024A IC Test Clip. This adaptable cable assembly is primarily used as:

a. A signal pick-off device for applying circuit signals to the input of test equipment such as oscilloscopes, voltmeters, etc. An application is the checking of voltages on computer back plane pins.

b. A signal insertion cable for inserting signals into suspected faulty circuits from power supplies, pulse generators, etc. Used in conjunction with Model 10024A IC Test Clip, signals are easily inserted into the proper IC leads.

For applications requiring greater separation between the circuit nodes and the instrumentation, the 10019A may be extended by using a BNC to BNC adapter (HP P/N 1250-0080) and a 50 ohm test cable such as the 122 cm (48 in.) Model 11170C. And when the test equipment hookup requires a dual banana plug, BNC to Dual Banana Plug Adapter (HP P/N 1251-2277) is available.

10017-67603 Coaxial Adapter Cable

HP P/N 10017-67603 is a 230 mm (9 in.) 50 ohm slip-on adapter cable for miniature and standard HP probes that provides a coaxial interface to 0.64 mm (0.025 in.) square pin circuit nodes. The cable is ideal for probing computer back planes as well as wire wrap terminals. HP P/N 10017-67604 mini to standard probe adapter allows the cable to slip directly onto the HP Easy IC Miniature Probe tip with the insulating barrel removed.

10017-67604 Mini to Standard Probe Adapter

HP P/N 10017-67604 allows standard size slip-on probe tip accessories to be used with HP miniature probes. With the retractable insulating barrel removed from the miniature probe and replaced with the 10017-67604 adapter, the probe slides directly into the standard size probe tip accessories.

Digital Trigger Probes

Model 10250A (TTL) 4 bit Trigger Probe is a useful service, production, and design troubleshooting tool that offers digital pattern triggering to enhance the use of oscilloscopes, logic analyzers, and other test equipment. The four inputs may be switched to HI, LO, or OFF (don't care) for convenient selection of the trigger point. No separate power supply is needed because probe power is obtained from the circuit under test.

Ordering Information

	Price
10024A IC Test Clip for easy probing of dual in-line packages; includes 4 insulated circuit interface pins	\$15
10024-69501 Interface Pin Kit for 10024A; includes 12 interface pins	\$30
1250-1454 BNC to probe adapter permits the miniature probes to be connected to BNC connectors to maintain fast pulse response.	\$11
10036B Probe Tip Kit	\$55
10037B Probe Tip Kit	\$70
10028A Jumper Cable	\$55
10019A Cable Assembly	\$40
10017-67603 Coaxial Adapter Cable	\$25
10017-67604 Mini to Standard Probe Adapter	\$15
10250A Trigger Probe (TTL)	\$125

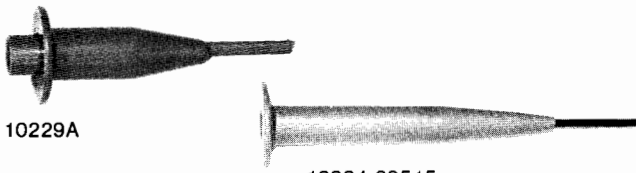

10229A

10004-69515

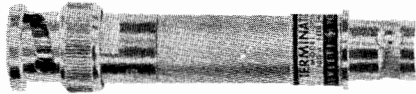

10100B

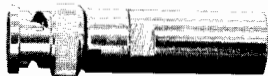

10011B



10100C

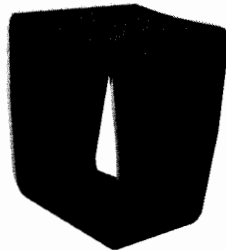

10116A



10140A

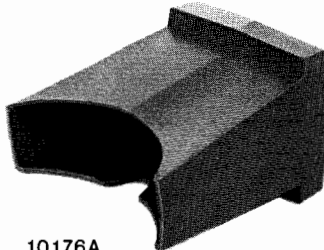

10176A

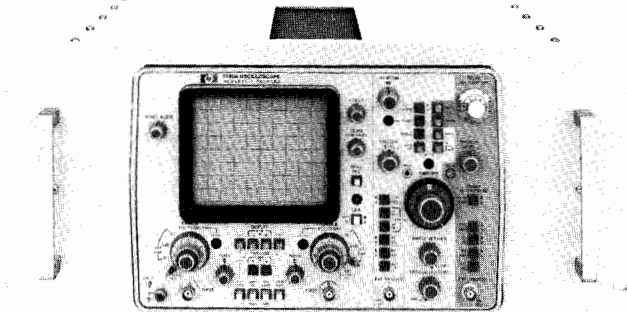

10491B

Probe Accessories

Terminations

10100C: 50 Ω \pm 1% BNC male to BNC female feedthrough termination.

10100B: 100 Ω \pm 2 Ω BNC male to BNC female feedthrough termination.

Standard Probe Tip Adapters

10011B slip-on to BNC probe tip adapter: for probes 10004D-10006D, 10007B, 10008B, 10013A, 10014A, 10016B, and 1124A.

10229A hook tip adapter: retractable pincer tip provides firm connection to circuit nodes. Supplied with 1120A probe. Recommended accessory for 10020A Resistive Divider Kit.

HP P/N 10004-69515 IC probe tip adapter: retractable pincers provide convenient connection to dual in-line packages for probes 10004D-10006D, 10007B, 10008B, 10013A, 10014A, 10016B, and 1124A. Supplied with 10004D, 10005D, 10006D, 10014A, and 10016B.

Servicing and Viewing Accessories

Plug-in Extender

Model 10407B: 180 system extender (metal frame extends both plug-ins). Allows calibration while a unit is operating.

Viewing Hoods

10116A: collapsible light shield for 1220 series oscilloscopes.

10140A: collapsible viewing hood for 1700 series oscilloscopes.

10176A: viewing hood for 12.7 cm (5 in.) rectangular CRT bezels.

Light Filters

10173A: RFI filter and contrast screen for 1700 series oscilloscopes.

10178A: metal mesh contrast screen for 181, 184 oscilloscopes.

Amber plastic filter: HP P/N 5020-0530, for 12.7 cm (5 in.) rectangular CRT (180 style).

Smoke gray plastic filter: HP P/N 5020-0567, for 12.7 cm (5 in.) rectangular CRT (180 style).

Blue plastic filter: HP P/N 5060-0548, for 12.7 cm (5 in.) rectangular CRT (180 style).

Blue light filter: HP P/N 01740-02701 for 1700 series oscilloscopes.

Rack Mount Slides and Adapters

1700 series oscilloscopes

10491B rack mount adapter: adapts 1700 series oscilloscopes to standard 483 mm (19") rack; 222 mm (8 3/4") high, 540 mm (21 1/4") deep. Requires fixed slides (HP P/N 1490-0714) or pivoted slides (HP P/N 1490-0719) for slide mounting.

180 and 181 rack style oscilloscopes

A slide adapter is required to secure an oscilloscope to the slides.

Fixed slides: HP P/N 1490-0714, 55.9 cm (22").

Pivot slides: HP P/N 1490-0719, 55.9 cm (22").

Slide adapter: HP P/N 1490-0768 (required for all slides).

Front Panel Covers

10166A: provides front panel protection for 180A, 181A, 184A oscilloscopes.

HP P/N 5040-0516: provides front panel protection for 1700 series oscilloscopes.

Ordering Information

	Price
10229A Retractable Hook Tip Adapter	\$15
10004-69515 IC Probe Tip Adapter	\$12
10011B BNC Probe Tip Adapter	\$12
10100C 50 Ω Feedthrough Termination	\$25
10100B 100 Ω (\pm 2 Ω) Feedthrough Termination	\$45
10407B Plug-in Extender	\$300
10116A Light Shield for 1220 series oscilloscopes	\$20
10140A Viewing Hood for 1700 series (8 x 10 div. CRT)	\$25
10166A Front Panel Cover for 180A, 181A, 184A oscilloscopes	\$180
10176A Viewing Hood for 12.7 cm (5 in.) rect. CRT	\$25
10173A RFI Filter and Contrast Screen for 1700 series oscilloscopes (8 x 10 div. CRT)	\$25
10178A Metal Mesh Contrast Screen for 181, 184 oscilloscopes	\$30
5020-0530 Amber Plastic Filter for 12.7 cm (5 in.) rectangular CRT	\$12.00
5020-0567 Smoke Gray Plastic Filter for 12.7 cm (5 in.) rectangular CRT.	\$23.50
5060-0548 Blue Plastic Filter for 12.7 cm (5 in.) rectangular CRT	\$11.00
01740-02701 Blue Light Filter for 1700 series oscilloscopes (8 x 10 div. CRT)	\$8.50
10491B Rack Adapter for 1700 series oscilloscopes.	\$195.00
1490-0714 Fixed Slides for 180, 181 rack style oscilloscopes and 10491B	\$125.00
1490-0719 Pivoted Slides for 180, 181 rack style oscilloscopes and 10491B	\$185.00
1490-0768 Slide Adapter, required for securing slides to 180, 181 rack style oscilloscopes	\$150.00
5040-0516 Front Panel Cover for 1700 series oscilloscopes.	\$12.50

OSCILLOSCOPES

Probes and Other Accessories (Cont.)

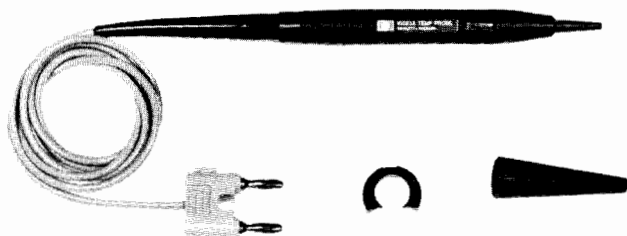

10023A

10023A Temperature Probe

The Model 10023A Temperature Probe provides fast, accurate temperature measurements in a variety of thermal design, diagnostic, and testing applications. Surface temperatures are read directly in degrees Celsius on multimeters (DMM) having an input impedance of ≥ 10 megohms. A pencil-like probe tip easily accesses small components and a press-to-read switch make measurements easy; just press the button touch the surface to be measured, and read its temperature directly on the DMM.

The probe is a self-contained temperature-to-voltage transducer with a forward-biased diode chip bonded to a small ceramic substrate in the probe tip. A calibrated, linear output of $1 \text{ mV}/^\circ\text{C}$ is assured by individually characterizing each diode in a precision thermal reference bath. An integrated circuit resistor network is then laser trimmed to match each diode to its electronic compensation circuit.

The entire electronics assembly, including the battery, is packaged in the probe barrel. A standard dual banana plug output connector provides universal readout through most digital voltmeters including the built-in DMMs on HP's Option 034/035, 1700 Series oscilloscopes.

10023A Specifications

Electrical

Measurement Range: -55°C to $+150^\circ\text{C}$.

Output: $1 \text{ mV}/^\circ\text{C}$.

Short Term Repeatability: $\pm 0.3^\circ\text{C}$ (minimum of 48 hrs).

Accuracy: $\pm 2^\circ\text{C}$ from 0°C to 100°C , decreasing linearly to $+2^\circ\text{C}$, -4°C at -55°C and $+4^\circ\text{C}$, -2°C at $+150^\circ\text{C}$.

Maximum Voltage at Tip: 600 V (dc + peak ac).

Tip Capacitance to Ground: approx 0.5 pF.

Thermal Response: $< 3\text{s}$ to settle within 2°C of final reading (liquid measurement) for a 100°C temperature change.

DMM Input R: $\geq 10 \text{ M}\Omega$.

General

Operating Environment probe tip to approx 13 mm (0.5 in.) from probe tip: temperature, -55°C to $+150^\circ\text{C}$; altitude, to 4600 m (15,000 ft); vibration, vibrated in three planes for 15 min. each with 0.38 mm (0.015 in.) excursion, 10 to 55 Hz.

Operating Environment (probe body): temperature, 0°C to 60°C (battery limitation); humidity (non-condensing), to 95% relative humidity at $+40^\circ\text{C}$, altitude and vibration same as those for probe tip.

Overall Length: approx 1.4 m (53 in.).

Weight: net, 85 g (3 oz); shipping, 312 g (11 oz).

Battery Life: approx 50 hr (varies with ambient temperature).

Low Battery Indication: probe output indicates approx -70°C on DMM. First indication of a low battery condition is a decreasing indication of 1° to $2^\circ\text{C}/\text{minute}$ with probe tip at a constant temperature.

Accessories Supplied: one replacement battery (1420-0256), one sliding lock collar (10023-23201), and one probe tip cover (00547-40005).

Replacement Batteries: batteries may be purchased locally using the following part numbers, RAY-O-VAC^{®1}, RS 312-G or T-312-G; DURACELL^{®2} 10L125; or batteries with similar specifications.

^{®1}RAY-O-VAC is a registered trademark of ESB, Inc.

^{®2}DURACELL is a registered trademark of P. R. Mallory & CO.

Ordering Information

Ordering Information	Price
10023A Temperature Probe	\$150
10023-60001 Replacement Tip, includes pre-calibrated tip and matching compensation network	\$60

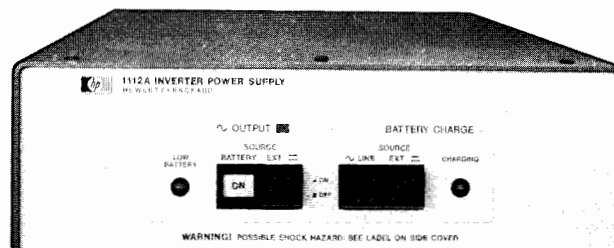

1112A Specifications

Output

Voltage: 120 or 240 V ac, peak-to-peak output is fixed at 285 V; rms value changes with load; minimum usable load, 20 W.

Load	120 V Range		240 V Range	
	400 Hz	60 Hz*	400 Hz	60 Hz*
65 W	$\geq 96 \text{ V rms}$	$\geq 99 \text{ V rms}$	$\geq 192 \text{ V rms}$	$\geq 198 \text{ V rms}$
20 W	$\leq 126 \text{ V rms}$	$\leq 126 \text{ V rms}$	$\leq 250 \text{ V rms}$	$\leq 250 \text{ V rms}$

*With Option 060

Waveform: duty cycle is 50% for loads of 40 W, increasing to 65% as the load decreases to 20 W.

Frequency: $400 \text{ Hz} \pm 10\%$ (Opt 060, $60 \text{ Hz} \pm 0.5 \text{ Hz}$).

Max power: 65 W nominal, compatible with line voltage and 60 to 70 VA load requirements of HP 1700 series oscilloscopes.

Operating time: ≈ 140 watt hours with a fully charged battery pack at 25°C .

Input power: External dc source; 11.5 V to 50 V (Opt 060, 12V to 50V), at least 90 watts; External ac source; 100 V to 120 V or 220 V to 240 V, $+5\%$, -10% ; 48 to 66 Hz; 250 VA max; AC feedthrough operation; output voltage and frequency is the same as the input; output power, 120 VA max.

Battery charging: AC input; full charge in 14 hrs at $+25^\circ\text{C}$ with 120 V rms input (80% in 8 hrs); DC input: full charge in 24 hrs at $+25^\circ\text{C}$ with 18 watts input.

General

Size: 92 H x 273 W x 403 mm D ($3\frac{3}{8}$ " x $10\frac{3}{4}$ " x $15\frac{3}{8}$ ").

Weight: net, 9.1 kg (20 lb) with battery pack, 4.5 kg (10 lb) without battery pack; shipping, 10. kg (22 lb) with battery pack, 5.4 kg (12 lb) without battery pack.

Compatibility: HP 1700 Series Oscilloscopes. For compatibility with other instruments call your HP Field Engineer.

Operating environment: temperature, 0 to $+55^\circ\text{C}$ ($+32^\circ\text{F}$ to $+130^\circ\text{F}$), non-operating -40°C to $+55^\circ\text{C}$ (-40°F to $+130^\circ\text{F}$); humidity, to 95% relative humidity at $+40^\circ\text{C}$ ($+104^\circ\text{F}$); altitude, to 4600 m (15 000 ft); vibration, vibrated in three planes for 15 min. each with 0.38 mm (0.015 in.) excursion, 10 to 55 Hz.

Accessories supplied: one Model 10421A battery pack, one mounting bracket kit, one 2.3 m (7.5 ft) power cord, one 2.1 m (7 ft) grounding cable, and one operating and service manual.

1112A Accessories

10421A Battery pack: the battery pack consists of 30 size "D" nickel cadmium cells and includes temperature sensors to reduce the possibility of cell damage during charging (supplied with 1112A).

Weight: net, 4.4 kg (10 $\frac{1}{4}$ lb); shipping, 5.3 kg (11 $\frac{1}{4}$ lb).

01112-61605 Grounding cable: grounds inverter and oscilloscope chassis (supplied with 1112A).

01112-69501 Mounting bracket kit: for mounting the 1112A on top or bottom of 1700 series oscilloscopes (supplied with 1112A).

Ordering Information

Ordering Information	Price
1112A Inverter power supply (400 Hz)	\$1350
Opt 001: without battery pack	less \$400
Opt 002: without mounting bracket kit	less \$25
Opt 060: 60 Hz output frequency, internal battery operation reduced to 120 watt hours	add \$125
10421A Battery pack	\$500
01112-61605 Grounding cable	\$11
01112-69501 Mounting bracket kit	\$85

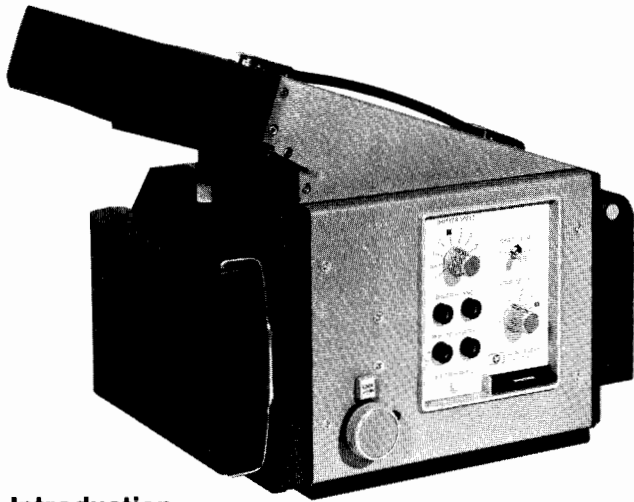

Introduction

Model 197B is a versatile, general purpose instrument for cathode-ray tube photographic recording. The camera features lift-off mounting and swing-away hinging by pressing a single latch release button. Interchangeable film backs enable capture of CRT display information on a complete spectrum of Polaroid® or conventional sheet, pack, or roll film. All controls are located outside of the camera for easy reading and fast adjustment during setup. A low-angle viewing port provides a direct view of the display through a flexible facemask while the camera is in the photographic position.

A combination split-image focusing plate and image reduction ratio scale is included and is stored in a convenient pocket underneath the camera. The reduction ratio scale provides 1:1, 1:0.9, and 1:0.7 reference settings for displays with one centimetre graticule spacing. Corner marks on the focusing plate allow the usable film area to be accurately identified. The optional Graflok® back is equipped with a ground glass focusing plate and a snap-out viewing hood.

Model 197B camera incorporates an electronically controlled shutter with eight exposure times from 1/30 to 4 seconds. Time (T) and bulb (B) control settings are also provided. The camera lens opening is continuously adjustable from f/1.9 to f/16. The 75 mm, high transmission lens provides high resolution, low distortion photographs for capturing a wide range of images.

Camera Mounting

On initial order, the 197B can be configured, with different camera adapters, to directly mount on a variety of instruments as listed in the 197B Camera Compatibility Table. Each camera adapter is attached to the camera body with a piano hinge and is an integral part of the camera. Model 197B includes a 10376A adapter which directly interfaces to 1700 Series oscilloscopes with 8 x 10 division CRTs. Model 197B Option 002 includes a 10378A adapter which directly interfaces to 180 Series oscilloscopes (except 182 models which also require an additional 10367A camera bezel adapter). Model 197B Option 006 includes a 10375A adapter which directly interfaces with the majority of HP small screen CRT displays.

By using camera bezel adapters, various camera configurations can be adapted to other instruments not directly compatible with the camera adapter. For mounting a variety of cameras to instruments both current and those no longer in production, refer to the 197B Camera Data Sheet. Copies of the 197B Data Sheet can be obtained from your local HP field office or by writing: Inquires Manager, Hewlett-Packard Company, 1507 Page Mill Road, Palo Alto, California 94304.

197B Characteristics

Reduction ratio: continuously adjustable from 1:1 to 1:0.7. Reference scale provided on focus plate.

Lens: 75 mm, f/1.9 high transmission lens; aperture, f/1.9 to f/16.

*Registered Trademark of Polaroid, Inc.
*Registered Trademark of Graflex, Inc.

197B Camera Compatibility			
Instrument	197B	197B Opt 002	197B Opt 006
Oscilloscopes			
1200/01/05		X	
1740 Series	X		
1715A/22B/25A/27A	X		
180/181		X	
182		Add 10367A	
1980			X
Displays			
1332/33/35/36/40			X (3)
Network Analyzers			
8412A		X (4)	
8414A		X	
8505A			X (3)
8754A		(1)	
Signal Analyzers			
140T/180TR		X (2)	
141T/181T/TR		X	
182T		Add 10367A (2)	
3580A		X	
3582A/85A			X (3)
3720A/21A		X	
5420A/23A			X (3)
8565A/66A/68A			X (3)

Notes:

- Model 8754A CRT has P39 phosphor. Ultraviolet light does not excite P39 phosphor and will not illuminate an internal graticule. However, the 197B Opt 002 physically fits on the 8754A.
- These instruments have P39 phosphor with internal graticule illumination supplied by internal CRT floodguns.
- These instruments have Lexan CRT faceplates that attenuate ultraviolet light and will not allow illumination of an internal graticule. Instruments with internal floodguns provide internal graticule illumination.
- Model 8412A CRT has P7 phosphor and the ultraviolet camera light source does not illuminate the phosphor very well and there is no internal CRT floodgun for graticule illumination.

Shutter speeds: 1/30, 1/15, 1/8, 1/4, 1/2, 1, 2, 4 seconds. Time and Bulb; shutter has a sync contact closure output for triggering external equipment and an input jack for remote operation.

Camera back: 83 mm x 108 mm (3.25" x 4.25") Polaroid pack back (Graflok back is available, see Options).

Mounting: lift on/off mounting with positive lock, swing-away hinging to left.

Viewing: low-angle, direct viewing through a flexible facemask.

Shutter open indicator: illuminated whenever shutter is open.

Ultraviolet illumination: light source and lens filter provide graticule illumination and photographic speed enhancement.

Focus: adjustable with lock; split-image focusing plate provided.

Size: 267 H x 194 W x 356 mm D (10.5" x 7.6" x 14").

Weight: net, 4.5 kg (10 lb); shipping, 7.3 kg (16 lb).

Power: switch selectable 115 Vac ± 10% or 230 Vac ± 10%, 48 to 66 Hz*, 10 VA max.

Accessories furnished: comb. split image focusing plate reduction ratio scale, 2.3 m (7.5 ft) power cord, and instruction manual.

197B Options & UV Kit

	Price
001: deletes ultraviolet illumination feature	less \$50
002: replaces 197B adapter with 10378A adapter.	N/C
003: Graflok back in place of pack back	add \$225
006: replaces 197B adapter with 10375A adapter.	N/C
007: meets UL listing requirements for medical and dental electronic equipment.	add \$15
910: additional manual	add \$6
10367A Camera Bezel Adapter for 182	\$90
Ultraviolet Light Kit (P/N 00197-69507) for field installation of ultraviolet illumination feature.	\$150

197B Camera **\$1350**
*Camera operates from 48 to 440 Hz, but does not meet the ac line to chassis leakage requirements of UL 544 listing above 88 Hz.

OSCILLOSCOPES

Testmobiles: Save Bench Space, Easily Moved

Models 1006A, 1007A, 1008A & 1117B

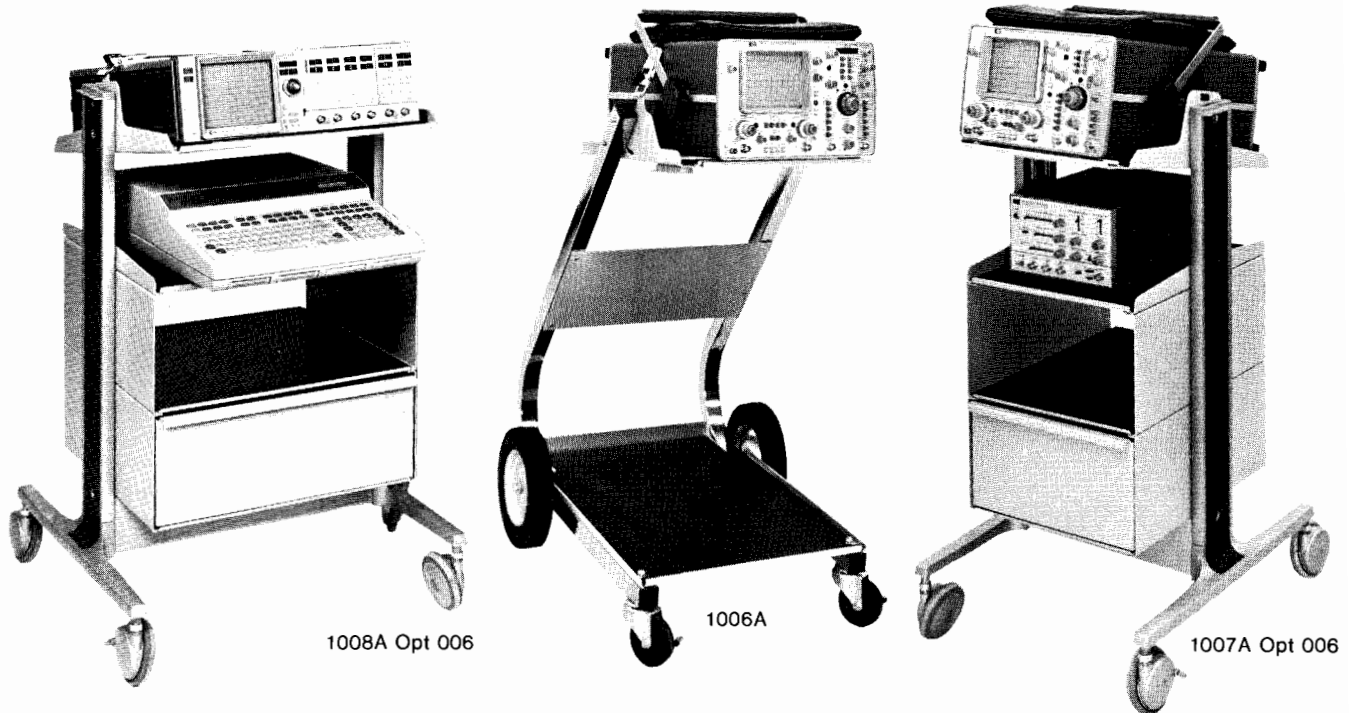

Introduction

Hewlett-Packard Testmobiles offer convenient portability for your oscilloscopes or instrumentation systems. The top tray on these testmobiles may be tilted to position your instrument for easy operation. The selection of testmobiles range from a basic model such as the 1006A, designed to hold a single oscilloscope or other instrument, to a testmobile such as the 1008A or 1117B that can be adapted to provide a complete mobile test system. Refer to the testmobile/instrument compatibility chart for assistance in selecting the testmobile that will best fit your requirements.

Testmobile/Instrument Compatibility

Testmobile Model Number	Instrument
1006A 1007A	All Hewlett-Packard 180, 1200, 1220, and 1700 Series cabinet style oscilloscopes, or other instruments that meet the height and weight requirements.
	Hewlett-Packard instruments that are configured to be mounted in a standard 48.3 cm (19 in.) rack and meet the testmobile height and weight requirements.
1117B	All instruments listed above.

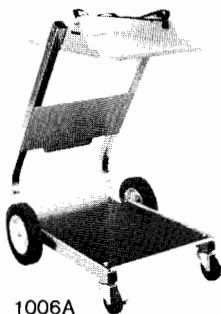

1006A

1006A Description

This is a sturdy general purpose testmobile for cabinet style oscilloscopes and other instruments (see compatibility chart). The tilt tray adjusts $\pm 30^\circ$ in 10° increments. A base tray and an accessory rack add space for other instruments and accessories; and a convenient bracket holds three HP probes. Large rear wheels allow easy movement and locking front casters hold the testmobile in position. A five outlet power strip accessory is available for mounting under the tilt tray or beneath the accessory rack.

1007A, 1008A Description

These versatile testmobiles provide a sturdy, lightweight, stable platform for your oscilloscope or instrumentation system (see compatibility chart). Large angled wheels with a wide track move quietly and smoothly over most surfaces. The top trays are table-top height and can be tilted to a convenient viewing angle between 30° above and 30° below the horizontal position with a total of seven detent positions in 10° increments. The caps on each side rail are designed to conveniently hold three probes to reduce the possibility of damaging probes not in use.

1007A, 1008A Options

Many options are available so that the 1007A or 1008A can be easily tailored to your specific requirements. Refer to the option photographs with description to select the testmobile best suited to your requirements. Options apply to either the 1007A or 1008A. Option 008, U.S. only five outlet power strip option, is also available for convenient instrument operation.

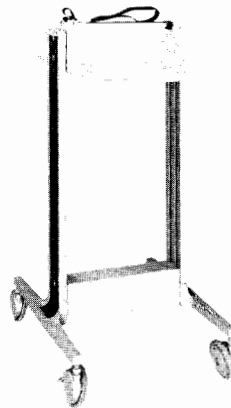

Basic Testmobile

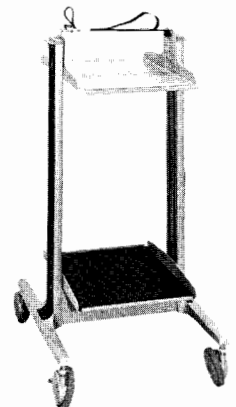
Opt 001: storage shelf
load limit: 18 kg (40 lb).

Testmobiles: Save Bench Space, Easily Moved

Models 1006A, 1007A, 1008A & 1117B (cont.)

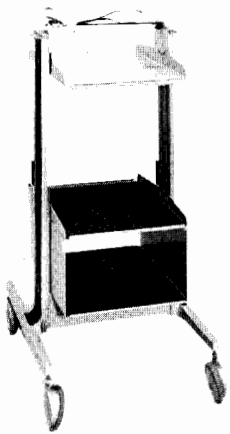

Opt 002: storage shelf and lower cabinet; load limit 18 kg (40 lb) ea.

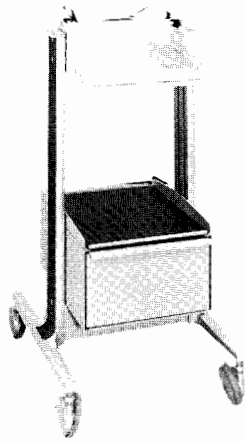

Opt 003: 15 cm (6 in.) lockable drawer with shelf on top; load limit 11 kg (25 lb) in drawer and 18 kg (40 lb) on shelf.

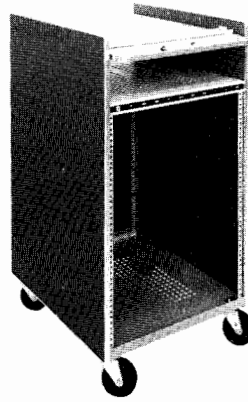

1117B

1117B Description

Model 1117B provides a mobile test station for cabinet and rack model instruments, with tilt tray angles from -15° to $+30^{\circ}$ in $7\frac{1}{2}^{\circ}$ increments for easy viewing. In addition, other instruments can be mounted in the standard EIA racks of the lower compartment. Rack mounting height is 62.2 cm (24½ in.), depth is 58.4 cm (23 in.), and power distribution is provided with a built-in four outlet power strip. Optional accessory drawers 7.6 cm (3 in.) and 20.3 cm (8 in.) deep are available to provide convenient storage space. The drawers may be installed in many vertical positions of the lower compartment, allowing room for other rack mounted equipment.

Specifications

(see Testmobile data sheet for complete specifications)

	1006A	1007A	1008A	1117B
Height	841mm (33¼")	930mm (36½")	930mm (36½")	1003mm (39½")
Overall width	502mm (19¾")	584mm (23")	759mm (29¾")	511mm (20½")
Width of tray	322mm (12½")	321mm (12½")	473mm (18¾")	
Tilt tray angle	$\pm 30^{\circ}$	$\pm 30^{\circ}$	$\pm 30^{\circ}$	-15° to $+30^{\circ}$
Weight	net	11.8 kg (26 lb)	11 kg (25 lb)	13 kg (28 lb)
	shipping	14.5 kg (32 lb)	19 kg (41 lb)	22 kg (48 lb)
Max load on tilt tray	23 kg (50 lb)	34 kg (75 lb)	45 kg (100 lb)	45 kg (100 lb)
Max load below tilt tray	23 kg (50 lb)	see Option descriptions	see Option descriptions	56.7 kg (125 lb)

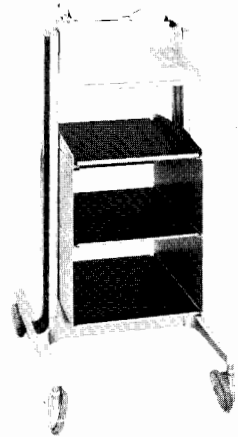

Opt 004: two storage cabinets with shelf on top; combined load limit, cabinets and shelf, 45 kg (100 lb).

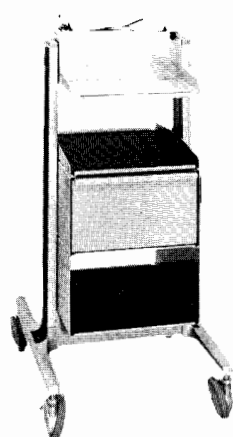

Opt 005: storage cabinet and drawer in upper position with shelf on top; load limit 18 kg (40 lb) ea on shelf and in cabinet, 11 kg (25 lb) in drawer.

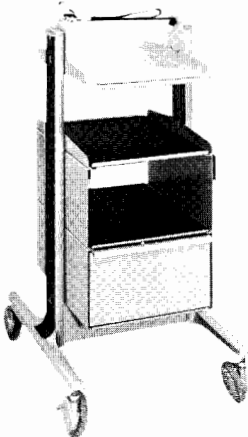

Opt 006: storage cabinet with shelf on top and drawer in lower position; load limit 18 (40 lb) ea on shelf and in cabinet, 11 kg (25 lb) in drawer.

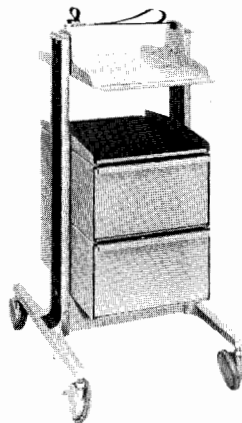

Opt 007: two lockable drawers with shelf on top; load limit 18 kg (40 lb) on shelf, 11 kg (25 lb) ea drawer.

Optional Accessories

Price

10475A 7.6 cm (3") drawer for 1117B testmobile Weight: net, 4.1 kg (9 lb); shipping, 5.9 kg (13 lb).	\$125
10476A: 20.3 cm (8") drawer for 1117B testmobile Weight: net, 5.4 kg (11 lb); shipping, 8.2 kg (18 lb).	\$175
01008-61201 Probe Pod Holder holds three small Logic Analyzer probe pods such as 10230 and 10248	\$36
01008-61202 Probe Pod Holder holds one small and one large Logic Analyzer probe for 1611A	\$38
01008-68701 Rack Mount Kit for 1008A, 13.3 cm (5¼") high for mounting under the tilt tray	\$108
01008-68702 Rack Mount Kit for 1008A, 19 cm (7½") high for mounting under the tilt tray	\$135
01007-60008 Power Strip kit adds Opt 008 power strip to all versions of 1006A, 1007A, 1008A testmobiles	\$75

Ordering Information

1006A Testmobile	\$250
Opt 008 Power Strip	add \$50
1007A, 1008A Testmobiles	(1007A) (1008A)
(see 1007A, 1008A Options for option descriptions)	\$450 \$550
Opt 001: storage shelf	add \$40 add \$45
Opt 002: storage shelf, lower cabinet	add \$100 add \$115
Opt 003: storage shelf, locking drawer	add \$175 add \$195
Opt 004: two storage cabinets, shelf	add \$170 add \$180
Opt 005: upper drawer, lower storage	add \$215 add \$260
Opt 006: lower drawer, upper storage	add \$215 add \$260
Opt 007: two locking drawers	add \$285 add \$345
Opt 008: power strip (5 outlet)	add \$50 add \$50

1117B Testmobile (includes power strip) \$615

CATHODE-RAY TUBE DISPLAYS

Imaging, Instrumentation & Computer Graphics Applications

1300 Series

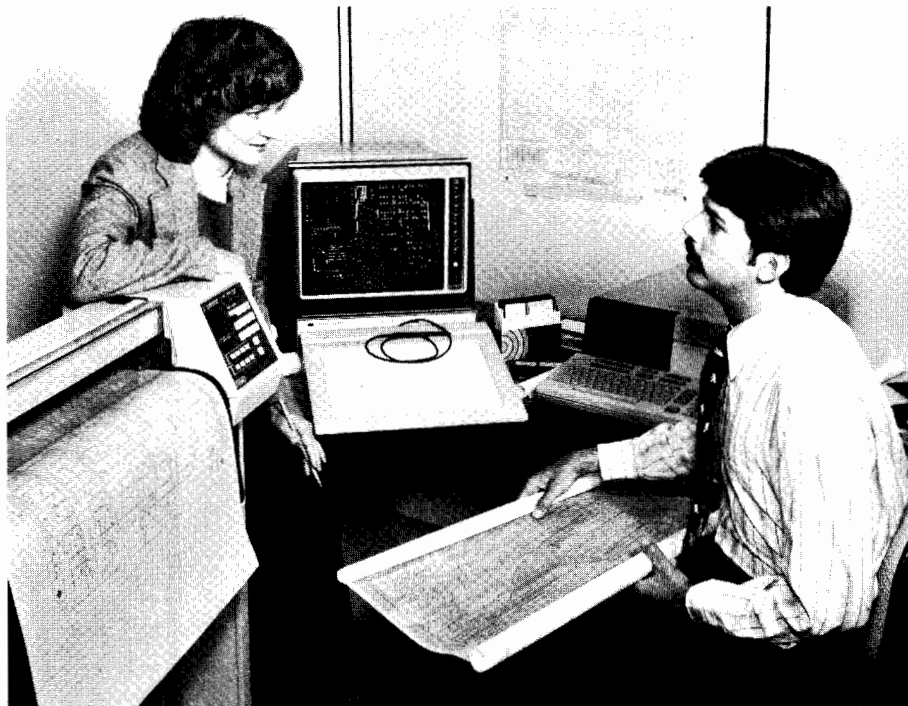

Introduction

Selecting a graphics display is no longer a simple choice between an electrostatic or an electromagnetic cathode-ray tube (CRT). The trend to microcomputer and minicomputer control of instruments and systems is generating needs to display more complex pictures. Reduced memory costs are making it possible to design a greater variety of digital displays using either electrostatic or electromagnetic CRTs.

Consequently, the choice of a display can involve both a complex set of picture needs and a separate set of requirements for interfacing the display. Picture needs include writing speed, data density, brightness, resolution, and CRT size. For example, a spectrum analyzer display needs high writing speed, has low data density, medium brightness, high resolution, and typically uses a 7 in. CRT. A terminal for a computer may require medium to high data density, low writing speed, high brightness, low resolution, and a 12 in. CRT.

Interface needs include the type of digital interface, amount of memory, data rate, local data entry provision, picture manipulation, pan control, and hard copy provisions. The designer of a measurement instrument may satisfy all of his interface requirements either within his instrument or through the front panel. The display would only have to satisfy the picture needs. Conversely, the graphic display or terminal for a computer controlled measurement system would have to meet digital interface and memory criteria as well as other needs for a keyboard, light pen, digitizer, etc.

Electrostatic CRT

The heart of HP graphics displays is an electrostatic CRT. Also included are X- and Y-axis deflection amplifiers, a Z-axis (video) amplifier, and both high and low voltage

power supplies. HP small screen displays are available with or without cabinets. In addition, several rack and bench type cabinet configurations are available, giving your designer a high degree of flexibility in incorporating HP displays into your instrument or system.

The primary attributes of the electrostatic CRT are high writing speed and low power requirements. The deflection plates are voltage driven whereas electromagnetic CRTs are current driven, through a yoke and tuned circuit in raster-scan displays. Vector writing speeds of electrostatic CRT displays are typically ten times faster than high-performance electromagnetic CRT displays.

Power requirements become a significant consideration with large screen displays. All HP large screen displays meet environmental specifications without a fan. The maximum power of any HP display is 185 watts. This can be a benefit in reducing system cooling requirements.

HP Technology

Recent advances in technology have expanded the range of applications for which electrostatic CRTs provide the optimum solution for picture drawing needs. Most of these advances have occurred in small screen (5 to 7 in. diagonal) CRTs.

- High resolution
- Increased brightness
- Beam-penetration color
- Improved light-output uniformity

The first three listed improvements in HP CRTs provide viable design alternatives to electromagnetic CRTs. The high resolution HP display offers picture drawing performance similar to an electromagnetic display, at a lower cost. Similarly, the tri-color beam penetration display has a significant price advantage over comparable electromagnetic

displays. It provides faster writing speed as an added benefit.

Increased brightness is a very significant breakthrough in electrostatic CRTs. It virtually eliminates the primary argument for using electromagnetic CRTs instead of electrostatic. With comparable brightness, the instrument designer is free to focus on other picture and access criteria.

HP electrostatic CRT displays offer several benefits in applications where raster scan picture drawing is required. In real time medical ultrasound systems the scan rate may be varied to match transducer determined scanning frequencies. This presents no problem with an electrostatic display. Conversely, the tuned circuit of an electromagnetic display has a limited frequency range for raster operation.

In some instruments or systems it is desirable to rotate the picture 90 degrees, to change its size or aspect ratio, or to offset a series of reduced size images for multiple image presentations. These operations are easy to perform with electrostatic CRT displays.

Good light output uniformity is an extremely important performance attribute for medical diagnostic applications. For a given Z-axis drive voltage, the intensity of the dot or picture element should be the same anywhere in the viewing area. HP Models 1333A, 1336S, 1345A, 1310B, 1311B, and 1321B represent a significant improvement in light output uniformity over previous displays.

Digital Interfaces

Model 1351A Graphics Generator provides a convenient digital interface between computers and controllers and the analog inputs in the majority of HP graphic displays. Model 1351A converts digital inputs to analog outputs capable of driving HP's large screen displays. The very high resolution of

these displays, combined with the 1351A's 8k vector/character generating capability, provide the complex drawing capability needed in computer aided graphics systems such as CAD/CAM.

The 1351A receives digital information from the Hewlett-Packard Interface Bus (HP-IB) or an optional RS-232-C or 16-bit parallel interface bus for storage in its internal memory. Vectors and/or characters are generated and the display is continually refreshed by the graphics generator, which frees the host computer to collect or process other data. The generator can address and display 1020 x 1020 points on a graphics display with alphanumeric listing and vector presentations.

The 64 memory files are selectable in size, separately addressable and erasable and are capable of flashing selected information on and off. Variable vector drawing speeds provide three intensity levels for highlighting selected information. This allows different levels of brightness for grids, enhancement of 3-D drawings, addition of perspective, or to improve visual clarity and speed the comprehension of displayed information.

Model 1345A is a high performance display that has a built-in digital interface and it is ideal for microprocessor-based instrumentation and system applications. The 1345A represents a new concept in instrumentation displays with its 16-bit TTL I/O. The advantage of the 16-bit I/O is that digital interfacing to a microprocessor based system provides a convenient, high performance interface. With the many peripheral interfacing adapters (PIAs) that are available, interfacing a digital system to the 1345A can be accomplished in a fraction of the time required for interfacing displays with analog inputs. The 16-bit I/O also operates with 8- or 16-bit microprocessors which assures compatibility with present and future instrument systems.

This Model 1345A digital display has 2048 x 2048 point addressability to provide high resolution graphics with excellent positional discrimination of its crisp, well focused electron beam. Picture quality and flexibility is further enhanced by its programmable intensity, speed, line type, programmable graph mode, and internal character generation. Also, there is an optional vector memory that functions as an auxiliary read/write memory. This memory provides internal display refreshing and frees the system processor for other tasks.

Information Displays

The types of pictures produced for information displays fall in two major categories: continuous-tone imaging, and line drawing. Continuous-tone imaging is best exemplified by television pictures. Line drawings may be bar charts, instrument displays, or pictures from computer-aided drafting or design systems.

Imaging Applications

HP CRT displays have been used to present continuous-tone images both for direct viewing and photographic recording for many years. One of the first applications was

to produce high-speed, random dot images from gamma cameras used in nuclear medicine. HP's advanced technology makes it possible to manufacture CRTs with highly uniform light output which is essential in assuring the diagnostic accuracy of gamma camera pictures.

Many imaging pictures are produced in a raster scan format, for which electromagnetic CRTs might be assumed to be the logical choice. An example are those produced by medical ultrasound diagnostic systems. However, the performance of real-time imaging systems can be enhanced by electrostatic CRT displays. One primary benefit is that the display can be operated at variable raster frequencies as dictated by system parameters. Displays using electromagnetic CRTs which are driven through a tuned-circuit and deflection yoke are limited to a narrow range of raster scan rates.

Model 1332A, 1333A, 1335A and 1336S displays are widely used in imaging systems. More detailed information is provided on the following pages to help you decide which display is best suited to your imaging system.



Continuous-tone image of a human fetus produced by a real-time medical ultrasound diagnostic system using an HP 1332A display. (Photo courtesy of Advanced Diagnostic Research, Inc.)

Measurement Instruments

Most measurement instruments that produce line drawing pictures operate in real-time. Because of the need for high writing speed they usually include an electrostatic CRT display. The HP Model 1340A and 1345A meet the needs of measurement instrument designers. The modular package makes them physically easy to incorporate into an instrument or system. Integrated circuit amplifiers provide flexibility when electrically integrating the 1340A with an instrument. DC voltage levels control X and Y amplifier gain and position as well as intensity. Either controls supplied with the 1340A or circuits in your instrument can be used to control the display. Model 1345A has a digital interface which makes it ideally suited to integrate into digitally controlled systems. CRT performance meets the picture drawing needs of both analog and digitally controlled instruments.

Computer Graphics

Large screen displays are used in measurement systems where the operator is more

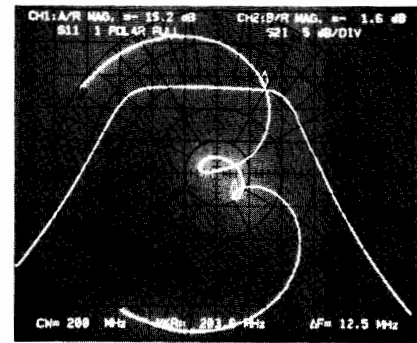

Both polar impedance and amplitude response of a filter are plotted on a network analyzer. Models 1332A, 1335A, 1340A, and 1345A can be used in many types of measurement instruments.

than an "arm's-length" from the picture. Again, the benefits of HP displays—picture writing speed and quality—are essential in real-time measurement systems.

The capability of the 1351S to update a portion of the picture without redrawing the entire display is extremely useful in measurement systems.

Radar and sonar system designers can benefit from the speed and versatility of HP graphics display systems. Most of these systems display continually changing pictures which the operator uses to make tactical decisions. He cannot afford to wait a significant length of time for pictures to be updated; the 1351A can draw complex pictures in less than 80 milliseconds. Again, selective update of the picture is valuable in reducing the time required to service the display system. For radar and sonar systems HP digital display systems represent an excellent price-performance comparison with high resolution electromagnetic CRT display systems.

Analytical chemistry systems need large screen, high resolution pictures to display various spectra. The 1351S 1020 x 1020 addressable resolution is a good match to most analytical instrument specifications. Its memory versatility enables the system operator to store several spectra and quickly display various sequences of data for comparative analysis. All this can be done at ambient light levels because of the brightness of the 1351S Display System.

Some medical research and data acquisition system applications require simultaneous display of several traces. It is possible to continuously update 1351S displays (1311B, 1310B, 1317A, and 1321B) to simulate a multiple-trace chart recorder. In this application, the high data transfer rate from the minicomputer to the 1351S Display System is a benefit.

Simulation systems usually operate in a real-time mode and require fast picture writing speeds. The 1351S is being used in several simulation systems because it can display changes in the picture at rates faster than operator response times. Other benefits for simulation systems are the capability to operate multiple displays and to use a variety of CRT sizes.

CATHODE-RAY TUBE DISPLAYS

Performance Specifications

1300 Series

CATHODE-RAY TUBE	1332A	1333A	1335A		1336S	1340A
			Conventional	Storage		
Viewing Area	≈9.6 x 11.9 cm (3.8 x 4.7 in.)	≈8 x 10 cm (3.1 x 3.9 in.)	≈7.1 x 9 cm (2.8 x 3.6 in.)		≈8 x 10 cm (3.2 x 3.9 in.)	≈9.6 x 11.9 cm (3.8 x 4.7 in.)
Quality Area	≈8.4 x 10.8 cm (3.3 x 4.3 in.)	≈8 x 10 cm (3.1 x 3.9 in.)	≈7.1 x 8.9 cm (2.8 x 3.5 in.)		≈6.4 x 8 cm (2.5 x 3.2 in.)	≈9.6 x 11.9 cm (3.8 x 4.7 in.)
Graticule	8 x 10 div 1 div = 1.2 cm	Opt, 8 x 10 div 1 div = 1 cm	8 x 10 div 1 div = 0.89 cm		None	8 x 10 div 1 div = 1.2 cm
Spot Size (within quality area)	≤0.30 mm	≤0.20 mm	≤0.25 mm	See "Resolution"	See "Resolution"	≤0.46 mm
Resolution	31.5 lines/cm (80 lines/in.)	49 lines/cm (124 lines/in.)	39 lines/cm (99 lines/in.)	20 lines/cm (51 lines/in.)	140 lines/cm (356 lines/in.) (center screen); 80 lines/cm (203 lines/in.) (quality area)	≈22 lines/cm (55 lines/in.)
Light Output (at 0.25 cm/μs, 60 Hz refresh, unless otherwise noted)	170 cd/m ² (50 fl)	34 cd/m ² (10 fl)	68 cd/m ² (20 fl)	680 cd/m ² (200 fl)	2 μW/cm ² steradian (4 x 4 cm raster)	Not Specified
Light Output Uniformity	Not Specified	≤16% overall ≤6%/cm	Not Specified	Not Specified	≤16% overall ≤6%/cm	Not Specified
Light Output Stability	<10%/hr	<10%/hr	<10%/hr	Not Specified	<5%/hr	Not Specified
Writing Speed (Storage)	N/A	N/A	N/A	≥50 cm/ms	N/A	N/A
Dot Writing Time (Storage)	N/A	N/A	N/A	≤1 μs	N/A	N/A
Storage Time	N/A	N/A	N/A	<1 minute (Write Mode)	N/A	N/A
X & Y AXES AMPLIFIERS						
	1332A	1333A	1335A		1336S	1340A
Deflection Factor Range	80–200 mV/div	80–200 mV/cm	80–200 mV/div		100–200 mV/cm 0.5–2.0 V/cm	80–200 mV/div, 0.4–1.0 V/div
Settling Time	≤300 ns	≤300 ns	≤300 ns		≤500 ns	≤300 ns
Linearity	≤3%	≤3%	≤3%		≤3%	≤5%
Dynamic Range	Up to ½ screen diameter off screen in any direction.					
Drift	≤1 mm in 24 hours.					
Z-AXIS AMPLIFIER						
	1332A	1333A	1335A		1336S	1340A
Blanking Range (Internal Adjust.)	1 V–2.5 V p-p	1 V–2.5 V p-p	1 V–2.5 V p-p		1 V–2.5 V p-p, 5 V–25 V p-p	1 V–2 V p-p
Rise Time	≤25 ns	≤25 ns	≤25 ns		≤25 ns	≤25 ns
X, Y, Z INPUTS	Single-ended BNC	Single-ended BNC	Single-ended BNC		Differential, Separate BNC's	Single-ended BNC
Input RC	≈1 MΩ, ≤60 pF (50 Ω Optional)	≈1 MΩ, ≤60 pF (50 Ω Optional)	≈1 MΩ, ≤60 pF (50 Ω Optional)		≥10 kΩ, <70 pF (50 Ω selectable)	≥1 MΩ, <40 pF (50 Ω selectable)
Maximum Input	±50 V	±50 V	±50 V		±50 V	±50 V
Line Power at 60 Hz, 120 VRMS	≈24 W	≈40 W	≈35 W		≈100 W	≈30 W
UL Medical & Dental Listing	Optional	Optional	Optional		Standard	Optional
UL Medical & Dental Component Recog.	Standard	Standard	Standard		N/A	Optional

Note: These are condensed specifications; refer to applicable data sheet for complete specifications, including options and accessories.

Common Specifications

Operating Environment

Temperature: 0°C to +55°C (+32°F to +131°F), operating; –40°C to +70°C (–40°F to +158°F), non-operating.

Humidity: to 95% RH at +40°C (+104°F).

Altitude: to 4600 m (15 000 ft), operating; to 6300 m (20 669 ft), non-operating.

Shock: 30 g peak, ½ sine wave, 11 ms duration.

Vibration: 15 min. in each plane at 0.38 (0.015 in.) mm p-p excursion, 5–55 Hz, 1 min./octave, 10 min. at each resonant frequency

(except 1332A, 1333A, 1335A: 15 min. in each plane, 0.25 mm (0.010 in.) p-p excursion, 10–55 Hz).

Primary line voltage: 100, 120, 220, or 240 Vac, +5%, –10% (1333A, 1336S: +5%, –20%).

Ordering Information

1332A Small Screen Display

1333A Small Screen Display

1335A Small Screen Display

1336A Display Module

1336P Power Supply Module

1336S Display System (includes 1336A, 1336P)

1340A Display Module (with control panel)

OEM and quantity discounts available.

Price

\$2050

\$2300

\$2750

\$2950

\$950

\$3900

\$1350



CATHODE-RAY TUBE	1338A (Color)	1304A*	1310B	1311B	1317A	1321B
Viewing Area	≈9.6 x 11.9 cm (3.8 x 4.7 in.)	≈20 x 25 cm (7.9 x 9.8 in.)	≈28 x 38 cm (11 x 15 in.)	≈20.3 x 25.4 cm (8 x 10 in.)	≈26 x 34 cm (10.2 x 13.5 in.)	≈30.5 x 35 cm (12 x 14 in.)
Quality Area	≈8 x 10 cm (3.2 x 3.9)	≈20 x 25 cm (7.9 x 9.8 in.)	≈28 x 38 cm (11 x 15 in.)	≈20.3 x 25.4 cm (8 x 10 in.)	≈25.4 x 25.4 cm (10 x 10 in.)	≈30.5 x 30.5 cm (12 x 12 in.)
Spot Size (center screen) (corners)	≤0.36 mm (0.014 in.)	≥0.5 mm (0.02 in.)	≤0.51 mm (0.02 in.) ≤0.76 (0.03 in.)	≤0.43 mm (0.017 in.) ≤0.51 (0.02 in.)	≤0.51 mm (0.02 in.)	≤0.51 mm (0.02 in.)
Resolution	28 lines/cm (70 lines/in.)	20 lines/cm (50 lines/in.)	19.7 lines/cm (50 lines/in.)	24 lines/cm (61 lines/in.)	19.7 lines/cm (50 lines/in.)	19.7 lines/cm (50 lines/in.)
Light Output (at 0.25 cm/μs, 60 Hz refresh)	Color Dependent	19.2 cd/m ² (5.6 fl)	84 cd/m ² (24.5 fl)	84 cd/m ² (24.5 fl)	82.4 cd/m ² (24 fl)	82.4 cd/m ² (24 fl)

X & Y-AXES AMPLIFIERS	1338A	1304A	1310B	1311B	1317A	1321B
Deflection Factor Range (approx.)	Internally Adjustable, ≈0.9 V to 2.5 V for full deflection	80-120 mV/div, 1 div = 20 mm (0.8 in.)	(Vertical) 35, 80-60.9 mV/cm, 90-153 mV/in. (Horizontal) 26.2-45.9 mV/cm, 67-117 mV/in.	(Vertical) 46.3-81 mV/cm, 118-207 mV/in. (Horizontal) 35.8-60.9 mV/cm, 90-153 mV/in.	39-69 mV/cm, 100-175 mV/in.	33-58 mV/cm, 83-147 mV/in.
Settling Time	≤300 ns	≤300 ns	≤500 ns	≤500 ns	≤1 μs	≤500 ns
Repeatability error	Not Specified	<0.15%	<0.15%	<0.15%	<0.15%	<0.15%
Linearity	≤2%	≤3%	≤1%	≤1%	≤3%	≤1%
Dynamic Range	Up to ½ screen diameter offscreen in any direction					
Drift	≤2.5 mm in 24 hours		8.9 mm in 24 hrs	6.3 mm in 24 hrs	8.9 mm in 24 hrs	10.2 mm in 24 hrs

Z-AXIS AMPLIFIER	1338A	1304A	1310B	1311B	1317A	1321B
Blanking Range	Internally adjustable from 1 V to 2.5 V p-p.					
Rise Time	≤30 ns	≤25 ns	≤25 ns	≤25 ns	≤20 ns	≤20 ns
X, Y, Z INPUTS	Differential, separate BNC's	Differential, separate BNC's	Single-ended BNC	Single-ended BNC	Single-ended BNC	Single-ended BNC
Input RC	≈100 Ω, ≈70 pF or 50 Ω	≥100 kΩ, ≤65 pF (50 Ω selectable)	(X, Y inputs) 50Ω or ≈10 kΩ/ ≈40 pF (Z input) 50Ω or ≈10 kΩ/ ≈60 pF	(X, Y inputs) 50Ω or ≈10 kΩ/ ≈40 pF (Z input) 50Ω or ≈10 kΩ/ ≈60 pF	(X, Y inputs) 50Ω or ≈10 kΩ/ ≈40 pF (Z input) 50Ω or ≈10 kΩ/ ≈60 pF	(X, Y inputs) 50Ω or ≈10 kΩ/ ≈40 pF (Z input) 50Ω or ≈10 kΩ/ ≈60 pF
Maximum Input	(High Z) ±50 V (50 Ω) ±2.5 V	(High Z) ±50 V (50 Ω) ±2.5 V	(High Z) ±50 V (50 Ω) ±5 V	(High Z) ±50 V (50 Ω) ±5 V	(High Z) ±50 V (50 Ω) ±5 V	(High Z) ±50 V (50 Ω) ±5 V
TTL Blanking Input (rear panel BNC)	Standard	Optional	Standard	Standard	Standard	Standard
Primary Line Voltage	100, 120, 220, or 240 Vac +5%, -10%	100, 120, 220 or 240 Vac +5%, -20%	100, 120, 220 or 240 Vac +5%, -20%	100, 120, 220 or 240 Vac +5%, -20%	100, 120, 220 or 240 Vac +5%, -10%	100, 120, 220 or 240 Vac +5%, -10%
Maximum Power	≈100 W	≈85 W	≈185 W	≈185 W	≈100 W	≈110 W
UL Medical and Dental Listing	Not Available	Optional	Optional	Optional	Optional	Optional

Note: These are condensed specifications; refer to applicable data sheet for complete specifications, including options and accessories.

Common Specifications

Operating environment

Temperature: 0°C to 55°C (+32°F to +131°F), operating; -40°C to +70°C (-40°F to +158°F), non-operating.

Humidity: to 95% RH at +40°C (+104°F).

Altitude: to 4600 m (15 000 ft), operating; to 7600 m (25 000 ft), non-operating (15 300 m, 50 197 ft for 1304A).

Vibration: 15 min. in each plane, 0.25 mm (0.010 in.) p-p excursions (0.38 mm, 0.015 in. for 1304A, 1338A), 5 to 55 Hz; 1 min./octave, 10 min. at each resonant frequency.

Ordering Information

***1304A** 32 cm (14 in.) Display

1310B 48 cm (19 in.) Display

1311B 36 cm (14 in.) Display

1317A 43 cm (17 in.) Display

1321B 53 cm (21 in.) Display

1338A Tri-color Display

Price

\$3025

\$6300

\$5700

\$5300

\$6600

\$4750

*Not recommended for high speed, high resolution computer graphics applications.



CATHODE-RAY TUBE DISPLAYS

Digital Display Specifications

Models 1345A, 1351A

GENERAL	1345A	1351A
Input Power	+15 Vdc \pm 5% Regulated; \leq 1.05A, \leq 10 mV p-p ripple. -15 Vdc \pm 5% Regulated; \leq 0.3A, \leq 10 mV p-p ripple. +5 Vdc \pm 5% Regulated; \leq 0.75A, \leq 50 mV p-p ripple.	Selectable 100, 120, 220, or 240 Vac, +5%, -10%, 48 Hz -440 Hz, max power 120 VA (X95W). Average power dissipation at 60 Hz, 120 V \approx 90 W w/o options.
PROGRAMMING INPUT	1345A	1351A
Interface(s)	16-bit TTL	HP-IB 16-bit binary (option 002) RS-232C (option 001) Rear Panel, conforms to IEEE 488-1978 (HP-IB only).
CHARACTER GENERATOR	1345A	1351A
Character Set Character Sizes Character Orientation	Full ASCII 4 Programmable 4 Programmable	Modified full ASCII 4 Programmable 2 Programmable
VECTOR GENERATOR	1345A	1351A
Resolution Intensities Line Types Writing Speeds	0-2048 X, 0-2048 Y 3 Programmable 4 Programmable 4 Programmable	0-1020 X, 0-1020 Y 3 Programmable 3 Programmable
ANALOG OUTPUTS	1345A	1351A
Levels	X, Y, Z; 0-1 Vdc, into 600 Ω , 0-5 MHz bandwidth	X, Y, Z; 0.2 V-1.2 V into 50 Ω (X and Y). -1V to 1V into 50 Ω (Z). Logic Control (Intensity) TTL into 50 Ω . Rear Panel BNCs for X, Y, Z axes. Auxiliary intensity control connector.
CONNECTORS		
DATA ACCEPTANCE	1345A	1351A
	\approx 10k-667k words/sec (dependent on 1345A, user processor)	\approx 6.25 words/sec (RS-232C @ 50 baud)-500k words/sec (16 bit I/O).
CATHODE RAY TUBE	1345A	1351A
Type Phosphor Screen Size Viewing area Brightness	Electrostatic P31 16cm diag. 119° cm; 9.6 cm vert. x 12.5 cm horiz. 3170Cd/m @ 2.54 mm/ s writing rage, full brightness, 60 Hz refresh rate.	N/A

Note: These are condensed specifications; refer to applicable data sheet for complete specifications, including options and accessories.

COMMON SPECIFICATIONS

Operating environment

Temperature: 0°C to +55°C (65°C for 1345A) operating; -40°C to +70°C non operating.

Humidity: to 95% relative humidity at +40°C (50°C for 1345).

Altitude: to 4600 m operating; 7600 m (15 300 m for 1345A) non operating.

Ordering Information

1345A Digital Display \$3350
1351A Graphics Generator \$5000

CATHODE-RAY TUBE DISPLAYS

Instrumentation Display Modules

Model 1340A

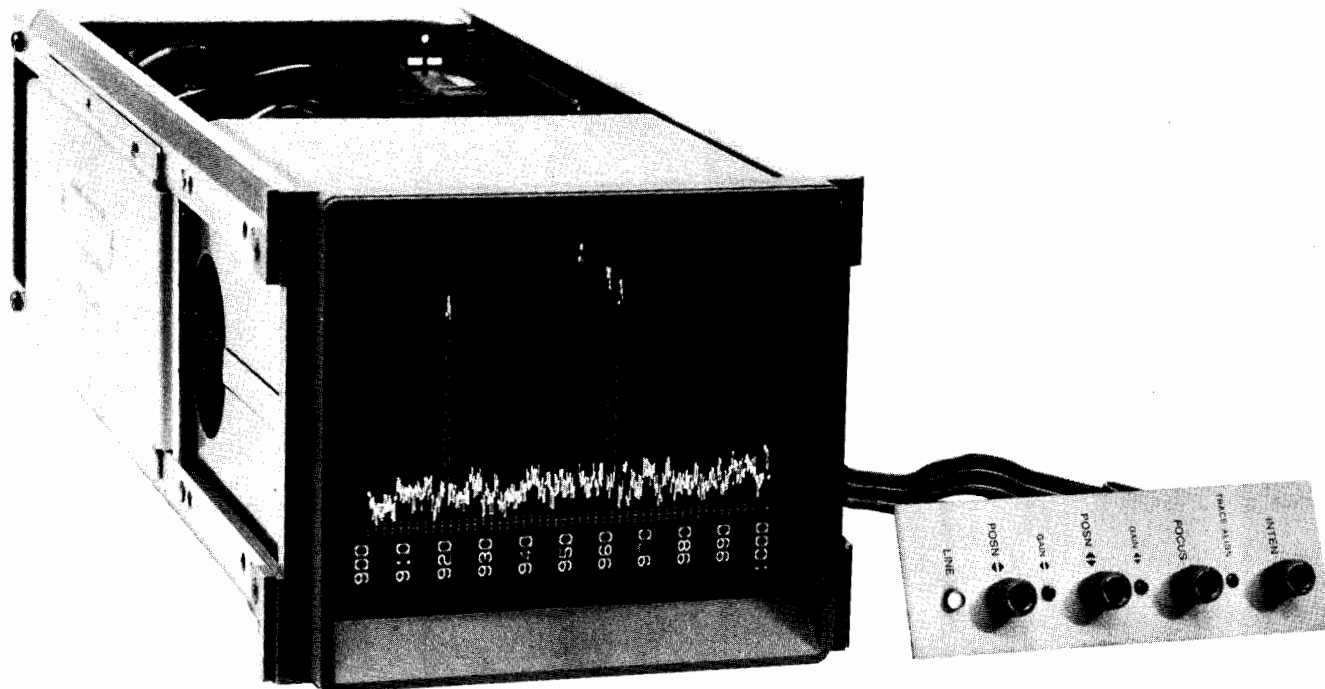

1340A Option 631

1340 Description

Model 1340A modular 15.3 cm display offers flexibility, convenience, and cost-effectiveness for OEM system designers with a basic display module that is rugged and easy to integrate into an instrument or system console.

Functional controls for intensity, focus, X and Y position, X and Y gain, and trace alignment can be located to suit design criteria. The standard display module includes a control panel that can be located to the right of the module or in a remote position. An option is available which omits the control panel so that you can use your own controls. Since the control functions are dc inputs to the integrated-circuit amplifiers, you can provide them from an appropriate part of your system.

Electronics

Integrated circuits contain most of the X, Y and Z amplifier components, improving reliability as well as reducing cost. X and Y attenuators, input impedance, polarity, and bandwidth limiting are internally switch selectable. This provides flexibility to designers and inventory convenience when you use the 1340A in more than one instrument or system.

A dc supply option deletes the power transformer, rectifiers, and power line cable, allowing power to be supplied from your own instrument or system. Two voltages are required: regulated +20 Vdc and regulated -15 Vdc.

Mechanical Construction

The 1340A module is a unitized structure, which is independently rugged without a cabinet. The display integrates easily into almost any instrument or system console design. If you wish to simplify the cabinet design for your system, there are several OEM cabinets for the 1340A. These are attractively styled and accommodate circuitry for a variety of instrument applications.

Serviceability

Ease of service is designed into the 1340A, beginning with the mechanical construction which provides easy accessibility and continuing with an electrical design that incorporates IC's which reduce the number of components that can fail.

The power supply and amplifier boards are easily removed, giving you several service options: remove the entire module for service off-site, substitute pc boards and repair removed boards at a central location, or on-site component level repair. Your HP Field Engineer can arrange a service support plan to meet your needs.

Applications

The price-performance ratio of the 1340A makes it ideal for almost every instrumentation system. Resolution, viewing area, and brightness are suitable for spectrum, network, vibration, transient, pulse height, and digital logic analyzers. The CRT writes a clear, crisp trace.

The 1340A can be used in a number of non-destructive test systems or instruments. The dc gain adjustment is helpful in remotely programming changes of the parameters being displayed. This capability is particularly useful in programmed test systems where operator interaction is impossible or undesirable.

The 1340A is adaptable to geophysical measurement systems, particularly the dc power option. This option simplifies integration into a system and reduces weight, a benefit with portable equipment or other systems that require minimum size and weight.

The 1340A may also be used as a basic display for communication system analyzers, chemical and scientific analysis systems, and some medical diagnostic systems. And it provides an economical operator interface in special production test systems. With the optional full rack module cabinets you have space to mount your own test system circuitry.

Ordering Information

For a complete listing of options, refer to the 1340A data sheet.

	Price
1340A Display Module (with control panel)	\$1350
Opt 001: display module without control panel	less \$25
Opt 002: display module and control panel without internal power supply (requires +20 Vdc regulated $\pm 5\%$ including ripple, 1.5 A; and -15 Vdc regulated $\pm 5\%$ including ripple, 0.25 A; each supply floating with its own ground return.)	less \$25

CATHODE-RAY TUBE DISPLAYS

Instrumentation Display Modules

Models 1304A & 1340A

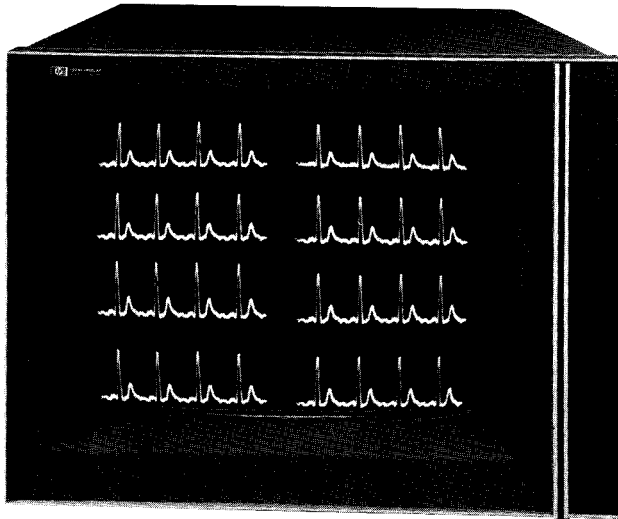

1304A

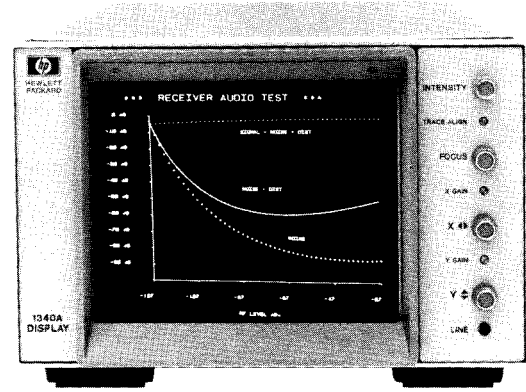

1340A Option 315 includes half rack width cabinet

Models 1304A and 1340A provide the electrical performance and picture quality required for most measurement instruments. In addition, the cabinet designs provide convenience in the mechanical integration of the displays into a variety of instrument or system configurations. Both units are well suited for engineers or scientists who need good display performance at a reasonable cost.

1304A Description

The 1304A is a moderately-priced, large screen display that has high writing speed and fast settling time. Both X and Y amplifiers have full differential input. In addition, there are internal switches that enable the user to select one, five, or ten volt full scale input at either 50 Ω or 100 Ω impedance. This makes the 1304A well suited for general purpose use or as a component in production test systems.

A wide variety of measurement systems and analytical instruments often require an auxiliary display. The 1304A provides an excellent price-performance ratio in these applications. If optimum picture resolution is desired, the Model 1311B with the same 14-inch CRT size as the 1304A is recommended.

High writing speed means that the 1304A can be used in system applications where electromagnetic CRT displays are too slow. An example of this is multiple-bed patient monitoring systems, where four to eight heart rates are shown on the CRT.

1340A Description

High writing speed and input voltage range selection are also available in the Model 1340A. A variety of cabinet configurations offer benefits to engineers and scientists who either want to add a display to an instrument or who are designing an instrument around the display. Option 315, shown above, makes the 1340A a free standing display for use with instruments such as logic analyzers, network analyzers, vibration analyzers, swept receivers, or other instrument analyzers or systems that do not have a built-in display.

Other cabinet options allow room for the instrument designer to package his circuits and power supply with the display in one unit. These are valuable whether you are building a research tool or production quantities of a product. The relatively short length (approx. 17 in.) of the 1340A appeals to designers of systems for airborne operations and other applications where space is at a premium.

1340A Accessories: Model 10380A Cabinet and Frame Kit provides an empty 13.4 cm (5.25") high half-rack module for mounting

beside the 1340A. The kit includes the half-rack module, connecting hardware for the 1340A, and full rack width top and bottom covers. Model 10386A Cabinet and Frame Kit provides the same features for mounting an empty module above or below the 1340A.

Options

For a complete listing of options, refer to the 1304A or 1340A data sheets.

Digital Input (1304A)

216: TTL blanking level. High state (+2.5 to +5 V) adds \$50

blanks any Z-axis analog input signal. Low state (0.0 V to 0.8 V) returns blanking to analog Z-axis input. Input through rear panel BNC connector.

217: same as 216, except polarity reversed adds \$50

218: 4-bit binary input allows binary selection of 16 adds \$100

levels of gray shades, TTL levels. Settling time ≤ 300 ns. Levels linear within $\pm 20\%$. Includes 25 pin program connector mounted to rear panel. When Option 218 is ordered with Option 216 or 217, TTL blanking input is provided through both a BNC connector and the 25 pin remote connector.

Cabinets (1340A)

315: Display module with HP System II 133 mm adds \$100

(5.25") high, half-rack width cabinet, 381 mm (15") long and with control panel (Model 1340A is supplied without cabinet and with control panel.)

316: Display Module with rear bracket for mounting in adds \$50

10380A (side-by-side cabinet) or 10386A (vertically stacked cabinet) with 457 mm (18") side struts. Front casting, rear casting, two 457 mm (18") struts, no covers, rear cover panel.

317: Display module with HP system II 133 mm adds \$150

(5.25") high, full-rack width cabinet with 381 mm (15") long struts, 488 mm (17.63") overall length. Painted blank front panel and rear filler panel included.

Ordering Information

1304A Large Screen Display \$3025

1340A Display Module (with control panel) \$1350

10380A Cabinet and Frame Kit (side by side) for \$200

1340A

10386A Cabinet and Frame Kit (vertically stacked) \$200

for 1340A

CATHODE-RAY TUBE DISPLAYS

Instrumentation Display Modules

Model 1345A



- 16-Bit TTL I/O
- 11-Bit Addressable Resolution (2048 by 2048)
- Random Vector Plotting
- Internal Character Generation
- Programmable Intensity, Speed and Line Type
- Modular Construction

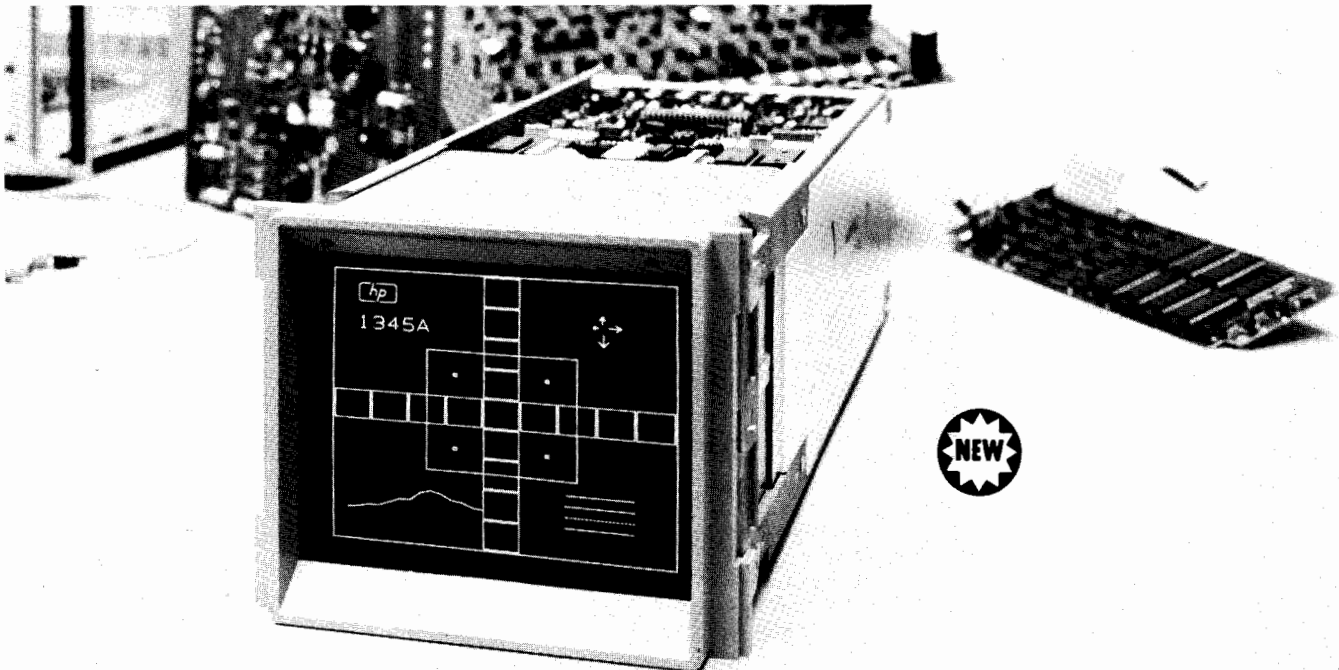

Description

Hewlett-Packard's Model 1345A is a high performance digital display for microprocessor-based instrumentation and system applications. This display module features a 16-bit digital interface for compatibility with today's digital instrumentation architectures. An electrostatic deflection CRT supplies fast writing rates with high resolution, and at low power. The 1345A's small package takes a minimum of space which makes it easier to design into an instrument or system.

The 1345A produces exceptional quality vector graphics in response to digital commands from a user processor. The 2048 x 2048 point addressability on the CRT provides high resolution graphics and allows for excellent positional discrimination of its crisp, well focused electron beam. Picture quality is further enhanced by programmable intensity, speed, line type, programmable graph mode, and internal character generation.

The Digital Display

Instruments and instrumentation systems are incorporating more and more digital control circuits and as a result require displays with a direct digital interface. Model 1345A solves this problem by combining a high performance display with a digital interface. This digital interface accepts digital information directly from a data bus and directly displays it as high quality graphics information. The binary interface in the 1345A assures flexibility and compatibility by allowing the use of 8-bit or 16-bit microprocessors.

Interfacing

The 1345A represents a new concept in instrumentation displays with its 16-bit TTL I/O. The advantage of this interfacing method is that interfacing to a microprocessor-based system is faster and easier. With the many peripheral interface adapters (PIAs) that are available, interfacing a processor to the 1345A can be accomplished in a fraction of the time required for interfacing displays having analog inputs. The 16-bit I/O allows operation with 8-bit or 16-bit micro-

processors which assures that the 1345A will be compatible with present and future instrument systems. Ease of interfacing and the resulting savings in design time makes the 1345A ideally suited for incorporation in today's digital instrumentation systems.

Operation

Model 1345A is a high performance display that generates and displays information derived from digital information received through its I/O port. It provides the fast information throughput, rapid picture manipulation, and complex vector drawing capability needed in instrumentation systems.

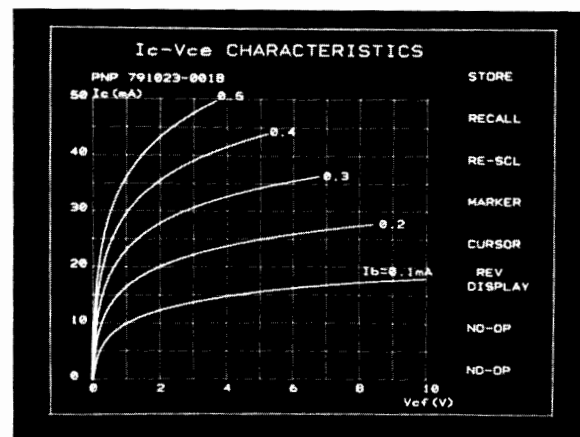

In standard configuration, the 1345A displays a picture which is defined by commands and data transmitted over the digital I/O. Vectors are drawn automatically by defining end points, at any one of the four programmable writing speeds. Vector end points can be defined anywhere on the CRT screen with 2048 by 2048 point resolution. This high resolution allows very smooth curves and precise detail to

CATHODE-RAY TUBE DISPLAYS

Instrumentation Display Modules

Model 1345A (Cont.)

be presented on the 1345A CRT. Furthermore, there are three programmable intensities, plus blanking, which are useful for maintaining a consistent picture intensity with different length vectors or can be used to highlight important information. The programmable intensity levels and writing speeds can also be combined to provide up to 12 different intensities.

A programmable delta X increment simplifies the generation of complex graphs and saves system memory space. In this mode, the X increment is stored once with only the Y values being updated and stored in memory.

Display refresh is provided by the system which gives flexibility with variations in the amount of memory used for different pictures. This method of refresh provides the ability to define the refresh cycle and eliminates flicker when there might be a conflict between a standard (or predetermined) refresh cycle and the time required to draw a picture.

A modified ASCII character set is stored in an internal ROM and the display can be programmed to supply characters in four sizes and four degrees of rotation. Since the vector data for the characters is contained in ROM, only one word of RAM is needed for each character, which makes more words of RAM available for other uses. Characters can be written in about 15 μ s which allows up to 1000 characters to be written without flicker.

An optional 4k by 16-bit vector memory can be installed that serves as an auxiliary read/write memory for the system processor. This vector memory automatically refreshes the display and frees the system processor for other functions. An addressable pointer in the memory allows portions of a picture to be quickly updated without the need for changing the entire memory. Additionally, an internal jump capability allows the system processor to suppress portions of a picture, such as gratitudes or labels, by directing the vector memory to skip past them. When desired, suppressed data can be added to a picture with only one or two commands from the system processor.

Applications

In spectrum analyzers, the 1345A's high data acceptance and vector drawing rates allow complex traces to be generated as rapidly as new data is acquired. Multiple programmable intensity levels aid in visualization by discriminating between complex overlapping traces. The high resolution of 2048 by 2048 points along with a crisp trace allows fine details to be displayed so that the measurement capabilities of high technology systems are not compromised.

In medicine, monitoring of physiological parameters requires faithful preservation of input signals for accurate diagnosis; this is assured with the display's high resolution. The speed of the 1345A allows the entire picture, even with several waveforms displayed, to be updated in real-time as rapidly as new data is acquired. The low power

requirement, light weight, and rugged construction also makes the 1345A ideal for use in portable or mobile equipment.

In airborne applications, there are extreme demands on electronic equipment in terms of volume, mass, power, and rugged construction. The 1345A meets these challenges without any compromise in speed of information updating or picture quality and brightness.

Mechanical Construction

The 1345A module is a unitized structure, which is independently rugged without a cabinet. The display integrates easily into almost any instrument or system console design. If you wish to simplify the cabinet design for your system, there are several OEM cabinets for the 1345A. These are attractively styled and accommodate circuitry for a variety of instrument applications.

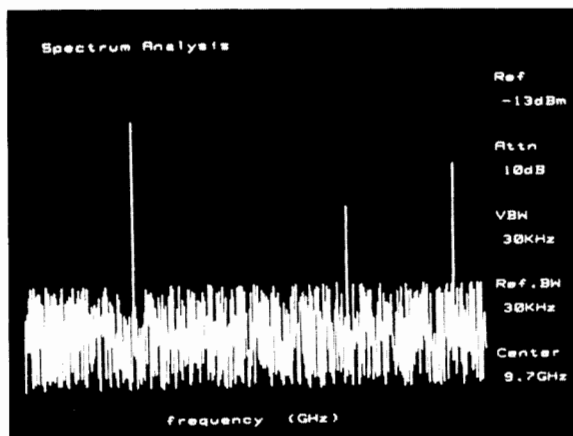
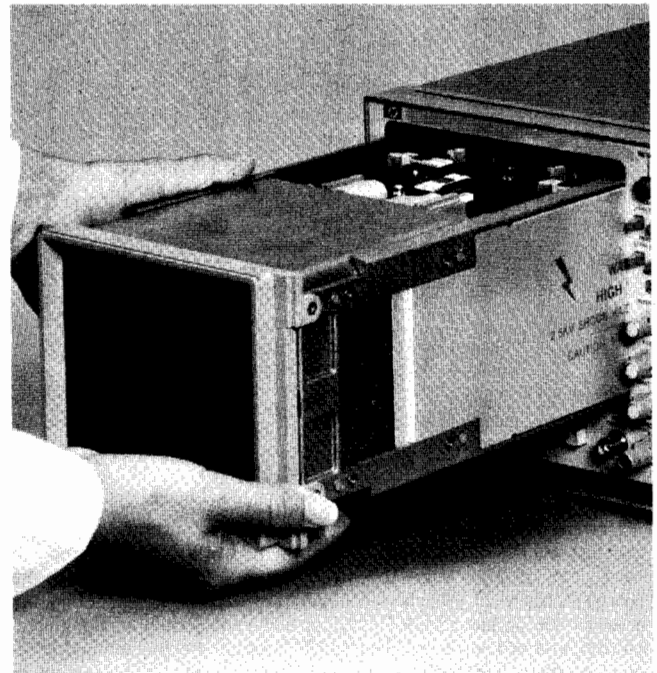

Ordering Information

(OEM and quantity discounts available; contact your local Hewlett-Packard office for additional information.)

Model 1345A Digital Display Module

Prices

\$3350

Options

323:	Output Cable Kit. 61 cm (24") X, Y and Z coaxial cable with mating connectors for 1345A on one end.	\$50
325:	Input Cable Kit. 76 cm (30") Data Cable; 91 cm (36") Power Cable; Mating connectors for 1345A on one end, stripped other end.	\$50
400:	Metric Hardware.	N/C
500:	Deletes Service Manual.	Less \$10
505:	Deletes Designers Manual.	Less \$10
564:	Blue Contrast Filter replaces Neutral Density Filter.	N/C
704:	4k Word/Vector Memory.	\$350
910:	Extra Manual.	\$10

Accessories

197B Option 006 Camera.

\$1250

- Computer/Calculator Compatible Digital Interfaces
- Fast Display Updating
- High Resolution Graphics



The 1351S Display System includes a 1311B X-Y Display, a 1351A Graphics Generator, rack mounting parts, a tilt stand which provides space below the display for the generator, an interconnecting cable, and a binder for instruction manuals.

Model 1351S Display System provides a high resolution, real-time, cost-effective solution for generating bright line vectors and/or alphanumeric characters. This system includes a high quality large screen HP electrostatic CRT display (with gain controlled Z-axis) and the 1351A Graphics Generator.

The 1351A Graphics Generator accepts digital instructions and data from a computer or calculator and stores it in digital memory. Contents of memory are then used to generate X, Y, and Z analog voltages capable of driving a display. Continuous display refreshing of up to 8000 vectors by the 1351A with 32k bytes of memory removes the load on the controller or computer.

The 1351A provides bright, high-resolution graphics in minicomputer or desk-top computer systems on either large or small screen CRT displays. The Graphics Generator can address and selectively display 1020 x 1020 points on a CRT display. This can be a mix of text and vector presentations.

The Graphics Generator has a significant advantage in system applications with its ability to drive up to four CRT displays, each with different information. Presenting different information to multiple displays is accomplished with 64 independent files.

The 64 files also provide selective erase to change some or all of the data on any display without altering the information on all the displays. For added operating flexibility, the 64 files are selectable in size, separately addressable and erasable, and can be directed to flash information to highlight areas of interest on any display.

Each digital word in the 1351A can be a vector coordinate or an upper or lower case ASCII character. A character ROM generates each ASCII character, using only one word of RAM, making more words of RAM available for other display information. Each character can be programmed to be displayed in four different sizes with two degrees of rotation (0 and 90°).

RS-232-C or 16-Bit Parallel Optional Interface

The 1351A has an extremely flexible interface structure. As a result, a specific type of interface is implemented as a simple plug-in circuit card or module. The 1351A has HP-IB as the standard interface and RS-232-C or 16-Bit parallel binary as an optional replacement.

Features of the 1351A RS-232-C option are:

- Software compatibility with most teletypewriter system handlers,
- Increased transmission distances,
- Selectable clock rates from 110 to 9600 baud, and a
- Special high speed transmission rate of 57k baud.

Features of the 16-Bit parallel interface are:

- High speed data transfer rate of 500k 16-bit bytes/sec, and a
- Vector transfer rate of up to 250k vectors/sec.

Applications

The 1351S is ideally suited for minicomputer and calculator applications which require high speed and/or high resolution displays. Typical applications are:

- Radar and Sonar
- Fire Control
- Integrated Circuit Layout
- Instrumentation Displays
- Production Testing and Calibration
- Process Control
- Flight Instrument Simulation
- Structural Design
- Computer Aided Design
- Interactive Graphics
- Analytical Chemistry Scans
- Spectrum Analysis

Options and Accessories

Options and Accessories	Price
001: RS-232-C interface instead of standard HP-IB	add \$300
002: 16-Bit parallel interface instead of std HP-IB	N/C
510: 1310B, 19 in. X-Y display instead of 1311B	add \$600
517: 1317A, 17 in X-Y display (rack mounting configuration) instead of 1311B	less \$400
521: 1321B, 21 in. X-Y display instead of 1311B	add \$900
604: P-4 phosphor display, without graticule	add \$30
639: P-39 phosphor display, without graticule	add \$30

Ordering Information*

1351S Display System (includes 1311B display)	\$10,850
1351A Graphics Translator (supplied with 1351S)	\$4250

*An HP-IB cable is not supplied and must be ordered separately (see pg. 30).



CATHODE-RAY TUBE DISPLAYS

Computer Graphics Systems

Model 9111A Option 050

- Compatible with 1351S
- Direct Display Interaction
- HP-IB Compatible
- Durable Ceramic Platen
- Menu of 16 Soft Keys
- 36 Mnemonic ASCII Commands

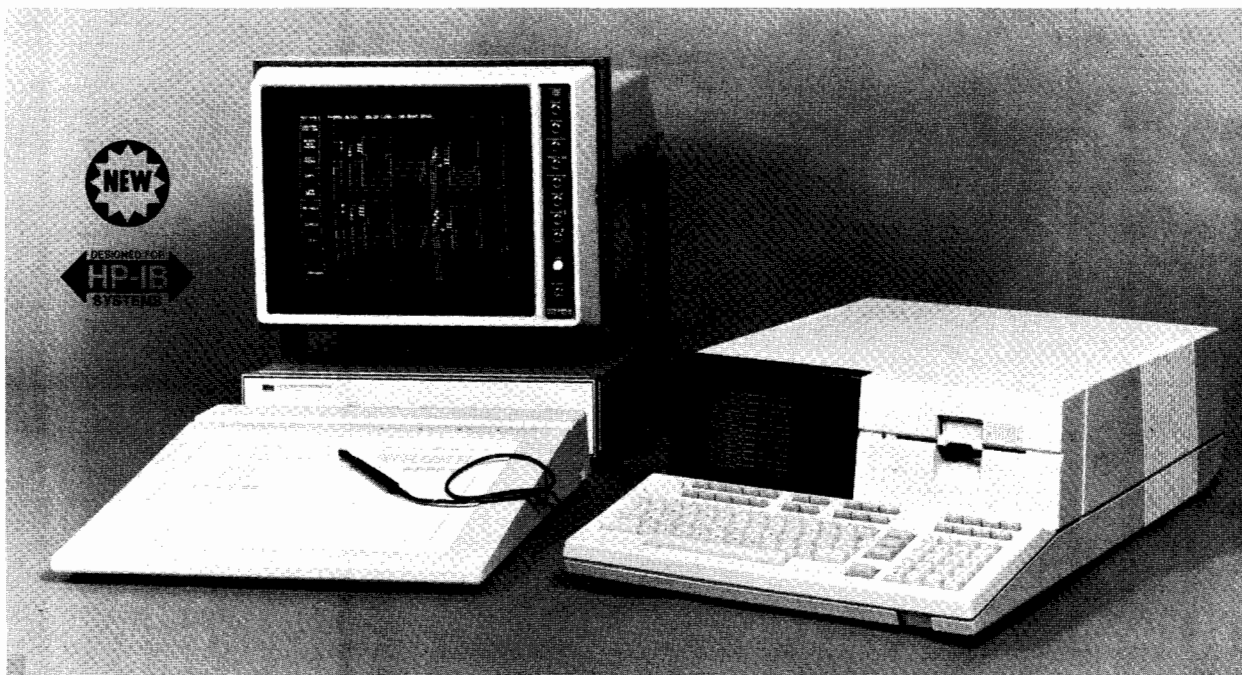

The 9111A/Option 050 is a high performance graphic input device for use with the 1351S Graphics Display System and any computer or controller with HP-IB interfacing capability. This combination allows you to assemble a highly interactive graphics system with keyless, friendly control for real-time systems.

The 9111A/Opt 050 has all the features of a standard 9111A with some important additions; it can output data, via HP-IB, directly to a 1351A with minimal controller interaction. The controller can designate the 9111A/Opt 050 as the talker, the 1351A as the listener, then simply monitor the lines for a signal (SRQ) which says system controller action is needed. This allows the user to input data points, such as a cursor, rubberband lines or rectangle, directly to the 1351A at 60 times/sec for real-time movement on the system CRT display.

Symbols can be defined in the 1351A memory and recalled at the press of the tablet stylus. By using the pre-defined symbol as the cursor, the user can move it on the CRT screen and position it as needed by moving the tablet stylus. Complex drawings can be made on screen by moving and combining symbols previously defined. This eliminates the need to redraw often used symbols each time they are used. Interaction with a CRT screen menu can be obtained by having the controller software use the selective erase capability of the 1351S in conjunction with the high speed digitizing capability of the Graphics Tablet.

Graphics Tablet

The human-engineered slope and convenient size of the 9111A, and the bright, high resolution large screen display of the 1351S allow you to interact comfortably with a computer system. Writing on the tablet with the slim, lightweight stylus is less fatiguing than using a light pen on a CRT.

A graphic system that includes a computer/controller, a 9111A/Opt 050 Graphics Tablet, a 1351S Graphics Display System, and a digital plotter such as the 9872A/B/C, can be assembled using only one HP-IB interface bus. The HP-IB compatible 9111A/Opt 050 can be programmed as easily as the 1351A, allowing you to configure and debug your graphics system in a short time. The 1351S

Graphics Display System options give you four popular large screen displays (14 in. diagonal to 21 in. diagonal). These options plus a wide selection of HP-IB compatible plotters make it easy to match screen size and hard copy requirements to your specific applications.

Features

- Compatible with HP 1351S Graphics Display System (The 9111A/Opt 050/1351S combination provides direct display interactions for cursor movement, line and rectangle rubber banding, etc.)
- HP-IB compatible
- Human engineered stylus/tablet
- System engineered for minimum software development outlays and maximum host CPU utilization
- Programmable 4 octave beeper (with volume and duration control for audio feedback)
- Comprehensive self test
- Menu of 16 soft keys
- 36 mnemonic ASCII commands
- Capable of interrupt driven system operation
- High speed (up to 60 pts./sec.)

Sample Applications

- Real-time instrumentation systems (data acquisition/analysis, production testing)
- Real-time process control/monitoring
- Schematic generation
- Engineering design and evaluation (mechanical, electrical, chemical, physics, etc.)
- Architectural design (e.g., electrical or plumbing blueprints)
- NC machine tape verification
- Specification drawings
- Material for graphics presentations (drawings, graphs, etc., for overhead slides, handouts)

Ordering Information

9111A/Option 050 Graphics Tablet

\$2575

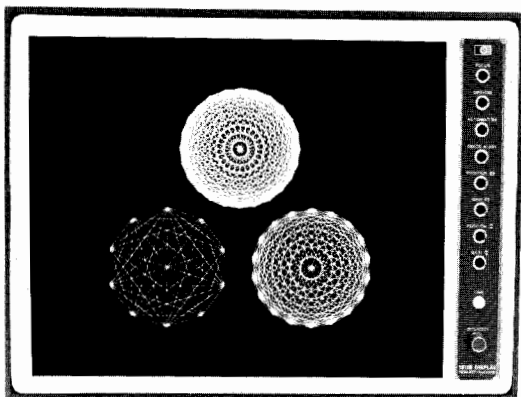

Complex processes such as valve closures and temperature or pressure changes can be shown in real time as in this computer generated 1311B display.

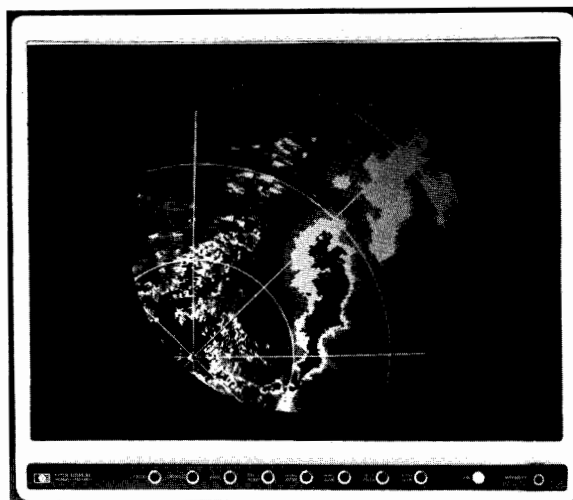

High speed vector generating capability allows accurate vector closure in high density graphic design as shown in this CAD application of the 1310B display.

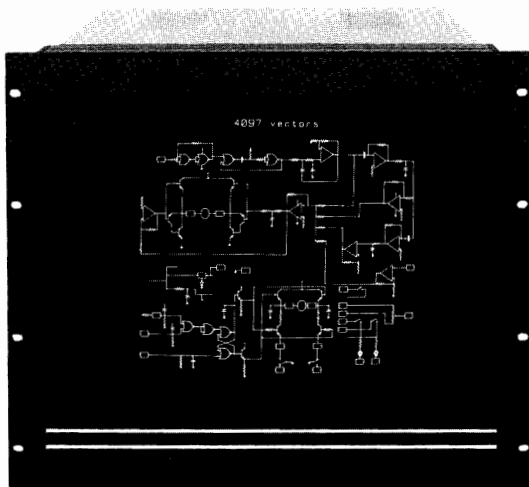

Ideal for standard rack mounting, the 1317A easily displays complex schematics.

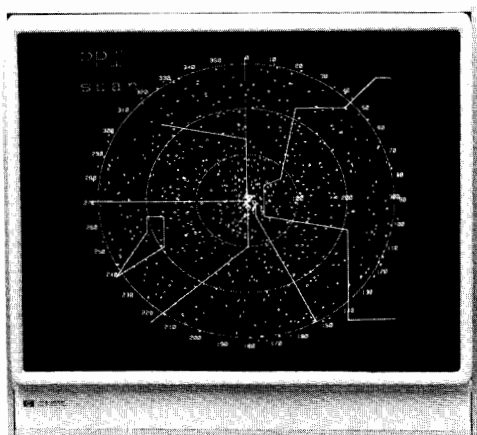

The 1321B can provide densely populated displays such as this PPI scan for simulation, training, or analysis of data. Small image resolution is maintained over the entire screen area.

Description

Hewlett-Packard's Models 1310B, 1311B, 1317A, and 1321B Large Screen Displays offer the high writing speed, fast settling time, brightness and contrast needed for the display of high density graphics information. These displays are ideal computer peripherals with the high picture quality and dynamic performance required for complex computer generated graphics. Any on-screen movement can be made in less than 500 ns, including settling time. This high speed performance is particularly useful in radar and simulation, where many symbols must be moved about almost simultaneously. It is also useful in computer-aided design (CAD) applications which require complex, high density drawing capability.

These high resolution displays remain exceptionally well focused in all parts of the screen which solves such difficult display problems as writing many characters around the picture edges, while showing great detail in curves, graphs, or diagrams. Excellent image quality is further assured with features such as a contrast control circuit which provides constant contrast with variations in intensity, and a flat, optical quality glass contrast filter which eliminates trace diffusion and minimizes glare.

The 1310B, 1311B, 1317A, and 1321B are electrically almost identical, but offer a wide range of sizes and configurations to fit almost any high-speed, large screen OEM display requirements. The 1321B has the highest overall resolution (screen area divided by spot size) of any HP CRT display, making it the choice for applications where maximum information density is the main consideration. The 1317A is ideal for standard 48.3 cm (19 in.) rack-mount applications requiring the largest possible screen area in the minimum vertical rack space. For table-top applications such as remote monitors, Models 1310B and 1311B offer an attractively styled enclosure with a tilt stand. Both displays may be ordered without the tilt stand (Opt 001) for mounting in standard 48.3 cm (19 in.) racks or custom designed enclosures.

Ordering Information

For information on options and accessories, refer to the applicable Large Screen CRT data sheet.

1310B 48 cm (19 in.) Display	\$6300
1311B 36 cm (14 in.) Display	\$5700
1317A 43 cm (17 in.) Display	\$5300
1321B 53 cm (21 in.) Display	\$6600
OEM discounts available	

CATHODE-RAY TUBE DISPLAYS

Imaging

Models 1332A, 1333A, 1335A & 1336S

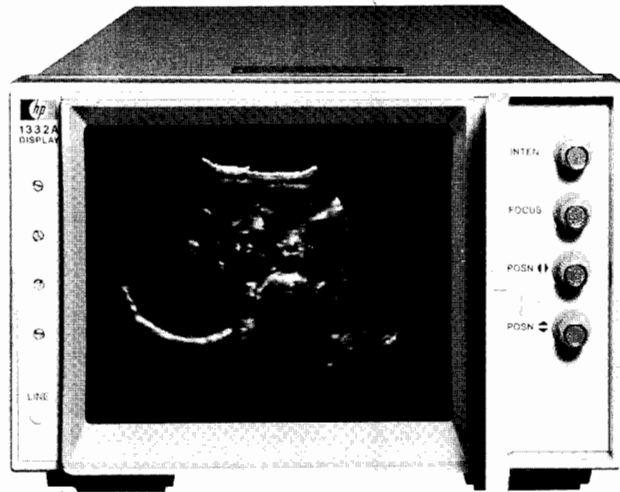

1332A

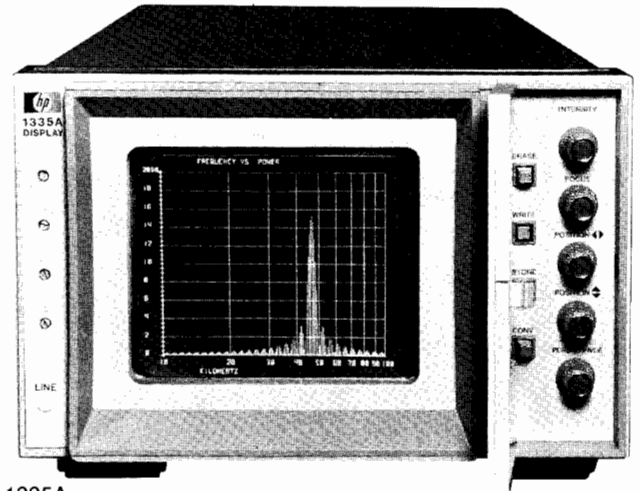

1335A

Introduction

Models 1332A, 1333A, 1335A, and 1336S are high-quality cathode-ray tube displays designed to satisfy a wide range of OEM medical and electronic instrument display needs. They provide optimum performance when used as continuous tone imaging displays. Continuous tone images are so called because the image space in the X-Y plane is filled with a continuum of brightness levels ranging from black to maximum brightness, where the brightness represents some physical parameter such as radar return amplitude, ultrasonic reflectivity of body tissues, etc., having a varying spatial distribution of magnitude.

Bright for Easy Viewing

Model 1332A: has a large 9.6×11.9 cm display area with the resolution and picture quality required for medical diagnosis systems plus a bright display for differentiating between many gray shades, or for viewing in brightly lighted areas. Option 530 provides even greater brightness with up to 500 cd/m^2 line brightness.

Spot size is only 0.3 mm over the entire quality area and over the full range of intensity levels. This resolution makes the 1332A well suited for applications requiring sharp focusing on multiple gray shades or varying writing speeds with frequent video drive level changes, e.g., alphanumeric characters mixed with traces, curves, or graphs.

The large viewing area and bright display make the 1332A ideal for the OEM with both visual and some photographic requirements. Display brightness lets you view the display in high ambient light conditions while maintaining resolution and gray shades for photographic work. Whenever uniform photographic recording of the display becomes critical, the 1333A or 1336S should be used.

Optimized for Photographing

Model 1333A: has a high resolution CRT with an 8×10 cm viewing area specifically optimized for photographic applications such as gamma camera systems. The 1333A's combination of high resolution, excellent uniformity, and speed permits crisp, easy-to-read, diagnostic-quality photographs to be obtained from state-of-the-art nuclear, ultrasonic, thermographic, and X-ray scanning systems.

Spot size is a crisp 0.2 mm everywhere on the 8×10 cm display, which allows resolution of 193 354 picture elements. The spot remains round and sharply focused in all areas of the screen and at varying intensity levels, eliminating the need to readjust focus or astigmatism controls.

Light output uniformity is fully specified, both overall and for small increments, which assures you that the information content of the display is an accurate representation of the input signals. Additionally, light output drift is specified, including all effects of the Z-axis amplifier, high voltage supply, and CRT. A regulated dc CRT filament voltage is also used to assure constant light output independent of line

voltage fluctuations. The regulated dc filament voltage also reduces the possibility of interference patterns resulting from correlation between input signal frequencies and the high voltage oscillator or power line frequencies.

Variable Persistence, Storage

Model 1335A: is a high resolution 8×10 cm storage display which offers medical and instrumentation OEM users a variable persistence storage CRT display with outstanding performance and picture quality.

In the non-storage mode (called CONVENTIONAL), the CRT operates similar to a mono-accelerator conventional CRT with an exceptionally small spot that focuses uniformly over the entire quality area. Resolution is approximately 40 lines per cm (100 lines per in.). In addition, spot size is relatively independent of intensity settings or Z-axis input signals, eliminating the need to refocus at each intensity setting. The storage writing speed remains stable through use of regulated CRT filament voltage and stable Z-axis amplifier design.

The same excellent CRT performance is maintained in the Variable Persistence operating mode. Persistence is continuously adjustable with a front panel control from approximately 0.20s to > 1 minute. This mode allows you to eliminate flicker on some presentations by increasing the persistence to match the refresh rate. The variable persistence mode is selected by pressing the WRITE pushbutton.

The storage CRT is preset to store dots having a Z-axis width of $1 \mu\text{s}$ or greater for up to 30 minutes. The STORE mode offers the greatest contrast because the background is completely dark. Stored resolution is over 20 lines per cm (50 lines per in.) and stored traces retain sharp details for up to 1 minute in WRITE mode, 30 minutes in STORE mode.

The Model 1335A offers users flexibility in selecting ERASE, STORE, WRITE, CONVENTIONAL, and VARIABLE PERSISTENCE modes. These modes can be selected with the manual front panel controls, remote program inputs, or a combination of both.

Resolution up to 140 lines/cm

Model 1336S: consists of an 8×10 cm display module (1336A) and a separate power supply module (1336P) for mounting flexibility. The display offers a choice of 140 lines/cm or 90 lines/cm (Option 005) resolution for all high-resolution imaging requirements such as multi-imaging for nuclear or ultrasound medical diagnostic systems, scanning electron microscopes, and scanning auger microprobes. A mono-accelerator CRT with an accelerating potential of approximately 5 kV produces a small, high intensity spot with only 100 watts power consumption.

The CRT is designed to prevent spurious light from reaching photographic film during long time exposures. Light output uniformity is tested to assure that the information content of the displayed image is an accurate representation of the input signals.

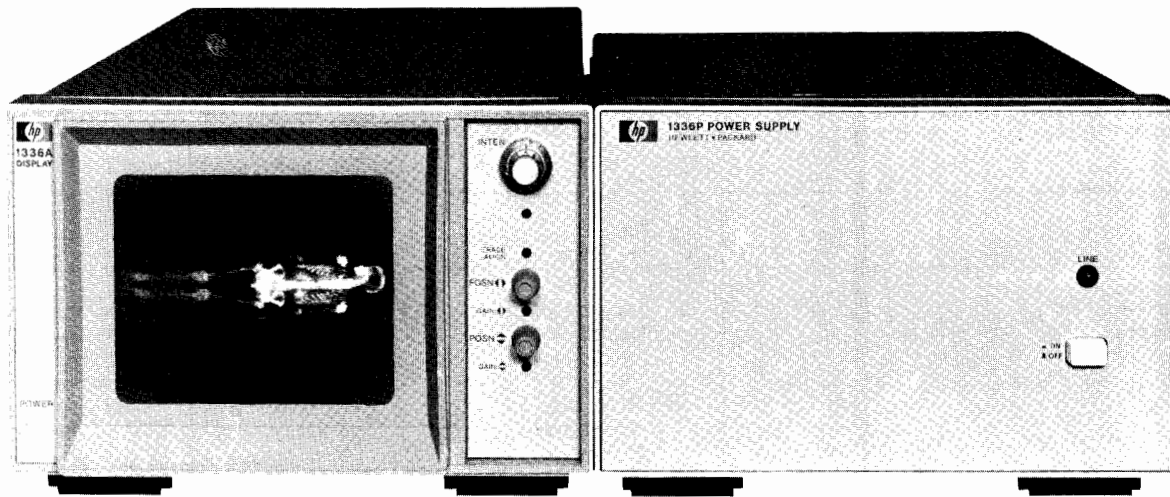

1336S

CRT's

The 1332A, 1333A, and 1335A have post deflection accelerator CRT's to assure a bright, crisp trace. The 1336S display uses a mono-accelerator CRT design to achieve 140 lines/cm resolution at center screen with low power consumption. An opaque aluminum layer behind the phosphor (except in model 1336S, which is non-aluminized) enhances trace brightness.

Regulated, low power write gun and flood gun filaments assure a constant light output under varying line voltage conditions. More importantly, the low power filament operation significantly extends CRT life and eliminates grid and other stray emissions common to older, less efficient designs.

Models 1332A, 1333A, 1335A (Opt 330), and 1336S are listed with Underwriters Laboratories in accordance with the UL 544 Medical Safety Standard which defines detailed patient protection requirements. Regular inspection of our production facility by UL assures you that this patient protection is built into the display that you purchase.

Electronics

Models 1332A, 1333A, and 1335A

The X and Y amplifiers have 70 ns rise time (bandwidth is 5 MHz) and the Z-axis blanking amplifier has a 25 ns rise time. When faster X and Y amplifier response is required, Model 1332A has an Option available to obtain 25 ns rise times. All amplifiers are fully differential and operate at low power levels for stable, drift-free performance over wide ranges of operating temperatures.

The time required to make any size movement on the CRT, including the response time for the amplifiers to settle within one spot diameter of final position, is less than 300 ns. This means that many thousands of vectors and characters can be written on the display without flicker.

Model 1336S (1336A and 1336P)

The 1336A's deflection amplifiers settle to within one spot diameter in <math>< 500\text{ ns}</math> after receiving an input step command. All amplifiers are fully differential and operate at low power levels for stable operation and minimum warm-up time. Dynamic focus circuits automatically correct for spot position to assure optimum resolution over the entire CRT face. A regulated dc CRT filament supply assures a stable light output.

Interfacing flexibility is provided by internal switches which allow selection of X, Y, and Z amplifier input characteristics. An optional TTL blanking input unconditionally overrides any analog Z-axis input and the intensity control, and can be used to provide CRT protection in the event of CRT failure.

Cabinet Sizes

Models 1332A, 1333A, and 1335A are 13.3 cm (5¼ in.) high, half rack width, 49.5 cm (19½ in.) long packages that can be combined with identical empty modules to form an attractive full width horizontal or vertically stacked OEM instrument. The 1336A Display Module has the same dimensions and the 1336P Power Supply Module has the same height and width but is 33.5 cm (13⅜ in.) deep. If the 1336A/P are to be mounted together, 1336P Option 018 may be ordered to provide the same cabinet depth as the 1336A, with locking hardware to form a standard EIA rack width unit.

Options and Accessories

A wide range of options is available for tailoring the display to specific requirements; refer to data sheets for complete listing. Accessories available include rack mounting kits, OEM half module frames and rack slides, a light shield (Model 10183A), and BNC shorting caps for use with certain options. For convenient system interconnection, Model 10488A 3.6 m (12 ft) Display Cable is available as an accessory. Model 197B Option 006 camera is adapted for direct recording of 1332A, 1333A, 1335A, and 1336S displays. Refer to individual display data sheets for complete description of accessories.

Ordering Information

	Price
1332A Small Screen Display	\$2050
1333A Small Screen Display	\$2300
1335A Small Screen Display	\$2750
1336A Display Module	\$2950
1336P Power Supply Module	\$950
1336S Display System (includes 1336A, 1336P)	\$3900
1336A or 1336S Opt 005	Less \$300
10184 Light Shield for 1332A, 1333A, 1335A, 1340A, 1338A	\$15

OEM and quantity discounts available.

CATHODE-RAY TUBE DISPLAYS

Phosphor Selection Guide

Choosing a Phosphor

The following tables will assist you in choosing the phosphor best suited to your application, and in determining the best combination of display, phosphor, film, and contrast filter. Also listed are important characteristics of some commonly used phosphors.

P31 phosphor is the first choice for imaging requirements with refresh rates of 50Hz or above. It is the brightest phosphor, i.e., has the greatest energy conversion efficiency. Its peak emission wavelength corresponds to the eye's peak spectral response for maximum cou-

pling efficiency between the eye and the phosphor. Also, P31 is the most burn resistant phosphor known, and is commonly available. In real time ultrasound systems with refresh rates from 20 to 40Hz, P4 phosphor is a good choice with its longer persistence and black and white appearance. For M-mode ultrasound, P39 phosphor is recommended. There is no phosphor with long enough persistence to be useful for direct viewing in nuclear medicine. In this case the 1335A variable persistence display is recommended.

Film Type	Phosphor		
	P31	P11	P4
Kodak*			
NMB (formerly SO-179)	Recommended	Usable	Usable
NMC (formerly SO-241)	Recommended	Usable	Usable
X-OMAT G	Not Usable	Recommended	Not Recommended
X-OMAT L	Not Usable	Recommended	Not Recommended
X-OMAT M	Not Usable	Recommended	Not Recommended
CFA	Recommended	Usable	Usable
PF	Recommended	Usable	Usable
PFC	Recommended	Usable	Usable
Shellburst 2476	Not Recommended	Recommended	Not Recommended
Du Pont® MRF 31, MRF 32	Recommended	Usable	Usable
Polaroid®			
611	Recommended	Usable	Usable
811	Recommended	Usable	Usable
084	Recommended	Usable	Usable
667	Recommended	Usable	Usable

Note: Cameras with a UV light, e.g., 197B, work well with P31, P11, and P7 phosphors, not as well with P4, and do not work with P39.

*Registered Trademark of Eastman Kodak Company.

®Registered Trademark of E. I. Du Pont De Nemours.

Application	Recommended Model(s)	Recommended Phosphor	Recommended Contrast Filter
Medical Diagnostic Ultrasound			
Real-time Linear Array	1332A	P4	Neutral Gray
Real-time Phased Array	1332A	P31	Blue
M-Mode	1332A	P39	Blue
A-Mode	1340A	P31	Blue
Nuclear Medicine			
Single-image Photographic Recording	1333A	See Film/ Phosphor table	Clear
Multiformat Photographic Recording	1336S	" "	Clear
Patient Positioning	1335A	P31	Blue
Scanning Auger Microprobe, Scanning Electron Microscope	1336S	P11 or P31	Clear

Note: Filters and implosion shields are made of a polycarbonate material which does not transmit UV light. For photographing with UV sensitive film and UV emitting phosphors such as P11 or P16, the implosion shield or filter should be removed. Provision must be made to insure that the camera is locked in place and provides adequate implosion protection to the display operator.

Phosphor	P31	P4	P39	P11	P7
Color					
Flourescence	Green	Blue	Green	Blue-Violet	Blue-Violet
Phosphorescence (decay)	Green	Yellow	Green	Blue-Violet	Yellow-Orange
Efficiency (relative to P31)	100%	50%	50%	100% (note 1)	40%
Flicker Frequency	50 Hz	30 Hz	20 Hz	N/A (note 2)	10 Hz
Smear Velocity	*	10"/s	0.1"/s	*	0.01"/s
Burn Resistance	Highest	Good	Good	Poor	Poor
Recommended Contrast Filter	Neutral Gray or Blue	Neutral Gray	Neutral Gray or Blue	None (note 2)	Amber

* Persistence is short enough that no smearing is visible in rapidly changing pictures.

Note 1: P11 efficiency is given relative to radiometric measurement; all others are as measured photometrically.

Note 2: P11 is not recommended for direct viewing applications. Its primary use is in photography.

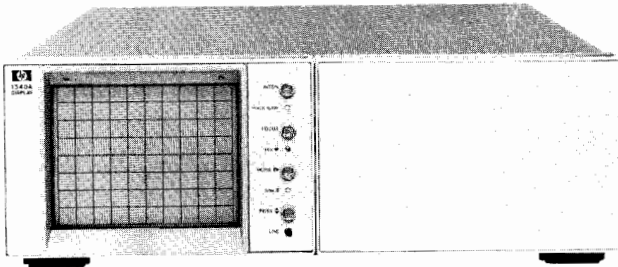

1340A Option 316 assembled in a 10380A OEM cabinet

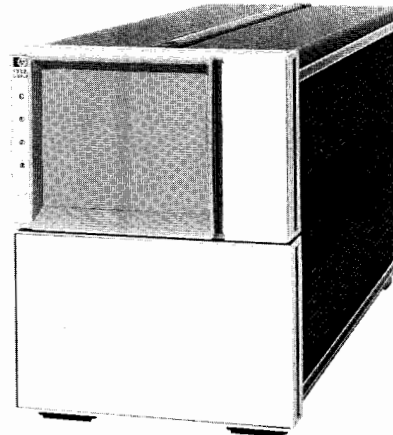

1332A Display with the 10386A vertical OEM cabinet

All HP small-screen displays—the 1332A, 1333A, 1335A, 1336S, and 1340A—use the HP System II cabinet and frame structure, which affords the OEM an extremely flexible choice of attractive, rugged, electrically and thermally optimized building blocks with which to assemble a complete instrument or system around the display. The standard versions illustrated, Model 10380A Horizontal OEM Package and Model 10386A Vertical OEM Package, provide approximately 660 cubic inches of useable space for your circuitry, with combining covers to provide a unitized appearance. Power dissipation in added circuits should be limited to 50 watts. All necessary combining hardware, frame castings, trim, etc., are included. Rack mounting kits, slide mounting kits, and handles are available for the Model 10380A Horizontal OEM Package. Detailed drawings are available on request to aid in mechanical design and documentation. Special configurations can be quoted on request. The display and OEM packages shown can be painted in any desired color or silk-screened with customer-specified logos or other artwork.

Note: Model 1340A display requires Option 316 for use with the 10380A or 10386A. Refer to the 1340A data sheet for a description of Option 316 in addition to Options 315 (1340A display module with half-rack width cabinet) and 317 (1340A display module with full rack width cabinet).

OEM Cabinets and Accessories

For complete listing of display options, see individual data sheets.

10380A OEM Horizontal Frame \$200

Model 10380A Frame Kit provides an empty 13.4 cm (5.25 in.) high half-module frame for mounting on the left or right of a display. The kit includes locking hardware for side-by-side mounting; combining covers (covers supplied with Option 315 or 330 are not required with this kit); side covers with strap handles for both sides; and blank panels for the empty module.

10382A Bench Hardware Kit for 10380A \$30

Model 10382A Bench Hardware Kit provides hardware for finishing the 10380A for bench use. The kit includes plastic trim for the front handles, plastic feet, tilt stands, and front rack handles.

Rack Mounting for OEM Frame or Two Displays

Rack mounting the Model 10380A OEM frame requires either a Rack Flange Kit HP P/N 5061-0077 or a Rack Flange and Front Handle Combination Kit HP P/N 5061-0083. To rack mount two displays, a Cabinet Lock-together Kit HP P/N 5061-0094 is required in addition to one of the rack flange kits. Two displays may also be combined and rack mounted.

Cabinet lock-together kit P/N 5061-0094: \$42

The Cabinet Lock-together Kit joins equal length instruments and contains enough hardware and screws for joining instruments in several configurations. The kit includes enough horizontal links (12 front, 6 rear) to form three side-by-side joints and enough vertical links (4 front, 4 rear) to form two over-under joints.

Rack flange kit P/N 5061-0077: \$25

the Rack Flange Kit provides rack mounting for the Model 10380A OEM Horizontal Frame or two side-by-side displays. The kit includes two flush rack ears without handles that fit on each side of the 13.3 cm (5.25 in.) high front panel frame and attaching hardware.

Rack flange, front handle combination kit P/N 5061-0083: \$55

the Rack Flange and Front Handle Combination Kit provides rack mounting for the Model 10380A OEM Horizontal Frame or two side-by-side displays. The kit includes two rack flanges and front handle combinations that fit on each side of the 13.3 cm (5.25 in.) high front panel frame and attaching hardware.

Rack Mounting Adapter Kit P/N 5061-0057 \$45

The Rack Mounting Adapter Kit allows mounting one display in a standard 48.3 cm (19 in.) EIA rack when not using the Model 10380A OEM Horizontal Frame. This kit includes a 13.3 cm (5¼ in.) high half rack adapter plate with an integral rack ear, one rack flange for the display, and attaching hardware.

10386A OEM Vertical Frame \$200

Model 10386A Frame Kit provides an empty half-module for mounting above or below a display. The kit includes locking hardware for mounting above or below the display; top and bottom covers (covers supplied with Option 315, 330, 332, or 333, are not required with this kit), combining side covers, blank panels for the empty module, and cabinet trim.

Rack Slide Kits

When mounting two displays on slides, they must be fastened together using the cabinet lock-together kit HP P/N 5061-0094 and one rack flange kit HP P/N 5061-0077 or, one rack flange/front handle combination kit HP P/N 5061-0083. With either slide kit, bracket kit HP P/N 1494-0023 is required for mounting in racks other than HP racks.

Non-pivoting slide kit P/N 1494-0017: \$75

includes two slides and accessory hardware for attaching to a Model 10380A or two displays

Pivoting slide kit P/N 1494-0026: \$145

includes two pivoting slides and accessory hardware for attaching to a Model 10380A or two displays.

Slide adapter bracket kit P/N 1494-0023: \$45

includes brackets for mounting either pivoting or non-pivoting slides in non-HP rack system enclosures.

197B Option 006 Camera \$1250

For HP small screen displays (see page 216)

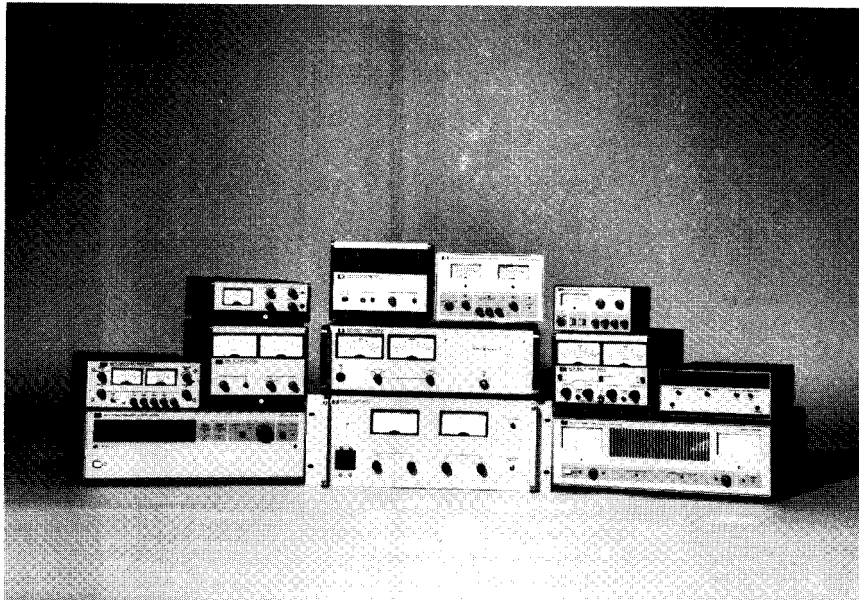

Introduction

Hewlett-Packard power supplies are available in many types, sizes, and ratings. There are laboratory supplies used in circuit development, modular supplies to power systems, high-power supplies for industrial processes, and many special purpose supplies ranging from constant-current sources to bipolar power supply amplifiers.

The True Value of a Power Supply

The best power supply for the job must first satisfy all the physical criteria: voltage and current ratings, performance specifications, size, and features. But equally important are the less tangible aspects that affect the real cost of ownership. Such factors as the experience and expertise of the manufacturer's engineering staff should be considered. Are his designs conservative—does he use quality components, does he have established QA procedures?

If you have a problem or need application assistance, are the manufacturers' reps accessible, responsive, and knowledgeable? Are spare parts and service available on a world-wide scale?

These factors do not show up on a spec sheet, but are closely related to a company's capability and responsibility towards its customers. When you purchase a power supply from Hewlett-Packard, you receive guaranteed product performance plus the intangibles that add up to long-term value—and it usually costs no more.

Regulation Techniques

HP power supplies are designed using one of four proven stabilization techniques: series, switching, SCR, and SCR preregulator/series regulator.

Series Regulation: this technique uses a feedback loop to control the voltage drop

across a series-pass transistor located between the rectified dc input and the output terminals of the power supply. The feedback network senses changes in the output voltage and develops an error signal which adjusts the drop across the series transistor such that it maintains the output terminal voltage at the desired level. Good regulation (0.001% to 0.05%), low ripple and noise (50 μ V to 1 mV), and fast transient response (<50 μ s) characterize this type of regulator.

With all its attributes of excellent performance and circuit simplicity, the series regulator has one drawback; it is relatively inefficient (typically 30 to 40%). Heat sinks are employed to dissipate the heat generated by the series transistors and this necessarily increases the size and weight of the supply.

All linear OEM modular and low power lab supplies use this technique.

Autoranging series regulation: this technique uses a pair of triac switches with appropriate control logic to automatically select different transformer secondary taps depending on the output voltage and current demand placed on the supply, and the AC input voltage and frequency. Several voltage-current combinations can thereby be supplied from the input rectifier to the following series regulator. This extends the range of voltage (or current) output available within the power rating of the supply beyond that obtained from a simple series regulator. Model 6002A uses this technique.

Switching regulation: this technique regulates the output voltage by essentially switching a series transistor on and off at a rapid rate (about 20 kHz) and delivering this "chopped" current to an output filter. A feedback network senses changes in the output and feeds back a correction signal which adjusts the transistors on-off duty cycle to

maintain a constant output voltage. Since a transistor dissipates very little power when it's fully on or off, the regulator has excellent efficiency (typically 65-80%).

Besides low power dissipation, another advantage of this technique is that the high pulse repetition rates make possible the use of transformers, inductors, and filter capacitors that are much smaller than those required for operation at power line frequencies.

Stabilization performance of the switching regulator is somewhat lower than the series regulator (typically 0.2% regulation; 20 mV rms, 40 mV p-p ripple and noise) but well suited for the majority of OEM system applications.

Autoranging Switching Regulation: This technique utilizes pulse-width modulation in conjunction with the principle of inductance-flyback voltage generation. Unlike a conventional power supply which can provide maximum power at only one combination of output voltage and current, the autoranging supply provides maximum power over a wide range of output voltages and currents.

SCR regulation: In many high power applications, the tight regulation and low ripple and noise characteristics of the series regulator can be beneficially traded for economy, efficiency, and compact size. This is where the SCR regulator is most valuable. Typical performance specifications for SCR supplies are 0.05 to 1% regulation, 50 mV rms, 500 mV p-p ripple and noise, 50-200 ms transient response, and 70% efficiency. Regulation is accomplished by sensing both the AC input and DC output of the supply and generating a firing pulse for SCR's located in two legs of a bridge rectifier. If the output voltage tries to decrease, the control circuit generates the firing pulse earlier in the input half cycle. More voltage is then passed through the SCR to the output filter to raise the output voltage to the correct level.

SCR Pre-regulator/ Series Regulator: this technique incorporates the best of both worlds, and is used in most medium to high power, high performance power supplies. In these supplies, the SCR pre-regulator changes the rectifier output in coordination with the output voltage of the supply so that only a small voltage drop is maintained across the series pass transistor. This reduces the power dissipation in the series elements and greatly improves the efficiency (up to 70%). Typical performance specifications are similar to series regulated supplies except for slower transient response.

Selecting Power Supplies

By model number: if you know the model number, you can find the power supply description page from the numerical index in the front of this catalog.

By voltage rating: the condensed listing on the following two pages lists power supplies in order of output voltage rating. The referenced catalog page covers detailed specifications.

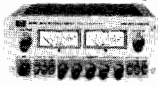

6205C

General Purpose

Pages 255 to 265

A broad selection of bench and rack-mounted power supplies for general laboratory, system and high-power applications. Ratings from 7.5 to 600 volts and from 10 Watts to 10 kW.

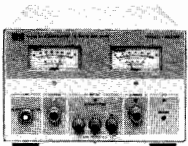

6024A

Autoranging

Pages 260 and 266

Autoranging power supplies can give maximum output power over a wide and continuous range of output voltage and current combinations without having to manually select the proper output range. This differs from conventional power supplies which can provide maximum rated power only at maximum voltage.

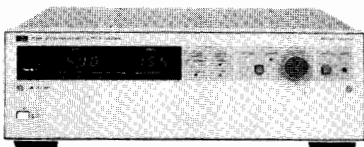

6034A



Digital Programmable

Pages 266 to 271

For automatic test, measurement and control applications. Includes HP-IB autoranging power supplies, binary and BCD digital voltage and current sources with high-speed bipolar output. HP-IB isolated D/A and power supply programmer.



6114A

Special Purpose

Pages 273 to 277

Laboratory power supplies with specific features enhanced for specialized applications including high-voltage power supplies, precision voltage sources, constant current sources and bipolar power supply/amplifiers.

65000A
-series

Modular

Pages 279 to 281

Switching and linear regulated modular power supplies with up to six fixed-voltage outputs. Output ratings range from 10 to 550 Watts.

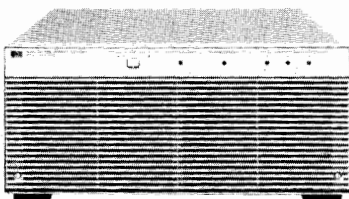

6942A



Multiprogrammer

Pages 55 to 61

Two models of highly versatile I/O expanders and converters that control up to 128 or 240 power supplies from one HP-IB port or a 16-bit duplex I/O channel (6940B). They will control output voltage and current of power supplies listed with a ★ symbol on the next page.

Options and Accessories

Page 278



POWER SUPPLIES

Condensed Listing

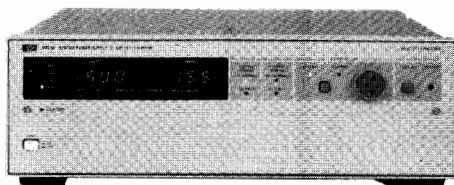

6034A—page 266

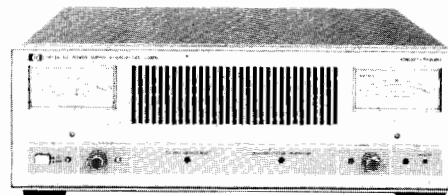

6012A—page 260

Variable Output

DC Volts	DC Amps (Max.)	Notes	Model	Page
4-5.5	8		6384A†	255
0 ± 5 & ± 20	1	BPSA*	6825A†	277
		Dual Range		
0 ± 5 & ± 50	1	BPSA*	6826A†	277
		Dual Range		
0-6, 0 ± 18	1 & 0.2	Triple Output	6235A†	256
0-6, 0 ± 20	2.5 & 0.5	Triple Output	6236B†*	256
0-7.5	3		6203B†	256
0-7.5	5		6281A†♦♦	258
0-8	1000		6464C†♦♦	264
0-10	1		6214A†	255
0-10	2	Prec. Volt	6113A†♦♦	274
0-10	10		6282A†♦♦	258
0-10	50		6259B†♦♦	262
0-10	100		6260B†♦♦	262
0 ± 10 & 0 ± 10	0.5	BPSA*	6827A†	277
		Dual Range		
0-15	200		6453A†♦	264
0-16 or 0-18	600 or 500		6466C†♦♦♦	264
0-18 & 0- ± 20	1 & 0.5	Dual Tracking	6237B†	256
0 ± 18, 0-6	0.2 & 1	Triple	6235A†	256
0 ± 20, 0-6	0.5 & 2.5	Triple	6236B†	256
0 ± 20, 0-18	0.5 & 1	Triple	6237B†	256
0-20 & 0-40	0.6 & 0.3	Two Dual Range Outputs	6205B†♦♦	255
0-20	1	Prec. Volt.	6111A†♦♦	274
0-20 & 0-40	1.5 & 0.75	Dual Range Outputs	6200B†	255
0-20 & 20-40	2 & 1	Prec. Volt.		274
		Dual Range	6114A†♦♦	
0-20	3	Gen. Purpose	6284A†♦♦	258
0-20 & 0-20	3 & 3	Two Outputs	6253A†♦♦	258
0-20	10	Autoranging	6024A†*	260
0-20	10	HP-IB/Auto.	6034A†*	266
0-20	10		6263B†♦♦	262
0-20	10		6286A†	258
0-20	20		6264B†♦	262
0-20	45		6428B†♦♦	264
0-20	50	Autoranging	6012A†*	260
0-20	50		6261B†♦♦	262
20-40 & 0-20	1 & 2	Prec. Volt.		274
		Dual Range	6114A†♦♦	
0-24	3	Gen. Purpose	6224B†♦♦	258
0 ± 25	0.2 ea.	Dual Output	6234A†	255
0-25	0.4		6216A†	255
0-25 & 0-25	2	Tracking Outputs	6227B†♦♦	272
0-30 & 0-60	1 & 0.5	Dual Range	6206B†	255
0-36	10		6433B†♦♦	264
0-36	100		6456B†	264
0-36	300		6469C†♦♦♦	264
0-40 & 0-20	0.3 & 0.6	Dual Range	6205B†	255
0-40	0.5	Prec. Volt	6112A†♦♦	274
0-40 & 0-20	0.75 & 1.5	Dual Range	6200B†	255
0-40 & 0-40	1.5 & 1.5	Two Outputs	6255A†	258
0-40	1.5		6289A†♦♦	258
0-40	3		6265B†♦♦	262

Variable Output

DC Volts	DC Amps (Max.)	Notes	Model	Page
0-40	5		6266B†♦♦	262
0-40	5		6291A†♦	258
0-40	5.7	Autoranging	6024A†*	260
0-40	5.7	HP-IB/Auto	6034A†*	266
0-40	10		6267B†♦♦	262
0-40	25		6434B†♦♦	264
0-40	30	Autoranging	6012A†*	260
0-40	30		6268B†♦♦	258
0-40	50		6269B†♦♦	258
0-50	0.2		6218A†	255
0-50 (Compliance)	0-0.5	Prec. Cur.	6177C†♦	276
0-50 & 50-100	0.8 & 0.4	Prec. Volt	6115A†♦♦	274
		Dual Range		
0-50 & 0-50	1	Tracking Outputs	6228B†♦♦	272
0-50	1.5		6226B†♦♦	258
50-100 & 0-50	0.4 & 0.8	Prec. Volt.	6115A†♦♦	274
		Dual Range		
0-50	10-4	HP-IB	6002A†	268
0 ± 50	5	Dig. Prog. Volt.	6129C†	270
0 ± 50	1	Dig. Prog. Volt.	6130C†	270
0 ± 50	1	BPSA*	6824A†♦	277
0-60 & 0-30	0.5 & 1	Dual Range	6206B†♦♦	255
0-60	1		6294A†♦♦	258
0-60	3		6296A†♦	258
0-60	3		6271B†♦♦	262
0-60	3.3 at 60V	Autoranging	6024A†*	260
0-60	3.3 at 60V	HP-IB/Auto.	6034A†*	266
0-60 Autoranging	10 (200 W)	Autoranging	6024A	260
0-60	5		6438B†♦♦	264
0-60	15		6274B†♦♦	258
0-60	15		6439B†♦♦	264
0-60	17.5 at 60V	Autoranging	6012A†*	260
0-60 Autoranging	50 (1000 W)	Autoranging	6012A	260
0-64	50		6459A†♦	264
0-64	150		6472C†♦♦♦	264
0-100 (Compliance)	±0.016	Dig. Prog. Cur.	6140A†	270
0-100	0.1		6212A†	255
0-100	0.2	Prec. Volt.	6116A†♦	274
0-100 (Compliance)	0.25	Prec. Cur.	6181C†♦	276
0-100	0.75		6299A†♦♦	258
0 ± 100	0.5	Dig. Prog. Volt.	6131C†	270
0-110	100		6475C†♦♦	264
0-120	2.5		6443B†♦♦	264
0-160	0.2		6207B†♦	255
0-220	50		6477C†♦♦	264
0-300 (Compliance)	0.1	Prec. Cur.	6186C†♦	276
0-300	35		6479C†♦	264
0-320	0.1		6209B†♦	255
0-320	1.5		895A†	262
0-440 or 0-500 or 0-600	25 or 20 or 15		6483C†♦♦	264
1-600	1.5		6448B†	264
0-1000	0.2		6521A†	273
0-1600	0.005		6515A†	273
0-2000	0.1		6522A†	273
0-3000	0.006		6516A†	273
0-4000	0.05		6525A†	273

†Available on GSA Contract Number GS-OOS-27423.

♦May be used with the 59501A HP-IB Isolated D/A Converter/Power Supply Programmer.

♦♦Requires Option J30 for use with the 59501A Power Supply Programmer.

*May be used with the 6940B or 6942A Multiprogrammer when the power supply is equipped with Option 040.

*BPSA = Bipolar Power Supply/Amplifier.

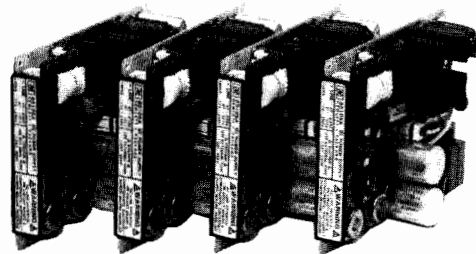
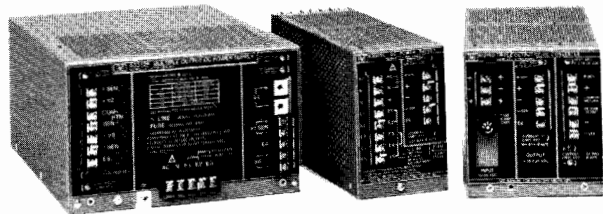

Fixed Output—See pages 279-281

DC Volts	DC Amps (Max.)	Notes	Model
5 ±0.50	2		62005A†
5 ±0.50	8		62005E†
5	10		65105A
5 & ±12	10 & 1.5, 50 W total	Triple Output	65321A
5 & ±15	10 & 1.0, 50 W total	Triple Output	65315A
5 & ±18	10 & 1.0, 50 W total	Triple Output	65317A
5	10	Five Outputs	65512A
±16	1.0		
5 to 12	0.3-1.0, 50 W total		
-5 to -12	0.3-1.0, 50 W total		
5	10	Six Outputs	65612A
±16	1.0		
5 to 12	0.3-1.0, 50 W total		
-5 to 12	0.3-1.0, 50 W total		
-5 to 12	0.1-0.3, 50 W total		
5 ±0.50	16		62005G†
5, & ±12 to 15,	18 & 2 A max	Triple Output	63315D†
4.75 to 5.25	50	Multi-output	63312F†
11.4 to +15.75	10		
-11.4 to -15.75	10		
5 ±0.25	22	DC-to-DC	61005C†
5 ±0.25	22		63005C†
5 & 12 to 15, ±0.25	18 & 2 A max	Triple Output	61315D†
		DC-to-DC	
		Fair Outputs	63341F
5	35		
24	5		
12	10		
12	6		
5	35	Five Outputs	63350F
24	5		
-12	9		
12	6		
-5	1		
5	50	Triple Output	63312F
+12 to 15	10		
-12 to 15	10		
5	50	Triple Output	63330F
12 to 15	10		
12 to 15	10		
5	85	Triple Output	63331F
+12	5		
-12	5		
5 ±0.25	60		62605L†
5	50		63340F
12 to 15	10		
12 to 15	10		
5	5		
5 ±0.25	100		62605M†
12 ±0.60	1.5		62012A†
12	4.2		65112A
12 ±0.60	6		62012E†
12 ±0.60	12		62012G†
±12 ±0.60 Dual	1.4		62212A†
±12 to ±15 Dual	17.5, 17.5		62615D
±12 to ±15 & 5 ±0.25	2 & 18 A max	Triple Output	63315D†
±11.4 to ±15.75	10	Multi-output	63312F†
-11.4 to -15.75	10		
4.75 to 5.25	50		
±12 ±0.60	3.3	Dual Output	62212E†
±12 ±0.60	6	Dual Output	62212G†
15 ±0.75	1.25		62015A†

†Available on GSA Contract Number GS-OOS-27423.

◆May be used with the 59501A HP-IB Isolated D/A Converter/Power Supply Programmer.

◆◆Requires Option J30 for use with the 59501A Power Supply Programmer.

*May be used with the 6940B or 6942A Multiprogrammer when the power supply is equipped with Option 040.

*BPSA = Bipolar Power Supply/Amplifier.

Fixed Output—See pages 279-281

DC Volts	DC Amps (Max.)	Notes	Model
15 ±0.75	5		62015E†
15 ±0.75	10		62015G†
±15 ±0.75	1.25	Dual Output	62215A†
±15 & 5 ±0.25	2 & 18 max		63315D†
±15 ±0.75	3	Dual Output	62215E†
±15	3.5		65115A
±15 ±0.75	5.2	Dual Output	62215G†
±15 to ±12	17.5, 17.5	Dual Output	62615D
24 ±1.20	3.75		62024E†
24 ±1.20	7.5		62024G†
28 ±1.40	0.7		62028A†
28 ±1.40	3.25		62028E†
28 ±1.40	6.5		62028G†
48 ±2.40	0.45		62048A†
48 ±2.40	2		62048E†
48 ±2.40	4		62048G†

†Available on GSA Contract Number GS-OOS-27423.

◆May be used with the 59501A HP-IB Isolated D/A Converter/Power Supply Programmer.

◆◆Requires Option J30 for use with the 59501A Power Supply Programmer.

*May be used with the 6940B or 6942A Multiprogrammer when the power supply is equipped with Option 040.

*BPSA = Bipolar Power Supply/Amplifier.

Power Supply Digital Programming Interfaces

Description	Model	Page
HP-IB Isolated D/A Converter/Power Supply Programmer: one channel, two programmable ranges. Provides HP-IB interface for programming either output voltage, or current (where current programming is available as described in specifications for individual power supply model) of power supplies designated with a ◆ or ◆◆ symbol in the adjacent condensed list "model" column. Interfacing details are covered in publication 5952-3990.	59501A	269
Multiprogrammer: Two models of highly versatile I/O expanders and converters that can control up to 240 power supplies from one HP-IB port or one 16-bit duplex I/O channel (model 6940B). They will control output voltage and current of power supplies designated with a ★ symbol in the adjacent condensed listing "model" column when the supplies are equipped with Option 040. Additional Multiprogrammer capabilities include digital I/O for monitoring crowbars, relays for output switching, A/D converters for measuring power supply output, timers for automatic power supply sequencing, etc. See pages 55-61 for more extensive descriptions of the individual Multiprogrammer capabilities and information on how to obtain complete technical data on the 6940B and 6942A Multiprogrammers.	6940B 6942A	55 58

Specification Definitions

Ambient temperature: the temperature of the air immediately surrounding the power supply.

Auto-parallel operation: a master-slave connection of the outputs of two or more supplies used for obtaining a current output greater than can be obtained from one supply.

Auto-series operation: a master-slave connection of the outputs of two or more supplies used for obtaining a voltage greater than can be obtained from one supply.

Auto-tracking operation: a master-slave connection of two or more supplies each of which has one of its output terminals in common with one of the output terminals of all of the other supplies.

Complementary tracking: a master-slave interconnection of two supplies in which the voltage of the slave is equal to or proportional to that of the master and of opposite polarity with respect to a common point.

Compliance voltage: the output voltage of a power supply operating in the constant-current mode.

Constant-current (CC) power supply: a power supply that stabilizes output current with respect to changes in influence quantities. Thus, for a change in load resistance, the output current remains constant while the output voltage changes by whatever amount necessary to accomplish this.

Constant-voltage (CV) power supply: a power supply that stabilizes output voltage with respect to changes in influence quantities. Thus, for a change in load resistance, the output voltage remains constant while the output current changes by whatever amount necessary to accomplish this.

Constant-voltage/constant-current (CV/CC) power supply: a power supply that operates as a constant voltage power supply or a constant-current power supply depending on load conditions. It acts as a constant-voltage source for comparatively large values of load resistance and as a constant-current source for comparatively small values of load resistance.

Constant-voltage/current-limiting (CV/CL) power supply: a power supply similar to a constant-voltage/constant current supply except that at comparatively small values of load resistance, its output current is limited instead of being stabilized.

Crowbar: see overvoltage protection.

Current limiting: the action of limiting the output current of a constant-voltage supply to some predetermined maximum value (fixed or adjustable) and automatically restoring the output voltage to its normal value when the overload or short circuit is removed. There are three types of current limiting: 1) by constant-voltage/constant-current crossover, 2) by decreasing the output voltage as the current increases, 3) by decreasing both voltage and current as the load resistance decreases (referred to as foldback or cutback current limiting).

Drift: the maximum change of an output voltage or current during an 8-hour period following a 30-minute warmup, with all influence and control quantities maintained constant during the warm-up time and the period of drift measurement. Drift includes both periodic and random deviations over the bandwidth from zero frequency (dc) to a specified upper frequency limit (usually 20 Hz).

Load effect: formerly known as load regulation, load effect is the change in the steady-state value of the stabilized output voltage or current resulting from a full-load change in the load current of a constant-voltage supply or the load voltage of a constant-current supply, with all other influence quantities maintained constant.

Load effect transient recovery time: the time interval between a specified step change in the load current of a constant-voltage supply (usually a full-load or 5-amp change, whichever is smaller) or in the load voltage of a constant-current supply and the instant when the stabilized output quantity returns to and stays within the specified transient recovery band.

Master-slave operation: a method of interconnecting two or more supplies such that one of them (the master) serves to control the others (the slaves). The outputs of the slave supplies always remain equal to or proportional to the output of the master. The outputs of the

master supply and of one or more slaves may be connected in series, in parallel, or with just their negative or positive output terminals in common. (See also complementary tracking.)

Nominal value: the value that exists "in name only," not the actual value. For example, in the case of a power supply with a calibrated output control, the nominal value is the value indicated by the control setting. For a supply with a fixed output, the nominal output is the output indicated on the nameplate. The nominal value of a 120-volt $\pm 10\%$ line voltage is 120 volts.

Output impedance: the complex ratio of a sinusoidal voltage and sinusoidal current at the output terminals, the one being caused by the other and being of external origin.

Overcurrent protection: protection of the power supply and/or connected equipment against excessive output current.

Overtemperature protection: protection of the power supply or parts of it against temperatures exceeding specified values.

Overvoltage protection: protection of the power supply and/or connected equipment against excessive output voltage. Overvoltage protection is usually by means of a crowbar protection circuit, which rapidly places a low resistance shunt across the supply's output terminals to reduce output voltage to a low value if a predetermined voltage is exceeded. A supply equipped with an overvoltage crowbar must also be protected by a means of limiting or interrupting output current.

PARD (acronym for periodic and random deviation): the term PARD replaces the former term ripple and noise. PARD is the periodic and random deviation of a dc output voltage or current from its average value, over a specified bandwidth (20 Hz to 20 MHz; except Models 6515A-6525A: 1 Hz to 20 MHz) and with all influence and control quantities maintained constant).

Programming speed: the maximum time required for the programmed output voltage or current to change from a specified initial value (usually zero or maximum output) to a value within a specified tolerance band of a specified newly programmed value (for most models 99.9% or 0.1% of maximum output, respectively; 99% and 1% for the 6111A-6116A, 6177C-6186C, and 6428B-6483C) following the onset of a step change in the programming input signal.

Remote control: also referred to as remote programming, remote control is the setting of the power supply voltage, current, or other function by means of an external control quantity such as a variable resistance, voltage, or current, or a digital signal.

Remote sensing: remote sensing, or remote error sensing, is a means by which a power supply monitors the stabilized voltage directly at the load using extra sensing leads. The resulting circuit action compensates for voltage drops in the load leads (up to a specified limit).

Resolution: the smallest change in output voltage or current that can be obtained using the front panel controls.

Reverse voltage protection: protection of the power supply against reverse voltage applied at the output terminals.

Slave operation: see master-slave operation.

Source effect: formerly known as line regulation, source effect is the change in the steady-state value of the stabilized output voltage on current resulting from any change in the source voltage within its specified range, with all other influence quantities maintained constant. Source effect may be measured at any output voltage and current within rating.

Temperature effect coefficient: the maximum steady-state change in a power supply's output voltage or current per degree Celsius following a change in the ambient temperature within specified limits, with all other influence quantities maintained constant.

Voltage limiting: the action of limiting the output voltage of a constant-current supply to some predetermined maximum value (fixed or adjustable) and automatically restoring the output current to its normal value when the load conditions are restored to normal. There are two types of voltage limiting: 1) by constant-voltage/constant-current crossover, 2) by decreasing the output current as the voltage increases.

Warm-up time: the time interval after switching on a power supply until it complies with all performance specifications.

- 10 Watts output . . . Low ripple and noise
- Compact, Impact-resistant stackable case
- Short-circuit proof

- 30 watts output
- Multi-function meter
- Remote sensing

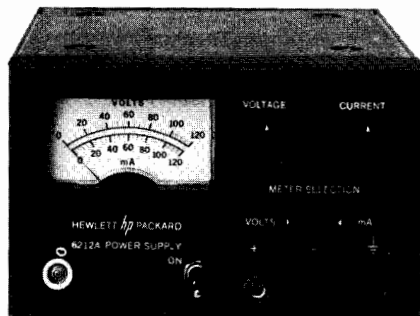

Single Output: 6212A-6218A

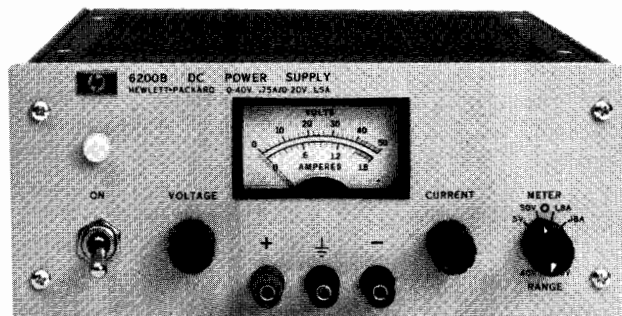

Single Output: 6200B-6203B, 6207B, 6209B (6206B and 6384A have fixed current limit without current controls)

Description—Single Output Models

Models 6212A-6218A

These popular low-cost bench supplies are designed for general laboratory use and are equipped with front-panel mounted voltage controls, a combination volt/ammeter, and output binding posts. Output voltage is continuously variable, via coarse and fine controls from 0V to 15% above the maximum rated output. A switch selects either output voltage or current for display on the panel meter.

Load connections are made via three binding posts. Either the + or the - post may be grounded through an adjacent GND terminal or the supply may be operated floating at up to 300 volts above ground.

These Constant Voltage/Constant Current supplies have concentric coarse and fine current controls which allow setting the current-limit point to any value within the current rating. Using these controls the supplies can also be operated as constant current sources with 500 μ A load regulation. All CV/CC models can be connected in series or parallel.

The molded, impact-resistant case includes an interlocking feature for stacking several units vertically, thus minimizing bench space required for multiple supplies. Alternatively, up to three units can be mounted side by side in a 19" rack using Rack Mounting Kit 14521A. These supplies measure 86H x 133W x 368mm D (3.40" x 5.25" x 8") and weigh 2kg (4.4 lb).

Models 6200-6209B

This series of low-cost bench supplies includes eight models covering an output voltage range from 0–7.5 V to 0–320 V. All models equipped with coarse and fine output voltage controls (except Models 6207B and 6209B, which have 10-turn voltage controls), volt/ampere meter, meter function/range switch, and front and rear output terminals. In addition, on the dual-range models (6200B and 6206B), an output range switch permits the selection of either a high or a low output voltage range.

The Constant-Voltage/Current-Limiting supplies are short-circuit protected by a fixed current limiting circuit which is activated at approximately 110% of rated load current. The current-limit point can be reduced by changing the value of a single internal resistor. For the Constant-Voltage/Constant-Current supplies, concentric coarse and fine current controls allow the current-limit point to be set to any value within the current rating. Using these controls the CV/CC supplies can also be operated as constant-current sources.

Units may be bench operated or rack mounted individually or in pairs using accessory rack mounting hardware.

Model 6384A

This low-cost bench supply is designed specifically for use with digital-logic integrated circuits. Its output ratings and superior performance, combined with the protection of built-in overvoltage crowbar and current limiting circuits, make it an excellent IC supply for both laboratory and systems use.

All models in this groups of supplies measure 89H x 216 W x 317mm D (3.50" x 8.50" x 12.50") and weigh 4.5kg (10 lb).

Description—Dual Output Models

Model 6234A

Model 6234A is a low-cost, dual-output bench power supply with two independently adjustable and isolated power sources in one compact unit. Both of the dc power sources are of the constant voltage/current limit type with each output voltage being adjustable continuously over a 0 to 25V range. The maximum current available per output is 0.2A and is limited automatically to prevent over-load.

The HP 6234A offers considerable flexibility to the user with output voltages that can be arranged to provide identical or different voltages in any polarity combination with respect to 0 or other common positive or negative voltage points. The outputs can also be connected in series to provide up to 50V at 0.2A. Both sources are fully isolated to permit either of the output terminals to be grounded.

With pushbutton switches, users can select either voltage or current for each output to be monitored on the unit's meter. Other features include two multiple-turn controls for precise voltage setting, regulation to 0.01% and ripple and noise of less than 200 microvolts rms.

With dimensions of only 93 mm high, 157 mm wide and 210 mm deep (3.64" x 6.17" x 8.25"), the HP 6234A supply takes up a minimum amount of bench space. Its weight is 2.3 kg (5 lbs.). The unit can be powered from a 115V or an optional 230V, 47-63Hz ac input, (Option 028).

Model 6205C

This low-cost bench supply is equipped with coarse and fine output voltage controls, volt/ampere meter, meter function/ range switch, and front and rear output terminals. In addition, an output range switch permits the selection of either a high or a low output voltage range.

Model 6205C combines the versatility of a dual power supply with the flexibility of auto-parallel and auto-series operation to extend the output ratings of this supply to 20 V/1.2 A, 40 V/0.6 A, and 80 V/0.3 A. In addition, using the supply's auto-tracking capability, opposite

POWER SUPPLIES

Laboratory: Single & Multiple Output, 10 W to 30 W

Models 6200B-6218A, 6234A-6237B & 6284A

- 10 watts output, Model 6234A
- Short-circuit proof
- Independent voltage controls

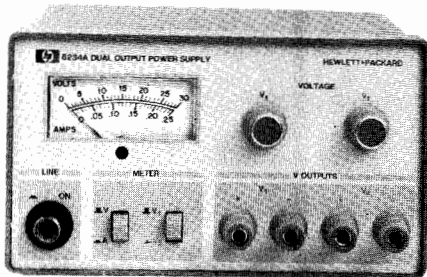

DUAL OUTPUT: Model 6234A

- 24 watts output, Model 6205A
- Multi-function meter

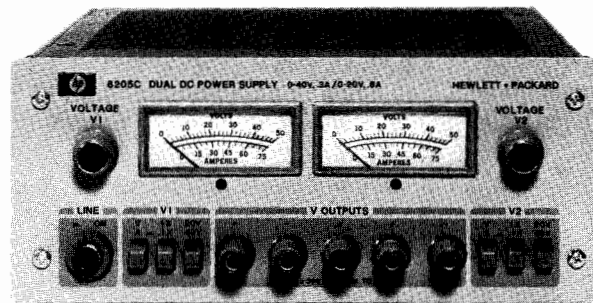

DUAL OUTPUT: Model 6205C

polarity voltages (± 20 V, ± 40 V) can conveniently be obtained from this one supply.

This Constant-Voltage/Current-Limiting supply is short-circuit protected by a fixed current limiting circuit which is activated at approximately 110% of rated load current. The current-limit point can be reduced by changing the value of a single internal resistor. Units may be bench operated or rack mounted individually or in pairs using accessory rack mounting hardware.

Description—Triple Output Models

6235A

This compact, low-cost, three-in-one power supply is a handy addition to the lab bench where single or multiple voltages are needed for designing and testing breadboards and prototypes. The Hewlett-Packard Model 6235A delivers three adjustable dc output voltages: 0 to +6 V at 1 A, 0 to +18 V at 0.2 A, and 0 to -18 V at 0.2 A. A single 0 to 36 volt output at 0.2 A can also be obtained by connecting across the +18 V and -18 V terminals.

The controls, meter, and binding posts are conveniently arranged on the front panel. One voltage control simultaneously adjusts the +18 V and -18 V outputs, which track one another and can be used to power operational amplifiers and other circuits requiring balanced positive and negative voltages. The supply's dual outputs have added versatility with an adjustable tracking ratio control (TRACK) that can set the negative output to a lower voltage than the positive output. Once the tracking ratio control has established a voltage ratio between the positive and negative outputs, the ratio remains constant as the +18 V voltage control is adjusted. A third control sets the 0 to +6 V output voltage.

The supply is a constant voltage/current limit type with each output voltage continuously adjustable over its range, while the maximum current available is automatically limited to prevent overloading. The power supply's outputs share a common terminal and are isolated from chassis ground so that any output terminal can be grounded if desired. Each output voltage or current can be quickly selected and monitored with the push-button meter switches.

Model 6235A measures 89 H x 157 W x 210 mm D (3.5" x 6.17" x 8.25") and weighs 2.3 kg (5 lb).

6236B and 6237B

Microprocessors, digital and linear integrated circuits, and displays used in lab development frequently require triple output power supplies for operating prototypes. The 6236B and 6237B are valued additions to the design bench due to their multiple output voltages, small size, ease of operation and application-related performance.

These compact constant-voltage/current-limiting supplies combine 0 to ± 20 V tracking outputs rated at 0.5 amps with a single output rated at 0 to +6 volts at up to 2.5 amps in the 6236B, and 0 to +18 volts at 1 amp in the 6237B.

Controls, meters, and binding posts are logically arranged on a neatly laid out front panel. One voltage control simultaneously adjusts the 20 V and -20 V outputs, which track within 1% to power operational amplifiers and circuits requiring balanced voltages. A tracking ratio control can disable the 1:1 tracking feature and set the negative output to a lower voltage than that of the positive output. Once the tracking ratio control has established a voltage ratio between the positive and negative outputs, the ratio remains constant as the ± 20 V voltage control varies both outputs. Another voltage control sets the 0 to +6 V (6236B) or 0 to +18 V (6237B) output.

All outputs are protected against overload and short-circuit damage by fixed current limiting circuits. For any overload condition, the +20 V and -20 V outputs in both models are limited to 0.55 amps and the +18 V output in the 6237B is limited to 1.1 amps. The overload protection circuit for the +6 V output in the 6236B has a current foldback characteristic that reduces the maximum available current from about 2.75 amps at a 6 V terminal voltage to 1 amp at zero volts (or short circuited). This foldback limiting characteristic maximizes the available current in the important 5 to 6-volt range while minimizing semiconductor dissipation during overloads.

Another protective feature safeguards sensitive load circuitry by preventing an output voltage overshoot when the supply is turned on or off.

Separate dual-range panel meters allow both the voltage and current of any output to be monitored simultaneously. A three-position switch selects the supply output and the proper meter ranges.

Both models measure only 89 H x 216 W x 319 mm D (3.5" x 8.5" x 12.5") and weigh 4.3 kg (9.5 lb).

POWER SUPPLIES

General Purpose: Laboratory Bench Applications
Models 6200B-6218A, 6234A-6237B & 6384A



Specifications

RATINGS		PERFORMANCE							GENERAL	
DC Output		Model	Load Effect	Source Effect	PARΔ rms/p-p	Control Mode and Resolution	Remote Control Coefficients	Power* 115 V ac ± 10%	Options*	Price
Volts	Amps									
SINGLE OUTPUT—10 WATTS										
0-10	0-1	6214A	4 mV	4 mV	200 μV/1 mV	CV/CC	NA	48-440 Hz 0.3 A, 28 W	28	\$265
0-25	0-0.4	6216A	4 mV	4 mV	200 μV/1 mV	CV/CC	NA	48-440 Hz 0.3 A, 28 W	28	\$265
0-50	0-0.2	6218A	4 mV	4 mV	200 μV/1 mV	CV/CC	NA	48-440 Hz 0.3 A, 28 W	28	\$265
0-100	0-0.1	6212A	8 mV	4 mV	200 μV/1 mV	CV/CC	NA	48-440 Hz 0.3 A, 28 W	28	\$295
SINGLE OUTPUT—UP TO 30 WATTS										
4.4-5.5	0-8	6384A	2 mV	2 mV	1 mV/5 mV	CV/CL 15 mV/NA	NA	48-63 Hz 1.4 A, 120 W	28	\$550
0-7.5	0-3	6203B	5 mV	3 mV	200 μV/1 mV	CV/CC 5 mV/2 mA	200Ω/V ± 1% 500Ω/A ± 10%	48-440 Hz 0.9 A, 70 W	9, 11, 15, 28	\$450
Dual range 0-20 or 0-40	0-1.5 0-0.75	6200B	0.01% + 4 mV	0.01% + 4 mV	200 μV/1 mV	CV/CC 10 mV/2 mA	200Ω/V ± 1% 0.5 kΩ/A ± 10% or 1 kΩ/A ± 10%	48-440 Hz 0.9 A, 70 W	9, 11, 15, 28	\$450
Dual range 0-30 or 0-60	0-1 0-0.5	6206B	0.01% + 4 mV	0.01% + 4 mV	200 μV/1 mV	CV/CL 10 mV/NA	300Ω/V ± 1% N/A	48-440 Hz 1 A, 66 W	9, 11, 15, 28	\$425
0-160	0.2	6207B	0.02% + 2 mV	0.02% + 2 mV	500 μV/40 mV	CV/CC 25 mV/500 μA	300Ω/V ± 1% 75 kΩ/A ± 10%	48-63 Hz 1 A, 60 W	9, 15, 28	\$550
0-320	0-0.1	6209B	0.02% + 2 mV	0.02% + 2 mV	1 mV/40 mV	CV/CC 40 mV/200 μA	300Ω/V ± 1% 150 kΩ/A ± 10%	48-63 Hz 1 A, 60 W	9, 15, 28	\$550
DUAL OUTPUT—10 WATTS										
Dual output 0-25 and 0-25	0.2 0.2	6234A	0.01% + 1 mV	0.01% + 1 mV	200 μV/1 mV	CV/CL	NA	104-127 Vac 47-63 Hz 0.26A, 35 W	28	\$295
OUTPUT—UP TO 30 WATTS										
Two dual ranges 0-20/0-40 and 0-20/0-40	0-0.6/0.3 0-0.6/0.3	6205C	0.01% + 4 mV	0.01% + 4 mV	200 μV/1 mV	CV/CL 10 mV/NA	200Ω/V ± 1% N/A	48-440 Hz 0.5 A, 50 W	9, 11, 15, 28 40	\$550
TRIPLE OUTPUT—10 WATTS										
Triple output 0 to 6 and 0 to 18 and 0 to -18	0-1 0-0.2 0-0.2	6235A	8 mV 10 mV 10 mV	8 mV 15 mV 15 mV	1 mV/5 mV 1 mV/5 mV 1 mV/5 mV	CV/CL CV/CL CV/CL	NA NA NA	47-63 Hz 0.26 A, 35 W	28	\$325
TRIPLE OUTPUT—UP TO 30 WATTS										
Triple output 0 to +6 and 0 to +20 and 0 to -20	1-2.5 0.5 0.5	6236B	0.01% + 2 mV	0.01% + 2 mV	350 μV/1.5 mV	CV/CL 70 mV/NA	NA	104-127 Vac 47-63 Hz 1.2 A, 112 W	100:100 Vac 220:220 Vac 240:240 Vac	\$550
Triple Output 0 to +18 and 0 to +20 and 0 to -20	1 0.5 0.5	6237B	0.01% + 2 mV	0.01% + 2 mV	350 μV/1.5 mV	CV/CL 70 mV/NA	NA	104-127 Vac 47-63 Hz 1.2 A, 112 W	100:100 Vac 220:220 Vac 240:240 Vac	\$550

*For 230 V ac ± 10% operation, order Opt 028 See page 278 for complete option descriptions.



POWER SUPPLIES

General Purpose: 25–200 W Output

Models 6224B–6299A

- Constant voltage/constant current operation
- Remote sensing and programming
- Auto-series, -parallel, & -tracking operation

- Front and rear output terminals
- Floating output—use as positive or negative source
- Bench or rack mounting

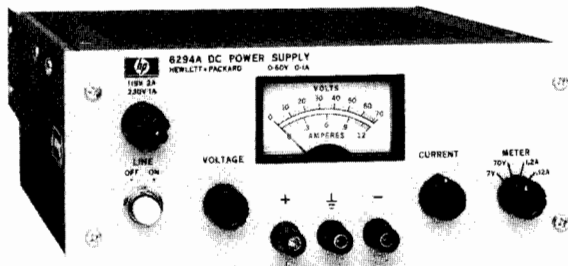

6281A, 6284A, 6289A,
6294A, 6299A

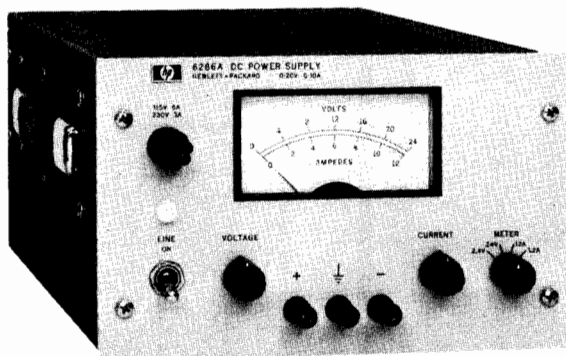

6282A, 6286A,
6291A, 6296A

Description

6281A–6299A

This series of medium-power Constant-Voltage/Constant-Current power supplies is available in two power ranges: 37–75 watts (packaged in 3½-inch high half-rack cases), and 100–200 watts (packaged in 5¼-inch high half-rack cases). All models except 6294A and 6299A have separate coarse and fine voltage and current controls that allow the voltage and current outputs to be varied from zero to the maximum rated values. The latter two models have ten-turn voltage controls. Crossover from constant-voltage to constant-current operation occurs automatically when the load current exceeds the value established by the current control settings. A four-position meter function switch selects either of two output voltage or output current ranges (X1, X0.1) for display on the panel meter.

The 37–75 watt models are of the series-regulated type. They have excellent regulation and ripple characteristics and include a special output-capacitor discharge circuit for improved programming speed. The 100–200 watt models employ a series-regulator/SCR-preregulator configuration to achieve the high efficiency necessary for a convection-cooled package of this size. They also have excellent regulation, low ripple and noise, and moderate programming speeds.

6253A and 6255A

These versatile dual-output models each contain two identical, independently-adjustable 60-watt power supplies in a full-rack width case. The regulator, voltage and current control, and metering circuits of each section of the supply are electrically identical to those of the individual 37–75 watt models described above.

Specifications

RATINGS			PERFORMANCE							
DC Output		Model	Load Effect		Source Effect		PARD (rms/p-p)		Drift (stability)	
Volts	Amps		Voltage	Current	Voltage	Current	Voltage	Current	Voltage	Current
0–7.5	0–5	6281A	5 mV	0.01% + 250 μ A	0.01% + 2 mV	0.01% + 250 μ A	200 μ V/1 mV	4 mA rms	0.1% + 2.5 mV	0.1% + 12.5 mA
0–10	0–10	6282A	0.01% + 1 mV	0.05% + 1 mA	0.01% + 1 mV	0.05% + 1 mA	500 μ V/25 mV	5 mA rms	0.1% + 2.5 mV	0.1% + 25 mA
0–20	0–3	6253A*	0.01% + 4 mV	0.01% + 250 μ A	0.02% + 2 mV	0.01% + 250 μ A	200 μ V/1 mV	2 mA rms	0.1% + 2.5 mV	0.1% + 7.5 mA
0–20	0–3	6284A	0.01% + 4 mV	0.01% + 250 μ A	0.01% + 2 mV	0.01% + 250 μ A	200 μ V/1 mV	2 mA rms	0.1% + 2.5 mV	0.1% + 7.5 mA
0–20	0–10	6286A	0.01% + 1 mV	0.05% + 1 mA	0.01% + 1 mV	0.05% + 1 mA	500 μ V/25 mV	5 mA rms	0.1% + 2.5 mV	0.1% + 25 mA
0–24	0–3	6224B	0.01% + 4 mV	0.01% + 250 μ A	0.01% + 2 mV	0.01% + 250 μ A	200 μ V/1 mV	200 μ A/1 mA	0.1% + 2.5 mV	0.1% + 7.5 mA
0–40	0–1.5	6255A*	0.01% + 2 mV	0.01% + 250 μ A	0.01% + 2 mV	0.01% + 250 μ A	200 μ V/1 mV	500 μ A rms	0.1% + 2.5 mV	0.1% + 4 mA
0–40	0–1.5	6289A	0.01% + 2 mV	0.01% + 250 μ A	0.01% + 2 mV	0.01% + 250 μ A	200 μ V/1 mV	500 μ A rms	0.1% + 2.5 mV	0.1% + 4 mA
0–40	0–5	6291A	0.01% + 1 mV	0.05% + 1 mA	0.01% + 1 mV	0.5% + 1 mA	500 μ V/25 mV	3 mA rms	0.1% + 2.5 mV	0.1% + 12.5 mA
0–50	0–1.5	6226B	0.01% + 2 mV	0.1% + 250 μ A	0.1% + 2 mV	0.01% + 250 μ A	200 μ V/1 mV	200 μ A/1 mA	0.1% + 2.5 mV	0.1% + 4 mA
0–60	0–1	6294A	0.01% + 2 mV	0.01% + 250 μ A	0.01% + 2 mV	0.01% + 250 μ A	200 μ V/1 mV	500 μ A rms	0.1% + 2.5 mV	0.1% + 2.5 mA
0–60	0–3	6296A	0.01% + 1 mV	0.5% + 1 mA	0.01% + 1 mV	0.05% + 1 mA	500 μ V/25 mV	3 mA rms	0.1% + 2.5 mV	0.1% + 7.5 mA
0–100	0–0.75	6299A	0.01% + 2 mV	0.01% + 250 μ A	0.01% + 2 mV	0.01% + 250 μ A	200 μ V/1 mV	500 μ A rms	0.1% + 2.5 mV	0.1% + 2 mA

*Models 6253A and 6255A contain two identical, independently-adjustable power supplies.



6224B, 6226B

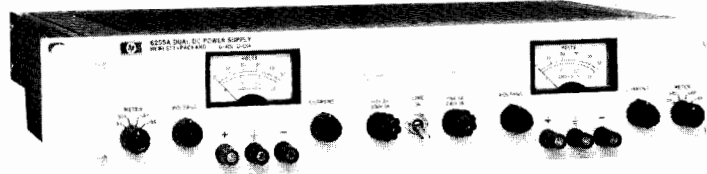

6253A, 6255A

By combining the versatility of a dual power supply with the flexibility of auto-series and auto-parallel operation, twice the maximum rated output voltage or current of each section can be obtained from the one supply. In addition, using the supply's auto-tracking capability, opposite-polarity voltages (± 20 V for Model 6253A or ± 40 V for Model 6255A) are possible.

6224B and 6226B

These Constant-Voltage/Constant-Current supplies are designed for general laboratory use. Both have excellent regulation, low ripple and noise, and high speed programming characteristics. Large easy-to-read meter scales, 10-turn voltage and current controls, and front and rear output terminals enhance ease of operation. Models 6224B and 6226B have single outputs of 0–24 V at 0–3 A and 0–50 V at 0–1.5 A, respectively.

Accessories and options

The accessories and options available for use with Models 6224B–6299A are listed on page 278.

Specifications—General

Load effect transient recovery: Time, 50 μ s. Level, 15 mV.

Meter accuracy: 3% of full scale.

Power: standard input voltage is 115 V ac $\pm 10\%$. Order option 028 for 230 V ac $\pm 10\%$ operation. Input power frequency, maximum input current, maximum power consumption are:

6224B, 48–63 Hz, 1.8 A, 164 W 6226B, 48–63 Hz, 1.8 A, 164 W;
6253A, 48–440 Hz, 2.6 A, 235 W 6255A, 48–440 Hz, 2.6 A, 235 W;
6281A, 48–440 Hz, 1.3 A, 118 W 6282A, 57–63 Hz, 3.5 A, 200 W;
6284A, 48–440 Hz, 1.5 A, 128 W 6286A, 57–63 Hz, 5.5 A, 320 W;
6289A, 48–440 Hz, 1.3 A, 110 W 6291A, 57–63 Hz, 5.5 A, 280 W;
6294A, 48–440 Hz, 1.3 A, 114 W 6296A, 57–63 Hz, 4.5 A, 250 W;
6299A, 48–440 Hz, 1.5 A, 135 W.

Size: 6224B, & 6226B: 166 H x 130 W x 294 mm D ($6\frac{1}{2}$ " x $5\frac{1}{8}$ " x $11\frac{3}{16}$ "). 6253A, 6255A: 87 H x 483 W x 403 mm D ($3\frac{3}{8}$ " x 19 " x $15\frac{7}{8}$ "). 6281A, 6284A, 6289A, 6294A, 6299A: 87 H x 209 W x 398 mm D ($3\frac{3}{16}$ " x $8\frac{7}{16}$ " x $15\frac{3}{8}$ "). 6282A, 6286A, 6291A, 6296A: 131 H x 210 W x 435 mm D ($5\frac{1}{16}$ " x $8\frac{1}{4}$ " x $17\frac{1}{8}$ ").

Temperature: operating, 0 to 55°C; storage, –40 to 75°C.

Specifications, continued

REMOTE CONTROL FEATURES								GENERAL					
Resistance Coefficient		Voltage Coefficient		Speed, UP*		Speed, DOWN*		Overvoltage		Weight		Options ^a	Price
Voltage	Current	Voltage	Current	NL	FL	NL	FL	Range	Margin	Net	Shipping		
200 Ω /V $\pm 1\%$	200 Ω /A $\pm 10\%$	1 V/V $\pm 1\%$	0.2 V/A $\pm 10\%$	1 ms	2 ms	10 ms	6 ms	2.5–10 V	4% + 2 V	6.4 kg/14 lb	7.2 kg/16 lb	9, 11, 15, 28, 40	\$575
200 Ω /V $\pm 1\%$	100 Ω /A $\pm 10\%$	1 V/V $\pm 1\%$	100 mV/A $\pm 10\%$	70 ms	200 ms	9 s	40 ms	1–13 V	7% + 1 V	11.3 kg/25 lb	13.6 kg/30 lb	5, 9, 11, 15, 28, 40	\$725
200 Ω /V $\pm 1\%$	500 Ω /A $\pm 10\%$	1 V/V $\pm 1\%$	0.33 V/A $\pm 10\%$	30 ms	80 ms	400 ms	100 ms	2.5–23 V	4% + 2 V	12.7 kg/28 lb	17.7 kg/39 lb	9, 10, 11, 15, 28, 40	\$950
200 Ω /V $\pm 1\%$	500 Ω /A $\pm 10\%$	1 V/V $\pm 1\%$	0.33 V/A $\pm 10\%$	30 ms	80 ms	400 ms	100 ms	2.5–23 V	4% + 2 V	6.4 kg/14 lb	7.2 kg/16 lb	9, 11, 15, 28, 40	\$500
200 Ω /V $\pm 1\%$	100 Ω /A $\pm 10\%$	1 V/V $\pm 1\%$	100 mV/A $\pm 10\%$	150 ms	150 ms	9 s	70 ms	2–22 V	7% + 1 V	10.8 kg/26 lb	13.1 kg/29 lb	5, 9, 11, 15, 28	\$775
200 Ω /V $\pm 1\%$	500 Ω /A $\pm 10\%$	1 V/V $\pm 1\%$	0.33 V/A $\pm 10\%$	4 ms	10 ms	50 ms	15 ms	NA	NA	7.3 kg/16 lb	9.5 kg/21 lb	15, 28, 40	\$750
200 Ω /V $\pm 1\%$	500 Ω /A $\pm 10\%$	1 V/V $\pm 1\%$	0.66 V/A $\pm 10\%$	15 ms	45 ms	200 ms	40 ms	2.5–44 V	4% + 2 V	12.7 kg/28 lb	17.7 kg/39 lb	9, 10, 11, 15, 28, 40	\$950
200 Ω /V $\pm 1\%$	500 Ω /A $\pm 10\%$	1 V/V $\pm 1\%$	0.66 V/A $\pm 10\%$	15 ms	45 ms	200 ms	40 ms	2.5–44 V	4% + 2 V	6.4 kg/14 lb	7.2 kg/16 lb	9, 11, 15, 28, 40	\$500
200 Ω /V $\pm 1\%$	200 Ω /A $\pm 10\%$	1 V/V $\pm 1\%$	200 mV/A $\pm 10\%$	275 ms	275 ms	13 s	275 ms	6–43 V	7% + 1 V	11.3 kg/25 lb	12.7 kg/28 lb	5, 9, 11, 15, 28	\$775
200 Ω /V $\pm 1\%$	500 Ω /A $\pm 10\%$	1 V/V	1 V/A	20 ms	65 ms	200 ms	50 ms	NA	NA	7.3 kg/16 lb	8.2 kg/18 lb	15, 28, 40	\$750
300 Ω /V $\pm 1\%$	1 k Ω /A $\pm 10\%$	1 V/V $\pm 1\%$	1 V/A $\pm 10\%$	25 ms	80 ms	2 s	175 ms	5–65 V	4% + 2 V	5.9 kg/13 lb	6.8 kg/15 lb	9, 11, 15, 28, 40	\$525
300 Ω /V $\pm 1\%$	500 Ω /A $\pm 10\%$	1 V/V $\pm 1\%$	333 mV/A $\pm 10\%$	600 ms	600 ms	5 s	200 ms	9–66 V	7% + 1 V	11.3 kg/25 lb	12.7 kg/28 lb	5, 9, 11, 15, 28	\$775
300 Ω /V $\pm 1\%$	1 k Ω /A $\pm 10\%$	1 V/V $\pm 1\%$	1.3 V/A $\pm 10\%$	25 ms	200 ms	1.5 s	200 ms	20–106 V	4% + 2 V	5.9 kg/13 lb	6.8 kg/15 lb	11, 15, 28, 40	\$550

^aSee page 278 for complete option and accessory descriptions.

*UP = increasing output voltage. NL = No output load current. FL = Full rated output load current.

POWER SUPPLIES

General Purpose: Autoranging—200 & 1000 W Output

Models 6012A and 6024A

- Autoranging output
- Ten-turn voltage and current controls
- Fast remote programming speed

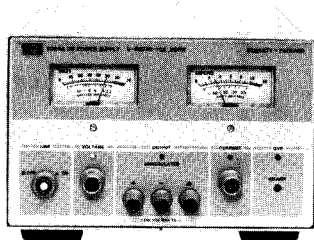

6024A—200 watts

Autoranging Power Supply Description

The model 6012A and 6024A set a new technological standard for laboratory and system dc power supplies. They are the first in a new generation of power supplies from Hewlett-Packard, combining state of the art advances in both components and circuit design. The result is increased performance and flexibility, and friendlier operation both on the bench and in automated test and control systems.

The basic difference between an autoranging power supply and conventional Constant Voltage/Constant Current (CV/CC) power supplies can be seen by comparing the output characteristics of each. A conventional CV/CC power supply can provide maximum output power at only one combination of output voltage and current. Autoranging power supplies provide maximum output power over a wide and continuous range of voltage and current combinations, without the operator having to manually select the proper output range.

Using the model 6024A as an example, you would have to combine a 20-volt 10-amp supply, a 40-volt 5-amp supply, and a 60-volt 3-amp supply in order to approximate the same capability as the 6024A. (See output curves on next page.) The extended range feature of these power supplies makes them a convenient and cost-effective unit capable of satisfying many different dc requirements.

In the Lab

Both models have many features that make them versatile. Mode indicators, adjustable overvoltage protection, 10-turn pots, amplified current monitor terminals, and voltage and current meters are some of the features. A barrier strip at the rear of the supply provides the necessary terminals for current monitoring, remote programming, and remote sensing. Auto-Parallel—Up to eight units of the same model may be connected in parallel to increase total output current capability while maintaining control from one master power supply. Auto-Series—Up to four units may be connected in series to increase total output voltage to 240V while maintaining control from one master power supply.

Several LEDs on the front panel indicate the operating status. Two of them are green and indicate whether the supply is in constant-voltage or constant-current operation. Red LEDs signal an unregulated output condition whenever the power supply exceeds its output power rating, or an overtemperature condition or ac brownout occurs. Another red LED indicates when the overvoltage protection (OVP) circuit is enabled. These indicators provide the power supply operating status without any further measurements or control changes.

Two 10-turn potentiometers on the front panel provide high resolution control of output voltage and current. Therefore the user does not have to compromise resolution at low voltages. A secondary scale on the voltmeter indicates maximum "Amperes Available". Likewise, the ammeter has a secondary scale to indicate the "Volts Available". The secondary scales are calibrated to follow the maximum output power curve and let the user know approximately how much power margin is available at any operating point.

Because of the delicate nature of many loads several types of protection have been included. When operating in constant-voltage mode, a maximum current limit can be set. Similarly, when operating in constant-current mode, a maximum compliance voltage can be set.

- Designed for system applications
- Operating mode status indicators
- High efficiency, compact and lightweight

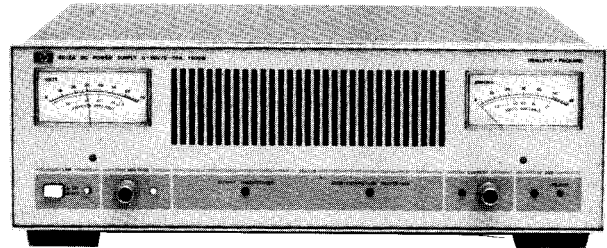

6012A—1000 watts

These supplies also feature an adjustable overvoltage protection circuit.

In the System

System designers frequently need a variety of fixed and programmable power supplies. In general, the power supply is selected by taking into consideration the existing and anticipated applications of the system. Since it is difficult to fully identify all of the system lifetime requirements, a high performance, wide voltage/current range, system compatible supply has high merit. Furthermore, by standardizing on autoranging power supplies the system designer can reduce the number of different models needed along with their consequent documentation and support requirements.

Two programming techniques are available—voltage and resistance. Either of these techniques can be used to program the output voltage or current. Both models offer fast programming speed. In a no-load, down-programming condition this active down-programming speed gives an improvement of up to 15-to-1 over a conventional power supply of similar output rating. Sensing terminals are located at the rear of the power supply for applications where the load may be some distance from the supply. When using remote sensing, the power supply maintains regulation at the load rather than at the rear terminals of the supply. The amplified current monitor feature provides a voltage referenced to the negative output terminal that is proportional to the output current.

Some of the most important benefits of using these supplies in systems result from the switching technology employed. A switching frequency of 20 kHz is used which allows most power handling components, as well as the filter capacitors, to be substantially reduced in size. This contributes to the reduced size and weight of the supply. Typical operating efficiency is 75%, which reduces the amount of cooling necessary for the overall system and enables the system to use less power.

The optional interface (Option 002) provides a convenient low-cost means of integrating the supply into a system. The interface features are available through a 37-pin connector on the back of the power supply, and include:

Remote programming: Both the output voltage and current can be remotely programmed. In addition to external voltage and resistance programming, the interface allows current programming.

Status readback: Six optically isolated status lines provide a digital output to indicate the following states: constant-voltage, constant current, unregulated output, ac line fault, overtemperature, and over-voltage.

Remote shutdown: There are two methods to remotely disable the output. The first method, utilizing two inputs, allows one input to be pulse "set" and the other to be pulse "reset." The second method uses one input whose level determines the output condition. These input lines are TTL compatible and optically isolated to prevent ground loops.

Output bias supplies: Three bias supplies are available with +5V, +15V, and -15V to power DAC's and other user supplied circuitry. **Voltage & current readback:** For convenience, both are brought through the option connector.



Specifications for model 6024A—200 watts

DC output: Voltage and current output can be adjusted over the ranges indicated by using front panel controls, analog programming, or optional system interface.

Voltage: 0–60 V **Current:** 0–10 A

Maximum available output power from 20V to 60V is indicated below.

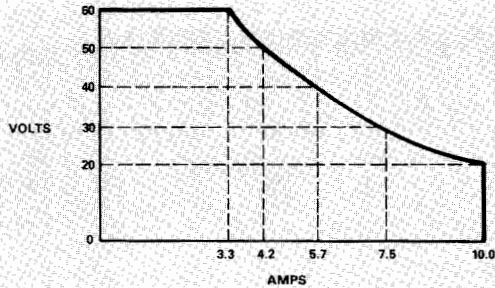

Load effect: (Load Regulation):

Voltage: 0.01% + 3 mV **Current:** 0.01% + 3 mA

Source effect:

Voltage: 0.01% + 2 mV **Current:** 0.01% + 2 mA

Pard: (Ripple and Noise) RMS/p-p, 20Hz to 20 MHz:

Voltage: 3 mV/30 mV **Current:** 5 mA RMS

Temperature coefficient: $\Delta/^\circ\text{C}$ after 30 minute warmup:

Voltage: 0.01% + 1 mV **Current:** 0.03% + 1 mA

Drift: (Stability) change in output over an 8 hour interval.

Voltage: 0.03% + 3 mV **Current:** 0.03% + 3 mA

Load transient recovery time: Less than 1 ms for output voltage recovery to within 75 mV of the nominal output following a change in output current from 90% to 100% or 100% to 90% of maximum current.

Resolution: (Minimum adjustment of front panel controls):

Voltage: 20 mV **Current:** 5.0 mA

Output impedance: Typical value is 1 m Ω in series with 30 μH .

Remote control (analog programming):

Resistance necessary for full scale output of:

Voltage: 2500 Ω **Current:** 2500 Ω

Accuracy: 0.8% + 1 mV **Accuracy:** 2.4% + 1 mA

Voltage necessary for full scale output of:

Voltage: 5 volts **Current:** 5 volts

Accuracy: 0.2% + 1 mV **Accuracy:** 0.9% + 1 mA

Programming response time: Maximum time for output voltage to change from 0V to 60V or 60V to 2V and settle within 60 mV.

Up: Full Load (18 Ω) 200 ms **Down:** Full Load (18 Ω) 300 ms
No Load 200 ms No Load 600 ms

Overvoltage protection: Trip voltage adjustable from 2 to 64 volts.

Amplified current monitor: 0-5V monitor output for 0-10 A output.

Accuracy: 0.9% + 7 mV **Output impedance:** 10 k Ω nom.

EMI specifications: Meets VDE 0871/6.78 Level A.

Safety specifications: Complies with IEC 348, VDE 0411, CSA 556B, CSA C22.2 #0-1975

Meter accuracy: $\pm 3\%$ of full scale

DC output isolation: ± 240 Vdc from ground

Temperature rating: Operating: 0 to 55 $^\circ\text{C}$.

Storage: -40 to +75 $^\circ\text{C}$. Fan Cooled

AC input: 104-127 Vac 48-63 Hz, 5.3 A RMS maximum.

System Interface Option Specifications

Remote control (analog programming):

Sink current necessary for full scale of:

Voltage: 2 mA **Current:** 2 mA

Accuracy: 0.3% + 7 mV **Accuracy:** 1% + 2 mA

Isolation: Status and control lines; 600Vdc max from equipment ground, from the power supply output or from each other.

Weight: Net 5.4 kg (12 lbs.). Shipping 7.3 kg (16 lbs.).

Ordering Information

Option	Price
6024A Power Supply	\$875
Option 002: System Interface	\$300
Option 100: 87-106 VAC, 48-63 Hz	N/C
Option 220: 191-233 VAC, 48-63 Hz	N/C
Option 240: 208-250 VAC, 48-63 Hz	N/C
Option 910: Extra Operating & Service Manual	\$10

Specifications for model 6012A—1000 watts

DC output: Voltage and current output can be adjusted over the ranges indicated by using front panel controls, analog programming, or optional system interfaces.

Voltage: 0-60 V **Current:** 0-50 A

Maximum available output power from 20V to 60V is indicated below.

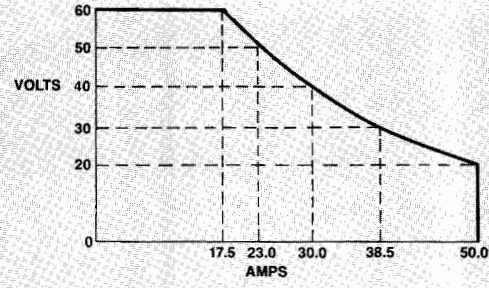

Load effect: (Load Regulation):

Voltage: 0.01% + 5 mV **Current:** 0.01% + 5 mA

Source effect:

Voltage: 0.01% + 3 mV **Current:** 0.01% + 5 mA

Pard: (Ripple and Noise) RMS/p-p, 20Hz to 20MHz:

Voltage: 5 mV/50 mV **Current:** 25 mA RMS

Temperature coefficient: $\Delta/^\circ\text{C}$ after 30 minute warmup:

Voltage: 0.01% + 2 mV **Current:** 0.01% + 3 mA

Drift: (Stability) change in output over an 8 hour interval.

Voltage: 0.03% + 5 mV **Current:** 0.03% + 5 mA

Load transient recovery time: Less than 2 ms for output voltage recovery to within 100 mV of the nominal output following a change in output current from 90% to 100% or 100% to 90% of maximum current.

Resolution: (Minimum adjustment of front panel controls):

Voltage: 20 mV **Current:** 20 mA

Output impedance: Typical value is 0.2 m Ω in series with 15 μH .

Remote control (analog programming):

Resistance necessary for full scale output of:

Voltage: 2500 Ω **Current:** 2500 Ω

Accuracy: 1% + 3 mV **Accuracy:** 2.5% + 10 mA

Voltage necessary for full scale output of:

Voltage: 5 volts **Current:** 5 volts

Accuracy: 0.3% + 3 mV **Accuracy:** 1% + 10 mA

Programming response time: Maximum time for output voltage to change from 0V to 60V or 60V to 2V and settle within 200 mV.

Up: Full Load (3.4 Ω) 120 ms **Down:** Full Load (3.4 Ω) 400 ms
No Load 120 ms No Load 1.2s

Overvoltage protection: Trip voltage adjustable from 2 to 60 volts.

Amplified current monitor: 0-5V monitor output for 0-50 A output.

Accuracy: 1% + 10 mV **Output impedance:** 10 k Ω nom.

EMI specifications: Meets VDE 0871/6.78 Level A.

Safety specifications: Complies with IEC 348, VDE 0411, CSA 556B, CSA C22.2 #0-1975

Meter accuracy: $\pm 3\%$ of full scale

DC output isolation: ± 240 Vdc from ground

Temperature rating: Operating: 0 to 50 $^\circ\text{C}$.

Storage: -40 to +75 $^\circ\text{C}$. Fan Cooled

AC input: 104-127 Vac 48-63 Hz, 24 A RMS maximum.

System Interface Option Specifications

Remote control (analog programming):

Sink current necessary for full scale of:

Voltage: 2 mA **Current:** 2 mA

Accuracy: 0.4% + 9 mV **Accuracy:** 1.1% + 15 mA

Isolation: Status and control lines; 600 Vdc max from equipment ground, from the power supply output or from each other.

Weight: Net 15 kg (33 lbs.). Shipping 16 kg (35 lbs.).

Ordering Information

Option	Price
6012A Power Supply	\$1550
Option 002: System Interface	\$300
Option 100: 90-105 VAC, 48-63 Hz	N/C
Option 220: 191-233 VAC, 48-63 Hz	N/C
Option 240: 208-250 VAC, 48-63 Hz	N/C
Option 910: Extra Operating & Service Manual	\$10

POWER SUPPLIES

General Purpose: 120–2000 W Output

Models 6259B-6274B & 895A

- Built-in overvoltage protection*
- Constant voltage/constant current operation
- Remote programming and sensing

- Remote sensing
- Auto-series, -parallel, and -tracking operation
- $\leq 50 \mu\text{sec}$ load transient recovery

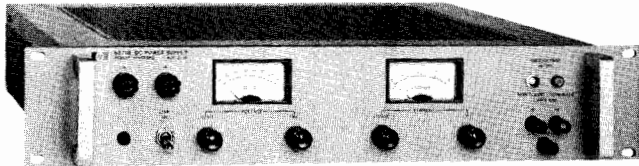

6263B, 6266B, 6271B

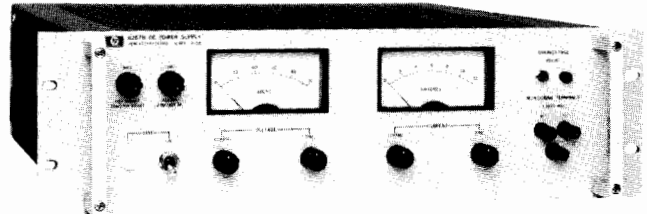

6264B, 6267B

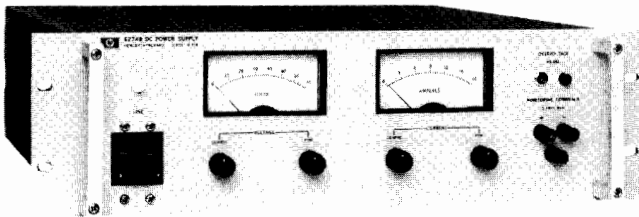

6274B

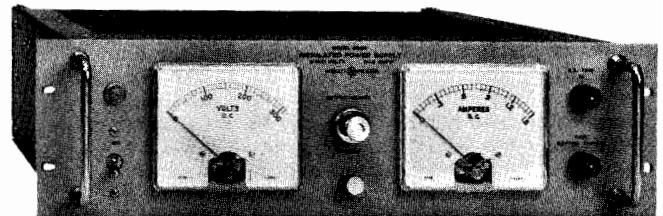

895A

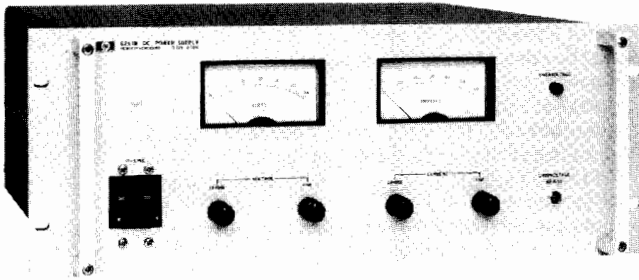

6259B, 6260B, 6261B, 6268B, 6269B

Description

Models 6259B-6274B

The series of high-performance Constant Voltage/Constant Current supplies includes twelve models with output rating from 10 to 60 V. All models employ a transistor series-regulator/triac-preregulator circuit to achieve high efficiency, excellent regulation, low ripple and noise, and moderate programming speeds in a compact full-rack width package.

Separate coarse and fine voltage and current controls allow the voltage and current outputs to be varied from zero to the maximum rated value, crossover from constant voltage to constant current operation occurs automatically when the load current exceeds the value established by the current control settings.

*These six features apply to models 6259B-6274B, but not to model 895A.

Specifications†

RATINGS			PERFORMANCE							
DC Output		Model	Load Effect		Source Effect		PAR (rms/p-p)		Drift (stability)	
Volts	Amps		Voltage	Current	Voltage	Current	Voltage	Current	Voltage	Current
0-10	0-50	6259B	0.01% + 200 μV	0.02% + 1 mA	0.01% + 200 μV	0.02% + 1 mA	500 $\mu\text{V}/5 \text{ mV}$	25 mA rms	0.03% + 2 mV	0.03% + 10 mA
0-10	0-100	6260B	0.01% + 200 μV	0.02% + 2 mA	0.01% + 200 μV	0.02% + 2 mA	500 $\mu\text{V}/5 \text{ mV}$	50 mA rms	0.03% + 2 mV	0.03% + 20 mA
0-20	0-10	6263B	0.01% + 200 μV	0.02% + 500 μA	0.01% + 200 μV	0.02% + 500 μA	200 $\mu\text{V}/10 \text{ mV}$	3 mA rms	0.03% + 500 μV	0.03% + 6 mA
0-20	0-20	6264B	0.01% + 200 μV	0.02% + 500 μA	0.01% + 200 μV	0.02% + 500 μA	200 $\mu\text{V}/10 \text{ mV}$	5 mA rms	0.03% + 500 μV	0.03% + 6 mA
0-20	0-50	6261B	0.01% + 200 μV	0.02% + 1 mA	0.01% + 200 μV	0.02% + 1 mA	500 $\mu\text{V}/5 \text{ mV}$	25 mA rms	0.03% + 2 mV	0.03% + 10 mA
0-40	0-5	6266B	0.01% + 200 μV	0.02% + 500 μA	0.01% + 200 μV	0.02% + 500 μA	200 $\mu\text{V}/10 \text{ mV}$	3 mA rms	0.03% + 500 μV	0.03% + 3 mA
0-40	0-10	6267B	0.01% + 200 μV	0.02% + 500 μA	0.01% + 200 μV	0.02% + 500 μA	200 $\mu\text{V}/10 \text{ mV}$	3 mA rms	0.03% + 2 mV	0.03% + 3 mA
0-40	0-30	6268B	0.01% + 200 μV	0.02% + 2 mA	0.01% + 200 μV	0.02% + 2 mA	1 mV/5 mV	20 mA rms	0.03% + 2 mV	0.03% + 5 mA
0-40	0-50	6269B	0.01% + 200 μV	0.02% + 2 mA	0.01% + 200 μV	0.02% + 2 mA	1 mV/5 mV	25 mA rms	0.03% + 2 mV	0.03% + 10 mA
0-60	0-3	6271B	0.01% + 200 μV	0.02% + 500 μA	0.01% + 200 μV	0.02% + 500 μA	200 $\mu\text{V}/10 \text{ mV}$	3 mA rms	0.03% + 500 μV	0.03% + 3 mA
0-60	0-15	6274B	0.01% + 200 μV	0.02% + 500 μA	0.01% + 200 μV	0.02% + 500 μA	200 $\mu\text{V}/20 \text{ mV}$	5 mA rms	0.03% + 2 mV	0.03% + 5 mA
0-320	0-1.5	895A	0.007% or 20 mV	—	0.007% or 20 mV	—	1 mV rms	—	0.1% + 5 mV	—

†Refer to page 254 for complete specification definitions.



Additional features include built-in overvoltage crowbar protection; remote error sensing; and auto-series, auto-parallel, and auto-tracking operation. The crowbar trip point adjustment and associated overvoltage indicator are conveniently located on the front panel.

Auto-series, auto-parallel, and auto-tracking connections should ordinarily include no more than three supplies. If a specific application requires the use of more than three supplies in any of the three connections, consult your local HP Field Engineer for additional information.

All dc output, ac input, sensing, control, and programming connections are made to rear-panel terminals. Either the positive or negative output terminal may be grounded or the supplies may be operated floating at up to 300 volts above ground. Models 6263B, 6264B, 6266B, 6267B, and 6271B are convection cooled. All other models in this series employ cooling fans.

Model 895A

Model 895A is a general purpose Constant-Voltage/Current-Limit supply. Output voltage is adjustable from 0-320 V via a front panel 10-turn potentiometer with concentric lock and a single-turn fine control. Separate voltage and current meters provide continuous indication of power supply outputs. High performance specifications include 0.007% line and load regulation and 1 mV rms ripple and noise. Remote sensing and programming are standard features.

Accessories and options

The accessories and options available for use with Models 6259B-6274B, 895A are listed on page 278. Special option J10 provides 220V/50 Hz operation of the model 895A only.

Specifications—General

Load effect transient recovery: time—50 μ s. Level—10 mV

Resolution: voltage control—less than 0.02%. Current control—less than 0.15%.

Temperature coefficient per °C: 0.01% of output plus 200 μ V (895A—0.03% + 1.5 mV).

Temperature ratings: operating, 0 to 55°C; Storage, -40 to 75°C.

Remote control programming: these power supplies are capable of being programmed in constant voltage and constant current operation by using an external resistance or DC voltage with coefficients as shown in the table below.

Rear terminal wiring configurations for remote control operation are specified in the operation and service manual supplied with the power supply. For remote control programming procedures and timing considerations, contact your local HP field engineer.

Power: input voltage is 115V ac or 230 V ac \pm 10%, 57-63 Hz. For other input voltage and frequency options available, see option listing below and page 278. Standard input voltage, maximum input current, and maximum power are:

6259B, 230 V ac, 6 A, 850 W†; 6260B, 230 V ac, 12 A, 1600 W†; 6261B, 230 V ac, 12 A 1500 W†; 6263B, 115 V ac, 4.5 A, 350 W*; 6264B, 115 V ac, 8 A, 600 W†; 6266B, 115 V ac, 4 A, 325 W*; 6267B, 115 V ac, 8 A, 550 W†; 6268B, 230V ac, 12 A, 1600 W†; 6269B, 230 V ac, 18 A, 2500 W†; 6271B, 115 V ac, 4 A, 300 W*; 6274B, 115 V ac, 15 A, 1200 W†; 895A, 115 V ac, 8.7 A, 585 W†.

*Three-wire, five-foot AC power cord included with power supply.

†Three-terminal barrier strip provided on power supply for AC power connections.

Size:

6263B, 6266B, 6271B: 83.7 H x 483 W x 479.4 mm D (3.296" x 19" x 18.875").

6264B, 6267B, 6274B: 127 H x 483 W x 479.4 mm D (5.00" x 19" x 18.875").

6259B, 6260B, 6261B, 6268B, 6269B: 173 H x 483 W x 479.4 mm D; (6.812" x 19" x 18.875").

895A: 128.6 H x 483 W x 463.6 mm D (5.062" x 19" x 18.25").

Typical output impedance: approximated by a resistance in series with an inductance:

6259B, 50 μ Ω , 1 μ H; 6261B, 100 μ Ω , 1 μ H; 6260B, 20 μ Ω , 1 μ H; 6264B, 200 μ Ω , 1 μ H; 6263B, 500 μ Ω , 1 μ H; 6267B, 500 μ Ω , 1 μ H; 6266B, 1 m Ω , 1 μ H; 6269B, 100 μ Ω , 1 μ H; 6268B, 200 μ Ω , 1 μ H; 6274B, 1 m Ω , 1 μ H; 6271B, 5 m Ω , 1 μ H; 895A, 40 m Ω , 16 μ H.

Specifications, continued

REMOTE CONTROL FEATURES								GENERAL					
Resistance Coeff.		Voltage Coeff.		Speed Up*		Speed Down*		Overvoltage		Weight		Options [▲]	Price
Voltage	Current	Voltage	Current	NL	FL	NL	FL	Range	Margin	Net	Shipping		
200 Ω /V \pm 1%	4 Ω /A \pm 10%	1 V/V \pm 1%	10 mV/A \pm 10%	70 ms	70 ms	200 ms	100 ms	2-12 V	5% + 2V	31.3 kg/69 lb	35.3 kg/78 lb	5, 9, 10, 15, 22, 26, 27, 40	\$1450
200 Ω /V \pm 1%	2 Ω /A \pm 10%	1 V/V \pm 1%	5 mV/A \pm 10%	70 ms	70 ms	200 ms	75 ms	2-12 V	5% + 2 V	43.9 kg/97 lb	48 kg/106 lb	5, 9, 10, 15, 16, 22, 27, 40	\$1700
200 Ω /V \pm 1%	100 Ω /A \pm 10%	1 V/V \pm 1%	50 mV/A \pm 10%	150 ms	150 ms	7 s	350 ms	2-23 V	5% + 1 V	15.4 kg/34 lb	18.6 kg/41 lb	5, 9, 10, 15, 22, 27, 28, 40	\$1025
200 Ω /V \pm 1%	10 Ω /A \pm 10%	1 V/V \pm 1%	25 mV/A \pm 10%	140 ms	140 ms	10 s	150 ms	2.5-23V	5% + 1 V	21.3 kg/47 lb	24.5 kg/54 lb	5, 9, 10, 15, 22, 27, 28, 40	\$1100
200 Ω /V \pm 1%	4 Ω /A \pm 10%	1 V/V \pm 1%	10 mV/A \pm 10%	150 ms	150 ms	250 ms	250 ms	2-23 V	5% + 2 V	35.3 kg/78 lb	39.4 kg/87 lb	5, 9, 10, 15, 22, 26, 27, 40	\$1550
200 Ω /V \pm 1%	200 Ω /A \pm 10%	1 V/V \pm 1%	100 mV/A \pm 10%	275 ms	275 ms	13 s	1.5 s	2.5-45 V	5% + 1 V	15.4 kg/34 lb	18.6 kg/41 lb	5, 9, 10, 15, 22, 27, 28, 40	\$975
200 Ω /V \pm 1%	100 Ω /A \pm 10%	1 V/V \pm 1%	50 mV/A \pm 10%	275 ms	275 ms	13 s	750 ms	2.5-45 V	5% + 1 V	17.7 kg/39 lb	20.8 kg/46 lb	5, 9, 10, 15, 22, 27, 28, 40	\$1100
200 Ω /V \pm 1%	6 Ω /A \pm 10%	1 V/V \pm 1%	16.7 mV/A \pm 10%	300 ms	300 ms	1 s	650 ms	4-45 V	5% + 1 V	34.4 kg/76 lb	38.1 kg/84 lb	5, 9, 10, 15, 22, 26, 27, 40	\$1525
200 Ω /V \pm 1%	4 Ω /A \pm 10%	1 V/V \pm 1%	10 mV/A \pm 10%	350 ms	350 ms	1 s	600 ms	4-45 V	5% + 1 V	40.3 kg/89 lb	44 kg/98 lb	5, 9, 10, 15, 22, 27, 40	\$1600
300 Ω /V \pm 1%	300 Ω /A \pm 10%	1 V/V \pm 1%	167 mV/A \pm 10%	600 ms	600 ms	7 s	2 s	6-66 V	5% + 1 V	15.4 kg/34 lb	18.6 kg/41 lb	5, 9, 10, 15, 22, 27, 28, 40	\$950
300 Ω /V \pm 1%	67 Ω /A \pm 10%	1 V/V \pm 1%	33.3 mV/A \pm 10%	600 ms	600 ms	40 s	800 ms	6-66 V	5% + 1 V	21.7 kg/48 lb	24.5 kg/54 lb	5, 9, 10, 15, 22, 27, 28, 40	\$1250
300 Ω /V	—	—	—	—	—	—	—	NA	NA	22.6 kg/50 lb	29.4 kg/65 lb	J10	\$1550

*Up = increasing output voltage. NL = No output load current. FL = Full rated output load current

▲See page 278 for complete option and accessory descriptions. 895A-J10 is a special option for 220V/50Hz operation



POWER SUPPLIES

General Purpose: 300—11,000 W Output

Models 6428B—6483C

- Outstanding value—low cost/watt
- Up to 75% efficiency at full output
- Constant voltage/current operation

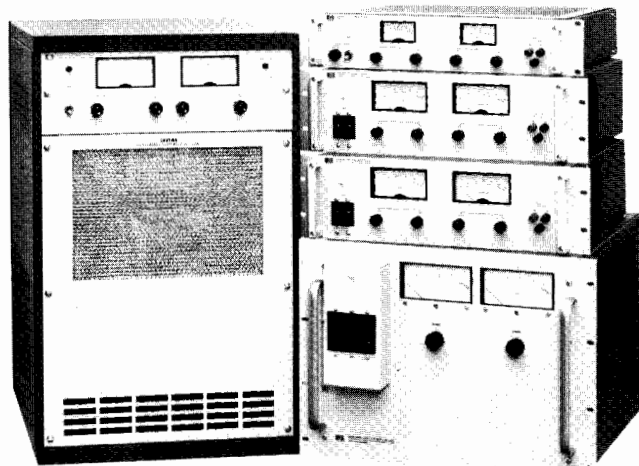

6428B—6483C

Description

This series of SCR-regulated power supplies is designed for high-power applications requiring a fixed or variable DC source with moderate regulation and ripple. For supplies with better regulation, faster response time, and lower ripple, see models 6259B—6274B and 895A, on page 262.

Operating Features

All supplies in this series are of the Constant-Voltage/Constant-Current type. Large easy-to-read panel meters continuously monitor output voltage current.

Specifications†

RATINGS			PERFORMANCE						
DC Output		Model	Load Effect		Source Effect		PAR Δ rms/p-p	Temperature Coefficient	Drift
Volts§	Amps§		Voltage	Current	Voltage	Current			
0-8	0-1000	6464C	0.05% + 5 mV	0.1% + 1 A	0.05% + 5 mV	0.1% + 1A	80 mV/1V	0.03% + 100 μV	0.03% + 1 mV
0-15	0-200	6453A	0.2% + 10 mV††	1% or 2A††	0.2% + 10 mV††	1% or 2A††	150 mV rms	0.05% + 2 mV	0.25% + 10 mV
0-16 or 18	0-600 or 500*	6466C	0.05% + 5mV	0.1% + 0.6 A	0.05% + 5 mV	0.1% + 0.6 A	180 mV/1V	0.03% + 200 μV	0.2% + 1 mV
0-20	0-45	6428B	40 mV	450 mA	20 mV	450 mA	40 mV/500 mV	0.05% + 5 mV	0.15% + 15 mV
0-36	0-10	6433B	36 mV	100 mA	18 mV	100 mA	36 mV/400 mV	0.03% + 5 mV	0.1% + 15 mV
0-36	0-100	6456B	0.2% + 10 mV††	1% or 1 A††	0.2% + 10 mV††	1% or 1 A††	180 mV rms	0.05% + 2 mV	0.25% + 10 mV
0-36	0-300	6469C	0.05% + 5 mV	0.1% + 0.3 A	0.05% + 5 mV	0.1% + 0.3A	180 mV/1 V	0.03% + 400 μV	0.15% + 1 mV
0-40	0-25	6434B	40 mV	200 mA	18 mV	200 mA	40 mV/500 mV	0.03% + 5 mV	0.1% + 20 mV
0-60	0-5	6438B	60 mV	50 mA	30 mV	50 mA	120 mV/400 mV	0.03% + 10 mV	0.1% + 30 mV
0-60	0-15	6439B	120 mV	150 mA	60 mV	150 mA	60 mV/500 mV	0.03% + 10 mV	0.1% + 30 mV
0-64	0-50	6459A	0.2% + 10 mV††	1% or 0.5 A††	0.2% + 10 mV††	1% or 0.5 A††	160 mV rms	0.05% + 2 mV	0.25% + 10 mV
0-64	0-150	6472C	0.05% + 100 mV	0.1% + 0.15 A	0.05% + 100 mV	0.1% + 0.15 A	160 mV/2V	0.03% + 4 mV	0.15% + 16 mV
0-110	0-100	6475C	0.05% + 100 mV	0.1% + 0.1 A	0.05% + 100 mV	0.1% + 0.1 A	200 mV/2 V	0.03% + 5 mV	0.15% + 20 mV
0-120	0-2.5	6443B	120 mV	25 mA	60 mV	25 mA	240 mV/400 mV	0.03% + 20 mV	0.1% + 60 mV
0-220	0-50	6477C	0.05% + 100 mV	0.1% + 50 mA	0.05% + 100 mV	0.1% + 50 mA	330 mV/2 V	0.03% + 8 mV	0.15% + 35 mV
0-300	0-35	6479C	0.05% + 100 mV	0.1% + 35 mA	0.05% + 100 mV	0.1% + 35 mA	330 mV/3 V	0.03% + 11 mV	0.15% + 45 mV
0-440, 500 or 600	0-25, 20, 15*	6483C	0.05% + 100 mV	0.1% + 35 mA	0.5% + 100 mV	0.1% + 35 mA	600 mV/5 V	0.03% + 20 mV	0.15% + 80 mV
1-600	5 mA-1.5 A	6448B	1 V	40 mA	600 mV	15 mA	600 mV/2 V	0.03% + 100 mV	0.1% + 300 mV

†Refer to page 254 for complete specification definitions.

††Specified for combined line and load regulation.

Δ For operation with a 50 Hz input (possible only with Option 005), the rms ripple and transient response specifications are increased by 50%.

* The output current rating is given in the same order corresponding with the voltage rating.

Input and output power, remote sensing, remote programming, and auto-series, -parallel, and -tracking connections are made to bus bars and terminal blocks on the rear panel.

Protective Features

In addition to the overload protection inherent in Constant voltage/Constant Current operation, there are many other built-in protective features included in these supplies. The features vary within the three model classifications as follows:

6428B—6448B: (1) Reverse voltage protection. (2) Fused AC input.

6453A, 6456B, 6459A: (1) AC line loss protection circuit monitors 3-phase input and cuts off SCR's and opens output bus if a phase drops out; operation resumes when AC input returns to normal. (2) 3-phase input circuit breaker. (3) Optional internal crowbar (Option 006) protects load from overvoltage condition.

6464C—6483C: (1) High-temperature protection thermostat opens input to power transformer and lights front panel indicator if supply overheats. (2) Prolonged overload protection circuit is activated and lights front panel indicator if output current exceeds approximately 115% of maximum rating. (3) Optional internal crowbar (except on 6464C) protects load from overvoltage condition. (4) Turn-on circuit limits peak line current during start-up into low impedance loads. (5) Phase-balance circuit permits operation with line-to-line input voltage imbalance up to 8%. (6) Overcurrent and overvoltage circuits of master slave supplies used in auto-series, -parallel, or -tracking operation can be interlocked.

Auto-Series, -Parallel, -Tracking Operation

Supplies may be connected in auto-series, or auto-tracking. (Except 6448B and 6483C, which cannot be connected in auto-series.)

Up to three lower power models (6428B—6448B) may be connected in any of the above configurations. Higher-power model (6453A/6483C) interconnection should ordinarily include no more than two supplies.

Remote Sensing

Remote sensing permits regulation at the load connection, rather than at the output terminals of the power supply. In all cases, there are limits to the permissible load-lead voltage drops, as follows:

Models 6428B—6448B: 2 volts in negative output lead.

Models 6453A, 6456B, 6459A: 1 volt in negative output lead.

Models 6464C—6483C: 3 volts in negative output lead.

§ Under light loading conditions, power supply may not meet all published specifications. The graph on the next page defines the permissible operating regions for CV and CC modes of operation.

For operation with a 50 Hz input (possible only with Option 05), output current is linearly derated from 100% at 40°C to 80% at 50°C.

POWER SUPPLY OUTPUT RESTRICTIONS AS A FUNCTION OF LOADING

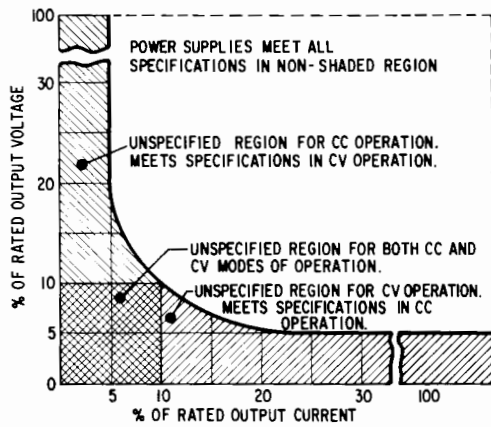

Remote Programming

The voltage and current outputs of the supplies can be programmed by a remote resistance, or, for most models, a remote voltage source. Programming speeds and coefficients are detailed in the specifications table.

AC Power Requirements

The AC power requirements vary with the three model classifications (see option listings). When powered from a 50 Hz source (possible with Option 005), the rms ripple and transient response specifications increase by 50%. The p-p ripple specification is unchanged by line frequency.

Size

Models 6433B, 6438B and 6443B: 89 H x 483 W x 445 mm D (3.5" x 19" x 17.5").

Models 6428B, 6434B, 6439B, & 6448B: 133 H x 483 W x 432 mm D (5.25" x 19" x 17").

Models 6453A, 6456B, & 6459A: 356 H x 483 W x 500 mm D (14" x 19" x 19.7").

Models 6464C, 6466C, 6469C, 6472C, 6475C, 6477C, 6479C, & 6483C: 705 H x 483 W x 715 mm D (27.75" x 19" x 28.12").

Options: see page 278 for complete options and accessory description.

Price

**AC, input power
6428B-6448B**

- Std:** 115 V ac, ±10%, single phase, 57-63 Hz N/C
- 027:** 208 V ac, ±10%, single phase, 57-63 Hz N/C
- 028:** 230 V ac, ±10%, single phase, 57-63 Hz N/C
- 005:** realignment for 50 Hz operation N/C

6453A, 6456B, 6459A: AC input connections are by means of a 4-conductor connector at rear of unit. A matching Hubbell No. 7413G plug (HP part number 1251-1570) is furnished.

- 001:** 208 V ac, ±10%, 3-phase, 15.5 A/phase, 57-63 Hz N/C
- 002:** 230 V ac, ±10%, 3-phase, 14 A/phase, 57-63 Hz N/C
- 031:** 380 V ac, ±10%, 3-phase, 8.5 A/phase, 57-63 Hz add \$100
- 032:** 400 V ac, ±10%, 3-phase, 8.0 A/phase, 57-63 Hz add \$100
- 003:** 460 V ac, ±10%, 3-phase, 7 A/phase, 57-63 Hz \$100
- 005:** realignment for 50 Hz operation N/C

6464C-6483C: AC input connections are by means of enclosed 4-wire terminal block.

- 001:** 208 V ac, ±10%, 3-phase, 55 A/phase, 57-63 Hz N/C
- 002:** 230 V ac, ±10%, 3-phase, 50 A/phase, 57-63 Hz N/C
- 031:** 380 V ac, ±10%, 3-phase, 30 A/phase, 57-63 Hz add \$250
- 032:** 400 V ac, ±10%, 3-phase, 28.5 A/phase, 57-63 Hz add \$250
- 003:** 460 V ac, ±10%, 3-phase, 25 A/phase, 57-63 Hz add \$250
- 005:** realignment for 50 Hz operation N/C

006: internal overvoltage protection crowbar

- 6459A, 6477C, 6479C, 6483C add \$345
- 6453A, 6456B add \$395
- 6472C, 6475C add \$460
- 6469C add \$510
- 6466C add \$570

14545A: casters for 6464C-6483C—set of four

\$85

Specifications, continued

REMOTE CONTROL											GENERAL			
Resolution		Load Transient Recovery Δ	Resistance Coefficient		Voltage Coefficient		Up		Down		Net Weight		Options Δ	Price
			Voltage	Current	Voltage	Current	NL	FL	NL	FL	Kg	lb		
V	C													
8 mV	1 A	100 ms, 500 mV	200 Ω /V \pm 2%	1 Ω /A \pm 2%	1 V/V \pm 1%	6.2 mV/A \pm 7%	1.6 s	0.6 s	6 s	0.1 s	235	518	1, 2, 3, 5, 23, 31, 32, 40	\$7100
65 mV	1 A	50 ms, 150 mV	200 Ω /V \pm 2%	1 Ω /A	0.4 V/V	30 mV/A	1 s	0.5 s	20 s	0.2 s	108	238	1, 2, 3, 5, 6, 10, 31, 32	\$3200
18 mV	0.5 A	100 ms, 500 mV	200 Ω /V \pm 2%	1.66 Ω /A \pm 2%	1 V/V \pm 1%	10.3 mV/A \pm 7%	1.6 s	0.6 s	15 s	0.2 s	226	500	1, 2, 3, 5, 6, 23, 31, 32, 40	\$6300
10 mV	22.5 mA	200 ms, 200 mV	200 Ω /V \pm 2%	6 Ω /A	1 V/V	**	0.2 s	0.7 s	65 s	0.7 s	30.4	67	5, 10, 27, 28	\$1500
9 mV	5 mA	200 ms, 200 mV	200 Ω /V \pm 2%	30 Ω /A	1 V/V	**	0.3 s	1.4 s	110 s	1.4 s	14.9	33	5, 10, 27, 28	\$1050
90 mV	0.5 A	50 ms, 300 mV	200 Ω /V \pm 2%	2 Ω /A	166 mV/V	60 mV/A	1 s	0.5 s	60 s	0.5 s	108	238	1, 2, 3, 5, 6, 10, 31, 32	\$3000
36 mV	0.3 A	100 ms, 500 mV	200 Ω /V \pm 2%	3.33 Ω /A \pm 2%	1 V/V	20.6 mV/A \pm 7%	1.6 s	3 s	20 s	0.5 s	226	500	1, 2, 3, 5, 6, 23, 31, 32, 40	\$6300
10 mV	12.5 mA	200 ms, 200 mV	200 Ω /V \pm 2%	12 Ω /A	1 V/V	**	0.3 s	1.2 s	75 s	1.2 s	30.4	67	5, 10, 27, 28	\$1400
9 mV	2.5 mA	200 ms, 300 mV	300 Ω /V \pm 2%	60 Ω /A	1 V/V	**	0.5 s	2.5 s	200 s	2.5 s	14	31	5, 10, 27, 28	\$1000
9 mV	7.5 mA	200 ms, 600 mV	300 Ω /V \pm 2%	20 Ω /A	1 V/V	**	0.3 s	1.3 s	75 s	1.3 s	27.6	61	5, 10, 27, 28	\$1400
100 mV	0.25 A	50 ms, 600 mV	300 Ω /V \pm 2%	4 Ω /A	94 mV/V	120 mV/A	1 s	0.5 s	45 s	0.7 s	108	238	1, 2, 3, 5, 6, 10, 31, 32	\$3000
64 mV	0.15 mA	100 ms, 750 mV	300 Ω /V \pm 2%	6.7 Ω /A \pm 2%	1 V/V \pm 3%	41.2 mV/A \pm 7%	1.4 s	2.5 s	55 s	0.7 s	226	500	1, 2, 3, 5, 6, 23, 31, 32, 40	\$6300
22 mV	0.1 A	100 ms, 1 V	300 Ω /V \pm 2%	10 Ω /A \pm 2%	1 V/V \pm 3%	62 mV/A \pm 7%	1.5 s	2 s	80 s	0.7 s	226	500	1, 2, 3, 5, 6, 23, 31, 32	\$6300
30 mV	1.3 mA	200 ms, 600 mV	300 Ω /A \pm 2%	120 Ω /A	1 V/V	**	0.5 s	2 s	210 s	2 s	14	31	5, 10, 27, 28	\$1025
44 mV	50 mA	100 ms, 2 V	300 Ω /V \pm 2%	20 Ω /V \pm 2%	1 V/V \pm 3%	124 mV/A \pm 7%	1.5 s	2 s	95 s	1 s	226	500	1, 2, 3, 5, 6, 23, 31, 32	\$6300
60 mV	35 mA	100 ms, 3 V	300 Ω /V \pm 2%	28.6 Ω /A \pm 2%	1 V/V \pm 3%	177 mV/A \pm 7%	1.5 s	2 s	75 s	1.6 s	226	500	1, 2, 3, 5, 6, 23, 31, 32	\$6300
60 mV	25 mA	100 ms, 5 V	300 Ω /V \pm 2%	40 Ω /A \pm 2%	1 V/V \pm 3%	0.25 V/A \pm 7%	1.5 s	2 s	120 s	2 s	226	500	1, 2, 3, 5, 6, 23, 31, 32	\$6600
60 mV	0.75 mA	200 ms, 3 V	300 Ω /V \pm 2%	600 Ω /A	1 V/V	**	0.2 s	1 s	45 s	2 s	27.6	61	5, 10, 27, 28	\$1350

Δ For operation with a 50 Hz input (possible only with Option 005), the rms ripple and transient response specifications are increased by 50%.

Δ See page 278 for complete option and accessory descriptions. **This feature is not available.



POWER SUPPLIES

200 Watt System Power Supply

Model 6034A

- HP-IB programming of voltage, current and OVP
- HP-IB measurement of voltage and current
- Read back of status information

- Autoranging output
- Programmable "soft" limits
- Self-Test and diagnostics

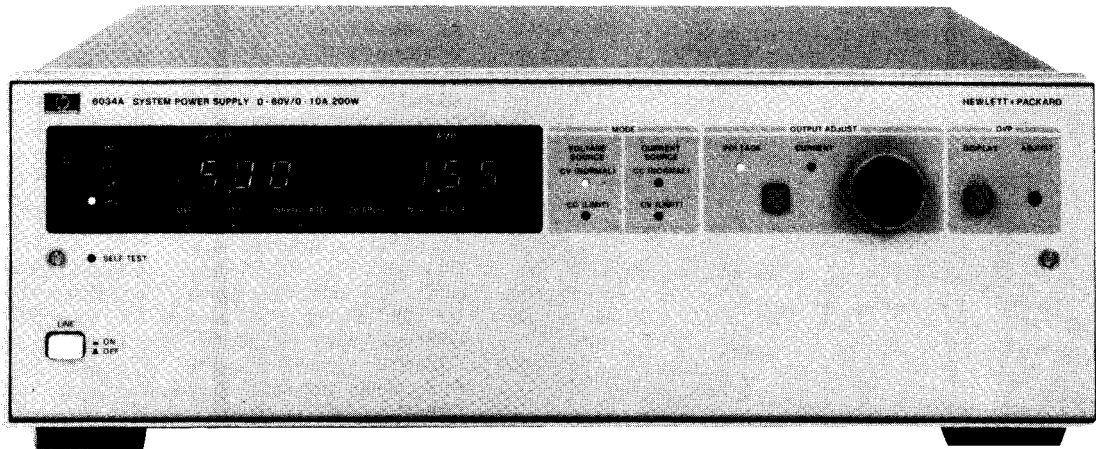

Description

The 6034A DC power supply has a combination of features and specifications that characterize it as a **Comprehensive Solution** to HP-IB system power supply applications. The 6034A combines FET switching technology with an internal microprocessor-based HP-IB programmer to yield the first bidirectional programmable autoranging DC power supply.

Consider these features when selecting your next system power supply. FET switching technology provides you with laboratory-grade performance specifications and autoranging capability in a compact lightweight package. The high electrical efficiency, obtained through the use of flyback switching, reduces your overall system cooling requirements. The microprocessor-based HP-IB interface provides you with a friendly programming format. Output voltage and current can be programmed directly in volts and amperes with 12-bit resolution. Information regarding the output and load is available through remote metering over the HP-IB. The output voltage is monitored through the voltage sensing leads of the power supply, thus the actual voltage across the load is measured. Current measurements are taken using the power supply's internal precision shunt resistor. Remote metering of voltage and current is provided with 15 mV and 2.5 mA resolution respectively. Eight status parameters can be read back via the HP-IB to enhance your system versatility.

These status parameters permit identification of the operational mode and fault conditions of the 6034A. They also can be used to initiate corrective action for fault conditions without operator intervention. The overvoltage trip point can be programmed directly in volts with 8-bit resolution.

This combination of programming, metering, and status monitoring features can significantly reduce the hardware and software necessary to construct your next automated test system.

Autoranging

The basic difference between an autoranging power supply and conventional Constant Voltage/Constant Current (CV/CC) power supplies can be seen by comparing the output characteristics of each. A conventional CV/CC power supply can provide maximum output power at only one combination of output voltage and current. The 6034A autoranging power supply provides maximum output power over a wide and continuous range of voltage and current combinations, without the operator having to program the proper output range.

You would have to combine a 20-volt 10-amp supply, a 40-volt 5-amp supply, and a 60-volt 3-amp supply in order to approximate the

same output capability as the 6034A. The extended range of the 6034A makes it a convenient and cost-effective unit capable of satisfying many different systems DC power supply requirements.

Switching Technology

Many of the important benefits of the 6034A system power supply are derived from the use of FET switching technology. This power supply operates in flyback mode at a switching frequency of 20 kHz. The inductive flyback switching topology provides the 6034A with its autoranging output characteristic and its high electrical efficiency. The 20 kHz switching frequency allows most power handling components as well as the filter capacitors, to be substantially reduced in size, thus decreasing the volume and weight of the 6034A.

Protection

Because of the delicate nature of many loads, several levels of output protection have been included in the 6034A. When operating in the constant voltage mode, a maximum output current can also be programmed. Similarly, when operating in the constant current mode, a maximum output voltage can be programmed. "Soft" voltage and current limits can also be programmed into the 6034A. If an output command is sent which is greater than the pre-programmed "soft" limit, an error is indicated and a service request may be initiated by the 6034A. The output would not change in this case.

If an overtemperature condition occurs, the power supply will be disabled, a front panel LED will indicate the condition and a service request can be transmitted over the HP-IB. In that case, a serial poll can be performed by the controller, revealing the status of the offending power supply, allowing the controller to react to the situation.

If the power supply load is sensitive to overvoltages, as most semi-conductors are, overvoltage protection is desirable. The 6034A has a front panel "hard" adjustment potentiometer used to set the trip point. The overvoltage trip point can also be programmed through the HP-IB. The output voltage at which the overvoltage protection circuit will trip is the lower of the two settings. The trip point can be displayed via a second functional level of the voltage digital panel meter (DPM). If an overvoltage condition occurs, the power supply will downprogram the output circuit, a front panel LED will indicate the condition and a service request can be initiated by the 6034A over the HP-IB. The overvoltage status of the power supply can be revealed to the controller by a serial poll of the instruments on the HP-IB. Reset can then be initiated by the controller, and the power supply will return to normal operation, if the overvoltage condition has also been cleared.

Specifications

All performance specifications are measured at the rear terminals with a resistive load and at 25°C ± 5°C.

DC Output: Voltage and current output can be programmed with the HP-1B or the front panel control over the following ranges:

Voltage: 0-60 V **Current:** 0-10 A

Maximum available output power from 20 V to 60 V is indicated below.

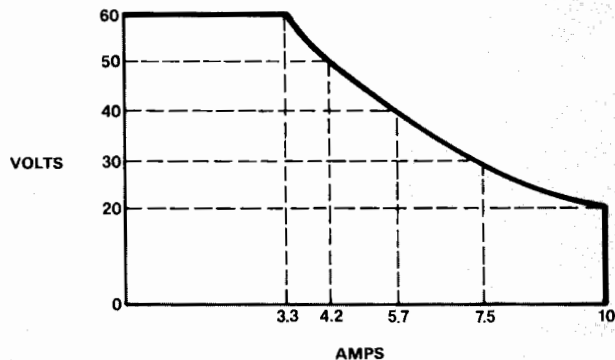

Load Effect: (Load Regulation):

Voltage: ± 0.01% ± 3 mV **Current:** 0.01% ± 3 mA

Source effect:

Voltage: 0.01% ± 2 mV **Current:** 0.01% ± 2 mA

PARD: (Ripple and Noise) RMS/p-p, 20 Hz to 20 MHz:

Voltage: 3 mV/30 mV **Current:** 5 mA RMS

Temperature coefficient: Δ/°C after 30 minute warmup:

Voltage: ± 0.009% ± 0.7 mV **Current:** ± 0.009% ± 0.8 mA

Load transient recovery time: Less than 1 ms is required for output voltage recovery (in constant voltage operation) to within 75 mV of the nominal output following a change in output current from 90% to 100% or 100% to 90% of maximum current.

Programming resolution:

Voltage: 15 mV **Current:** 2.5 mA

Programming settability:

Voltage: 30 mV **Current:** 5.0 mA

Programming accuracy (25 ± 5°C):

Constant Voltage: ± 0.07% ± 28 mV

Constant Current: ± 0.085 ± 12.5 mA

Output impedance: Typical value is 1 mΩ in series with 30 μH, but less than 1 Ω for all frequencies less than 1 MHz.

Drift: (Stability) change in output over an 8 hour interval with fixed conditions after 30 minute warmup.

Voltage: ± 0.03% ± 3 mV **Current:** ± 0.03% ± 3 mA

Programmable time delay:

Range: 0-65,535 ms

Resolution: 1 ms

Accuracy: ± 5% nominal

Amplified current monitor: Scale Factor 0-5 V monitor output for 0-10 A output current:

Accuracy: 0.1% ± 7 mV typical

Output impedance: 10 kΩ nominal

RFI Specifications: Meets VDE 0871/6.78 Level A

Programming response time: Maximum time for output voltage to change from 0 V to 60 V or 60 V to 2 V and settle within a 60 mV band (0.1% of maximum rated output):

	Band:	60 mV(*)		15 mV(**)	
		(18 Ω)	200 ms	225 ms	225 ms
Up:	Full Load	(18 Ω)	200 ms	225 ms	225 ms
	No Load		200 ms	225 ms	225 ms
Down:	Full Load	(18 Ω)	300 ms	450 ms	450 ms
	No Load		600 ms	750 ms	750 ms

*Max, ** (Typical)

Front panel meters:

Output Voltage: Low Range: ± 20.00 V

High Range: ± 200.0 V

Range switch points: Up: above 19.99 V ± 0 V
Down: below 17.5 V nominal

Resolution: Low Range: 10 mV

High Range: 100 mV

Accuracy: Low Range: ± 20 mV ± 0.07%

High Range: ± 200 mV ± 0.09%

Temperature coefficient: ± .01%/°C

Output current:

Range: ± 19.99 A

Resolution: 10 mA

Accuracy: ± 17 mA ± 0.1%

Temperature coefficient: ± 0.01%/°C ± 0.7 mA/°C

OVP Setting: (with reference to A2, not to -S)

Range: 200.0 V

Resolution: 100 mV

Accuracy: 0.5% + 150 mV (at 0.0 A load current)

Remote Meters:

Output voltage:

Range: 0-60 V

Resolution: 15 mV

Accuracy: ± 0.08% ± 35 mV

Temperature coefficient: ± 0.007%/°C ± 0.35 mV/°C

Output current:

Range: 0-10 A

Resolution: 2.5 mA

Accuracy: ± 0.125% ± 8.5 mA

Temperature Coefficient: ± 0.006%/°C ± 0.6 mA/°C

Settling time: < 200 ms

Overvoltage protection:

Local OVP adjustment: The lower of the two OVP trip points will dominate.

Range: 1.7 V to 64.5 V

Resolution: 0.2 V

Remote OVP adjustment:

Range: 2.0 V to 64.5 V (the OVP trip point = 2 V + 1.04 × soft voltage limit)

Resolution: 0.25 V

Accuracy: ± 0.7 V. The OVP circuit will trip when the voltage between the + output and the outboard side of the current monitoring resistor equals the set voltage. This could be as much as 1.35 V above the voltage between the ±S terminals.

Temperature coefficient: 250 PPM/°C

DC Output Isolation: ± 240 Vdc from ground.

Temperature rating: Operating 0-55°C

Storage: -40 to 75°C, Fan cooled

AC Input: 87 to 106 VAC Option 100

104 to 127 VAC Option 120

191 to 233 VAC Option 220

208 to 250 VAC Option 240

All are 48 to 63 Hz

(Two internal switches and one internal jumper permit line voltage selection except for Option 100)

325 watts @ 200 watts output

600 VA @ 200 watts output

Weight: Net 9.9 kg (20 lbs) Shipping: 10.4 kg (23 lbs)

Ordering Information

6034A System Power Supply

Opt 100 (100 VAC input, Max 50 V, 150 W output)

Opt 100, 120, 220 and 240

Opt 907: Front Handle Kit (Part No. 5061-0089)

Opt 908: Rack Flange Kit (Part No. 5061-0077)

Opt 909: Opt. 907, 908 combined (Part No. 5061-0083)

Opt 910: Additional Operating and Service Manual

Price

6034A System Power Supply \$2,700

Opt 100 N/C

Opt 100, 120, 220 and 240 N/C

Opt 907 \$32

Opt 908 \$25

Opt 909 \$55

Opt 910 \$15



POWER SUPPLIES

Digital Programmable 200 Watt, Autoranging

Model 6002A

- 200-watt autoranging dc output
- Constant-voltage/constant-current operation
- HP-IB programming option
- Built-in overvoltage protection crowbar
- CV/CC operating status indicators
- Remote analog programming and sensing

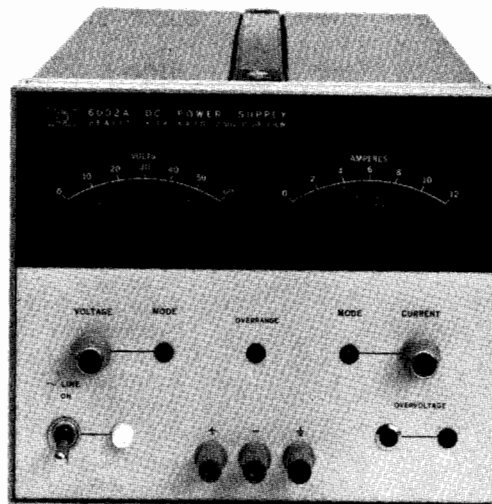

6002A

Description

The Model 6002A offers a new level of performance and usefulness in laboratory power supplies. It employs a unique regulation control concept that automatically yields a continuous span of voltage and current ratings within the basic 200-watt power rating boundary. This is beneficial in that more current is available at lower voltages, and higher voltages are available at a given current level than can be obtained from conventional 200-watt supplies.

Conventional 200-watt power supplies, rated for 50 volts or 20 volts can operate only within the shaded regions shown in Figure 1. The 6002A not only provides the outputs of the two conventional supplies, but also delivers the extra output capability shown between 20 and 50 volts.

Autoranging Output Characteristic

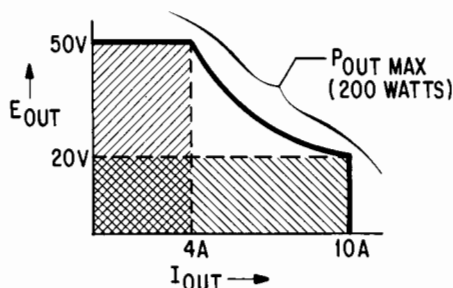

This "autoranging" capability of the 6002A provides the user with a single power supply that can cover a wide variety of applications in the lab or as a system component without his having to overspecify both the output voltage and current.

System features/remote control

Analog programming of output voltages and current can be accomplished through the use of remotely controlled resistance or voltage applied to rear panel terminals. Additional control terminals are provided for remote load voltage sensing, auto-series or parallel operation, and for remotely activating the crowbar circuit. A pulse output from the crowbar terminal indicates the overvoltage circuit has been self-activated. A voltage step change appearing on terminal indicates a changeover to or from constant-current operation.

HP-IB option

Digital programming via Opt 001 permits control of output voltage or current by the Hewlett-Packard Interface Bus (HP-IB). Two programmable ranges allow better resolution below 10 volts or 2 amps. The selection of HP-IB control of either voltage or current is done by rear panel switches.

Specifications

DC output: voltage and current output can be adjusted over the ranges indicated by front panel controls, analog programming, or an optional HP-IB interface.

Voltage: 0–50 V. **Current:** 0–10 A.

Maximum 200 Watts output from 20 V to 50 V.

Load effect: Constant-voltage, 0.01% +1 mV. Constant-current, 0.01% +1 mA.

Source effect: CV, 0.01% +1 mV; CC, 0.01% +1 mA.

PARD (ripple and noise): rms/p-p, 20 Hz to 20 MHz; CV, 1 mV/10 mV; CC, 5 mA rms.

Temperature coefficient: CV, 0.02% +200 μ V/°C; CC 0.02% +5 mA/°C.

Drift: CV, 0.05% +1 mV/8 hrs; CC, 0.05% +5 mA/8 hrs.

Resolution: front panel controls; CV, 10 mV; CC, 10 mA.

Output impedance: approximately 0.5 Ω in series with 1 μ H.

Load transient recovery: 100 μ s for output voltage to recover within 15 mV or nominal voltage setting following a load current change of 50% to 100% or 100% to 50% of full load current.

Remote control coefficients:

Resistance programming: CV, 1 k Ω /V \pm 7%. CC, 100 Ω /A \pm 7%.

Voltage programming: CV 1 V/V \pm 20 mV. CC, 50 mV/A \pm 10%.

Response time: maximum time for output voltage to change between 0 to 99.9% or 100% to 0.1% of maximum rated output voltage. Up Programming: no load, 100 ms; full load, 100 ms. Down - Programming: no load, 400 ms; full load, 200 ms.

Overvoltage protection: trip voltage adjustable from 2.5 V to 60 V.

DC output isolation: 150 V dc.

Power: 100, 120, 220, or 240 V ac (–13%, +6%), 48–63 Hz.

Temperature rating: 0°C to 55°C operating, –40°C to +75°C storage. Supply is cooled by built-in fan.

Size: 180 H x 212 W x 422 mm D (6.97" x 8.36" x 16.6").

Weight: net, 14.5 kg (32 lb). Shipping, 15.9 kg (35 lb).

HP-IB Option

Programmable ranges: high: 0–50 V or 0–10 A,
low: 0–10 V or 0–2 A.

Programming speed: same as response time.

Accuracy: Hi range: CV, 0.2% +25 mV; CC, 0.2% +25 mA.
Lo range: CV, 0.2% +10 mV; CC, 0.2% +25 mA.

Resolution: Hi range: CV, 50 mV; CC, 10 mA.
Lo range: CV, 10 mV; CC, 2 mA.

Isolation: 250 Volts dc from bus data lines to power supply.

Options

001: HP-IB Interface

6002A Autoranging DC Power Supply

Price
add \$550

\$1425



- HP-IB power supply control
- HP-IB-to-power-supply isolation
- Programmable range

- Programmable 10-volt DC output
- Unipolar/Bipolar operation
- Fast digital to analog conversion

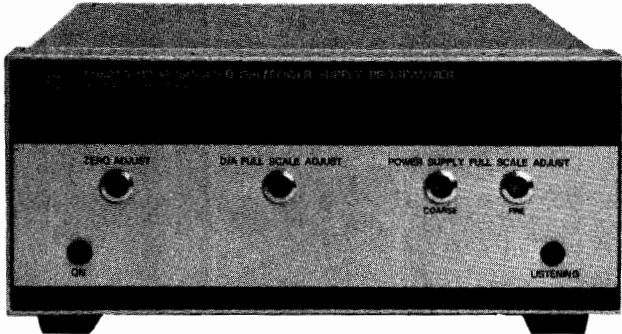

Description

The 59501A is an isolated digital-to-analog converter designed to provide a convenient interface between the Hewlett-Packard Interface Bus and HP power supplies. With the 59501A, a wide range of DC voltages and currents becomes automatically controllable via the HP-IB. With proper wiring, the built-in isolation devices protect other instrumentation on the HP-IB from damage that could be caused by power supply outputs. In addition, an internal control circuit holds the output level near zero until programmed data is received. A programmable High/Low range control improves resolution by ten-to-one.

Power supply control is accomplished through the 59501A's programmable output voltage and programming network (see figure 1). By making the appropriate connections between the 59501A's rear terminals and the remote programming terminals on the supply, the output voltage (or current) of the supply can be programmed from zero to its full rated output. The 59501A front panel controls provide fast and easy calibration of power supply outputs. The Zero Adjust enables the user to correct for small offsets in power supply response to programmed inputs. The Power Supply Full Scale Adjust (part of programming network) enables the user to set the maximum output desired from the power supply when the 59501A is programmed to its maximum value. For example, this adjustment would normally be used to calibrate the maximum programmable output of a 320Vdc power supply to 320 volts. However, it could also be used to set the maximum to 200 volts.

In addition to its ability to program power supplies, the 59501A also can be used directly as a low level DC signal source. Unipolar and bipolar output modes are available with output voltages programmable from zero to 9.99 volts, or minus 10.0 to plus 9.98 volts. Output current up to 10 milliamps is available and is automatically limited to protect the 59501A and user equipment. The 59501A produces a full scale voltage change in approximately 250 μ s from the time the digital data is received.

Specifications

Digital to Analog Converter

DC output voltage: programmable in high or low ranges within the voltage limits shown below. Output mode is unipolar or bipolar and is selected by a rear panel switch.

Unipolar: 0 to 9.99 V (low range, 0 to 9.999 V).

Bipolar: -10 to +9.98 V, (low range, -1 to +0.998 V).

DC output current: 10 mA maximum.

PARD (ripple and noise): 2 mV rms/10 mV p-p.

Resolution: unipolar, 10 mV (low range, 1 mV). Bipolar, 20 mV (low range, 2 mV).

Accuracy: specified at 23°C \pm 5°C.

Unipolar: 0.1% + 5 mV (low range, 0.1% + 1 mV).

Bipolar: 0.1% + 10 mV (low range, 0.1% + 2 mV).

Stability: change in output over 8 hour interval under constant line, load, and ambient following a 30 minute warm-up. Stability is included in accuracy specification measurements over the temperature range indicated.

Unipolar: 0.04% + 0.5 mV (low range, 0.04% + .1 mV).

Bipolar: 0.04% + 1 mV (low range, 0.04% + .2 mV)

Temperature coefficient: unipolar, 0.01%/°C + 0.5 mV/°C (low range, 0.1%/°C + 0.1 mV/°C). Bipolar, 0.01%/°C + 0.5 mV/°C (low range, 0.01%/°C + 0.1 mV/°C).

Zero adjust: plus or minus 250 millivolts.

D/A Full scale adjust: plus or minus 5%.

Programming speed: the time required for output to go from zero to 99% of programmed output change is 250 μ s (measured with resistive load connected to output terminals).

Power Supply Programming

Programming network specifications: in the following specifications, M represents the calibrated full scale value of the supply being programmed and P is the actual programmed output. The full scale value (M) can be any value within the supply's output range and is calibrated with the 59501A programmed to its maximum high range output.

Accuracy: specified at 23°C \pm 5°C.

Unipolar: 0.05% M + 0.25% P (low range, 0.01% M + 0.25% P).

Bipolar: 0.1% M + 0.25% P (low range, 0.02% M + 0.25% P).

Isolation: 600 V dc between HP-IB data lines and output terminals.

Temperature coefficient: 0.005% M/°C + 0.015% P/°C (low range, 0.01% M/°C + 0.015% P/°C).

Programming resolution: 0.1% M (low range, 0.01% M).

Programming speed: D/A programming speed plus the programming speed of the power supply.

General

Temperature range: operation: 0 to 55°C, Storage: -40 to 75°C.

Power: 100, 120, 220, or 240 Vac (+6% -13%) 47-63 Hz, 10 VA (selectable on rear panel).

Size: 101.6 H x 212.9 W x 294.6 mm D (4" x 8.38" x 11.6")

Weight: Net 1.36 kg (3 lb). Shipping 1.81 kg (4 lb).

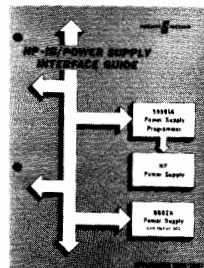
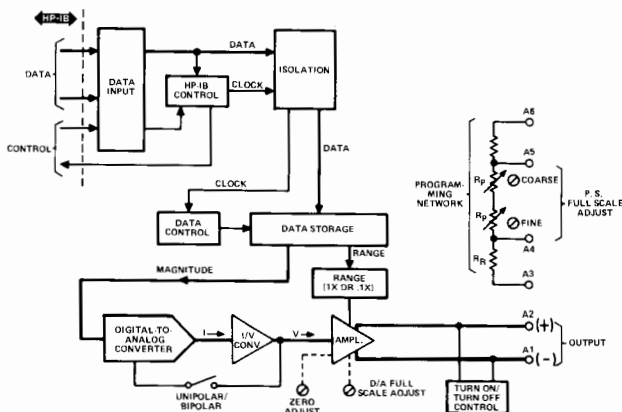

Ask for an 250-1 for complete details on HP-IB control of power supplies

Ordering Information

59501A HP-IB Isolated D/A Power Supply

Programmer

10833A HP-IB cable 1 m (3.3 ft)

10833B HP-IB cable 2 m (6.6 ft)

10833C HP-IB cable 4 m (13.2 ft)

10833D HP-IB cable 0.5 m (1.7 ft)

Price

\$700

\$ 70

\$ 75

\$ 85

\$ 70



POWER SUPPLIES

Digital Programmable: Binary or BCD

Models 6129C-6131C & 6140A

- Digitally programmable in binary or BCD
- HP-IB compatible option J99 & 59301A
- Fast, accurate, bipolar output
- Digital inputs isolated from analog output
- Internal storage of digital data
- Digitally programmable current latch (on DVS models)- or voltage limit (on DCS model)

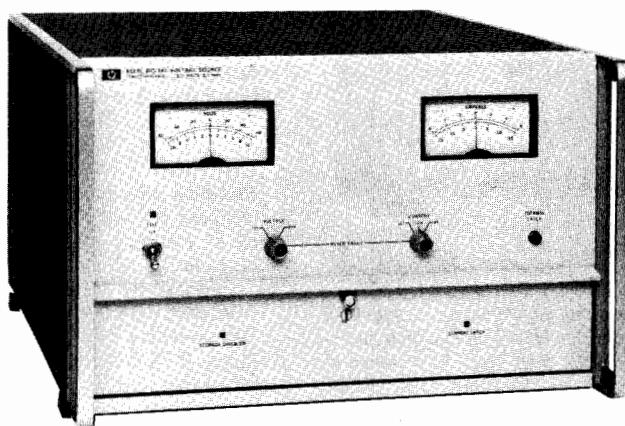

6129C

Digital Voltage Sources

HP's family of digital voltage sources (DVS's) includes models 6129C, 6130C, and 6131C. All models are programmable in binary or 8421 BCD and have many system-oriented features that enhance their use in automatic testing and control environments. Among these features are: isolation between the digital input and analog output lines, digital storage of programmed inputs, programmable current latch, analog input, and current monitoring terminals.

Isolation

All digital lines of the DVS's are isolated from the analog output. This feature is essential in automatic test systems to avoid forming ground loops that could impair system operation and damage the computer and instruments.

Nearly all computer manufacturers ground the power supplies for the digital I/O logic to the mainframe of the computer, which is connected to the ac power line ground. If a DVS did not have isolation, one of its analog output terminals would be connected to the digital input common line.

Internal Storage

The DVS's internally store the computer's output magnitude (voltage setting), polarity, range, and output latch/limit digital inputs when the computer's gate command is received. When the DVS has finished processing the digital input, it notifies the computer by transmitting its flag. Since the DVS stores the digital data, the computer does not have to continually refresh the DVS; it is free to carry out other important tasks. The DVS maintains its programmed output indefinitely, changing the output only when the computer changes the digital input data and sends another gate command.

In addition to eliminating the need for redundant programming by the computer, internal storage also facilitates the control of multiple DVS's from a single computer I/O channel. The number of DVS's that can be controlled from a single I/O channel depends on the capabilities of the computer's I/O data bus drivers. Most computers can easily drive up to eight DVS's.

Programmable Current Latch

Overcurrent protection is provided by a current latch circuit which can be externally programmed to one of eight values between 2% and 100% (six values for the 6131C) of the unit's rated output current. When activated, the current latch circuit turns off the output power amplifier reducing the output current to less than 20 mA. The reaction time of the current latch circuit (time between the start of a current overload and turn off of the power amplifier) can be adjusted by adding an external capacitor at the rear terminals. The upper current limit is safeguarded by a separate fixed current limit circuit that prevents the output current from exceeding 110% of the current rating. The computer is continuously informed of possible current overload or current latch conditions by status outputs which are fed back to the programming source.

Analog Input

In automatic test systems, it is often desirable to inject an ac "wobble" on top of a programmable dc level to measure impedance at various voltage levels, to simulate worst case power supply conditions for a module under test, or measure component parameters such as dynamic gain or transconductance. Many automatic control systems require this feature to provide "dither" for the system. All DVS's provide an analog input to fulfill this need.

Current Monitoring Terminals

The output current of all DVS's can be measured without upsetting voltage accuracy by connecting a voltmeter across the current monitoring terminals on the rear barrier strip.

Digital Current Sources

The Digital Current Source, Model 6140A is ideally suited for system applications requiring a rapidly programmable, high-precision source of current.

The isolation, internal storage, and analog input features described for the DVS's also apply to the DCS's. In addition, the DCS's have programmable voltage limiting and voltage monitoring terminals.

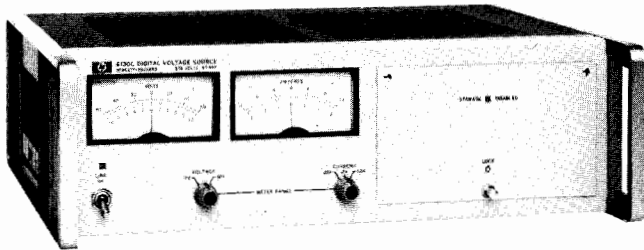

6130C, 6131C

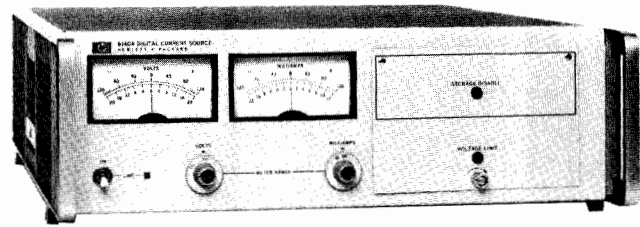

6140A

Common Specifications

AC Power Input

6129C: 115/230 V ac, 48-63 Hz; 6.4 A, 780 W @ 115 V ac; 115/230 V ac switch-selected.

6130C, 6131C: 115 V ac $\pm 10\%$, 48-440 Hz; 1.2 A, 100 W.

6140A: 115/230 V ac, 48-63 Hz; 1.2 A, 100 W @ 115 V ac; 115/230 V ac switch selected.

Dimensions

6129C: 266.7 H x 425.5 W x 542.9 mm D (10.5" x 16.75" x 21.38").

6130C, 6131C: 133.4 H x 425.5 W x 396.9 mm D (5.25" x 16.75" x 15.63").

6140A: 133.4 H x 425.5 W x 542.9 mm D (5.25" x 16.75" x 21.38").

Weight

6129C: net, 35 kg (78 lb). Shipping, 39 kg (85 lb).

6130C, 6131C: net, 15 kg (32 lb). Shipping, 18 kg (40 lb).

6140A: net, 17 kg (38 lb). Shipping, 20 kg (44 lb).

Cooling

6130C, 6131C: are convection cooled.

6129C, 6140A: are forced air cooled.

Programming time: less than 300 μ s for output to settle to within 0.1% of programmed change. Range change requires 2 ms.

Software for HP Computers

Drivers in the form of punched paper tape with accompanying operating manuals are available for Hewlett-Packard BCS, DOS, RTE, and BASIC software operating systems. Contact your HP Field Engineer for prices and ordering information.

AC Power Option

028: transformer tap change for 230 V ac $\pm 10\%$, single-phase input on 6130C and 6131C.

Price

N/C

Standard Interface Options

J20: binary interface for 12661A I/O programmer card for Hewlett-Packard computers

J99: interfacing DCPS's with calculator-based test control systems. All DCPS's may be modified to be compatible with ASCII-to-Parallel Converter, Model 59301A in calculator-based systems. In addition to DCPS modification, two items are supplied as part of Option J99: (1) a 1.83 m cable to connect DCPS to Model 59301A; (2) J99 Interface Note, containing Installation Instructions, Software Listings, Operating Instructions, and Diagnostics.

N/C

063: BCD interface for microcircuit logic levels

064: binary interface for microcircuit logic levels

\$170

N/C

N/C

Special Options

If none of the standard interface options meet your requirements, quotations for special options may be obtained from your Hewlett-Packard field engineer.

Accessories Available

14533B: Pocket programmer permits manual programming of all input functions by switch closure

14534A: Pocket programmer extension cable (3 ft)

14535A: HP computer interface kit includes 12661A computer I/O card, 14539A cable, verification software and BCS Driver. Up to eight DCPS's may be controlled from one 14535A

14539A: cable connects the first DCPS in a chain of up to eight instruments to the 12661A DVS programming card for Hewlett-Packard computers

14536A: chaining cable connects an additional DCPS to the existing chain of DCPS's

\$285

\$170

\$1700

\$245

\$290

Ordering Information

6129C: Digital Voltage Source

Opt 908: Rack Flange Kit

6130C, 6131C: Digital Voltage Source

6140A: Digital Current Source

\$4900

add \$31

\$2900

\$4900

Opt 908: Rack Flange Kit

add \$22

	Binary Instruments Option J20 & 064		BCD Instruments Option J99 & 063	
	X1 Range	X10 Range	X1 Range	X10 Range
6129C				
Output	± 16.384 V, 5 A	± 50.00 V, 5 A	± 9.999 V, 5 A	± 50.00 V, 5 A
Accuracy	1.5 mV	15 mV	1.5 mV	15 mV
Resolution	0.5 mV	5 mV	1 mV	10 mV
6130C				
Output	± 16.384 V, 1 A	± 50.00 V, 1 A	± 9.999 V, 1 A	± 50.00 V, 1 A
Accuracy	1 mV	10 mV	1 mV	10 mV
Resolution	0.5 mV	5 mV	1 mV	10 mV
6131C				
Output	± 16.384 V, 0.5 A	± 100.00 V, 0.5 A	± 9.999 V, 0.5 A	± 99.99 V, 0.5 A
Accuracy	1 mV	10 mV	1 mV	10 mV
Resolution	0.5 mV	5 mV	1 mV	10 mV
6140A				
Output	± 16.384 mA, 100 V	± 163.84 mA, 100 V	± 9.999 mA, 100 V	± 99.99 mA, 100 V
Accuracy	1μ A $\pm 0.01\%$	10μ A, $\pm 0.01\%$	10μ A, $\pm 0.01\%$	10μ A, $\pm 0.01\%$
Resolution	0.5μ A	5μ A	1μ A	10μ A

Accessories Furnished:

1251-0086 50-contact rear plug.

5060-7948 Plug-in extender board for DVS models.

5060-7948/5060-7982 Two plug-in extender boards for DCS.

POWER SUPPLIES

General Purpose: Dual-Tracking Outputs

Models 6227B & 6228B

- Two 50-watt power supplies for independent or tracking operation
- Built-in overvoltage protection crowbars

- Auto-parallel and auto-series capability
- Constant-current in addition to constant-voltage outputs

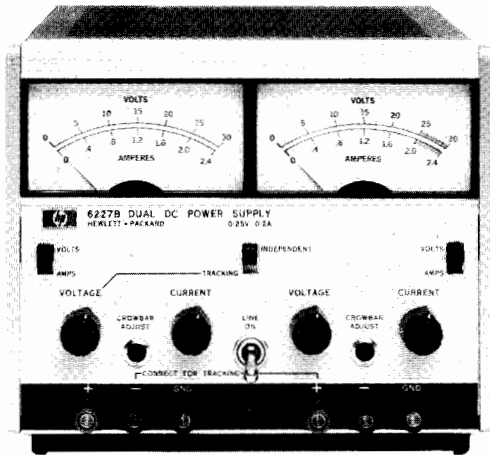

6227B

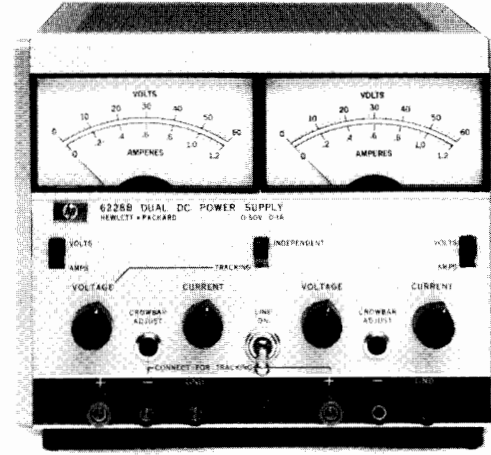

6228B

Description

These versatile lab supplies each house two identical 50 W regulated power supplies. A convenient front panel switch selects either independent or tracking operation. In the track mode, the right supply tracks the left within $0.2\% \pm 2 \text{ mV}$. The tracking mode is especially useful for powering operational amplifiers, push-pull stages, deflection systems, or any application where plus and minus voltages must track with insignificant error. The independent mode permits operation of the two supplies individually, in auto-parallel or in auto-series.

Each side of the dual supply can be operated as a constant-voltage or constant-current source, and each has its own crowbar for overvoltage protection. In the tracking mode, an overvoltage condition in either supply trips both crowbars. The power supply outputs are isolated up to 300 V from output to chassis or output to output.

Specifications

DC output: 6227B, 0-25 V @ 0-2 A; 6228B, 0-50 V @ 0-1 A.

AC input: 115 or 230 V ac $\pm 10\%$, 48-63 Hz, 260 W. Selected by rear panel switch.

CV load effect (load regulation): for a load current change equal to the current rating of the supply; $0.01\% + 1 \text{ mV}$.

CC load effect: for a load voltage change equal to the voltage rating of the supply; $0.01\% + 250 \mu\text{A}$.

Source effect (line regulation): for a change in line voltage between 104 and 127 V ac or 208 and 254 V ac at any output voltage and current within rating; CV, 1 mV; CC, $100 \mu\text{A}$.

PARD (ripple and noise): at any line voltage and under any load condition within rating (20 Hz to 20 MHz); CV, $250 \mu\text{V rms}/4 \text{ mV p-p}$; CC, $250 \mu\text{A rms}/2 \text{ mA p-p}$.

Temperature coefficient: output change per degree Celsius change in ambient following 30-minute warm-up; CV, $0.02\% + 200 \mu\text{V}$; CC, $0.02\% + 300 \mu\text{A}$ (6227B); $0.02\% + 150 \mu\text{A}$ (6228B).

Drift (stability): total drift in output (dc to 20 Hz) over 8-hour interval under constant line, load, and ambient following 30-minute warm up; CV, $0.2\% + 2 \text{ mV}$; CC, $0.2\% + 3 \text{ mA}$ ($0.2\% + 1.5 \text{ mA}$, 6228B).

Remote resistance programming: CV, $200\Omega/\text{V} \pm 1\%$; CC, $500\Omega/\text{A} \pm 10\%$ (6227B), $1\text{k}\Omega/\text{A} \pm 10\%$ (6228B).

Programming speed (CV): up-programming: no load, 40 ms/50 ms; full load, 200 ms/350 ms. Down-programming: no load, 400 ms/1 s; full load, 75 ms/50 ms.

Output impedance (typical): approximated by a resistance in series with an inductance; $2 \text{ m}\Omega/2\mu\text{H}$ (6227B); $6 \text{ m}\Omega/6\mu\text{H}$ (6228B).

Resolution (fine control): voltage, 5 mV (6227B), 10 mV (6228B); current, 1 mA (6227B), 0.5 mA (6228B)

Internal overvoltage crowbars: during independent operation, each supply is protected by its own crowbar. In the tracking mode, an overvoltage in either supply results in firing both crowbars.

Trip voltage margin: the minimum trip voltage above the operating output voltage of the supply to prevent false crowbar tripping: 7% of the output voltage + 1.5 V.

Trip voltage range: 6227B, 5-28 V dc. 6228B, 5-55 V dc.

Tracking error: in tracking mode, the slave supply is matched within $0.2\% \pm 2 \text{ mV}$ of the master.

Transient recovery time: in constant voltage, the output will recover in 50 μs to within 10 mV of its nominal value for a resistive load change demanding an output current change equal to the current rating of the supply. The nominal output voltage is defined as the mean between the no load and full load voltages.

Temperature Ratings

Operating: 0°C to 55°C .

Storage: -40°C to $+75^\circ\text{C}$.

Cooling: natural convection.

Weight (net/shipping): 11/12.9 kg (24/28 lb).

Size: 155H x 197 W x 310 mm D (6.13" x 7.75" x 12.25").

Finish: mint gray panel with olive gray case.

Options

009: four ten-turn output voltage and current controls replace all four concentric coarse and fine voltage and current controls.

015: four 3-digit graduated turns-counting dials and 10-turn controls replace concentric coarse and fine voltage and current controls.

040: interfacing for Multiprogrammer operation. Prepares standard HP power supplies for resistance programming by the HP Multiprogrammer.

Accessories

5060-8762: rack kit for mounting one or two dual supplies

5060-8760: filler panel to block unused half of rack when mounting only one dual supply

Ordering Information

6227B Dual Tracking Power Supply

6228B Dual Tracking Power Supply

Price
add \$100

add \$250

add \$150

\$72.50

\$26

\$1200

\$1200

- Short circuit proof
- Precise voltage control—four decade thumbwheel or switch and vernier
- Convection cooling

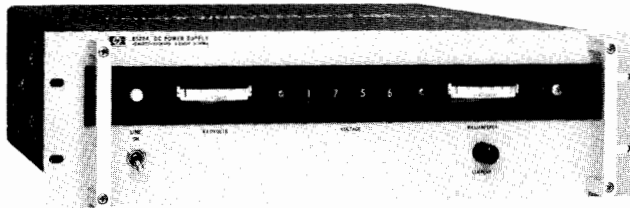

6521A, 6522A, 6525A

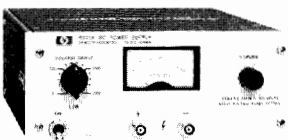

6515A

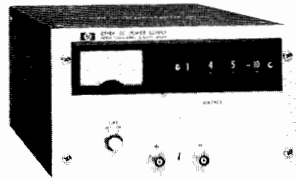

6516A

Description

6521A, 6522A, 6525A

This series of high performance power supplies has broad application both in the laboratory and in the system. They have sufficient output current to power devices such as TWT's, klystrons, magnetrons, backward-wave oscillators, high-power gas lasers, electron-beam welding devices, etc. Output voltage is set easily and precisely by a three-decade thumbwheel switch plus a thumbwheel vernier providing 0.002% resolution. In constant-voltage operation, a single-turn current control allows the current-limit point to be set to any value within the current rating. In constant-current operation, the current control varies the output current while the voltage controls (thumbwheels) provide an adjustable voltage limit. The supplies are protected against reverse voltage that could be generated by an active load. Protection from reverse current requires pre-loading the supply with a dummy load to ensure that the supply outputs current through the entire operating cycle of the load. Either the positive or negative terminal may be grounded or the supply may be operated floating at up to 200 V above ground.

6515A and 6516A

These high-voltage power supplies are lower in cost and output power than the 6521A-6525A supplies. Their small size, low price, and short-circuit-proof operation make them excellent high-voltage laboratory supplies, or high-voltage systems supplies where current requirements are not more than 6 mA.

Model 6515A employs a sixteen-position rotary switch and a ten-turn vernier control to adjust the output voltage. The rotary switch selects output voltage increments from 1 to 1500 V in 100-volt steps; the vernier control permits fine adjustment (100 mV resolution) over any 100-volt span. Model 6516A uses a three-decade thumbwheel switch plus a thumbwheel vernier for convenient and precise (1.0 V resolution) output voltage control.

- Floating output—can be used as a positive or negative source
- Front-panel meters
- Bench or rack mounting

Non-adjustable current-limit protection is provided on both models. On Model 6516A, the current-limit point is fixed at approximately 8 mA. On Model 6515A, the current limit value varies with the selected output voltage range as follows (voltage range/current limit): 0-300 V/7.5 mA, 400-700 V/65 mA, 800-1100 V/32 mA, 1200-1500 V/25 mA. Both supplies are protected against reverse voltage that could be generated by an active load. Pre-loading is necessary to protect the supplies from reverse current. Either the positive or negative terminal may be grounded or the supply may be operated floating at up to 1000 V above ground. Units are packaged in half-rack-width cases. They may be bench operated or mounted individually or in pairs using accessory rack-mounting kits.

Models 6521A, 6522A, and 6525A may be operated on 230 Vac, 48-63Hz, only through the use of an external accessory 230V to 115V step-down transformer. Suitable transformers with built-in receptacle, line cord and grounding-type plug may be ordered with the power supply as a Special Option. Contact your local HP Field Engineer for ordering information regarding models 6521A Special Option J08, 6522A Special Option J16, and 6525A Special Option J13.

Specifications

6521A, 6522A, 6525A

Accuracy: 1% of thumbwheel switch setting.

Temperature rating: operating 0 to 55°C; storage, -40 to +75°C.
Temperature coefficient, per °C: voltage, 0.012% of +1 mV. Current: 6521A, 0.2% + 0.2 mA; 6522A, 0.2% + 0.1 mA; 6525A, 0.2% + 0.05 mA.

Output impedance, typical: 0.1 ohm in series with 1 μH.

Load effect transient recovery: 50 μs to recover within 0.005% or 20 mV, whichever is greater.

Output modes: automatic cross-over constant-voltage/constant-current.

Meters: 2% of full scale accuracy. Scales: 6521A: 0-1 kV & 0-200 mA; 6522A: 0-2 kV & 0-100 mA; 6525A: 0-4 kV & 0-50 mA.

Power: 115 V ac ± 10%, 48-440 Hz, 4 A, 270 W (230 Vac available on special order).

Weight: net, 19 kg (42 lb). Shipping, 28.5 kg (63 lb).

Size: 133 H x 483 W x 457 mm D (5.25" x 19" x 18").

6515A and 6516A

Accuracy: 6516A, 1% of thumbwheel switch setting.

Temperature rating: operating, 0 to 55°C; storage, -40 to +75°C.

Temperature coefficient, per °C: voltage, 0.02% + 2 mV.

Load effect transient recovery: 100 μs to recover within 0.01% or 16 mV, whichever is greater.

Output modes: constant voltage with fixed current limit.

Meters: 2% of full scale accuracy. Scales: 6515A: 1.8 kV; 6516A: 3.5 kV.

Power: 6515A: 115 V ac ± 10%, 60 ± 0.3 Hz, 0.16 A, 19 W. (230 Vac available on special order) 6516A: 115 V ac ± 10%, 57-63 Hz, 1 A, 40 W.

Weight: 6515A: net, 4.1 kg (9 lb). Shipping, 5.0 kg (11 lb). 6516A: net, 7.7 kg (17 lb). Shipping, 9.5 kg (21 lb).

Size: 6515A, 89 H x 216 W x 299 mm D (3.50" x 8.50" x 11.75"). 6516A, 133 H x 216 W x 406 mm D (5.25" x 8.50" x 16").

RATINGS			PERFORMANCE										GENERAL	
DC Output		Model	Load Effect		Source Effect		PARD (rms/p-p)		Drift		Resolution		Options	Price
Volts	mA		Voltage	Current	Voltage	Current	Voltage	Current	Voltage	Current	V	C		
0-1000	0-200	6521A	0.005% or 20 mV	2% or 1 mA	0.005% or 20 mV*	1 mA	1 mV/150 mV	2 mA rms	0.036% + 3 mV	0.25% + 0.5 mA	20 mV	0.6 mA	J08	\$2100
0-1600	5	6515A	0.01% or 16 mV*	**	0.01% or 16 mV*	**	2mV/15 mV	**	0.05% + 5 mV	**	100 mV	**	15. 19	\$700
0-2000	0-100	6522A	0.005% or 20 mV*	2% or 1 mA*	0.005% or 20 mV*	1 mA	1mV/150 mV	1 mA rms	0.036% + 3 mV	0.25% + 0.25 mA	40 mV	0.3 mA	J08	\$2100
0-3000	6	6516A	0.01% or 16 mV*	**	0.01% or 16 mV*	**	1 mV/50 mV	**	0.05% + 5 mV	**	1 V	**	19	\$1050
0-4000	0-50	6525A	0.005% or 20 mV*	2% or 1 mA*	0.005% or 20 mV	1 mA	1 mV/150 mV	500 μA rms	0.036% + 3 mV	0.25% + 0.12 mA	80 mV	0.15 mA	J08	\$2050

*whichever is larger.

** This feature is not available.

▲See page 278 for complete option and accessory descriptions. Models 6521A-J08, 6522A-J16, and 6521A-J13 are special options for 230 V operation.

POWER SUPPLIES

Special Purpose: Precision Source

Models 6111A-6116A

- 0.025% output voltage accuracy
- 5-minute warm-up
- Built-in overvoltage crowbar

- Constant-voltage/current-operation
- Thumbwheel or ten-turn voltage controls
- 0.1% output voltage accuracy

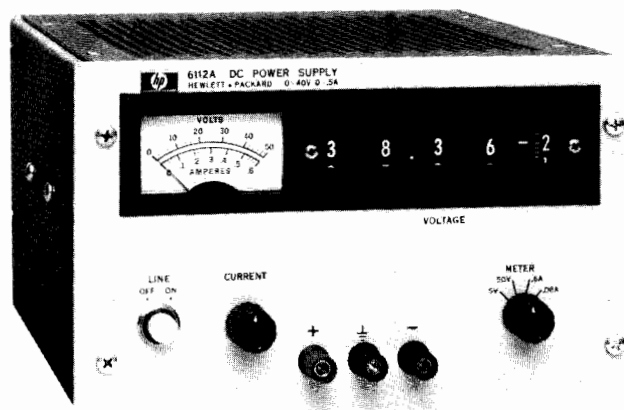

6111A, 6112A, 6113A, 6116A



6114A, 6115A

Description

6114A, 6115A

These 40-watt precision power supplies are ideal for applications where an accurate, highly stable, and easy-to-use source of dc voltage is required. Both models feature automatic dual range operation. For example, Model 6114A can supply 0–20 V at 0–2 A, and 20–40 V at 0–1 A, without manual range switching. Automatic output current range crossover occurs when the supply is providing greater than one-half of the maximum rated output voltage.

Output Voltage Controls

Pushbutton voltage controls on Models 6114A and 6115A allow the output voltage to be set rapidly and accurately. The setting is displayed in large, easy-to-read numerals. A fifth digit, set via a thumbwheel on the switch assembly, provides output voltage resolution of 200 μ V.

Specifications†

RATINGS			PERFORMANCE							Drift (Stability)	
DC Output		Model	Load Effect		Source Effect		PAR (rms/p-p)		Temperature coefficient	8-hour	90 day
Volts	Amps		Voltage	Current	Voltage	Current	Voltage	Current			
0-10	0-2	6113A	0.001% + 100 μ V	—	0.001%	—	40 μ V/100 μ V	—	0.001% + 10 μ V	0.01% + 100 μ V	—
0-20	0-1	6111A	0.001% + 100 μ V	—	0.001%	—	40 μ V/100 μ V	—	0.001% + 10 μ V	0.01% + 100 μ V	—
0-20, 20-40	0-2, 0-1	6114A	0.0005% + 100 μ V +100 μ V	0.01% +500 μ V	0.0005% +40 μ V	0.005% +40 μ A	40 μ V/200 μ V*	200 μ A/1 mA	0.001% + 15 μ V	0.0015% +15 μ V	0.0075% +30 μ V**
0-40	0-0.5	6112A	0.001% + 100 μ V	—	0.001%	—	40 μ V/100 μ V	—	0.001% + 10 μ V	0.01% + 100 μ V	—
0-50, 50-100	0-0.8 0-0.4	6115A	0.0005% + 50 μ V	0.01% +500 μ A	0.0005% +100 μ A	0.005% +20 μ A	40 μ V/200 μ V*	200 μ A/1 mA	0.001% + 15 μ V**	0.0015% +15 μ V	0.0075% +30 μ V
0-100	0-200 mA	6116A	0.001%+100 μ V	—	0.001%	—	40 μ V/100 μ V	—	0.001%+10 μ V	0.01% + 100 μ V	—

† Refer to page 254 for complete specification definitions and page 278 for option descriptions.

** Specified with final decade pot set to zero. If pot is set to value other than zero, pot wiper jump effect may cause drift of 0.0015% + 200 μ V (90-day).

* 200 μ V p-p noise is typical with a maximum 400 μ V p-p spike of less than 1 μ s duration occurring repetition rate of twice power line frequency under worst case conditions of high line, full output voltage. When operated at 400 Hz input, peak-to-peak ripple is less than 10 mV.



Output Current Controls

A front-panel control allows the output current to be set to any desired value within the maximum rating. Using this control, the supplies can be operated as constant-current sources with 0.01% current regulation. A light-emitting diode current mode indicator immediately lights either when the supply is operated in the gross current limit region, or when the output current level established by the setting of the front panel control is reached.

Remote Programming

These supplies can be remote programmed by means of an external voltage or resistance. When remote resistance programmed, put voltage accuracy is 0.01% plus the accuracy of the remote programming resistor, and output current accuracy is 0.25% plus the accuracy of the remote programming resistor.

For computer controlled applications, these supplies are designed to be digitally programmed with the HP Model 6940B Multiprogrammer or 6941B Multiprogrammer Extender. They can also be used with the 59501A HP-IB Isolated D/A Power Supply Programmer.

Overvoltage Protection

A circuit technique used in these supplies causes the output voltage to drop completely to zero once the overvoltage protection circuit has been triggered, rather than to only 1–3 V as is typical with other SCR crowbars. This same circuit technique also permits the trip threshold to be set as low as 0.5 V, thus providing load protection at very low output voltage levels.

6111A, 6112A, 6113A and 6116A

Although these 20-watt precision power supplies do not provide quite the level of performance and flexibility of Models 6114A and 6115A, they are lower in cost and are suitable for many precision power applications. Output voltage is adjusted by a five-decade thumbwheel voltage programmer for convenient and precise (100 μ V resolution) adjustment of output voltage. A single-turn current control allows full-range adjustment of the current-limit point.

Additional features include a volt/ampere meter and associated meter function switch. The four-position function switch selects either of two output voltage or output current ranges (X1, X0.1) for display on the panel meter.

The d-c output of these supplies is floating, allowing the supplies to be used as either positive or negative sources. Terminals for +OUT, -OUT, and GND are provided on both the front and rear of the supply. The rear terminal strip also includes terminals for remote resistance programming, remote sensing, and auto-series, auto-tracking operations.

Units are packaged in 5¼-inch high, half-rack cases which may be bench operated or rack mounted using accessory rack mounting hardware.

General Specifications—(See Table Also)

Temperature rating: all precision models; operating 0° to 50°C. Storage, -40° to +75°C.

DC output isolation: output terminals of precision models may be floated up to 300 V above ground.

Remote sensing: provided on all precision models.

Power: 104–127 or 208–250 V ac selected by switch, 48–440 Hz, 150 VA maximum.

Size: 166 H x 197 W x 336 mm D (6.5" x 7.75" x 13.25").

Weight: net, 7.7 kg (17 lb). Shipping, 9.5 kg (21 lb).

6111A, 6112A, 6113A and 6116A

Power: 115 V ac \pm 10%, 43–63 Hz, 0.5 A, 52 W (for 230 V, order Optn. 028).

Size: 133 H X 216 W x 318 mm D (5.25" x 8.5" x 12.5").

Weight: net, 5 kg (11 lb). Shipping, 6.8 kg (14 lb).

6114A, 6116A

Weight: net, 7.7 kg (17 lb). Shipping, 9.5 kg (21 lb).

Size: 155 H x 197 W x 318 mm D (6" x 7.75" x 12.5").

Specifications, Continued

					REMOTE CONTROL								GENERAL		
Accuracy	Resolution	Output Z (Typical)	Load Transient Recovery	Output Mode	Resistance Coefficient		Voltage Coefficient		UP \uparrow		DOWN \downarrow		Overvoltage Protection	Δ Options	Price
					Voltage	Current	Voltage	Current	NL	FL	NL	FL			
0.1% + 1 mV	20 μ V	0.2 m Ω +1 μ H	50 μ s 50 mV	CV/CL	1 k Ω /V \pm 0.1%	—	1 V/V \pm 0.1%	Δ	—	—	—	—	Opt 11, 3–13 V	11, 28, 40	\$950
0.1% + 1 mV	200 μ V	0.5 m Ω +1 μ H	50 μ s 50 mV	CV/CL	1 k Ω /V \pm 0.1%	—	1 V/V \pm 0.1%	Δ	—	—	—	—	Opt 11, 2.5–23	11, 28, 40	\$900
0.025% + 1 mV	200 μ V	0.05 m Ω +3 μ H	<50 μ s, 50 mV	CV/CC	2 k Ω /V \pm 0.01%	500 Ω /A \pm 0.25%	1 V/V \ddagger	0.5 V/A \pm 1%	1.75 s	1.75 s	350 ms	100 ms	STD, 0.5–45V	9, 15	\$1200
0.1% + 1 mV	200 μ V	2 m Ω +1 μ H	50 μ s 50 mV	CV/CL	1 k Ω /V \pm 0.1%	—	1 V/V \pm 0.1%	Δ	—	—	—	—	Opt 11, 2.5–44 V	11, 28, 40	\$900
0.025% + 1 mV	200 μ V	0.05 m Ω +3 μ H	<50 μ s, 50 mV	CV/CC	2 k Ω /V \pm 0.01%	1 k Ω /A \pm 0.25%	1 V/V \ddagger	1 V/A \pm 1%	4.5 s	4.5 s	500 ms	175 ms	STD, 0.5–110 V	9, 15	\$1200
0.1% + 1 mV	200 μ V	10 m Ω +1 μ H	—	CV/CL	1 k Ω /V \pm 0.1%	—	1 V/V \pm 0.1%	Δ	—	—	—	—	Opt 11, 20–106 V	11, 28	\$825

Δ See page 278 for complete option and accessory descriptions.

\uparrow UP = increasing output voltage. NL = No output load current. FL = Full rated output load current.

\ddagger Accuracy is equal to accuracy of remote programming device \pm 200 μ V.

Δ This feature is not available.

— Performance is not specified.

POWER SUPPLIES

Special Purpose: Constant Current Sources

Models 6177C, 6181C & 6186C

- Continuously variable voltage limit
- Output useful to micro-ampere region

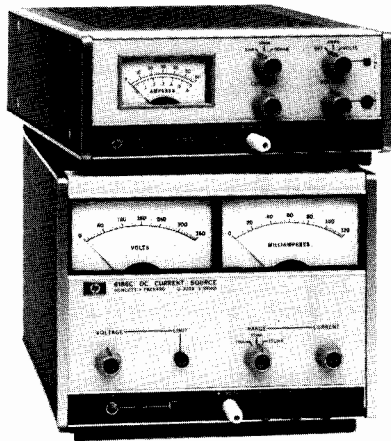

6177C, 6181C

6186C

Description

These solid-state constant-current sources are ideal for semiconductor circuit development, component testing, and precision electroplating applications.

Their high-speed remote programming characteristics make these supplies useful in testing and sorting semiconductors, resistors, relays, meters, etc. The ability to superimpose ac modulation on the dc output permits the supplies to be used for measurement of dynamic or incremental impedance of circuit components.

Specifications

Load effect (load regulation): less than 25 ppm of output + 5 ppm of range switch setting for a load change which causes the output

- High output impedance—no output capacitor

voltage to vary from zero to maximum.

Source effect (line regulation): less than 25 ppm of output + 5 ppm of range switch setting for a change in the line voltage from 104 to 127 V ac (or 127 to 104 V ac) at any output current and voltage within rating.

Load effect transient recovery: less than 800 μ s for recovery to within 1% of nominal output current following a full load change in output voltage. (On 6186C, recovery time for 100 mA/10 mA/1 mA ranges is 1 ms/1.6 ms/4 ms, respectively.)

Temperature coefficient: output change per degree C is less than 75 ppm of output current +5 ppm of range switch setting.

Drift (stability): less than 100 ppm of output current +25 ppm of range switch setting. Stability is measured for eight hours after one hour warm-up under conditions of constant line, load, temperature, and output setting.

Resolution: 0.03% of range switch setting.

Temperature rating: operating 0, to 55°C, storage, -40 to +75°C.

Accessories

5060-8764: rack adapter for rack mounting one or two 6177C or 6181C supplies

5060-8762: rack adapter for rack mounting one or two 6186C supplies

5060-8530: filler panel for Models 6177C, 6181C

5060-8760: filler panel for Model 6186C

Options

015: three-digit graduated turns-counting current control replaces front panel current knob

028: 230 V ac \pm 10%, single-phase input. Models 6177C and 6181C only

Ordering Information

6177C, 6181C Constant Current Source

6186C Constant Current Source

Price

\$70

\$72.50

\$44

\$26

add \$75

N/C

\$950

\$1400

Model		6177C	6181C	6186C
Output Current \ddagger		0-500 mA	0-250 mA	0-100 mA
Voltage Compliance Δ		0-50 V dc	0-100 V dc	0-300 V dc
Output Ranges	A	0-5 mA	0-2.5 mA	0-1 mA
	B	0-50 mA	0-25 mA	0-10 mA
	C	0-500 mA	0-250 mA	0-100 mA
AC Input		115V ac \pm 10%, 48-63 Hz; 0.6 A, 55 W at 115 V ac For 230 V ac see Option 028	115 V ac \pm 10%, 48-63 Hz; 0.6 A, 55 W at 115 V ac For 230 V ac see Option 028	115/230 V ac, 48-63 Hz; 0.9 A, 90 W at 115 V ac 115/230 V ac switch
Constant Current	Voltage Control (accuracy: 0.5% of output current +0.04% of range)	Range A	200 mV/mA	1 V/mA
		Range B	20 mV/mA	100 mV/mA
		Range C	2 mV/mA	10 mV/mA
Remote Programming	Resistance Control 1% of output control +0.04% of range)	Range A	400 ohms/mA	2 k Ω /mA
		Range B	40 ohms/mA	200 ohms/mA
		Range C	4 ohms/mA	20 ohms/mA
Voltage Limit Remote Programming	Voltage Control (Accuracy: 20%)		1 V/V	1 V/V
		Resistance Control	870 ohms/V	435 ohms/V
		Accuracy	25%	25%
Typical Output Impedance (R in parallel with C)*	Range A	R = 330 Meg, C = 500 pF	R = 1330 Meg, C = 10 pF	R = 10,000 Meg, C = 900 pF
	Range B	R = 33 Meg, C = 0.005 μ F	R = 133 Meg, C = 100 pF	R = 1,000 Meg, C = 700 pF
	Range C	R = 3.3 Meg, C = 0.05 μ F	R = 13.3 Meg, C = 1000 pF	R = 100 Meg, C = 1500 pF
PAR (Ripple and Noise): rms/p-p (dc to 20 MHz) with either output terminal grounded	Range A	1.6 μ A rms/40 μ A p-p	0.8 μ A rms/20 μ A p-p	0.2 μ A rms/5 μ A p-p
	Range B	16 μ A rms/200 μ A p-p	8 μ A rms/100 μ A p-p	2 μ A rms/50 μ A p-p
	Range C	160 μ A rms/1 mA p-p	80 μ A rms/500 μ A p-p	20 μ A rms/500 μ A p-p
Programming Speed: from 0 to 99% of range switch setting with a resistive load **(Output Current Modulation)		6 ms	6 ms	10 ms
Dimensions:		7.75" (W) x 3.44" (H) x 12.38" (D) 197 mm (W) x 88 mm (H) x 315 mm (D)	7.75" (W) x 3.44" (H) x 12.38" (D) 197 mm (W) x 88 mm (H) x 315 mm (D)	7.75" (W) x 3.44" (H) x 12.38" (D) 197 mm (W) x 158 mm (H) x 315 mm (D)
Weight: (Net/Shipping)		4.53 kg (10 lb)/5.9 kg (13 lb)	4.53 kg (10 lb)/5.9 kg (13 lb)	5.9 kg (13 lb)/7.7 kg (17 lb)

* This network is a simplified representation of a complex network. The formula $Z = R X_C / \sqrt{R^2 + X_C^2}$ is used for frequencies up to 1 MHz by substituting the values given for R and C. Above 1 MHz, the output impedance is greater than the formula would indicate.
** Output current can be modulated 100% up to 50 Hz; percent modulation decreases

linearly to 10% at 500 Hz.
 \ddagger For operation above 40°C the maximum output current must be reduced linearly to 80% of rating at 55°C (maximum temperature).
 Δ Minimum voltage obtainable with voltage limit control is 0.5 V.

- High speed remote programming
- Overload protection
- Wide-band response

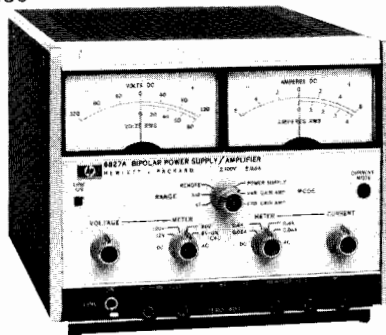

6825A-6827A

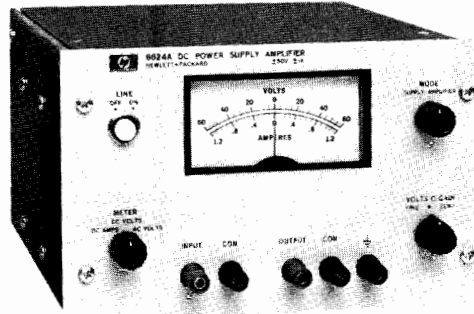

6824A

Description

The Power Supply/Amplifier is a general-purpose instrument useful in any laboratory engaged in research and development of electronic systems, circuitry, or components. The unit can be operated in one of two basic operating modes: power supply or amplifier. Terminals at the rear permit access to various internal control points to further expand the operational capabilities of the instrument. The resulting flexibility lends the Power Supply/Amplifier to an almost unlimited number of applications.

Models 6825A through 6827A

These models feature dual-range output and Constant-Voltage/Constant-Current operation. Output voltage and current as a dc supply, or gain as a power amplifier, are remotely controllable and are compatible with Hewlett-Packard Multiprogrammer Systems.

As a dc power supply, the unit can furnish a bipolar, Constant-Voltage or Constant-Current output. It can be remotely programmed with a resistance, voltage, or current and its high speed programming characteristics adapt it to a wide variety of laboratory and production testing applications. The supply can sink, as well as source, current permitting it to serve as a variable load device.

As a direct-coupled power amplifier, each unit offers a signal-to-noise ratio of approximately 80 dB at full output with low distortion and a frequency response up to 40 kHz in the fixed gain mode.

Model 6824A

Although this model does not provide quite the level of performance and flexibility of Models 6825A through 6827A, it is lower in cost and is suitable for many applications.

As a power supply, this unit offers Constant-Voltage/Current-Limiting operation, remote programming, and Auto-Series, Auto-Parallel operation.

As a power amplifier, the unit exhibits a high signal-to-noise ratio with a 20 dB gain from dc to 10 kHz. It is useful in servo systems, as a pulse or oscillator amplifier, for motor control, and a variety of other applications.

General Specifications

Temperature: operating, 0 to 55°C, storage, -40 to +75°C.

Power: 6824A, standard input voltage is 104-127 V ac, 48-63 Hz. Order Option 028 for 230 V ±10% operation. 6825A & 6826A, 6827A, switchable, 100, 120, 220, or 240 V ac, -13% +6%, 48-63 Hz, 150 W.

Size: 6824A, 131 H x 209 W x 303 mm D (5¹/₃₂" x 8¹/₃₂" x 11¹⁵/₁₆"). 6825A, 6826A & 6827A, 155 H x 198 W x 316 mm D (6¹/₃₂" x 7²⁵/₃₂" x 12⁷/₁₆").

Weight: 6824A, 7.7 kg (17 lb), 6825A, 6826A & 6827A, 8.2 kg (18 lb).

Power Supply Specifications

RATINGS			PERFORMANCE												
DC Output		Model	LOAD EFFECT		Source Effect		Pard (rms/p-p)		Transient Recovery		Resolution		Output Z (Typical)	Options ▲	Price
Volts	Amps		Voltage	Current	Voltage	Current	Voltage	Current	Time	Level	Voltage	Current			
-5 V to +5 V/ -20 V to +20 V	0-2.0 A Both Ranges	6825A	0.01% + 1 mV	0.01% + 250 μA	0.01% + 2 mV	0.01% + 250 μA	10/30 mV	5/15mA	100 μs	20 mV	40 mV	6 mA	0.5 mΩ, 1.5 μH	9	\$1400
-5 V to +5 V/ -50 V to +50 V	0-1.0 A Both Ranges	6826A	0.01% + 1 mV	0.01% + 250 μA	0.01% + 5 mV	0.01% + 250 μA	6/35 mV	0.8/5mA	100 μs	50 mV	100 mV	3 mA	1 mΩ, 1.5 μH	9	\$1400
-10 V to +10 V/ -100 V to +100 V	0-0.5 A Both Ranges	6827A	0.01% + 1 mV	0.01% + 250 μA	0.01% 10 mV	0.01% + 250 μA	10/50 mV	0.4/5mA	100 μs	100 mV	200 mV	1.5 mA	2 mΩ, 4 μH	9	\$1400
-50 V to +50 V	0-1.0 A	6824A	0.02% + 5 mV	—	0.02% + 5 mV	—	10 mV rms	—	100 μs	0.02% + 5 mV	—	—	—	9, 28	\$800

†Refer to page 237 for complete specification definitions.

▲See page 260 for complete option and accessory descriptions.

Power Amplifier Specifications

RATINGS			PERFORMANCE									
Output		Model	Voltage Gain		Frequency Response, +1, -3dB		Distortion at full output		Input Z (Typical)	Programming Coefficients		
Volts	Amps		Fixed	Variable	Fixed Gain	Variable Gain	100 Hz	10 kHz		Gain*	Voltage	Current
10 V p-p or 40 V p-p	2 A pk	6825A	1X 4X	0-2X 0-8X	dc -40 kHz	dc -15 kHz	0.1% THD	0.5%	10 kΩ	Rf/10.24 kΩ 4 Rf/10.24	1 V/V 4 V/V	2 A/V
10 V p-p or 100 V p-p	1 A pk	6826A	1X 10X	0-2X 0-20X	dc -40 kHz	dc -15 kHz	0.1% THD	0.5%	10 kΩ	Rf/10.24 kΩ 10 Rf/10.24 kΩ	1 V/V 10 V/V	1 A/V
20 V p-p or 200 V p-p or	0.5A pk	6827A	2X 20X	0-4X 0-40X	dc -30 kHz	dc -15 kHz	0.1% THD	1%	10 kΩ	2 Rf/10.24 kΩ 20 Rf/10.24 kΩ	2 V/V 20 V/V	1 A/V
100 V p-p	1 A pk	6824A	—	0-10X	—	dc -10 kHz	0.1% THD	—	2 kΩ	—	1 V/V	—

*Rf is the gain programming resistance.

POWER SUPPLIES

Options and Accessories

For general purpose, autoranging and special purpose models

A wide range of options is available to modify standard models to meet the requirements of a particular application. Various general purpose, autoranging and special purpose power supply descriptions are found on pages 255 through 277. To determine which options are available for a particular power supply, refer to the appropriate product page. Always check the AC input voltage, current, and frequency requirements for the standard model and the AC power available in the area or country where the power supply will be used. If options are required, they must be specified with the order.

- 002:** System Interface, 6012A & 6024A Price \$300
- 005:** 50 Hz ac input: optimizes power supplies that require adjustment/modification for 50 Hz operation. Order only when listed as required in specifications for a particular model. N/C
- 009:** ten-turn output controls. Replaces single-turn output voltage and current controls (where applicable and available). 6114A, 6115A, 6206B-6209B, 6294A, 6299A and 6824A-6827A \$30
- 6200B-6203B, 6205B, 6259B-6291A, and 6296A \$60
- 6227B, 6228B, 6253A, and 6255A \$100
- 010:** chassis slides. For access to rack mounted power supplies. 6263B-6267B \$85
- 6253A, 6255A, 6259B-6261B, 6268B, 6269B, & 6428B-6448B \$160
- 6453A, 6456B & 6459A \$250
- 011:** internal overvoltage protection crowbar. Protects delicate loads against power supply failure or operator error. Dual output models have dual crowbars. Single output models, where available. \$70
- Dual output models, 6205B, 6253A, & 6255A \$140
- 015:** three-digit graduated turns-counting dial and ten-turn controls for output voltage and current (where applicable and available). Improves resettability of power supply output \$75
- 6177C, 6181C, 6186C, and 6515A \$75
- 6114A, 6115A, 6206B, & 6224B-6226B \$100
- 6207B, 6209B, 6294A & 6299A \$125
- 6200B-6203B, 6205B, 6259B-6291A, & 6296A \$250
- 6227B, 6228B, 6253A, & 6255A \$80
- 016:** 115 V ac $\pm 10\%$ single phase input. Consists of replacing power transformer and circuit breaker, and reconnecting bias transformer, RFI choke and fans. For model 6260B only \$50
- 019:** 230 V ac $\pm 10\%$, 50 ± 0.3 Hz, single phase input. Consists of replacing input transformer, line cord and fuse. Option 019 applies only to models 6515A & 6516A \$60
- 022:** voltage and current programming adjust. Allows the V and I programming coefficients and zero output to be conveniently adjusted to 0.1% accuracy via access holes in the rear panel. Consists of four potentiometers and resistors located inside the rear panel. Option 022 applies only to models 6259B-6274B \$30
- 023:** rack mounting attachments. Factory installed for mounting model 6464C-6483C in a standard 19" rack. N/C
- 026:** 115 V ac $\pm 10\%$, single phase input. Consists of replacing the input circuit breaker and reconnecting the power transformer, bias transformer, RFI choke, and fans. Option 026 applies only to models 6259B, 6261B, and 6268B N/C
- 027:** 208 V ac, $\pm 10\%$, single phase input. Consists of reconnecting power transformer taps, and other components where necessary. Order only when listed in the specifications for a particular model N/C
- 028:** 230 V ac $\pm 10\%$, single phase input. Consists of reconnecting power transformer taps, and other components where necessary. Order only when listed in the specifications for a particular model N/C
- 040:** multiprogrammer interface. Prepares standard HP power supplies for resistance programming by the 6940B Multiprogrammer or 6941B Multiprogrammer Extender. This option includes Option 022, special calibration, and protection check-out procedures (where required)

- 6111A-6113A \$40
 - 6205B, 6224B, 6226B, 6259B-6274B, & 6281A-6299A \$75
 - 6464C, 6466C, 6469C, & 6472C \$100
 - 6227B, 6228B, 6253A & 6255A \$150
 - 100:** 87-106 V ac, 47-63 Hz, single phase input N/C
 - 120:** 104-127 V ac, 47-63 Hz, single phase input N/C
 - 220:** 191-233 V ac, 47-63 Hz, single phase input N/C
 - 240:** 208-250 V ac, 47-63 Hz, single phase input N/C
- (Note: options 100, 220 and 240 are for models 6236B and 6237B only, and consist of setting an internal AC voltage selection switch and selecting appropriate line fuse.)

- 907:** Front Handle Kit (Part No. 5061-0089) \$32
- 908:** Rack Flange Kit (Part No. 5061-0077) \$25
- 909:** Opt. 907, 908 combined (Part No. 5061-0083) \$55
- Special Option J30:** Voltage to current converter. Required to prepare models 6427B-6448B and 6466C-6483C for use with the model 59501A HP-IB Isolated D/A Power Supply Programmer. Contact your local HP Field Engineer for ordering assistance. (Reference AN250-1, paragraph 4-37)

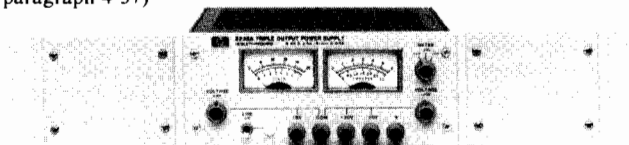

14513A Rack Kit for one 3.5" high supply
14515A Rack Kit for one 5.25" high supply

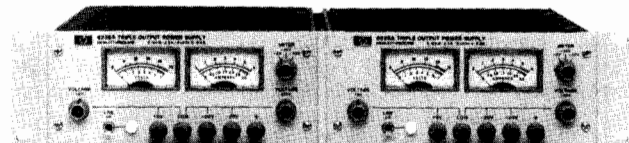

14523A Rack Kit for two 3.5" high supplies
14525A Rack Kit for two 5.25" high supplies

- Accessories**
- 14513A and 14523A rack kits apply to the following models: 6200-6209B, 6237B, 6281A, 6284A, 6289A, 6294A, 6299, 6515A
 - 14513A:** high rack kit for one supply \$55
 - 14523A:** 3.5" high rack kit for two supplies \$30
 - 14515A and 14525A rack kits apply to the following models: 6111A-6113A, 6116A, 6282A, 6286A, 6291A, 6296A, 6516A, 6824A.
 - 14515A:** 5.25" high rack kit for one supply \$60
 - 14525A:** 5.25" high rack kit for two supplies \$35
 - 14521A:** rack kit for one, two or three supplies \$115
 - Includes two filler panels. 14521A rack kit applies to the following models: 6212A-6218A.
 - 5060-8762:** adapter frame for rack mounting one or two 1/2 rack widths units or one, two or three 1/3 rack width units \$72.50
 - This frame applies to the following models: 6114A, 6115A, 6186C, 6224B-6228B, 6825A, 6826A, 6827A.
 - 5060-8764:** adapter frame for rack mounting one or two 1/2 rack width units. \$110
 - This frame applies to the following models: 6177C, 6181C.
 - 5060-8759:** Blank Filler Panel \$22.50
 - This 1/3 rack width panel applies to the following models: 6224B, 6226B.
 - 5060-8760:** Blank Filler Panel \$26
 - This 1/2 rack width panel applies to the following models: 6114A, 6115A, 6186C, 6227B, 6228B, 6825A, 6826A, 6827A.
 - 5060-8530:** Blank Filler Panel \$44
 - This 1/2 rack width panel applies to the following models: 6177C, 6181C.
 - 14545A:** casters-set of four \$85
 - Snap-on casters for one 6464C-6483C power supply. (For rack mounting information on these supplies, see Opt 023.)

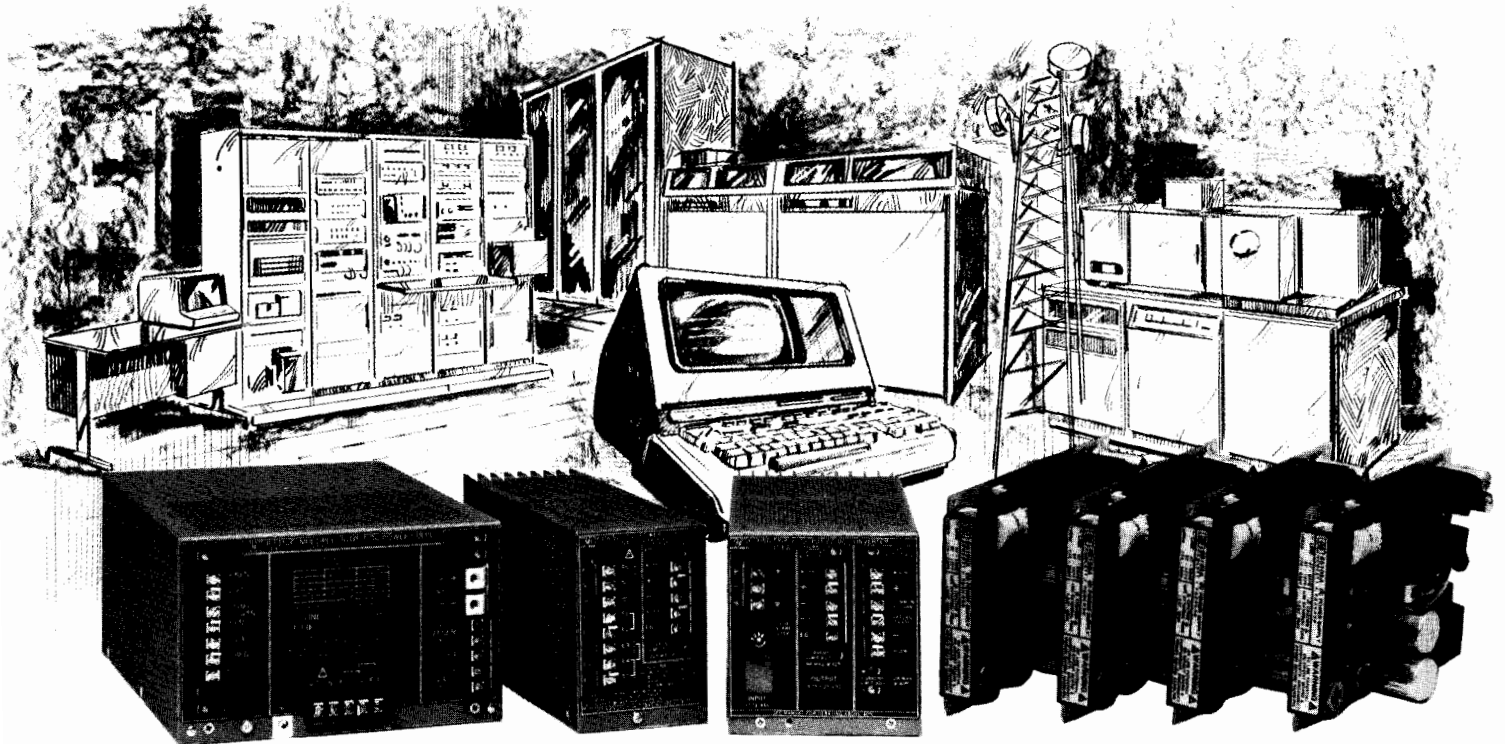

The selection of a power supply for today's electronic system requires careful evaluation. Sophisticated system electronics have placed new demands on the supply and, as always, the power supply is the very heart of the system. If it stops delivering power, the system stops. In your selection consider not only the obvious technical and cost considerations, but also the less tangible product factors that are provided for your OEM dollar.

Quality

Hewlett-Packard OEM supplies are thoroughly proven before they are introduced. Each product goes through a development cycle consisting of Engineering Breadboard, Lab Prototype and Production Pilot Runs. At each phase the units are evaluated for safety, specification compliance, environmental performance, workmanship, and serviceability. Before introduction as new products, all models undergo formal environmental testing in multiple tests including hi-pot, altitude, operating temperature, humidity, vibration, shock, EMC, this many tests again and more.

MTBF

We employ a comprehensive and conservative method of determining Mean Time Between Failure (MTBF). A component data base is maintained to provide actual component failure statistics and the MTBF is adjusted to reflect the actual working environment in which the components operate. Calculated MTBF objectives are confirmed with life tests.

As an illustration of HP's commitment to reliability, the 395,000 unit hours of life-test data for the 65105A, 50 Watt power supply is presented below per MIL-781B, Test Plan III. The data demonstrates with 90% confi-

dence a 50,000 hour MTBF at 50°C and more than 100,000 hours at room ambient conditions.

Life Test Acceptance Curve—65105A

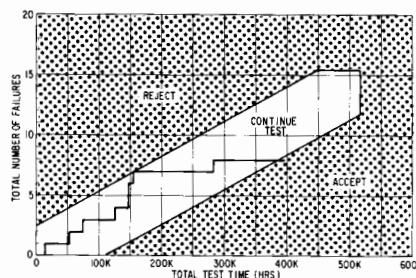

The 395,000 unit-hours represents a full year of testing 58 power supplies. It predicts an operating life of more than 20 years in typical applications. It's part of our commitment to you.

Safety

To assist you in complying with safety regulations, all HP modular power supplies are designed to meet UL specifications. New products are also designed to meet international safety regulations (e.g. VDE 0730). HP modular power supplies are UL listed, and a UL yellow card number will be provided upon request.

Service Support

Hewlett-Packard's service support is a major factor in the lasting value of our products. HP is ready to respond to your service needs with extensive world-wide service and spare parts facilities. Staffed by competent technical personnel, these facilities provide fast turn-around-time. All units are shipped with complete Operating and Service Manuals.

Special Designs

In some applications off-the-shelf power supplies will not meet your needs. In these instances, our Specials Engineering is ready to provide product modifications, assembled power systems, or applications assistance to help with your specific requirements. Just let your HP Field Engineer know.

Make or Buy

A crucial question in the make-or-buy decision is whether or not you want to expend the technical and financial resources to design and manufacture your own supplies.

It is important not to underestimate the difficulty involved in a power supply design. When evaluating your technical capabilities keep in mind that modern power supplies are state-of-the-art components. Much time will be required for electrical and mechanical design, prototypes and evaluation, and your engineers will be diverted from other more productive tasks.

To assist you with a make-or-buy decision we will be pleased to provide Application Note 236-1. This note assists you in conducting a Return on Investment (ROI) analysis by revealing both the obvious and hidden costs incurred in the manufacture of your own power supplies. Contact your local HP Field Engineer for a free copy.



Switching Supplies, AC to DC

50 Watts Card

Model	Output Voltage (Vdc)	Maximum Current (A dc)		100 Qty OEM Price
		40°C	50°C	
65105A	5	10.0	10.0	\$172
65112A	12	4.2	4.2	\$172
65115A	15	3.3	3.3	\$172
65312A	5	10.0	10.0	\$211
	+12	1.5	1.5	
	-15	1.0	1.0	
65315A	5	10.0	10.0	\$211
	+15	1.0	1.0	
	-15	1.0	1.0	
65317A	5	10.0	10.0	\$211
	+18	1.0	1.0	
	-18	1.0	1.0	
65512A	5	10.0	10.0	\$225
	+16	1.0	1.0	
	-16	1.0	1.0	
	+15 to 12	0.3-1.0	0.3-1.0	
	-5 to -12	0.3-1.0	0.3-1.0	
65612A	5	10.0	10.0	\$233
	+16	1.0	1.0	
	-16	1.0	1.0	
	+5 to 12	0.3-1.0	0.3-1.0	
	-5 to -12	0.3-1.0	0.3-1.0	
	-5 to -12	0.1-0.3	0.1-0.3	

550 Watts Fan Cooled

Model	Output Voltage (Vdc)	Maximum Current (A dc)		100 Qty OEM Price
		40°C	50°C	
63312F	5	50	42	\$900
	+12 to 15	10	8	
	-12 to 15	10	8	
63330F	5	50	42	\$980
	12 to 15	10	8	
	12 to 15	10	8	
63331F	5	85	70	\$1040
	+12	5	4	
	-12	5	4	
63340F	5	50	42	\$1140
	12 to 15	10	8	
	12 to 15	10	8	
	5	5	4	
63341F	5	35	29	\$1140
	24	5	4	
	12	10	8	
	12	6	5	
63350F	5	35	29	\$1180
	24	5	4	
	-12	9	7	
	12	6	5	
	12	6	5	
	-5	1	1	

110 Watts, Convection Cooled

63005E	5	22	18	\$520
63315E	5	18	15	\$600
	+15	2	1.6	
	-15	2	1.6	

300 Watts, Fan Cooled

62605L	5	60	50	\$700
--------	---	----	----	-------

500 Watts, Fan Cooled

62605M	5	100	87	\$780
--------	---	-----	----	-------

DC to DC Converters

110 Watts, Convection Cooled

61005E	5	22	18	\$480
61315E	5	18	15	\$600
	+12 to +15	2	1.6	
	-12 to -15	2	1.6	

Linear Supplies, AC to DC

10-20 Watts, Convection Cooled

62005A	5	2.0	2.0	\$272
62012A	12	1.5	1.5	\$272
62015A	15	1.25	1.25	\$272
62018A	18	1.0	1.0	\$272
62024A	24	0.75	0.75	\$272
62028A	28	0.70	0.70	\$272
62048A	48	0.45	0.45	\$272

80-200 Watts, Convection Cooled

62005G	5	16	16	\$504
62012G	12	12	12	\$504
62015G	15	10	10	\$504
62018G	18	9	9	\$504
62024G	24	7.5	7.5	\$504
62028G	28	6.5	6.5	\$504
62048G	48	4	4	\$504

40-90 Watts, Convection Cooled

62005E	5	8	8	\$328
62012E	12	6	6	\$328
62015E	15	5	5	\$328
62018E	18	4.5	4.5	\$328
62024E	24	3.75	3.75	\$328
62028E	28	3.25	3.25	\$328
62048E	48	2	2	\$328

30-140 Watts, Dual Output, Convection Cooled

62212A	±12	1.41/1.25	—	\$308
62215A	±15	1.25/1.1	—	\$308
62212E	±12	3.3/3	—	\$372
62215E	±15	3/2.75	—	\$372
62212G	±12	6/5	—	\$580
62215G	±15	5.2/4.5	—	\$580

65000A-Series Power Supplies 50 Watts, Up to 6 Outputs, 200 kHz Switching

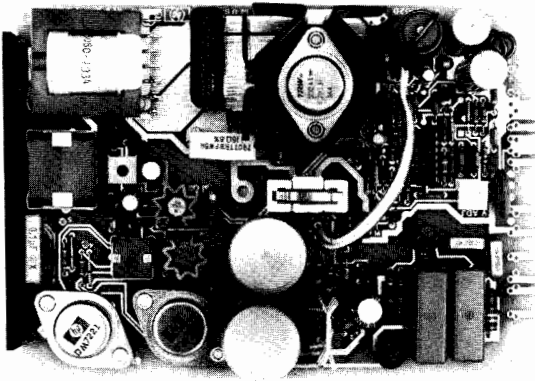

Breakthrough 200 kHz MOS Power FET switching with resonant sinewave power conversion makes possible the 65000A Series of 50 watt power supplies. They are smaller and lighter and provide increased reliability over conventional switching power supplies—more than 100,000 hour MTBF for single output models, verified by 395,000 hours of life tests.

The series includes eight models in three sizes with up to six outputs: single+2, triple+2, and quadruple+2, outputs. The main output of each model is 0.1% regulated and delivers up to 10 amperes of current. The "+2" outputs are the semiregulated outputs of multiple output models. They are isolated from the main output and are used to power the 2% regulated adjustable outputs.

Contact your HP Field Engineer for special output voltages from 4 to 28 Vdc and special control features.

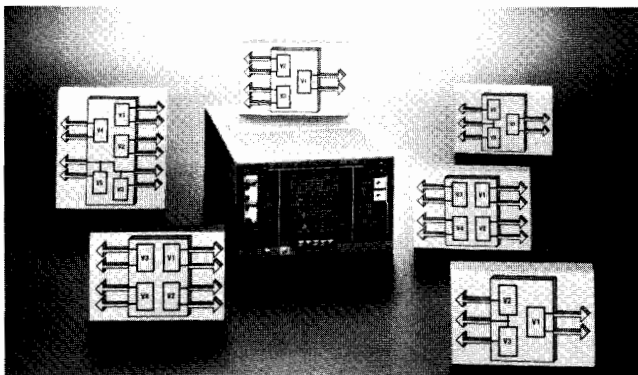

63300F-Series Power Supplies 550 Watt Up to 5 Outputs, 20 kHz Switching

The need for more features and the needs for end-product compliance with new safety and EMI regulations are placing more demands on your power supply. To help meet these demands, HP has a family of multiple-output 20 kHz switching power supplies. These supplies provide up to 85 amperes with voltages ranging from 5 to 24 volts. The basic design has the flexibility to allow modification to meet your requirements when the total power from all outputs combined is under 550 watts.

The minimum input voltage is 87 Vac to tolerate brownout conditions and to ensure performance where nominal line voltages are low. Carryover time is 40 milliseconds at nominal line voltage and full load, and built-in EMI suppression meets VDE 0871A.

Power Systems

- Custom designed systems are available assembled, tested and documented by Hewlett-Packard
- System component units for "do it yourself" power system solutions

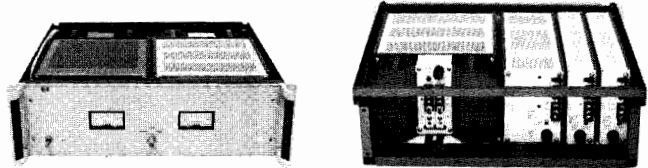

Custom Systems

Custom power systems can be assembled by installing suitable combinations of single and dual-output linear supplies and switching regulated supplies in rack mounting trays. If desired, Hewlett-Packard will assemble, wire, and test complete power supply systems to customer specifications using these modular power supplies and rack mounting accessories. Meters, switches, input and output connectors, and other components will be installed to meet your specific needs. Consult your local Hewlett-Packard Field Engineer for price and delivery information.

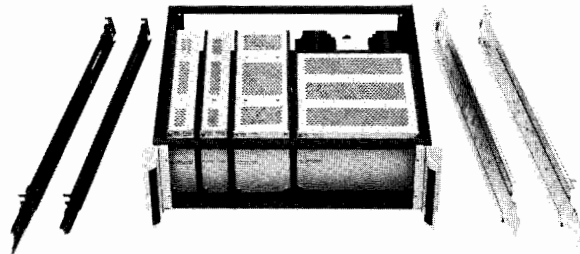

Accessories for Power Systems

The Model 62410A Rack Mounting Tray can accommodate any combination of Series 62000 linear supplies, Series 62200 dual linear supplies, Series 63000 switching-regulated supplies totaling a full rack width or less. It can be installed in a 19-inch rack directly or on slides. Detachable handles are included. The 62411A Blank Front Panel has a 2.25-inch clearance when installed on the tray for meters, switches, test jacks. Model 62413A Cooling Unit delivers 45 CFM of cooling air while occupying only 1.75-inches of rack space. The 62414A Slide Kit has a 20-inch slide for use with standard 19-inch wide racks of 20-inch depth (not for HP29400A or -B cabinets.) Model 62415A AC Distribution Panel is a mounting tray rear panel with a 3-terminal barrier strip, line cord, and fuse holder already installed. The 12692B Slide Kit has 22-inch slides for use with HP 29400A or -B cabinets.

EMI/RFI and HP 65000A Series Power Supplies—
Meets FCC and VDE requirements for Commercial Equipment

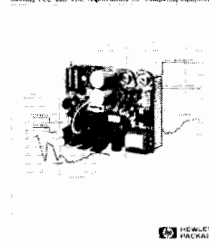

HP Hewlett-Packard
30 Watt Single & Multiple Output
Power Supplies
65000 Series

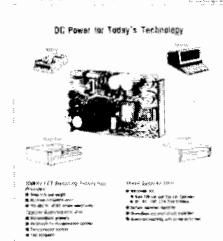

OEM modular power supply Technical Data and Application Notes are available from your local HP Field Engineer.



Recorders Provide Hardcopy Graphics

Graphics can make a maze of information meaningful and manageable when applied effectively. Graphics are the most efficient way to present data for interpretation and to see the relationships between values, such as the change in a variable over time or how one variable relates to another. X-Y, strip chart, and oscillographic recorders capture and display analog data signals.

X-Y Recorders

X-Y recorders plot Cartesian coordinate graphs from low frequency analog signals. Basic decision areas to consider in selecting an X-Y recorder include static performance, dynamic performance, specific features, and reliability.

Static performance: Static performance includes accuracy and resolution, both functions of the recorder's electronic and mechanical characteristics.

Dynamic performance: Dynamic performance includes slewing speed and acceleration, both characteristics essential to the capture of rapid, transient signal inputs.

Features: The importance of other features is determined by the application and the environment in which the recorder will be used. Additional features to consider include chart size, number of pens, time base capability,

rear inputs, event markers, preamps, and filters.

Strip Chart Recorders

Strip chart recorders produce permanent records of slowly varying analog signals versus time. Selection criteria include chart speeds, the writing system, features, and reliability.

Chart speeds: Each recorder can perform at multiple, user-selected speeds. Fast speeds capture rapid, close signals and slow speeds are ideal for long-term trend recording and paper economy.

Writing systems: A thermal writing system is ideal for long-term unattended operation. An ink writing system contains durable stainless steel or convenient disposable pen tips.

Features: The importance of features such as two pens depends upon the recorder's application and use.

Oscillographic Recorders

Oscillographic recorders measure and record multiple input voltages against time. Direct writing oscillographs accurately record analog signals in excess of 100 Hz and use a 40 to 50 mm channel width. Selection is based on number of channels, writing system, features, and reliability.

Number of channels: Oscillographs are generally available in 2, 4, or 8 channels. As

the number of channels increases, the cost per channel decreases.

Writing system: The writing system should be relatively maintenance free and should produce crisp, high-quality writing. Both ink and thermal writing systems are used in oscillographic recorders.

Features: The importance of other features, such as high pen resonance frequency, a long life pen system, and remote chart speed control, depend upon the recorder's application and use.

Hewlett-Packard's Recorders

HP's recorders have a long and continuous history of a high level of reliability in a wide variety of environments. OEM and volume end-user discounts are available for many recorder models.

Information and Literature

For more information on any of HP's recorders, contact your HP sales office or complete a postal reply card located in the back of this catalog. Operating and service manuals are shipped with each recorder. Application notes are also available, at no charge, from your sales office or by writing Hewlett-Packard. A list of available notes—including topics such as recording with input noise present, X-Y recorder dynamic response, X-Y recorder input connection configuration and input noise—is included elsewhere in this catalog.

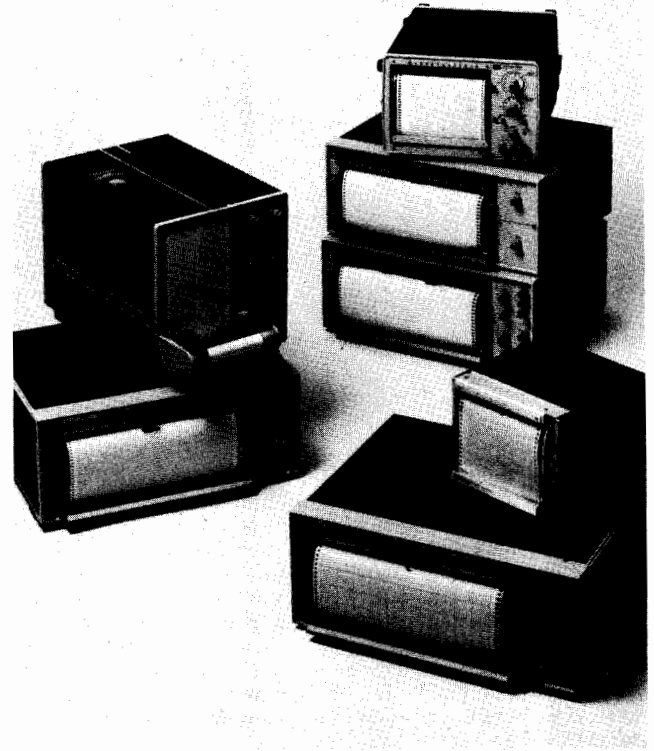
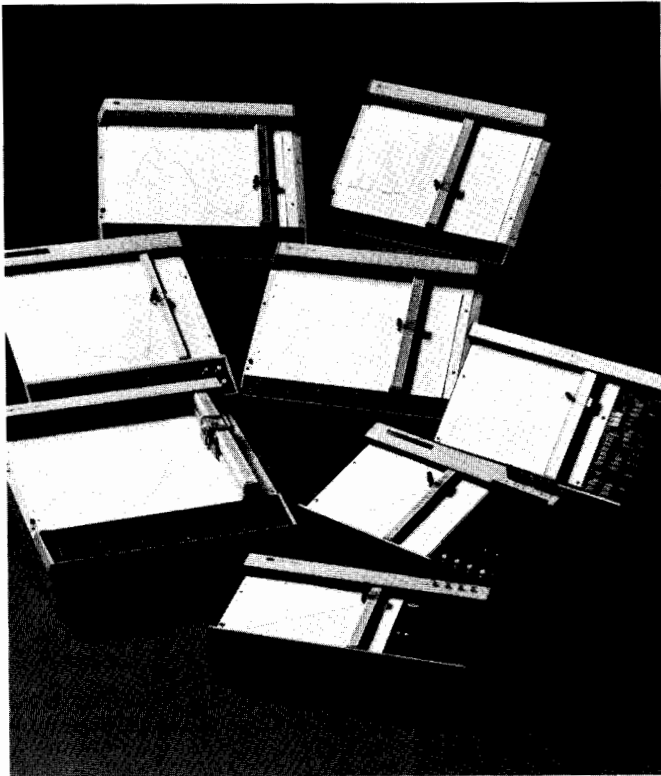

Review of HP's X-Y Recorders

All include electrostatic holddown, disposable fiber tip pens, offsettable zero, convenient front panel inputs and controls, easy paper alignment, rack mount capability, mechanical components designed for rugged use, long life, and long-term alignment, and optional or standard time base.

Laboratory X-Y recorder models: For general purpose use and high quality.

28 × 41.9 cm (11 × 17 in.) chart size

7004B: Plug-in flexibility, 14 input ranges (determined by plug-in), auto time base reset.

7044B: High dynamic performance, 14 input ranges, event marker, TTL remote control, auto time base reset. Accepts A3 size paper.

7045B: Similar to 7044B except with very high dynamic performance.

7046B: Similar to 7044B except with very high dynamic performance and two pens.

7047A: High sensitivity for recording low level signals, 12 input ranges, high dynamic response. Accepts A3 size paper.

22 × 28 (8½ × 11 in.) chart size

7015B: Low cost, 3 input ranges, time base, TTL remote control, accepts A4 size paper.

7034A: Same as 7004B except for size.

7035B: Floating guarded inputs, 5 input ranges.

OEM application X-Y recorders: These recorders are designed for dedicated applications and provide cost savings.

7010B: Dedicated range, one pen, low cost, medium response. Accepts A4 or 8½ × 11 in. paper.

7040A: Dedicated range, one pen, high dynamic performance. 40 options available. Accepts A3 or 11 × 17 in. paper.

7041A: Similar to 7040A except with very high dynamic performance.

Review of HP's Strip Chart Recorders

Standard features include chart tables that tilt at three angles, front panel chart advance thumbwheels, and chart storage. All have ink writing systems and thermal-writing options are available on some models. 2-pen models permit both channels to use the full resolution of the chart width simultaneously.

Laboratory strip chart recorders: A full complement of span and chart speed selections plus convenient options provide the best price/performance package available. Two sizes are offered:

12 cm (5 in.) chart size

680: Compact, ideal for general purpose recording, 10 input ranges, 8 chart speeds.

7155B: Portable, battery operated for field application, one disposable pen, 16 input ranges, 7 speeds.

25 cm (10 in.) chart size

7132A: Long-term unattended operation, disposable ink or thermal writing system, two pens, 11 input ranges, 8 speeds.

7133A: Similar to 7132A but with one pen.

OEM application strip chart recorders: Single-span strip chart recorders offer an economic choice necessary for dedicated OEM applications.

7130A: 25 cm (10 in.) chart size, 50 options available, 11 available input range spans, two pens, disposable ink or thermal writing system.

7131A: Similar to 7130A but with one pen.

Review of HP's Oscillograph Recorders

Hewlett-Packard oscillographic recorders are designed to free you from pen adjustment, lapping, and replacement problems through a combination of tungsten or ceramic tips and trouble-free mechanical design. The recorders provide single high resonant frequency, consistent and uniform traces, and smooth, controlled pen response. Other features include remote chart speed control, accessible preamplifier outputs, and common shielded input connectors on all preamplifiers.

7402A: Two channel direct writing recorder capable of recording signals from DC through 150 Hz. A choice of plug-in signal conditioners provides user flexibility for configuring the recorder for specialized requirements.

7404A: Similar to 7402 except with four channels.

7414A: Similar to 7402 except with four channels and a thermal writing system.

7418A: Similar to 7402 except with eight channels and a thermal writing system.



RECORDERS & PRINTERS

Low-cost, Flexible X-Y Recorders

Models 7010B, 7015B

- Low cost of ownership
- Choice of optional features

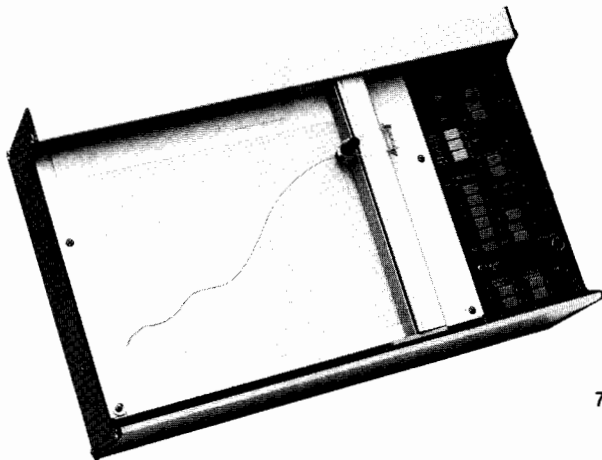

- Low price
- Full capability

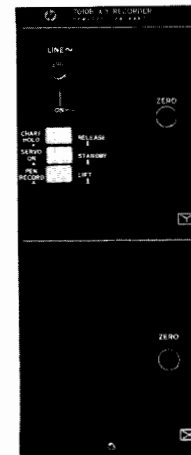

7015B

7010B
Control
Panel

Models 7010B and 7015B X-Y Recorders

The 7010B and 7015B are low-cost, one pen X-Y recorders that allow charting on paper sizes up to ISO A4 or 216 x 280 mm (8½ x 11 in.). All paper sizes, up to the maximum, are held securely by the trouble-free electrostatic paper hold down. The units are mounted in sturdy cases made from single castings, assuring mechanical alignment and long life, even in rugged environments. Designed for the OEM market, the 7010B recorder features low cost, compact design, and a selection of options. The 7015B provides recording for a wide range of laboratory uses where there is a need for full capability at reasonable cost.

The 7010B for OEM applications, features electrical and mechanical flexibility by providing a choice of X- and Y-axis sensitivities and X-axis sweep options. In addition, there are optional time base sweeps with remote TTL triggering, input filters, electric pen lift with TTL remote control, control panel, and carrying case.

The 7015B is a low-cost recorder with a full complement of capabilities. The standard features include an internal time base with sweep selections from 5 seconds to 20 minutes. The time base provides automatic pen control and accepts remote triggering from sweep start and reset. Also included are matched input filters; remote pen lift; and TTL-level remote control. The 7015B accepts TTL-level and low current (5 mA) contact closure for easy interface with external equipment.

7010B, 7015B Performance Specifications

Input voltage:

7010B: Single range, 0.1 V/in. (metric Opt: 50 mV/cm)

7015B: Metric options: 5 mV/cm, 50 mV/cm, 500 mV/cm

English: 0.01 V/in., 0.1 V/in., 1 V/in. Vernier adjustable overlapping all ranges

Time base:

7015B: 0.5, 1, 5, 10, 50, 100 s/in. (Option 001, metric calibration is 0.1, 0.5, 1, 5, 10, 50, s/cm). Remote sweep start and reset via TTL level or contact closure.

Input types:

7010B: Floating rear connector on circuit board

7015B: Floating binding posts or circuit board rear connector

Input resistance: 1 MΩ constant.

Normal mode rejection: 7015B: greater than 50 dB at 50 and 60 Hz (40 dB/decade roll-off above 60 Hz)

Common mode rejection: 100 dB DC, 90 dB AC (decreases 20 dB/decade step in attenuation). Measured with 1K unbalance in HI terminal on most sensitive range

Common mode voltage: 70V DC and peak AC maximum (conforms to IEC 348)

Accuracy: 7010B: $\pm 0.3\%$ of full scale at 25°C (includes linearity and resettability). 7015B: Add $\pm 0.2\%$ of deflection when not on most sensitive range. Temperature coefficient: $\pm 0.2\%/^{\circ}\text{C}$. Time base: $1.5\% \pm 0.1\%/^{\circ}\text{C}$

Resettability: Less than 0.2% of full scale.

Overshoot: Less than 2% of full scale.

Slewing speed: Greater than 50 cm/s (20 in./s).

Zero set: 7015B: Zero may be placed anywhere on writing area or electrically off-scale up to one full scale from zero index. Adjustment by 10-turn high resolution control.

Environment: Operating temperature 0°C to 55°C; relative humidity 95% RH to 40°C.

7010B, 7015B General Specifications

Writing system: Fiber tipped disposable pen.

Writing area: 18 x 25 cm (7 x 10 in.)

Platen size: Holds up to ISO A4 (21 x 30 cm) and 8½ x 11 in.

Size: 267 H x 432 W x 135 mm D (10½ x 17 x 5 in.) Electrostatic paper hold down: ISO A4 chart size or less

Pen lift:

7010B: Manual (optional TTL remote control)

7015B: Electric (remote via TTL level or contact closure)

Power: Switch selectable for 100, 120, 220, 240 V AC +5 -10%; 47.5 to 440 Hz; 70 VA maximum.

Weight: Net, 7.2 kg (16 lb). Shipping 10 kg (22 lb)

7010B Options

001 Metric Calibration

002 Control Panel

003 Electric pen lift

004 Deletes recorder case

005 X-axis single sensitivity 5 mV/cm (10 mV/in.)

006 X-axis single sensitivity 0.5 V/cm (1 V/in.)

007 Y-axis single sensitivity 5 mV/cm (10 mV/in.)

008 Y-axis single sensitivity 0.5 V/cm (1 V/in.)

009* X-axis sweep rate of 0.5 s/cm (1 s/in.)

010* X-axis sweep rate of 5 s/cm (10 s/in.)

011 Carrying case (not for shipping use)

012 Input filter (both axes)

013 Rear connector (37-pin subminiature "D")

908 Rack mount

*Options 009 and 010 include electric pen lift

Price

N/C

\$110

\$100

N/C

N/C

N/C

N/C

\$130

\$130

\$155

\$65

\$100

\$25

7015B Options

001 Metric calibration

004 Carrying case (not for shipping use)

908 Rack mount

Price

N/C

\$150

\$25

Ordering Information

7010B OEM X-Y Recorder

7015B Lab X-Y Recorder

OEM discounts available

Price

\$1475

\$1800

- Precision recording
- Time base available
- Floating guarded inputs

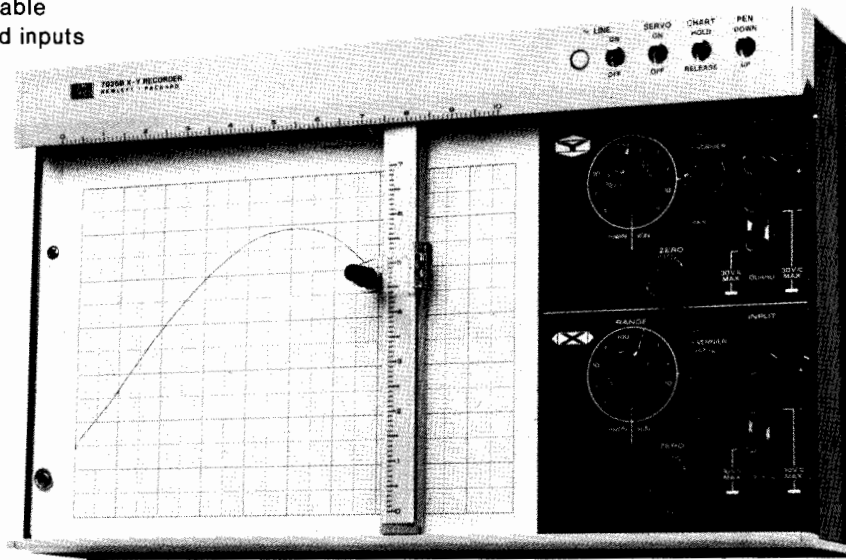

7035B

Model 7035B X-Y Recorder

The 7035B combines precision with low cost and general-use design to provide users with one X-Y recorder that serves most recording needs where high dynamic performance is not a requirement. Compact in design, the 7035B is well adapted to rack mounting with the addition of only two optional wing brackets. Other features are silent, trouble-free electrostatic paper hold down for paper sizes up to 216 x 280 mm (8½ x 11 in.); floating guarded inputs to help eliminate the common mode voltage effects that are troublesome when recording from low level sources; and disposable pens with self-contained ink supply to allow simple, one-step replacement of ink, tip, and color.

Input connectors on the 7035B accept both open wire and plug-type connectors. In addition, the recorder provides five calibrated ranges (0.4 mV/cm to 4 V/cm) for each axis; signal scaling for full-scale deflection, and high input impedance (1 megohm, except the first two ranges).

Model 17108A Time Base

The 17108A is a self-contained external time base that operates on either axis of the 7035B. By simply plugging in the 17108A, the 7035B is provided with five sweep speeds from 0.2 to 20 s/cm (0.5 to 50 s/in.). This module, powered by a single self-contained battery, is controlled by its own six-position range switch and three-position mode switch.



17108A Option 001 mounted on recorder

17108A Specifications

Sweep speeds: 0.2, 0.4, 2, 4, 20 s/cm (0.5, 1, 5, 10, 50 s/in.)
Accuracy: 5% of recorder full scale
Linearity: 0.5% of full scale (20°C to 30°C)
Output voltage: 0 to 1.5 V
Power: Replaceable mercury battery (100 hr)

7035B Performance Specifications

Input ranges: 0.4, 4, 40, 400 mV/cm and 4 V/cm (1, 10, 100 mV/in.; 1 and 10 V/in.). Continuous vernier between ranges
Input types: Floating guarded signal pair; rear connector
Input resistance:

Range	Input resistance
0.4 mV/cm Variable (1 mV/in.)	Potentiometric (essentially infinite at null) 11 KΩ
4 mV/cm Variable (10 mV/in.)	100 KΩ 100 KΩ
40 mV/cm & above (100 mV/in.) & above	1 MΩ

Normal mode rejection: >30 dB at 60 Hz; then 18 dB/octave

Maximum allowable source impedance: No restrictions except on fixed 0.4 mV/cm (1 mV/in.) range. Up to 20 kΩ source impedance will not alter recorder's performance.

Accuracy: ±0.2% of full scale

Linearity: ±0.1% of full scale

Resettability: ±0.1% of full scale

Zero set: Zero may be set up to one full scale in any direction from zero index. Lockable zero controls.

Slewing speed: 50 cm/s (20 in./s) nominal at 115 V.

Common mode rejection: 130 dB at DC & 100 dB at line frequency with up to 1 kΩ between the positive input and guard connection point and attenuator on most sensitive range. CMR decreased 20 dB per decade step in attenuation.

7035B General Specifications

Electrostatic paper hold down: Grips 216 x 280 mm (8½ x 11 in.) charts or smaller. Special paper not required.

Pen lift: Electric pen lift capable of being remotely controlled.

Size: 265 H x 445 W x 121 mm D (10-7/16 x 17½ x 4¾ in.)

Weight: Net, 8 kg (18 lb). Shipping, 10.9 kg (24 lb).

Power: 115 or 230 V ±10%, 50 to 60 Hz, approximately 45 VA

7035B Options

001 Metric calibration Price N/C
003 Retransmitting potentiometer on X-axis 5kΩ ± 3% \$125

17108A Options

002 17108A Metric calibration N/C

Ordering Information

7035B General purpose X-Y recorder Price \$2000
17108A Time base plug-in \$400

RECORDERS & PRINTERS

High Performance General-Use X-Y Recorders

Models 7044B, 7045B, 7046B, 7047A

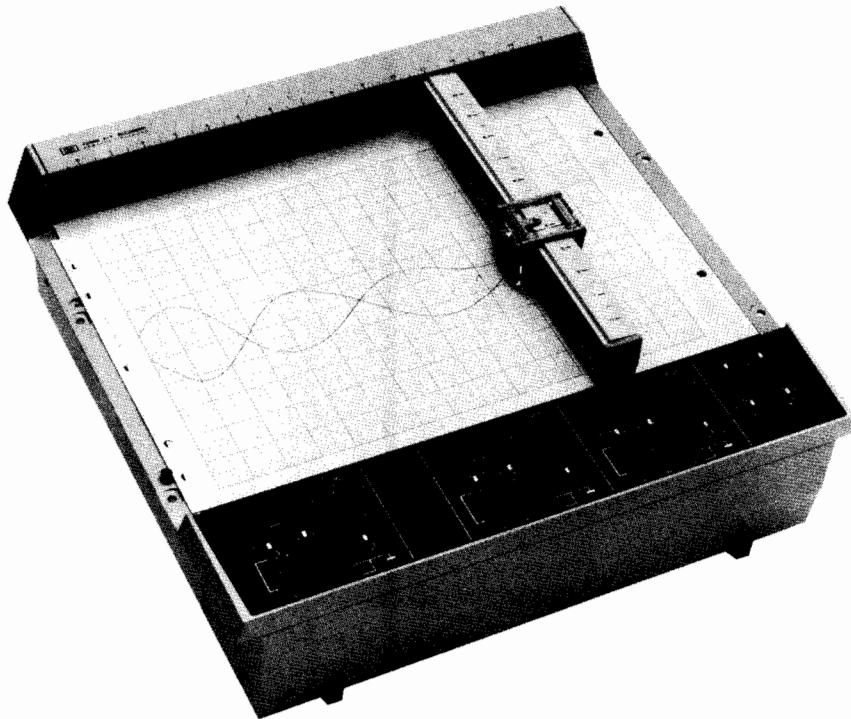

Maximum general-use capability need? Two pens to draw two or three simultaneous variables? . . . **Choose the 7046B**



Relatively low frequency requirements? A dedicated application? Flexible needs for basic recording? . . . **Choose the 7044B**

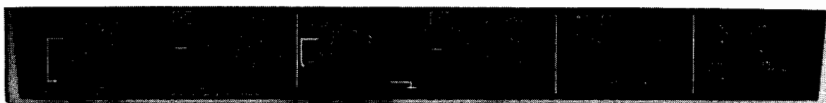

Multi-users and many applications? Fast pen response? No need to plot two simultaneous Y variables? . . . **Choose the 7045B**



High sensitivity low signal application, such as electrochemistry? High noise levels? . . . **Choose the 7047A**

The 7044B, 7045B, 7046B, 7047A

This series of general-use X-Y recorders has been designed to satisfy both current and future laboratory applications. The high-level performance and reliability of these recorders are the results of a design philosophy that has evolved through 30 years of Hewlett-Packard experience as a leading manufacturer of X-Y recorders.

Whether the buyer purchases the one-pen (X or T vs Y) 7044B, 7045B or 7047A or the two pen (X or T vs Y1 & Y2) 7046B, the recorder will provide the following quality features:

Very high dynamic performance: With a combination of high slewing speed and acceleration, these recorders can capture fast changing signals that an ordinary recorder might miss. For example, the 7045B will, typically, record a signal from DC to 10 Hz at 2 cm peak-to-peak amplitude on either axis.

TTL remote control: With TTL or simple contact closure to ground, a rear connector offers easy interface to measurement systems. TTL provides remote control of sweep start and reset, pen lift, servo mute, and chart hold. Pen lift, the most important action to be controlled remotely, is also available from a convenient rear-mounted banana jack connector (not 7047A).

Wide chart size range: Accepts ISO A3, ISO A4, 8½ x 11 in., 11 x 17 in. and, in fact, virtually any paper size under the maximum limit (ISO A3 or 11 x 17 in.). With this capability these recorders can fill a greatly increased variety of charting needs.

Environmental specifications: Each unit is designed to meet exacting Hewlett-Packard environmental specifications. For example, units are designed to meet performance specifications over a temperature range of 0°C to 55°C; 95% relative humidity at 40°C; plus rugged shock and vibration specifications.

Other user-oriented features: With this X-Y recorder line, the two main design objectives were to produce precision instruments and to make these units easy to use. Some of the major designed-in features to achieve these objectives are:

- Polarity reverse switch that eliminates need to reverse input leads
- Response switch on 7045B and 7046B that allows recorder response to be slowed to simplify initial set up
- Separate rear connector that provides a convenient remote pen lift control connection (not 7047A)
- Built-in hardware that simplifies table or rack mounting



7044B, 7045B, 7046B, and 7047A Specifications

Performance Specifications

	7044B HIGH SPEED	7045B VERY HIGH SPEED	7046B 2-PEN, VERY HIGH SPEED	7047A VERY HIGH SENSITIVITY
Type of input	Front and rear input. Floating, guarded. Polarity reversal switch on front panel.			Front input only. Floating, guarded. Common mode driver circuit eliminates need to connect CMV to recorder, if CMV < 10 V peak.
Input ranges	0.25, 0.5, 1, 2.5, 5, 10, 25, 50, 100, 250, 500 mV/cm. 1, 2.5, 5 V/cm. (0.5, 1, 2, 5, 10, 20, 50, 100, 200, 500 mV/in. 1, 2, 5, 10 V/in.) Continuous vernier between ranges.			0.05, 0.1, 0.5, 1, 5, 10 mV/in.; 0.05, 0.1, 0.5, 1.5, 10 V/in. (metric available in 0.02, 0.05, 0.1, 0.5, 1, 5 mV/cm; 0.01, 0.05, 0.1, 0.5, 1, 5 V/cm). Continuous vernier between ranges.
Input resistance	1 megohm constant on all ranges			
Source resistance	10 k ohm maximum on all ranges			10 k ohm max except 0.02 mV/cm, 0.05 mV/cm, and 0.1 mV/cm (0.05 mV/in. and 0.1 mV/in.) ranges are 2 k ohm max.
Accuracy	±0.2% of full scale (includes linearity and deadband) at 25°C. Temp coefficient ±0.01% per °C			
Range accuracy	±0.2% of full scale ±0.2% of deflection (includes linearity and deadband) at 25°C. Temp coefficient ±0.01% per °C.			
Deadband	0.1% of full scale			
Common mode rejection	110 dB and 90 dB AC (exceeds 130 dB DC and 110 dB AC under normal lab environmental conditions) with 1 k ohm between HI and LO terminals. CMV applied between ground and LO, and attenuator on most sensitive range. CMR decreases 20 dB per decade step in attenuation.			130 dB DC and 130 dB AC with 1 k ohm imbalance in HI or LO terminal (exceeds 150 dB under normal conditions). CMR decreases 20 dB per decade step in attenuation from most sensitive range.
Normal mode rejection	Internal filter not available			30 dB min at line frequency with FILTER IN. (50 dB typical at 60 Hz and 40 dB at 50 Hz.)

Dynamic Performance Specifications

Slewing speed	50 cm/s (20 in./s), min.	97 cm/s (38 in./s) typical under normal lab conditions. 76 cm/s (30 in./s) minimum.		
Acceleration peak—Y axis	2540 cm/s ² (1000 in./s ²)	7620 cm/s ² (3000 in./s ²)	6350 cm/s ² (2500 in./s ²)	7620 cm/s ² (3000 in./s ²)
—X axis	1270 cm/s ² (500 in./s ²)	5080 cm/s ² (2000 in./s ²)	3800 cm/s ² (1500 in./s ²)	5080 cm/s ² (2000 in./s ²)
Overshoot	2% of full scale maximum.	1% of full scale maximum.		

Offset Specifications

Zero offset	Zero may be placed anywhere on the writing area or electrically off scale up to one full scale from zero index.	11 calibrated scales of zero offset in both axes. Switchable in steps of full scale from +1 to -10.		
Offset accuracy at 25°C (applies to calibrated unit)	Not applicable	±0.1% of full scale times N where N = number of scales of offset.		
Temperature coefficient	Not applicable	±0.004% of full scale times N per °C.		

Time Base Specifications

Time base	8 speeds: 0.25, 0.5, 1, 2, 5, 10, 25, 50 s/cm (0.5, 1, 2, 5, 10, 20, 50, 100 s/in.)	6 speeds: 0.1, 0.5, 1, 5, 10, 50 s/cm (English is 0.5, 1, 5, 10, 50, 100 s/in. switchable to X or Y axis.		
Time base accuracy	1.0% at 25°C. Temp coefficient at ±0.1%/C°			

General Specifications

Power	100, 120, 220, 240 Vac +5 -10%; 48 to 440 Hz; 135 VA	100, 120, 220, 240 Vac +5 -10%; 48 to 440 Hz; 230 VA	100, 120, 220, 240 Vac +5 -10%; 48 to 440 Hz; 230 VA	100, 120, 220, 240 Vac +5, -10%; 48 to 66 Hz; 180 VA
Pen lift	Electric (remote via TTL level)			
Writing area	25 x 38 cm (10 x 15 in.)			
Weight	Net 13.7 kg (30 lb)		Net 16 kg (35 lb)	Net 18.6 kg (41 lb)
Size	400 H x 483 W x 165 mm D (15½ x 19 x 6½ in.)			

7044B, 7045B Options

001 Time Base	Price \$290
002 Event marker	\$140
006 Metric calibration	N/C

7047A Options

001 Metric calibration	Price N/C
002 Event marker	\$140

7046B Options

001 Time base	Price \$290
002 Event marker	\$140
007 Metric calibration	N/C
085 VDE certification (VDE specification DIN 57411)	\$85

Ordering Information

7044B High speed recorder	Price \$2750
7045B Very high speed recorder	\$3150
7046B 2-pen, very high speed recorder	\$4550
7047A Very high sensitivity, high speed recorder	\$4800
OEM discounts available	



RECORDERS & PRINTERS

High Performance Modular X-Y Recorders

Models 7034A, 7004B, with 17170 Series Preamps

- High dynamic performance
- Plug-in flexibility
- Guarded inputs

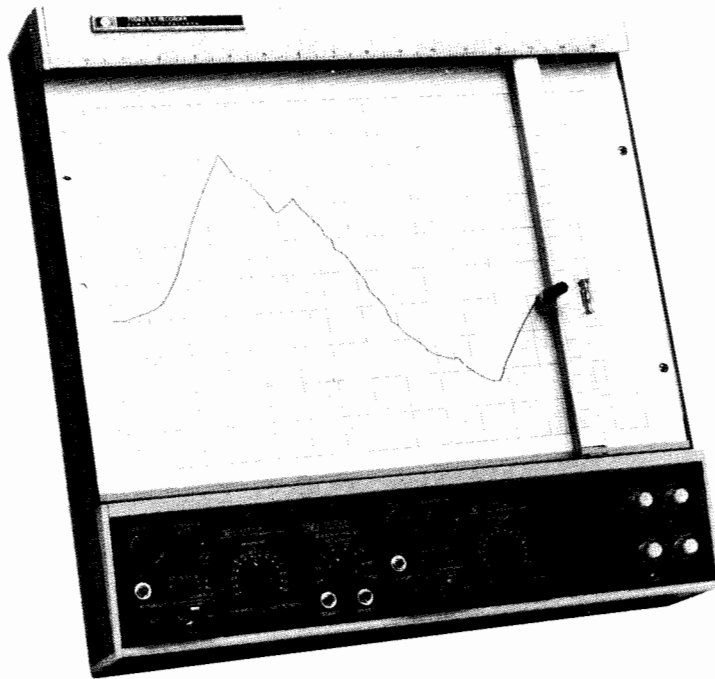

7004B

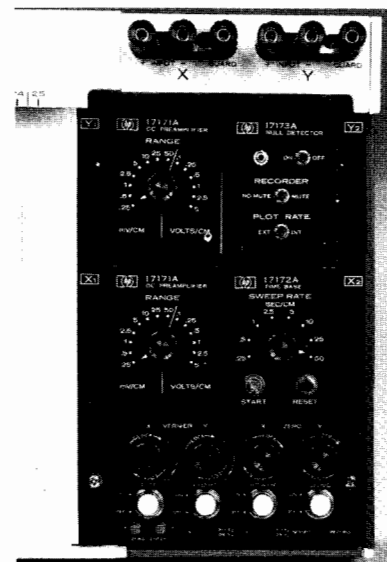

7034A

Models 7034A and 7004B X-Y Recorders

The 7034A and 7004B X-Y recorders provide high dynamic performance, plus plug-in flexibility. Precision recordings of rapidly changing input signals are assured, because the recorders have excellent dynamic performance, high slewing speed (greater than 75 cm/s), and high peak acceleration (3800 cm/s²). With this high peak acceleration, the pen can follow quick, small input changes, accelerating to 76 cm/s in less than 50 ms.

Both the 7034A and 7004B can be user reconfigured for many different recording needs by simply plugging in different preamp modules. The variety of signal conditioner modules now available permits the user to reconfigure the recorder not only for a specific purpose, but also to reconfigure the recorder to one of these three basic types:

- **Basic systems recorder**—50 mV/cm (100 mV/in.). Available with DC coupler (17170A).
- **General-purpose recorder**—High-sensitivity X-Y available with DC preamps (17171A). Can have X-T or Y-T, available with DC (17171A), plus time base (17172A).
- **Specialized recorder**—Point plotting available with null detector (17173A) and “two-pen” simulation available with scanner (17176A).

In addition, other features may be added with other modules.

The 7034A, 7004B Offer Many Features

The 7034A and 7004B have front and rear guard terminals available for signal inputs. This guarding helps eliminate the common mode voltage effects that are particularly troublesome when recording from low level sources, such as thermocouples and strain gauges. In addition, the recorders are equipped with a silent, trouble-free electrostatic hold down that secures all paper sizes up to 210 x 280 mm (8½ x 11 in.) on the 7034A and 280 x 432 mm (11 x 17 in.) on the 7004B. Disposable ink pens are designed to provide clean, crisp, and continuous traces; while their self-contained ink supplies and fiber

tips eliminate ink handling and pen cleaning. Other features include a Record/Setup switch, single-locking rear connector, easily accessible slidewires, knob locks, five-way binding posts, locking feet, tilt stand, and optional rack mounting brackets.

Model 17012B/C Point Plotter

The 7004B or 7034A, equipped with 17012B or 17012C respectively, point plot when used with appropriate plug-in. Plotting rate is 50 points per second. Power is supplied from recorder.

7034A and 7004B Performance Specifications

Plug-ins: Accept 4 single-width, 2 per axis

Type of input: Floating and guarded signal pair. Available through front panel or rear connector.

Zero set: May be set ± 1 fs from zero index

Zero check switches: pushbutton in each axis allows verification of recorder's zero position without removal or shorting of input signal.

Mainframe accuracy: $\pm 0.2\%$ of full scale

Range vernier: Lockable, covers 2.5 times range setting

Slewing speed: More than 75 cm/s (30 in./s) independent of line voltage and frequency

Acceleration (peak): More than 3800 cm/s² (4 G)

Reference stability: Better than 0.003%/°C

Terminal-based linearity: $\pm 0.1\%$ of full scale

Resettability: $\pm 0.05\%$ of full scale

7034A, 7004B General Specifications

Electrostatic paper hold down: Grips charts up to size of platen

Pen lift: Local and remote control (contact closure or TTL)

Size:

7004B: 445 H x 445 W x 121 mm D (17½ x 17½ x 4¾ in.)

7034A: 267 H x 445 W x 121 mm D (10½ x 17½ x 4¾ in.)

Weight:

7004B: Net 10.9 kg (24 lb). Shipping 14.5 kg (32 lb)

7034A: Net 7.7 kg (17 lb). Shipping 10.2 kg (23 lb)

Power: 115 or 230 V AC $\pm 10\%$, 50 to 400 Hz, approximately 85 VA (dependent on plug-in)

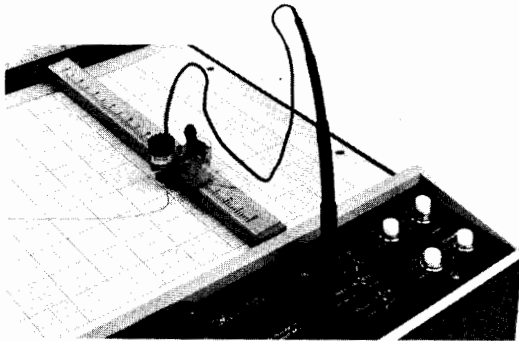

17012B/C

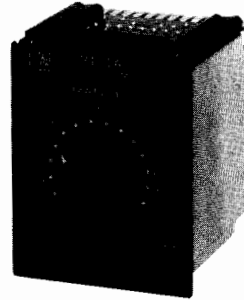

17171A

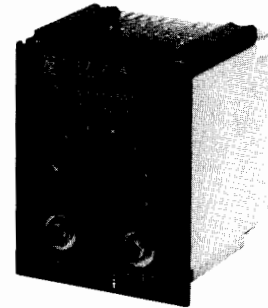

17172A

17170 Series Preamp Specifications

17170A DC Coupler

Input range: Single, fixed calibration range of 50 mV/cm (100 mV/in.)

Input resistance: 1 MΩ constant

Common mode rejection: 120 dB at DC & 70 dB at 50 Hz & above with 100Ω between low side & guard connect point with source impedance 10 kΩ or less

17171A DC Preamplifier

Input ranges: 0.25, 0.5, 1, 2.5, 5, 10, 25 mV/cm, 0.05, 0.1, 0.25, 0.5, 1, 2.5, 5 V/cm (0.5, 1, 2, 5, 10, 20, 50, mV/in., 0.1, 0.2, 0.5, 1, 2, 5, 10 V/in.)

Input resistance: 1 MΩ

Common mode rejection: 120 dB at DC & 100 dB at 50 Hz & above with 100Ω between low side & guard connect point at 0.25 mV/cm (0.5 mV/in.). CMR on others decreases 20 dB/decade step in attenuation.

System accuracy: ±0.2% full scale

17172A Time Base

Sweep speeds: 0.25, 0.5, 1, 2.5, 5, 10, 25, 50 s/cm (0.5, 1, 2, 5, 10, 20, 50 100 s/in.)

System accuracy: ±1% of fs on 6 fastest ranges, ±2.5% on remaining two

17173A Null Detector (17012B/C Required)

Plot rate: Up to 50 plots/s

Enable/disable: Required disable voltage +3 V min to +20 V max

Required enable voltage: -0 V DC or no connect. Other voltage combinations available on request

Muting: Local or remote

Plotting accuracy: ±0.25% of full scale

17174B DC Offset

Offset: <1 mV to approximately 1 V

Controls: 2 lockable, 10-T high resolution controls (<1 mV to approximately 10 mV & <1 mV to approximately 1 V). An offset polarity switch allows upscale or downscale zero offset

Offset voltage stability: >0.005%/°C

17175A Filter

Input ranges: -5 to +45 V DC, 10 V AC max p-p

Maximum source impedance: 1 kΩ; higher impedance decreases filter response

Rejection: >55 dB at 50 Hz & higher (¼ s rise time) or >70 dB at 50 Hz & higher (1 s rise time). Front panel selection

17176A Scanner (17012B/C Required)

Input: Front panel miniature binding posts isolated from ground (high & low only). Mainframe input: Utilizes existing input connectors

Attenuator: Fixed attenuator in decade steps from X1 to X0.001. Variable attenuator provides continuous coverage

Input impedance: 100 kΩ

Accuracy: 0.2% of full scale

Scan Rate: Adjustable from 0.1 to 4 s/scan

17178A DC Attenuator

Input ranges: 0.05, 0.1, 0.25, 0.5, 1, 2.5, 5, 10 V/cm (0.1, 0.2, 0.5, 1, 2.5, 10, 20 V/in.)

Input resistance: 1 MΩ

Common mode rejection: 120 dB at DC & 70 dB at 50 Hz & above with 100Ω between low side & point where guard is connected (at 50 mV/cm or 100 mV/in.). Other ranges CMR decreases 20 dB/decade step in attenuation.

System accuracy: ±0.2% of full scale

7004B Options

001 Metric scaling and calibration

002 X-axis retransmitting potentiometer 5 kΩ ±0.1% linearity

908 Rack mount kit

7034A Options

001 Metric scaling and calibration

908 Rack mount kit

17012B/C Point Plotter Options

001 6-symbol plotting capability

17171, 17172, 17177, 17178 Options

001 Metric scaling

17173A Preamp Options

001 +3 to 20 V enable, 0 V disable

002 -3 to -20 V disable, 0 V enable

003 -3 to -20 V enable, 0 V disable

Ordering Information

7004B X-Y recorder

7034A X-Y recorder

17170A DC coupler plug-in

17171A DC amplifier plug-in

17172A Time base plug-in

17173A Null detector

17174B DC offset plug-in

17175A Filter plug-in

17176A Scanner plug-in

17178A DC attenuator plug-in

17012B/C Point plotter

Price

N/C

\$135

\$35

\$35

\$30

Price

N/C

\$100

Price

N/C

Price

\$35

\$35

\$35

Price

\$2900

\$2800

\$100

\$550

\$450

\$600

\$350

\$300

\$800

\$300

\$350

RECORDERS & PRINTERS

Compact, Wide-Range Strip Chart Recorder

Model 680

- Low-cost, high quality recording
- User-selectable speeds and spans
- Metric or English recording
- Compact design

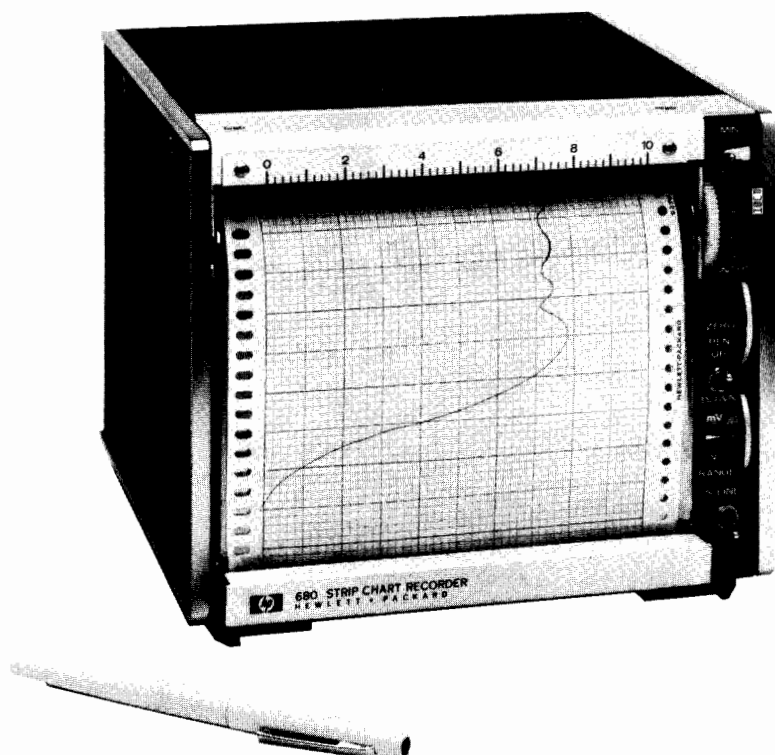

680

Model 680 Strip Chart Recorder

The compact 680 produces quality recordings on a 12 cm or 5 in. wide grid. The versatility of the 680 is demonstrated by the wide range of user-selectable speeds and spans, providing one small unit that fills many metric or English recording needs. Major areas of versatility include ten selectable voltage spans from 6 mV to 120 V (5 mV to 100 V for English recording) to magnify specific data; eight selectable speeds from 2.5 cm/hr to 20 cm/min (1 in./hr to 8 in./min for English recording) to use the most compatible speed with the data input rate; and two ink writing systems to provide a steel pen for maximum durability or optional disposable fiber and capillary tips to help prevent possible clogging, due to noisy data. The 680 also provides a remote electric pen lift, full-scale zero adjustment, and standard input filter to eliminate the effects of signal noise. Primary uses of the 680 are as a monitor for instrumentation with DC outputs and for digital devices using digital-to-analog converters.

680 Performance Specifications

Spans: Ten calibrated spans; Metric—6, 12, 60, 120, 600 mV; 1, 2, 6, 12, 60, 120 V (English—5, 10, 50, 100, 500 mV; 1, 5, 10, 50, 100 V)

Input type: Floating; rear panel connector

Maximum DC common mode voltage: 500 V

Input resistance: 166 k Ω /V (200 k Ω /V, English) full scale, through 10 V span; 2 M Ω on all others.

Common mode rejection: DC 100 dB on most sensitive range. Decreases 20 dB per decade step in attenuation

Accuracy: $\pm 0.2\%$ of full scale

Response time: Maximum, 0.5 s full scale

Resettability: 0.1% of full scale

Chart speed: Synchronous motor driver; metric—2.5, 5, 10, 20 cm/min; 2.5, 5, 10, 20 cm/hr (English—1, 2, 4, 8 in./min and in./hr). Option 008, gear ratio 16/1 instead of 60/1 speeds— $1/16$, $1/8$, $1/4$, $1/2$, 1, 2, 4, 8 in./min

Zero set: Adjustable over full span

680 General Specifications

Writing mechanism: Ink

Pen lift: Electric, controlled by local switch or remote contact closure

Power: 115/230 V, 60 Hz, 22 VA

Weight: Net, 5 kg (11 lb); shipping 7.6 kg (17 lb)

Size: 165 H x 197 W x 219 mm D (6 $\frac{1}{2}$ x 7 $\frac{3}{4}$ x 8 $\frac{3}{8}$ in.)

680 Options

001 Retransmitting potentiometer

002 Event marker

003 High-low limit switches

008 16/1 speed reducer (replaces 60/1)

009 Remote chart on-off

010 50 Hz operation

014 Glass door with lock

018 Disposable pen tips

026 Metric calibration

H01 Additional span: 1 mV English, 1.2 mV metric

H02 100k input resistance

Price

\$150

\$120

\$275

\$85

\$65

N/C

\$240

N/C

N/C

\$110

\$160

Ordering Information

680 Strip chart recorder

OEM discounts available

Price

\$2150

RECORDERS & PRINTERS

Dedicated Strip Chart Recorder

Models 7130A, 7131A



- Economical models for OEM use
- Disposable pens or thermal writing option

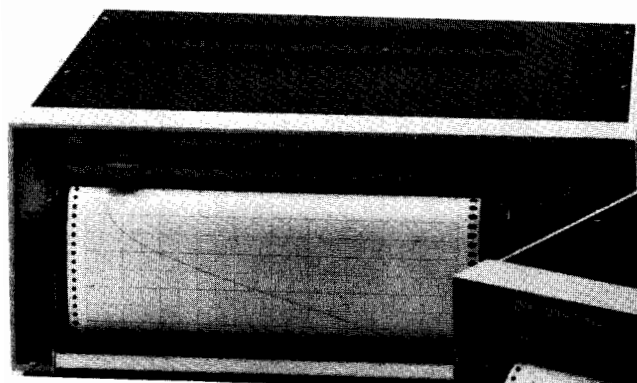

7131A

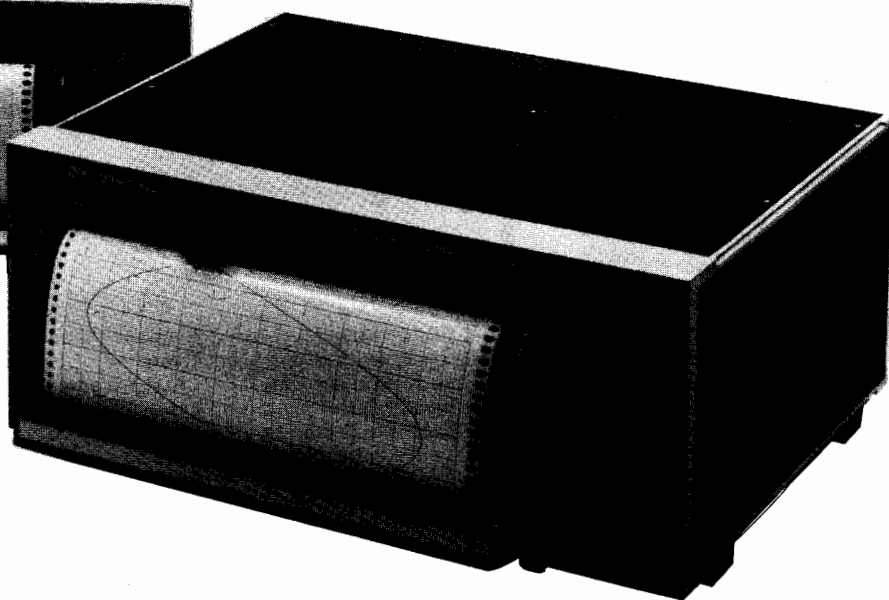

7130A

Model 7130A, 7131A Strip Chart Recorders

The two-pen 7130A and one-pen 7131A are 25 cm or 10-inch strip chart recorders designed primarily for the OEM market. Providing an unusually large range of voltage span and chart speed options, these units are designed with the ruggedness, compactness, and performance required by OEM users.

7130A, 7131A Performance Specifications

Input ranges: Single span, 1 mV through 100 V (specified by option)

Input type: Single ended, floating

Maximum allowable source resistance (Rs): 10 k Ω

Normal mode rejection (at line frequency): >40 dB

Common mode rejection: >120 dB at DC and >100 dB at line frequency

Response time: <1/2 s

Overshoot: <2% of full scale

Accuracy (including linearity and deadband): $\pm 0.2\%$ of full scale at 25°C

Deadband: $\pm 0.1\%$ of full scale

Chart speeds: Speed from 15 cm/min to 3 cm/hr (6 in./min to 1 in./hr) determined by option choice. Two 4-speed and two 8-speed options are available, as well as 60:1, 10:1, 4:1 and 2:1 speed reducers

Chart speed accuracy: $\pm 0.08\%$ plus line frequency accuracy

Zero set: Left hand, adjustable ± 1 full scale

Environmental (operation): 0°C to 55°C, 95% RH (40°C)

7130A, 7131A General Specifications

Writing mechanism: Disposable ink pens (thermal writing optional)

Grid width: 25 cm or 10 in.

Chart length: 27 m or 90 ft

Pen lift: Manual (electric or independent optional)

Size: 178 H x 432 W x 340 mm D (7 x 17 x 13 3/8 in.)

Power: 115/230 V $\pm 10\%$, 50 or 60 Hz, 120 VA

Weight: Net, 12.3 kg (27 lb). Shipping 17.4 kg (38 lb)

7130A, 7131A Options

A large number of options are available for the 7130A and 7131A strip chart recorders. For a detailed list, contact your HP sales representative.

Ordering Information

Must order: Span, chart speed, and Option 050 (50 Hz) or 060 (60 Hz). Specify one span for each channel; spans may be different. English or metric chart speed determines front scale. Price does not include required options.

7130A Two-pen recorder
7131A One-pen recorder
OEM discounts available

Price
\$2450
\$2000

RECORDERS & PRINTERS

Laboratory-use Strip Chart Recorders

Models 7132A, 7133A

- One-pen or two-pen recording
- Modular design
- Disposable pens or thermal writing
- User-selectable voltage spans

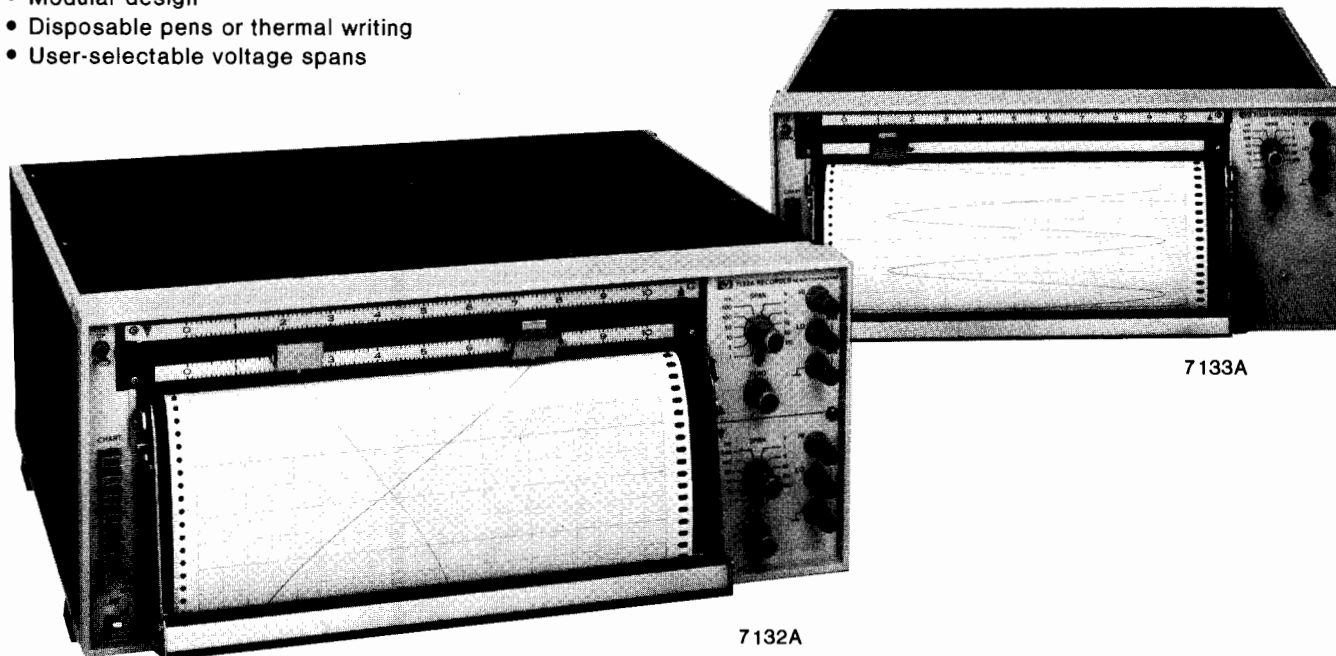

Models 7132A and 7133A Strip Chart Recorders

The two-pen 7132A and one-pen 7133A are designed with a stepper motor chart drive for sophisticated metric or English recording. This drive allows the chart advance to be controlled by an external pulse input, as well as by front-panel pushbuttons. When controlled by an external pulse, the chart speed is changed by variation in the rate at which pulses are applied to the motor; allowing the chart advance to be synchronized to an external event. Both recorders are manufactured with a belt-driven modular servo system for quiet, reliable operation. This modular design also helps cut maintenance costs by reducing the time necessary for routine inspections and maintenance. In addition, both recorders ensure significantly longer pen life by reducing the amplifier gain automatically if the pen is driven off scale.

The power of the 7132A and 7133A is demonstrated by features, such as 11 selectable voltage ranges with spans from 1 mV to 100 V in 1, 5, and 10 steps, plus front-panel control for overlapping span adjustment; 8 pushbutton selectable chart speeds from 15 cm/min to 2.5 cm/hr (6 in./min through 1 in./hr), plus external impulse control; and two writing systems, disposable ink pens or optional thermal writing for long-term, slow-speed, unattended operation. Thermal tips are designed with temperature sensing elements to maintain proper tip temperature for consistent trace quality.

Other options fill a variety of recording needs, such as right-hand zero (Option 014) to deflect the pen from right to left for recording positive voltage and event markers (Options 037, 038, and 537) to mark the position of important events on the right or left margin.

7132A, 7133A Performance Specifications

Input ranges: Eleven ranges from 1 mV to 100 V full scale in 1-5-10 sequence with overlapping vernier
Input type: Single ended, floating
Input resistance: 1 megohm on all ranges
Maximum source resistance: 10 kΩ (to within rated response)
Normal mode rejection (at line frequency): >40 dB
Common mode rejection: > 120 dB DC and 100 dB AC
Accuracy: ±0.2% of full scale (includes linearity and deadband) at 25°C. Temp coefficient ±0.01% per °C
Range accuracy: ±0.2% of full scale ±0.2% of deflection (includes linearity and deadband) at 25°C. Temp coefficient ±0.01% per °C
Deadband: 0.1% of full scale

Response time: Less than 0.5 second
Overshoot: Less than 2% of full scale
Chart speeds: 2.5, 5, 10, 15 cm/min, and cm/hr (1, 2, 4, 6 in./min, and in./hr)
Chart speed accuracy: ±0.08% plus line frequency accuracy
Zero set: Provides three full scales of offset
Environmental (operating): 0 to 55°C, less than 95% relative humidity (40°C)
Accessories and supplies: Request the HP Recorder Supplies Catalog from the local HP sales and service office.

7132A, 7133A General Specifications

Writing mechanism: Disposable ink pens (thermal writing optional)
Grid width: 25 cm (10 in.)
Chart length: 30 m (100 ft)
Pen lift: Solenoid operated with remote capabilities
Power: 115/230 V ±10%, 50 or 60 Hz, 120 VA
Size: 178 H x 432 W x 340 mm D (7 x 17 x 13.38 in.)
Weight: Net, 12.3 kg (27 lb). Shipping, 17.4 kg (38 lb)

7132A, 7133A Options

Option	Description	Price
001	Metric calibration	N/C
014	Right hand zero (hard)	N/C
037	Right hand event marker (not compatible with Option 054)	\$110
038	Thermal event marker (Option 054 required)	200
050	50 Hz line power	N/C
054	Thermal writing. (recommended for pen speed below 5 in./sec)	
	7132A	340
	7133A	245
060	60 Hz line power	N/C
537	7132A only. Left hand event marker (not available with thermal writing, Option 054)	110
908	Rack mounting brackets	25

Ordering Information

Model	Description	Price
7132A	Two-pen laboratory recorder	\$3100
7133A	One-pen laboratory recorder	\$2475

RECORDERS & PRINTERS

Portable Strip Chart Recorder

Model 7155B



- Portable recording
- Internal battery or line current operation

- Rugged construction for hostile environments
- 16 calibrated voltage spans and 7 speeds

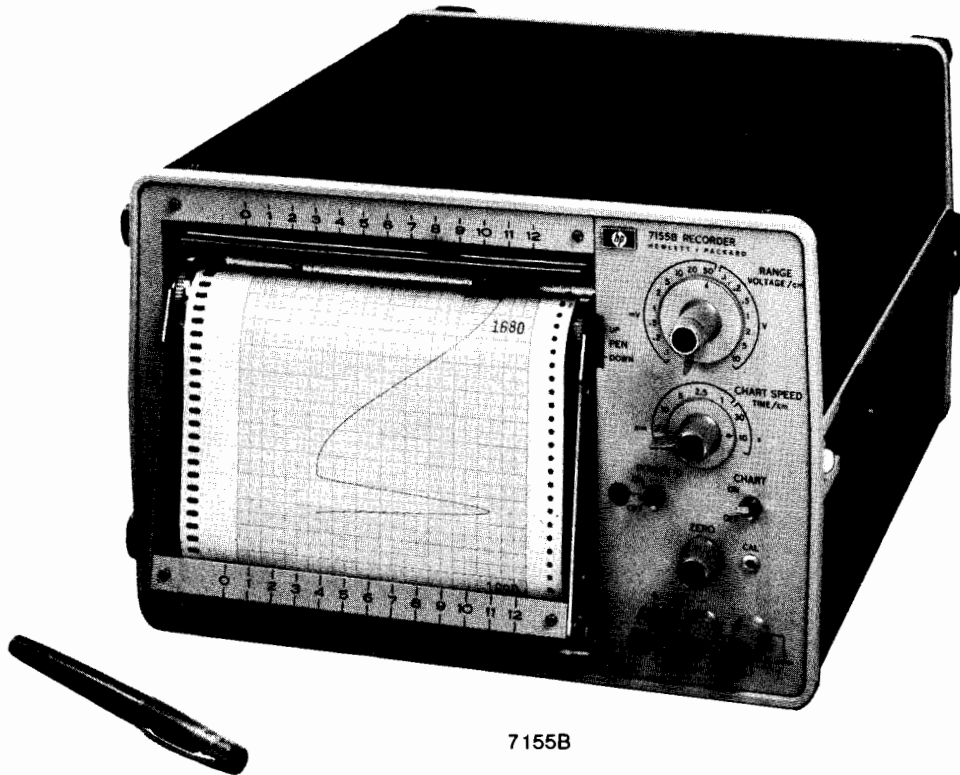

7155B

Model 7155B Portable Strip Chart Recorder

The portable 7155B metric strip chart recorder is both precise and rugged. Weighing only 14 kg (30 lb) with the optional internal batteries, the 7155B will record up to nine hours (at 25°C) on a 12 cm grid. Batteries can then be recharged with the built-in battery charger. The unit can also be run on external AC or DC or, with the batteries recharging, on external AC in the broad temperature range of -28°C to +65°C.

In addition to portability, this rugged metric recorder provides 16 calibrated voltage spans, so users can select spans from 0.1 mV/cm through 10 V/cm in a 1, 2, 5 sequence or additional spans using the overlapping vernier; seven chart speeds from 30 min/cm to 10 s/cm to select the best chart speed for the input; easy access to internal electronics for simplified servicing; three chart magazine tilt angles; and a snap-on plexiglas front cover to protect the unit from dust, dirt, and unwanted knob changes. The writing system includes disposable press-in pen-and-ink modules in two colors and coated paper to minimize heavy inking from slow traces and noisy data.

Several options are offered with the 7155B that extend its capabilities. These options include: Right-hand zero (Option 005) to provide pen deflection from right to left in order to record voltage; an event marker (Option 006) to note important events by marking the left edge of the paper; and an internal jellied electrolyte battery pack (Option 011) that operates up to nine hours at 25°C on a single charge. This battery pack can be recharged fully in approximately 14 hours.

7155B Performance Specifications

Input range: 0.1 mV/cm through 10 V/cm in a 1, 2, 5, sequence with overlapping vernier (12 cm full scale)
Input type: Single ended, floating
Input resistance: 1 megohm
Maximum allowable source resistance: 5k Ω for rated response
Common mode rejection: 100 dB DC and 80 dB AC

Full scale response time: 0.6 sec to within rate accuracy

Overshoot: 1% of full scale maximum

Accuracy: $\pm 0.4\%$ of full scale (includes linearity and deadband) at 25°C. Temp coefficient $\pm 0.1\%$ per °C

Range accuracy: $\pm 0.4\%$ of full scale $\pm 0.2\%$ of deflection (includes linearity and deadband at 25°C). Temp coefficient $\pm 0.01\%$ /°C

Chart speeds: 30, 10, 5, 2.5, 1 min/cm; 30 and 10 s/cm

Chart speed accuracy: $\pm 1\%$

Environmental (operating): -28°C to +65°C <95% relative humidity (40°C)

7155B General Specifications

Writing mechanism: Disposable ink pens

Grid width: 12 cm

Chart length: 21 metres (70 ft)

Pen lift: Mechanical

Weight: Net 14 kg (30 lb) with battery option installed

Size: 197 H x 304 W x 416 mm D (7 $\frac{3}{4}$ x 12 x 16 $\frac{3}{8}$ in.)

Power: External AC (48 to 440 Hz, 85 V to 130 V or 172 V to 260 V). External DC (10.5 to 34 V, 0.5 amp typical, 0.9 amp maximum independent of voltage)

7155B Options

005 Right hand zero

006 Event marker. Contact closure on rear panel causes approximately 0.06 cm (0.025 in.) deflection of event pen.

011 Internal batteries (shipped separately)

Ordering Information

7155B Portable Strip Chart Recorder
OEM discounts available

Price

N/C
\$195

\$90

Price

\$3150



RECORDERS & PRINTERS

Oscillographic Recorders with Plug-In Preamps

Models 7402A and 7404A with 17400A Series Preamps

- Records from DC to 150 Hz
- Draws traces with instant dry ink

- Provides pens designed for long-life use
- Allows configuration flexibility with plug-in modules



7402A
Option 005

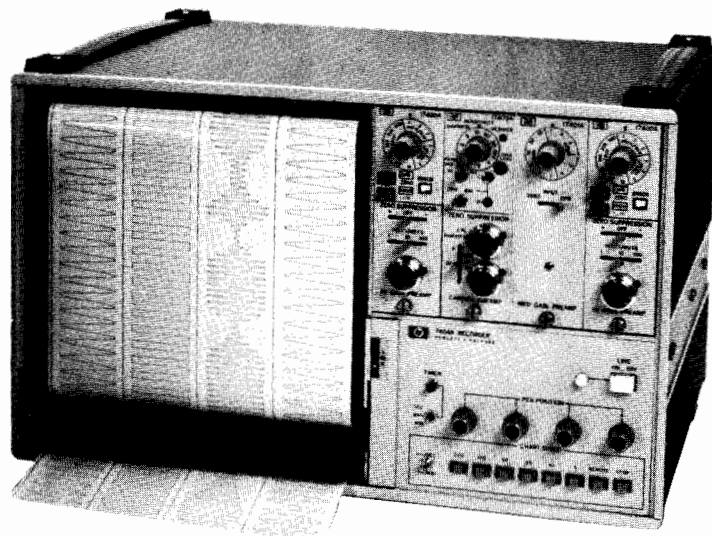

7404A

Models 7402A and 7404A Oscillographic Recorders

The 2-channel 7402A and 4-channel 7404A are direct writing oscillographic recorders capable of recording signals from DC through 150 Hz. Additional flexibility is provided with a choice of plug-in signal conditioner modules that can be changed easily by the user to configure the units to meet a variety of specific requirements.

Long-life Pens Provided

Both recorders are equipped with pens designed to last for the life of the recorder. The pen body is made of stainless steel to eliminate failure from metal fatigue, even when subjected to sustained and violent signals. The pen tips are formed of tungsten carbide, a metal with extremely low wear characteristics. The combination of durable metals in this HP pen design provides a stability that frees the user from tip lapping, pen adjustment, or replacement.

The low pressure ink system produces a solid black trace that dries as it draws. The consistency of the trace, even at high chart speed, provides a smudge-proof, blot-proof permanent presentation of the charted data.

Other Mainframe Features Explained

All plug-in module outputs are available from the rear of the mainframe. The output voltage (0 to ± 5 V) can be used as signal input to other monitoring/recording instruments. The rear panel also implements remote selection of chart speeds, including Stop, using a contact closure or TTL level change.

Both the 7402A and 7404A are designed and tested to operate in extremely adverse environments. This includes vibration (5-55 Hz, 0.01 in. peak-to-peak); operating temperatures (0-55°C); and humidity (95% at 40°C).

Both units also are designed with a single high resonant pen frequency, approximately 800 Hz, that is well above the range of the recorder. This capability ensures proper pen response at higher operating frequencies without unwanted perturbations.

User Plug-in Modules Available

Either recorder can be reconfigured by the user with a simple change of plug-in signal conditioner module. The range of modules to change both voltage and transducer compatibility are:

17400A high gain preamplifier—Max sensitivity of 1 μ V/div (50 μ V span) and 21 calibrated ranges. Input is differential, floated, and guarded. Module provides calibrated zero suppression.

17401A medium gain preamplifier—Max sensitivity of 1 mV/div (50 mV span) and 12 calibrated ranges. Input is differential and balanced to ground. Calibrated zero suppression is optional.

17402A low gain preamplifier: Max sensitivity of 20 mV/div (1V span) and 8 calibrated ranges. Inputs are single ended from both the front and rear connectors.

17403A AC carrier preamplifier: Max input sensitivity of 0.1 mV/V/full scale. Accepts inductive and resistive transducers, such as strain gauges, LVDTs, etc. Module supplies an excitation voltage of 5 V at 2.4 kHz, 15 calibrated range steps, and calibrated zero suppression. When module is used, a 2.4 kHz carrier frequency oscillator (Option 011) must be ordered with the mainframe.

7402A, 7404A Specifications

Analog channels:

7402A: 2 channels

7404A: 4 channels

Chart description: 84 m (275 ft) long with 50 div, full scale

7402A: 50 mm wide channels

7404A: 40 mm wide channels

Chart speed: Controlled by front panel, rear panel TTL or contact closure

7402A: 1, 5, 25, 125 mm/s

7404A: 5, 10, 25, 50, 100, 200 mm/s and mm/min

Chart speed accuracy (25°C): $\pm 0.5\%$ plus power line frequency variation

Chart weave: ± 0.25 mm maximum

Zero adjustment: ± 30 div from grid center

Writing system: Black ink with rectilinear presentation; 55 cc throwaway ink cartridge

Operating environment: 0-55°C and up to 95% humidity maximum from 25-40°C for mm/s speeds and up to 80% humidity for mm/min speeds

Power: 100, 120, 220, 240 Vac

7402A: +5%, -10%, 60 Hz, 140 VA

7404A: $\pm 10\%$, 60 Hz, 300 VA

Weight:

7402A: 18.2 kg (40 lb.); shipping: 26.9 kg (59 lb)

7404A: 31.4 kg (69 lb.); shipping: 43.2 kg (95 lb)

Size:

7402A: 284 H x 253 W x 384 mm D (11 $\frac{1}{4}$ x 9 $\frac{7}{8}$ x 15 $\frac{1}{8}$ in.)

7404A: 290 H x 438 W x 384 mm D (11 $\frac{3}{8}$ x 17 $\frac{1}{4}$ x 15 $\frac{1}{8}$ in.)

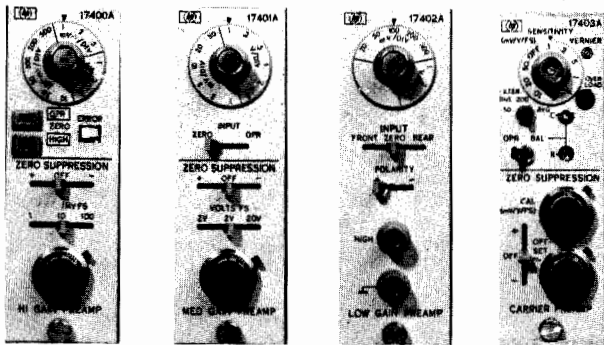

Preamps for 7402A and 7404A

17400A Series Specifications

17400A High Gain

Input ranges: 1, 2, 5, 10, 20, 50, 100, 200, 500 $\mu\text{V}/\text{div}$ and mV/div ; 1, 2, 5 V/div continuous vernier between ranges

Input type: Differential, floated and guarded through rear connector
Common mode rejection: 150 dB DC and 140 dB at line frequency with 1 k ohm source imbalance; 90 dB DC and 80 dB at 60 Hz on 10 $\mu\text{V}/\text{div}$ and above

Frequency response: 10 divisions deflection: 3 dB at 110 Hz on 10 $\mu\text{V}/\text{div}$ range and above

Typical rise time: 7.5 ms (10 to 90% of full scale deflection)

Overshoot: Less than 2% of full scale

Accuracy: $\pm 1\%$ of full scale; includes linearity (calibrated range, 25°C, temp coefficient 0.06%/°C)

Range accuracy: $\pm 1\%$ of full scale; $\pm 0.2\%$ of reading (25°C, temp coefficient 0.06%/°C). Linearity is included

Zero suppression: 1, 10, 100 V on 10 mV/div range and above; other ranges 1, 10, 100 mV. Continuous calibrated 10-turn vernier between suppression steps

Zero suppression accuracy: $\pm 0.5\%$ of setting or of full scale, whichever is greater

17401A Medium Gain

Input ranges: 1, 2, 5, 10, 20, 50, 100, 200, 500 mV/div ; 1, 2, 5 V/div. Continuous 10-turn vernier between ranges

Input type: Balanced to ground. Inputs through rear connector

Input resistance: 1 M ohm

Common mode rejection: Greater than 50 dB to line frequency. 100 ohm source imbalance

Frequency response (10 divisions deflection):

7402A: 3 dB at 140 Hz

7404A: 3 dB at 150 Hz

Typical rise time: 7.5 ms (10 to 90% of full scale deflection)

Overshoot: Less than 2% of full scale

Accuracy: $\pm 1\%$ of full scale; includes linearity (calibrated range, 25°C, temp coefficient 0.06%/°C)

Range accuracy: $\pm 1\%$ of full scale; $\pm 0.2\%$ of reading (25°C, temp coefficient 0.06%/°C). Linearity is included

Zero suppression:

Optional: 0.2, 2, 20 V. Continuous calibrated 10-turn vernier between ranges

Zero suppression accuracy: $\pm 0.5\%$ of setting or of full scale, whichever is greater.

17402A Low Gain

Input ranges: 20, 50, 100, 200, 500 mV/div ; 1, 2, 5 V/div. Continuous 10-turn vernier between ranges

Input type: Single ended. Inputs through front or rear connector.

Input resistance: 1 M ohm minimum

Frequency response (10 divisions deflection):

7402A: 3 dB at 140 Hz

7404A: 3 dB at 150 Hz

Typical rise time: 7 ms (10 to 90% of full scale deflection)

Overshoot: Less than 2% of full scale

Accuracy: $\pm 1\%$ of full scale (calibrated range, 25°C, temp coefficient 0.06%/°C). Linearity is included

Range accuracy: $\pm 0.2\%$ of reading. Linearity is included (25°C, temp coefficient 0.06%/°C)

17403A Carrier

Input ranges: 0.1, 0.2, 0.5, 1, 2, 5, 10, 20, 50 $\text{mV}/\text{V}/\text{full scale}$. Continuous vernier between ranges. Sensitivities shown above also divisible by 100

Input type: Differential, floating

Common mode rejection: 120 dB DC to line frequency with 1 k ohm source imbalance

Frequency response (10 division deflection):

7402A: 3 dB at 140 Hz

7404A: 3 dB at 150 Hz

Typical rise time (10 to 90% of full scale deflection): 7.5 ms with preamp filter switch to 50 or 200; 1 s with switch to AVG

Overshoot: Less than 2% of full scale

Accuracy: $\pm 0.6\%$ of full scale (calibrated range, 25°C, temp coefficient 0.06%/°C)

Range accuracy: $\pm 0.2\%$ of reading (25°C, temp coefficient 0.06%/°C). Linearity is included

Zero suppression: 10-turn controls from 1 to 100% of full scale

Zero suppression accuracy: $\pm 0.5\%$ of setting or of full scale, whichever is greater

Drift (zero line referenced to input): $\pm 0.2 \mu\text{V}/\text{V}/\text{week}$, including excitation drift

Balance control (R balance): $\pm 5 \text{ mV}/\text{V}$. Temp coefficient $\pm 1.8 \mu\text{V}/\text{V}/\text{°C}$

Quadrature rejection: 40 dB at 2.4 Hz. Quadrature tolerance: 2.1

Transducer excitation:

Full bridge: 5.0 V rms $\pm 5\%$, 2.4 kHz $\pm 3\%$

Half bridge: One-half full bridge

Excitation load resistance: 100 ohms minimum; unlimited short circuit duration

7402A Options

Option	Description	Price
001	Event marker, left hand	\$150
003	Event marker, left hand & event marker/timer, right hand for 1 s intervals	\$275
004	50 Hz power line operation	N/C
005	Paper take up, external	\$200
008	Event marker/timer, right hand, for minutes & seconds. Not compatible with Options 001 or 003	\$215
009	60:1 speed reducer	\$275
010	Hard cover. Not compatible with Options 005 or 908	\$75
011	2.4 kHz oscillator for 17403A	\$80
016	White paint	\$125
908	Rack mounting adapter	\$160

7404A Options

Option	Description	Price
004	50 Hz power line operation	N/C
005	Paper take up, external	\$370
010	Hard cover. Not compatible with Options 005, 012 or 908	\$75
011	2.4 kHz oscillator for use with 17403A	\$80
012	Rack mount adapter for 1064A	\$145
013	Channel 2 event marker	\$70
014	Channel 3 event marker	\$70
015	Channel 4 event marker	\$70
016	White paint	\$125
908	Rack mount adapter	\$200

Ordering Information

Item	Price
Specify Option 016 for no charge white paint on preamps	
7402A Mainframe (less preamps)	\$3950
7404A Mainframe (less preamps)	\$7000
17400A High-gain preamplifier	\$1250
17401A Medium-gain preamplifier	\$450
Option 001: (zero suppression) for 17401A	add \$200
17402A Low-gain preamplifier	\$300
17403A AC carrier preamplifier	\$1100

RECORDERS & PRINTERS

Four and Eight-Channel Oscillographic Recorders

Models 7414A, 7418A & 8800 series signal conditioners

- Thermal writing for low maintenance
- Z-fold paper for easy review/storage
- Available in benchtop configuration, mobile cart, upright cabinet

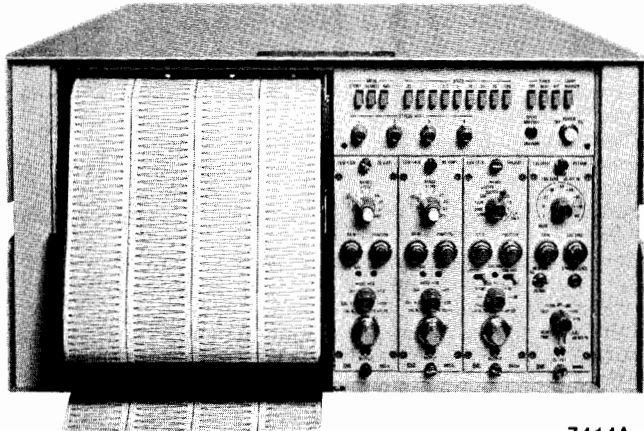

7414A

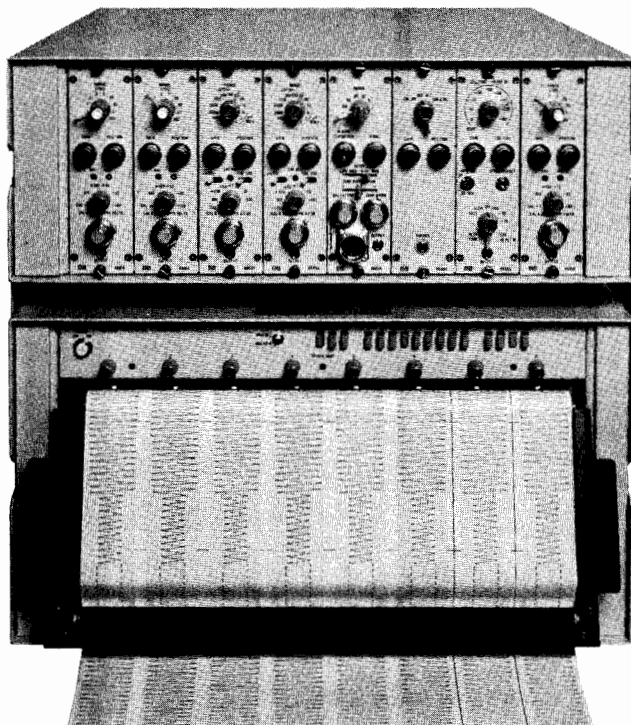

7418A with Options 030 and 003

Models 7414A 4-Channel and 7418A 8-Channel Oscillographic Recorders provide permanent reproducible records of multichannel, real-time data. A complement of 8800 Series Plug-in Signal Conditioners results in a system capable of meeting many measurement requirements in a reliable, versatile manner.

Thermal writing tips feature long stylus life and rectilinear presentations. A Z-fold chart paper pack loads easily, allows for convenient data review and storage. Two markers are supplied. The timer marker can be selected for one-second or one-minute marks. The event marker can be activated remotely or by front panel pushbutton.

7414A, 7418A, 8800 Series Plug-in Specifications

7414A General Specifications

Chart speeds: 0.25, 0.5, 1.0, 2.5, 10, 25, 50, 100 mm/s. Speed regulation $\pm 1\%$. Paper weave less than 0.5 mm. Speed selected via front panel pushbuttons. Optional speeds in mm/min.

Limiting: electrical limiting keeps stylus within channel.

Markers: Event (local or remote control) between ch 3 and 4. (Timer (1 min or 1 s selectable) between ch 1 and 2.

Chart paper: four 40 mm wide channels each with 50 div; time lines every 1 mm; heat sensitive Z-fold Permapaper® with green grid lines available in packs of 500 sheets, each 30 cm (12"). (Part number 9270-0878).

Paper loading: no threading required.

Remote operation: rear panel connector provides for remote chart drive and event marker activation.

Power: 115/230 V ac $\pm 10\%$, 60 Hz, 350 VA (includes plug-ins) 50 Hz optional.

Size: 266.7 H \times 482.6 W \times 577.9 mm D (10½" \times 19" \times 22¾"). Projection: 76.2 mm (3") from rack front.

Weight: net, 50.5 kg (112 lb). Shipping, 59.5 kg (132 lb).

7418A General Specifications

Chart speeds: 0.5, 1, 2.5, 5, 10, 25, 50, 100, 200 mm/s. Speed regulation $\pm 1\%$. Paper weave less than 0.5 mm. Speed selected via front panel pushbuttons (or remote). Optional speeds in mm/min.

Chart Paper: Eight 40 mm wide channels each with 50 divisions; time lines every 1 mm. Heat sensitive Chemical Thermal Paper standard for all system recorders except option 050. Permapaper® for Option 050 recorders only. Chemical Thermal Paper available in packs of 400 sheets, each 30.1 cm (12") long \times 40.2 cm (15.8") wide (part number 9270-0563 red grid). Permapaper available in packs of 500 sheets, each 30.1 cm (12") long \times 40.2 cm (15.8") wide (part number 9270-0946 green grid).

Remote operation: rear panel connector provides for chart drive and event marker, optional extra markers. Remote connector supplies -20 V.

Power: 115/230 V ac $\pm 10\%$, 60 Hz. Recorder only 575 VA; system plug-ins 695 VA.

Size: rack: 266.7 H \times 482.6 W \times 577.9 mm D (10½" \times 19" \times 22¾"). Projection: 76.2 mm (3") from front of rack.

Weight: 50 kg (110 lb) including driver amplifiers.

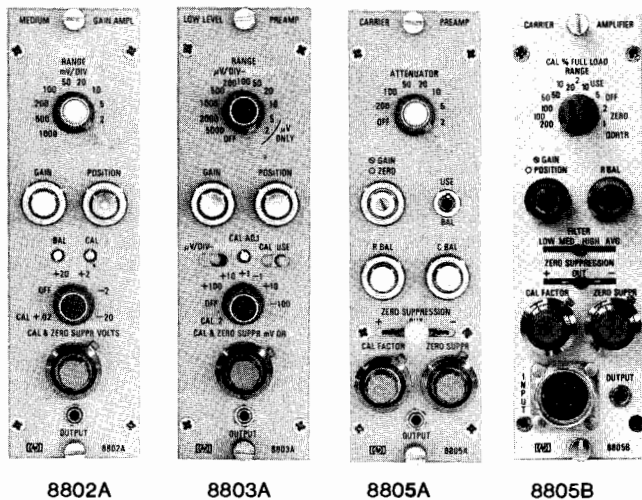

8802A

8803A

8805A

8805B

8801A Low Gain DC Amp

Input ranges: 5, 10, 20, 50, 100, 200, 500, 1000, 2000, 5000 mV/div; accuracy $\pm 1\%$.

Max sensitivity: 5mV/div (gain 20).

Max fs input: 250V.

Input circuit & input frequency range: resist. 500 k Ω $\pm 1\%$ each side bal to gnd; parallel with approx. 100 pF

Rise time (10 div, 10-90%, 4% overshoot): 5 ms.

Calibration (referred to input): 100 mV, $\pm 1\%$, internal.

Output frequency response (-0.5 dB at 50 div): 50 Hz.

Zero suppression: ± 10 and ± 100 V for single-ended or diff. signals. 10-T pot sets precise values of zero suppression voltages; ± 50 V max suppress on 5, 10, 20 mV/div ranges; max error of suppression $\pm 0.5\%$ of suppression range, and 1% of indicated suppression.

Output noise, max (less trace width): 0.2 div, p-p.

Zero drift, 20° to 40°C, 103 to 127 V (less trace width): temp—1.25 div/10°C, 0.5 div/hr, constant ambient. Line voltage—0.15 div.

Common mode rejection and tolerance: 48 dB min, dc to 150 Hz; ± 50 V max on other ranges for $< 1\%$ change in differential sensitivity.

Output linearity (less trace width): 0.25 div, after calibration for zero error to center scale +20 div.

8802A Medium Gain DC Amp

Input ranges: 1, 2, 5, 10, 20, 50, 100, 200, 500, 1000 mV/div; accuracy $\pm 1\%$.

Max sensitivity: 1 mV/div (gain 100).

Max fs input: 50 V.

Input circuit and input frequency range: resist 180 k Ω $\pm 1\%$, each side bal to gnd, parallel with approx 100 pF.

Rise time (10 div, 10-90%, 4% overshoot): 5 ms.

Calibration (referred to input): 20 mV, $\pm 1\%$, internal.

Output frequency response (-0.5 dB at 50 div): 50 Hz.

Zero suppression: ± 2 V and 20 V for single-ended or differential signals; 10-T pot sets precise values of zero suppression voltages; ± 12.5 max suppression on 1, 2, 5 mV/div ranges; max error of suppression $\pm 0.5\%$ of suppression range and 1% of indicated suppression.

Output noise, max (less trace width): 0.2 div, p-p.

Zero drift, 20° to 40°C, 103 to 127 V (less trace width): same as 8801A.

Common mode rejection and tolerance: 48 dB min dc to 60 Hz, 1000 mV/div range; 48 dB min. dc to 150 Hz other ranges ± 12.5 V on 1, 2, 5 mV/div ranges; ± 125 V on 10, 20, 50 mV/div ranges; ± 500 V max other ranges for less than 1% change in differential sensitivity.

Output linearity (less trace width): same as 8801A.

8803A High Gain DC Amp

Input ranges: 1, 2, 5, 10, 20, 50, 100, 200, 500, 1000, 2000, 5000 μ V/div; 10, 20, 100, 200, 500, 1000, 2000, 5000 mV/div; accuracy $\pm 1\%$ on 5000 μ V/div to 20 μ V/div ranges, $\pm 2\%$ on 10 μ V/div to 1 μ V/div; accuracy of x 1000 attenuator $\pm 1\%$.

Max sensitivity: 1 μ V/div (gain 100,000)

Max fs input: 250 V.

Input circuit and input frequency range: 1 M Ω min on μ V range, independent of gain; 5 M Ω on mV range; floating and guarded.

Rise time (10 div, 10-90%, 4% overshoot): 5 ms. 6% overshoot.

Calibration (referred to input): 200 μ V $\pm 1\%$ internal on μ V/div range; 200 mV $\pm 1\%$ internal on mV/div range.

Output frequency response (-0.5 dB at 50 div): 50 Hz.

Zero suppression: μ V ranges ± 1 , ± 10 , ± 100 mV; mV ranges ± 1 , ± 10 , ± 100 V, 10-T pot sets precise values of zero suppression voltages; accuracy $\pm 1\%$ suppression range.

Output noise, max (less trace width): 1.5 mm p-p at 1 μ V/div; 0.1 div, p-p min gain.

Zero drift, 20% to 40%, 103 to 127 V (less trace width): temp— μ V range 1 Ω V/10° referred to input, ± 0.26 div/10° C for 0 output & ± 0.65 div/10° C for fs output. mV range, 1 mV/10° C referred to input, ± 0.26 div/10° C for 0 output. Line voltage 0-0.07 div; fs 0.35 div.

Common mode rejection and tolerance: μ V range, max source unbal of 1 k Ω ; 160 dB min at dc, 120 dB min at 60 Hz; mV range, max source unbal of 500 k Ω ; 100 dB min at dc, 60 dB min at 60 Hz dc. 300 V pk; 60 Hz. 1 μ V/div, 10 V rms; 2 μ V/div, 20 V rms; 5 μ V/div, 50 V rms; 10 μ V/div and 10 mV/div, 100 V rms; 20 μ V to 5000 μ V/div and 20 mV to 5000 mV/div, 200 V rms.

Output linearity (less trace width): 1 mV range 0.35 div, others 0.25 div after calibrating for zero error at center scale and +20 div.

8805A/B Carrier Preamp

Input ranges: X1, 2, 5, 10, 20, 50, 100, 200; accuracy $\pm 2\%$.

Max sensitivity: 10 μ V rms/div (gain 10,000 rms ac to dc)

Max fs input: 100 mV rms.

Input circuit and input frequency range: input impedance—8805A approx 10 k Ω ; 8805B 1 M Ω $\pm 10\%$; single-ended. Min load resistance across excitation 100 Ω . Max impedance in series with input (transducer output impedance) 5 k Ω . Excitation—floating source 5 V rms nominal at 2400 Hz $\pm 2\%$. Internal switch allows use with full or half bridge transducer.

Rise time (10 div, 10-90%, 4% overshoot): 5.6 ms.

Calibration (referred to input): 2% $\pm 0.02\%$ of transducer fs output. Adjust by Cal Factor control; accuracy ± 55 μ V/V out of 10mV/V. 8805B switchable Cal voltage to 2%, 10%, 50%, or 100% $\pm 1\%$ of fs.

Output frequency response (-0.5 dB at 50 div): 50 Hz.

Zero suppression: 0-100% of transducer full load rating, for transducers having Cal Factor up to 10 mV/V at full load, 10-T pot with calibration dial; accuracy—1 dial div $\pm 0.5\%$ of suppress range. Zero Supp Polarity switch, Separate R Bal control allows bucking of in-phase unbal to ± 3 mV/V regardless of Cal Factor.

Output noise, max (less trace width): approx. 0.2 div, p-p.

Zero drift, 20% to 40%, 103 to 127 V (less trace width): temp—0.45 div/10° C; Line voltage—0.25 div.

Common mode rejection and tolerance: quadrature rejection and tolerance: > 40 dB. Tolerance error: $< \pm 2\%$ fs when quadrature voltage equal to twice in-phase signal required for center to edge deflection on chart. C Balance control permits bucking of transducer's quad unbalance of up to ± 5 mV/V. The 8805B has automatic C balance.

Output linearity (less trace width): 0.4 div after calibrating for zero error at center scale and +20 div.

RECORDERS & PRINTERS

Four and Eight-Channel Oscillographic Recorders

Models 7414A, 7418A & 8800 series signal conditioners (cont.)

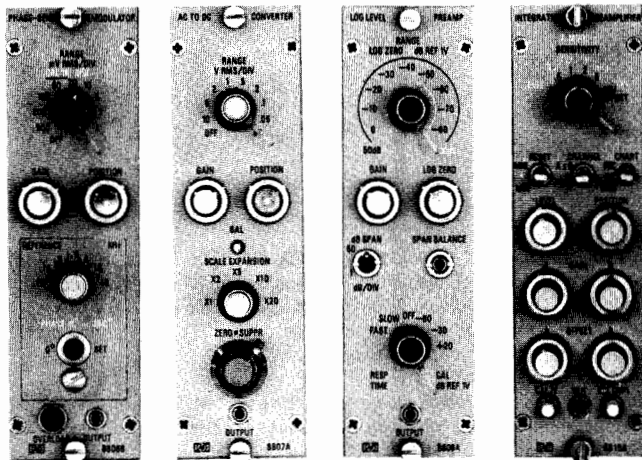

8806B

8807A

8808A

8815A Opt. 002

8806B Phase Sensitive Demodulator

Input ranges: sig input—0.5, 1, 2.5, 10, 20, 50, 100, 200, 500 mV/div; $\pm 1\%$, 50 Hz to 10 kHz; $\pm 2\%$, 10 kHz; $\pm 3\%$, 20 kHz to 40 kHz. Reference voltage—3 to 20 rms, 20 to 133 V rms.

Max sensitivity: 0.5 mV rms/div (gain 200 rms ac to dc).

Max fs input: 25 V rms full scale.

Input circuit and input frequency range: signal input:—transformer isolated, floating point and guarded; resistance approx 1 M Ω . Reference input: differential, transformer coupled; resistance approx 500 k Ω each side to ground, may be used single ended. 50 Hz to 40 kHz in 6 bands with variable frequency plug-in; 60 Hz, 400 Hz and 5 kHz fixed frequency phase shifter plug-in; special order phase shifter plug-ins 50 Hz to 40 kHz. Note: must order with frequency plug-in.

Rise time (10 div, 10-90%, 4% overshoot): 5 ms (5 kHz ref).

Calibration (referred to input): 1 V rms internal at carrier reference frequency; $\pm 1\%$ 50 Hz to 10 kHz; $\pm 2\%$ 10 kHz to 20 kHz; $\pm 3\%$ 20 kHz to 40 kHz.

Zero suppression: none. Phase shifter plug-ins allow control of reference phase over 360°. Fixed frequency: 0° to 90° dial; 2° graduations; any of 4 quadrants by panel switches; dial accuracy within $\pm 3^\circ$. Variable frequency: adjust thru 360°.

Output noise, max (less trace width): 7 μ V x sq root of frequency response, referred to input.

Zero drift, 20° to 40°C, 103 to 127 V (less trace width): temp: 0.5 div/10°C; Line voltage: 0.25 div.

Common mode rejection and tolerance: CM: >40 dB up to 10 kHz 500 V rms, max. Quadrature tolerance: equal to amplitude of a fs, in-phase signal.

Output linearity (less trace width): 0.4 div after calibrating for zero error at center scale and +20 div.

8807A AC to DC Converter

Input ranges: 0.02, 0.05, 0.1, 0.2, 0.5, 1, 2, 5, 10 V rms/div, $\pm 2\%$ (midband). Scale expansion: X1, 2, 5, 10, 20, $\pm 2\%$.

Max sensitivity: 1 mV rms/div (gain 100 rms ac to dc). 20 mV rms/div with X1 scale expansion.

Max fs input: 500 V rms.

Input circuit and input frequency range: approx 1 M Ω resistive in parallel with 10 pF and stray cable capacitance; floating and guarded. Standard model: 330 Hz to 100 kHz; Opt 001: 50 Hz to 100 kHz.

Rise time (10 div, 10-90%, 4% overshoot): 11.2 ms. Opt 001: 70 ms, approx 10% overshoot.

Calibration (referred to input): 1 V internal $\pm 1\%$; approx 500 Hz. **Output frequency response (-0.5 dB at 50 div):** 54 Hz (3 dB at 10 div). Opt 001—9Hz.

Zero suppression: up to 100% of fs on any range can be suppressed; 10-T pot with calibrating dial. Scale expansion: 5, 10, 20, or 50% of fs can be expanded to cover full chart.

Output noise, max (less trace width): baseline offset/noise: 2 mV rms referred to input +0.025 div X scale expansion

Zero drift, 20° to 40°C, 103 to 127 V (less trace width): temp 0.03 div/10°C X scale expansion +0.35 div/10°C; at constant ambient 0.005 div/hr X scale expansion. Line voltage 0.005 div X scale expansion +0.1 div.

Common mode rejection and tolerance: 60 dB min at 60 Hz; 40 dB min at 400 Hz with up to 10 K source unbalance; ± 500 V pk.

Output linearity (less trace width): 0.55 div +0.05 div X scale expansion, 330 Hz to 5 kHz; Opt 001: 60 Hz to 5kHz, after calibration for zero error at lower and upper ends of printed coordinates.

8808A Log Level Preamp

Input ranges: 50 dB span: bottom scale -80, -70, -60, -50, -40, -20, -10, and 0 dB below 1 V (i.e. 100 μ V, 320 μ V, 1, 3.2, 10, 32, 100, 320 mV and 1V). 100 dB span bottom scale -80, -70, -60, and -50 dB below 1 V.

Max sensitivity: 100 μ V rms sine wave corresponds to bottom scale output, -80 dB below 1 V.

Max fs input: 320 V rms.

Input circuit and input frequency range: single ended, resistance 1 M Ω min. 5 Hz to 100 kHz for <3dB down from the midband level on "Slow" response range; 500 Hz to 100 kHz on "Fast" response range.

Rise time (10 div, 10-90%, 4% overshoot): fast: 20.5 rms (87.5 dB/s) Slow: 2 s (9 dB/s).

Calibration (referred to input): internal from oscillator at approx 500 Hz. -80, -30, and ± 20 dBV = dB ref. to 1 V (100 μ V, 32mV and 10 V) -80 +20 dBV internally adjustable: -30 dBV accuracy ± 0.25 dB (at 115 V line at 25°C).

Output noise, max (less trace width): 50 dB range: 0.8 div, p-p, 100 dB range: 0.4 div, p-p (max noise at bottom of recording chart).

Output linearity (less trace width): departure from log characteristics 50 dB: 1.25 div, 100 dB: 1 div, after calibrating for zero error at lower and upper ends of printed coordinates.

8809A Signal Coupler

Input ranges: continuously adjustable from 20 to 50 mV/div.

Max sensitivity: 30 mV/div (gain 3.33).

Max fs input: 0 to +2.5 V or 0 to -2.5 V.

Input circuit and input frequency range: switch selected: 1500 Ω $\pm 2\%$ or 100 k Ω min, incremental; single ended.

Rise time (10 div, 10-90%, 4% overshoot): 5 ms.

Calibration (referred to input): 600 mV $\pm 2\%$, internal.

Output frequency response (-0.5 dB at 50 div): 50 Hz.

Output noise, max (Less trace width): 0.1 div, p-p.

Zero drift, 20° to 40°C, 103 to 127 V (less trace width): temp: 0.4 div/10°C at 30 mV sensitivity. Line voltage: 0.3 div.

Common mode rejection and tolerance: 50,000: 1 at dc.

Output linearity (less trace width): 0.4 div after calibrating for zero error at center scale and +20 div.

8815A Opt 002 General Purpose Integrator

Sensitivity ranges: 0.2, 0.5, 1, 2, 5. Sensitivity setting of 1 results in the following integrator outputs:

Seconds integrator: 1 volt per volt-second input (0.1 volt-seconds per recorded division, or 5 volt-seconds full scale).

Minute integrator: 1 volt per 60 volt-seconds input (6 volt-seconds per recorded division or 300 volt-seconds full scale). For other sensitivity settings, divide the above volt-second values by the sensitivity switch setting.

Offset control: ± 2.8 volts referred to input. Can be used with switch-selectable rectifier to rectify (or ignore) portions of roughly sinusoidal inputs.

Drift: seconds integrator, ± 5 mV/s, referred to output; minute integrator, ± 15 mV/min., referred to output.

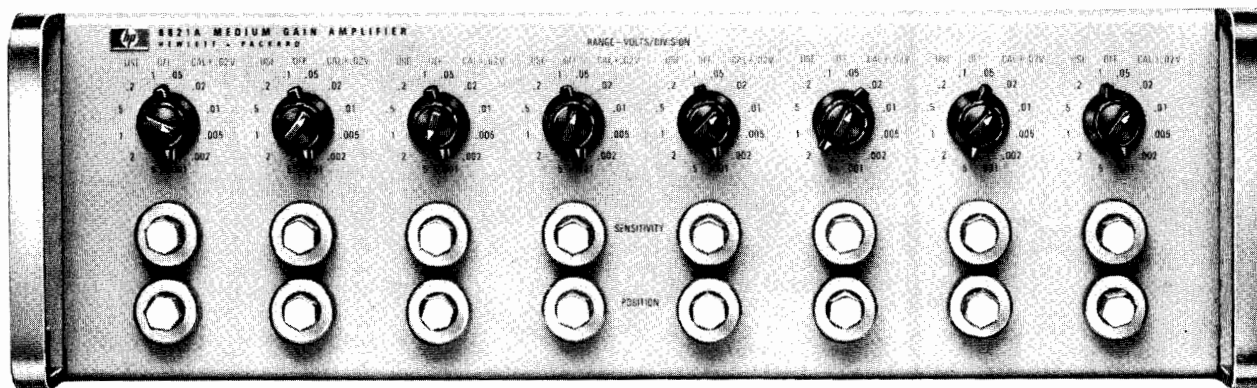

8821A

8820A Eight Channel Bank Amplifier

Max sensitivity: 0.05 V/div (Amplifier Gain 2).
Max fs input: 250 V (edge to edge).
Input ranges (attenuation): 0.05, 0.1, 0.2, 0.5, 1, 2, 5 V/div. Attenuator accuracy $\pm 2\%$.
Input circuit: single ended, 1 M Ω min.
Frequency response: dc to < 0.5 dB down at 50 Hz (50 div. p-p; dc to < 3 dB down at 100 Hz (10 div. p-p)).
Rise time (10 div, 10-90%, 4% overshoot): < 6 ms.
Output linearity (less trace width): linear within ± 0.25 div. after setting mechanical zero of stylus to within ± 1 div of chart center and calibrating for zero error at center scale and ± 20 div.
Drift, 20° -40°, 115 V $\pm 10\%$, 60 Hz (less trace width): temp: $< 0.55\%/10^\circ\text{C}$; Line voltage: $< \pm 0.2$ div.
Calibration: 1 V $\pm \%$ calibration voltage for all channels.
Temp rating: operating: 0°C to +55°C; storage: -40°C to 75°C.

8821A Eight Channel Bank Amplifier

Max sensitivity: 0.001 V/div (Amplifier Gain 100).
Max fs input: 250 V (edge to edge).
Input ranges (attenuation): 0.001, 0.002, 0.005, 0.010, 0.020, 0.050, 0.1, 0.2, 0.5, 1, 2, 5 V/div. Attenuator accuracy (dc) $\frac{1}{2}\%$ on 0.001 to 0.050 V/div ranges; 1% on 0.1 to 5 v/div ranges.
Input circuit: balanced, floating and guarded, 9 M Ω constant for all gain settings (0.001 to 0.050 V/div); 4.5 m Ω each side to ground (0.1 to 5 V/div).
Common mode rejection: 100 dB at 60 Hz, 0.001 V/div sensitivity, 1 k Ω source unbalance decreases to 66 dB at 0.05 V/div, 66 dB at 60 Hz, 0.01 to 5 V/div sensitivity. 1 k Ω source unbalance.
Common mode tolerance: ± 20 V on 0.001 to 0.05 V/div ranges (6 most sensitive); ± 250 V on 0.1 to 5 V/div ranges (6 least sensitive).
Frequency response: dc to < 0.5 dB down at 50 Hz (50 div, p-p). dc to < 3 dB down at 200 Hz (10 div p-p).
Rise time (10 div, 10-90%, 4% overshoot): < 6 ms.
Output linearity (less trace width): same as 8820A.
Drift, 20° to 40°C, 115 V $\pm 10\%$, 60 Hz (less trace width): same as 8820A.
Calibration: +0.02 V $\pm 1\%$ on 6 most sensitive ranges. Simulates +2 V $\pm 2\%$ at input on 6 least sensitive ranges.
Temperature rating: same as 8820A.

Ordering Information

	Price
7414A 4-channel Oscillographic Recorder	\$8030
Opt 001: rack mount kit with slides and mounting hardware; delete case.	N/C
Opt 008: 50Hz operation	N/C
Opt 015: extra Event Marker, between channels 2 & 3	add \$110
Opt 025: 60:1 speed reduction (50Hz), requires Opt 008	add \$450
Opt 026: 60:1 speed reduction (60Hz)	add \$450
Opt 054: installed in mobile cart. Rack space: 53 cm (21"). Cart height: 102 cm (40.75"). Includes paper takeup drawer.	add \$1450

7418A 6 to 8-channel Oscillographic Recorder

	\$10,500
Opt 001: 6 channel Hot-tip Thermal Recorder only; includes takeup tray. Plug-in preamplifiers require Opt 030 Power Supply; for 8-channel Bank Amplifiers (Power Supply included) select Opt 031 or 032	less \$620
Opt 002: rack mount kit	add \$350
Opt 003: bench-top configuration	add \$530
Opt 004: 160 cm (63") rack space cabinet. Cabinet height: 177 cm (72.5"). Includes paper takeup drawer.	add \$2600
Opt 006: Portable Cart with 71cm (28") rack space, includes Opt. 002. Cart height: 126 cm (50.5").	add \$1650
Opt 008: 50Hz operation	N/C
Opt 009: 230 V ac operation	N/C
Opt 014: extra Event Marker between channels 4 & 5	add \$100
Opt 015: extra Event Marker between channels 5 & 6	add \$100
Opt 025: 60:1 speed reduction (50Hz), requires Opt 008	add \$430
Opt 026: 60:1 speed reduction (60Hz)	add \$430
Opt 030: 8848A plug-in Preamplifier Power Supply, required for operation of 8800 preamplifiers	add \$2450
Opt 031: 8820A 8-channel Low Gain Bank Preamplifier	add \$4200
Opt 032: 8821A 8-channel Medium Gain Bank Preamplifier	add \$5250
Opt 035: rack mount kit for HP29400 series cabinet	add \$310
Opt 050: recorder equipped for permapaper operation only	N/C
8801A Low Gain Preamplifier	\$650
8802A Medium Gain Preamplifier	\$700
8803A High Gain Preamplifier	\$1650
8805A Carrier Preamplifier	\$1275
Opt 002: Harmonic Filter Kit, required when 267, 268, 270, or 1280B, C transducers are used	add \$50
8805B Opt 012 Carrier Preamplifier without Harmonic Filter	\$1225
8806B Phase Sensitive Demodulator Preamplifier. Requires one of following plug-ins:	\$1325
Opt 002: Variable Frequency Phase Shifter plug-in, 50Hz to 40kHz	add \$500
Opt 003: 60Hz Phase Shifter plug-in	add \$375
Opt 004: 400Hz Phase Shifter plug-in	add \$350
Opt 005: 5kHz Phase Shifter plug-in	add \$300
8807A AC/DC Converter Preamplifier	\$1900
Opt 001: 50Hz to 100kHz Signal Filter	N/C
Opt 002: DC Plug-in	N/C
8808A Logarithmic Preamplifier	\$1475
8809A Signal Coupler Preamplifier	\$410
8815A Opt 002 General Purpose Integrator	\$1500
Opt 003: Sample and hold (for digital display readouts)	\$225
8820A Low Gain Bank Preamplifier (8-channel)	\$4200
8821A Medium Gain Bank Preamplifier (8-channel)	\$5250

RECORDERS & PRINTERS

Instrumentation Tape Recorders

A Review

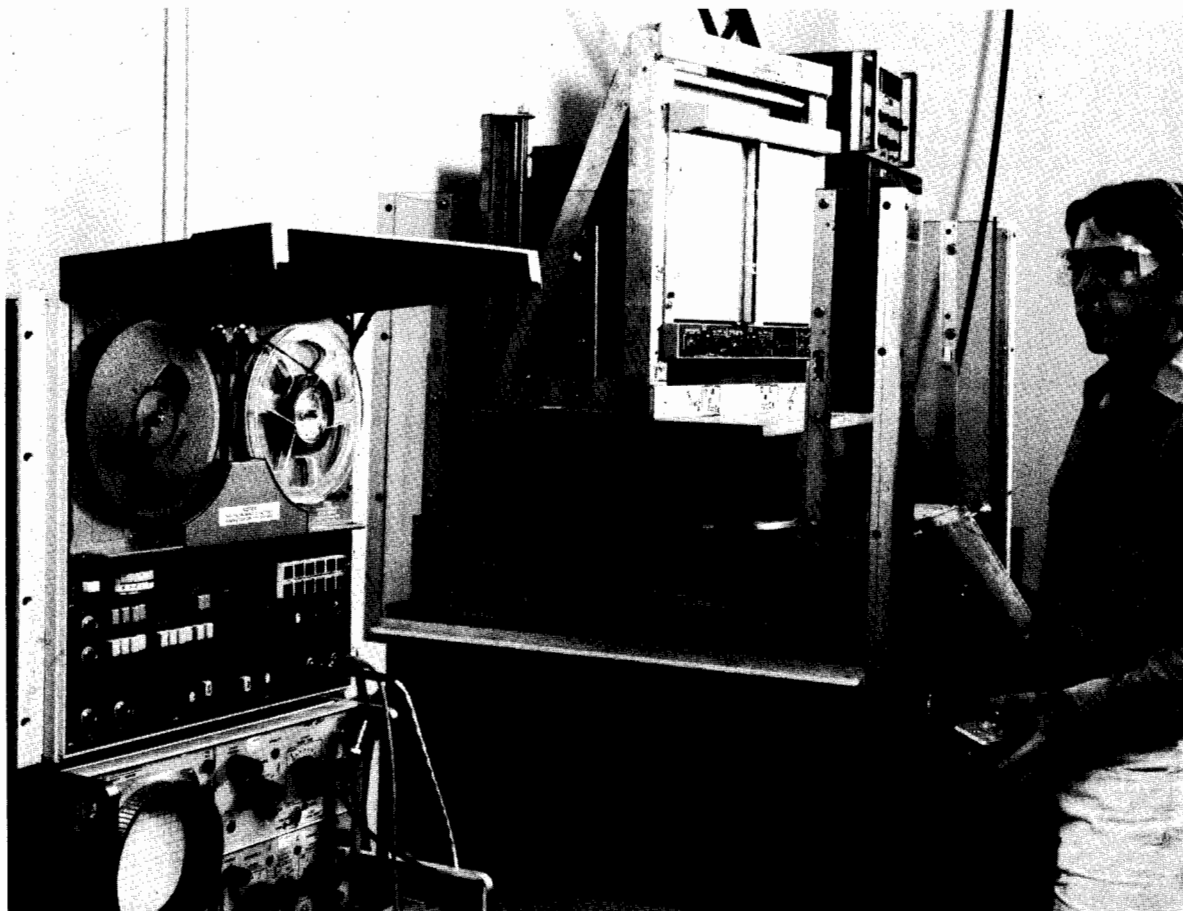

Introduction

Instrumentation tape recorders (ITR's) are used to record, store, and reproduce test data for many and varied applications. The main reasons for using ITRs are economy, accurate data recording and reproduction, and long-term data storage. ITRs manufactured by Hewlett-Packard are 4 or 8-channel recorders using 1/4-inch tape. They are designed specifically for applications under 64 kHz. ITR recording provides nondestructive reproduction so data can be reproduced repeatedly without degrading the quality, and time-base can be contracted or expanded. Data is contracted by using faster tape speeds to reproduce slow-speed data or expanded by doing the reverse to produce, for example, lower frequency data for use on a graphics recorder.

ITR Characteristics Explained

Direct Record/Reproduce Electronics: Direct electronics accept frequencies above 100 Hz (approximate) and record the amplitude of the input signal on the tape as a proportional magnetic flux intensity. Because direct electronics require a "linear" relationship, changing tape type (as from 3M 890 to 3M 990) generally necessitates the re-equalization of each direct channel. Direct electronics also require that each recorded tape be degaussed (erased) fully before being reused.

FM Record/Reproduce Electronics: FM electronics accept very low frequencies, including DC. In FM, the amplitude of the input signal is recorded as a frequency deviation from a "center" frequency; the maximum input amplitude being recorded as a 40% deviation. Because amplitude is converted to a frequency, FM tends to be insensitive to tape drop-outs, but sensitive to speed irregularities such as flutter. With FM, tape types can be changed without re-equalizing the channel. Since FM records to saturation, tape can be reused without degaussing with only a small (10 to 15 dB) loss in signal-to-noise ratio.

Common Frequency Range: FM and direct have a common segment of the frequency range in which either type of electronics can function. On Hewlett-Packard's ITRs this range is approximately 100 Hz to 5 kHz. The advantages of using direct electronics in this range are high frequency response at slow tape speeds and a general insensitivity to flutter. The advantages of FM are DC response and a general insensitivity to tape drop-outs.

Tape Speed Control: The tape speed is usually controlled by a phase-lock servo system in one of two ways. The more common method uses the servo system to control the

rotational speed of the tape capstan, employing a tachometer mounted on the capstan's shaft to monitor the speed. With this method, tape speed control is limited to approximately $\pm 0.2\%$, because of capstan irregularities, tape slippage, and tape stretching. The less common, but more precise, method uses a frequency reference placed on one track during recording as the speed reference for the phase-lock servo during reproduce. Tape servo generates a reproduce speed that is virtually identical to the record speed; the time difference between events in record and reproduce is indicated by the time base error specification (which assumes continuous phase-lock operation). The time base error figure represents a short-term specification, because drop-outs, etc., may cause momentary loss of phase lock.

Flutter: Short-term tape speed variation. Produces time base perturbations in Direct electronics and noise in FM.

Signal-to-noise ratio: The ratio of maximum to minimum recordable amplitude expressed as a voltage ratio in dB. Basically, it represents the usable dynamic range.

Tape Selection: It is recommended that instrumentation tape such as 3M 890 always be used. Use of other quality of tape may adversely affect head wear, signal-to-noise ratio, etc.

RECORDERS & PRINTERS

Instrumentation Tape Recorders and Degausser

Models 3964A, 3968A, and 13064A Degausser



- Continuing savings by recording on 1/4-inch tape
- Choice of 4 or 8-channel recorders
- Selection of FM or Direct electronics

- Six tape speeds, including 15/32 ips
- Remote control (TTL or optional HP-IB)
- Switch selection of tach or tape servo



3968A



3964A

Models 3964A and 3968A ITR's, 13064A Degausser

The 4-channel 3964A and 8-channel 3968A are quality instrumentation tape recorders (ITRs) that provide cost-saving operation by using 1/4-inch tape for a wide variety of recordings. Medical versions of the 3964A and 3968A (Options 009 and 010) are available. These versions include a UL 544 medical listing; making them useful in hospitals, medical offices, and research facilities.

The 13064A bulk tape degausser erases a complete roll of tape cleanly in seconds. A thoroughly clean tape is necessary to obtain maximum signal-to-noise ratio.

Both the 3964A and the 3968A are precision-built ITRs with features that cut costs; enhance the usefulness of the units; and simplify recording tasks in laboratory, medical, production, and field use.

3964A, 3968A Features

Cost-saving 1/4-inch tape: Provides continuing savings for the life of the recorder. By using 1/4-inch tape, rather than 1/2-inch tape, users can save over 50% on tape costs.

AC/DC calibrator: Provides an internal voltage source that simplifies the set up of input and output levels for each data channel. Six voltages, AC or \pm DC, can be pushbutton selected, applied, and monitored to check out each channel. In addition, there is an external connector to allow the use of scopes or other monitoring devices.

Tach or tape servo control: Tach-servo and tape-servo systems are switch selectable.

Flutter compensation: Improves the signal-to-noise ratio in FM by up to 12 dB in a vibrating environment. When switched on, flutter-generated noise introduced during record and reproduce is subtracted from all FM data channels during reproduce to improve performance. One FM channel is used for flutter compensation; this same channel can also be used for tape servo control, saving a data channel for recording when both flutter compensation and tape servo are required.

Voice capability: Provides voice annotation capability on the 4th channel of the 3964A or the 8th channel of the 3968A, using the press-to-talk microphone. The voice channel accepts data only, voice only, or data with a voice interrupt. Microphone, speaker, and headphone jack are provided with either recorder.

FM electronics-to-electronics (e-e) mode: Transfers the input signal automatically to output, bypassing the record/reproduce heads. This occurs when tape is below record/reproduce speed or in Fast Forward, Rewind, or Stop mode. E-E allows the unit to be set and calibrated without using tape.

Instrumentation Tape Recorder Notes

These technical application notes are available, at no charge, from your Hewlett-Packard sales office:

Topic	Application Note No.	Part Number
Dropouts	213-1	5952-2841
Crosstalk	213-2	5952-2844
Interchannel Time Displacement Error	213-3	5952-2848

3964A, 3968A Transport Specifications

Tape width: 1/4 inch (6.3 mm)

Reel size: Standard 7-inch (18 cm) plastic reel, totally enclosed by reel cover

Heads:

3964A: One 4-track record and one 4-track reproduce

3968A: One 8-track record and one 8-track reproduce

Tape Speed* (ips)	15	7 1/2	3 3/4	1 7/8	1 5/16	1 5/32
Flutter (% p-p)	0.35	0.35	0.40	0.50	0.70	1.5
Time base error (s)*	± 4	± 5	± 7.5	± 15	± 25	± 50
Start time (s) (typical)	3	1.5	0.9	0.5	0.5	0.5
Tape speed accuracy (s)	0.2	0.2	0.2	0.2	0.2	0.2

*Tape servo operation

Tape motion controls: Pushbutton selectable Forward Record, Reverse Record, Forward Play, Reverse Play, Fast Forward, Fast Rewind, and Stop

EOT sensing: Tape drive stops automatically at the end of tape (EOT)

Reel revolution counter: 4-digit counter with pushbutton reset



RECORDERS & PRINTERS

Instrumentation Tape Recorders & Degausser

Models 3964A, 3968A, 13064A Degausser (Cont.)

FM Record/Reproduce Specifications¹

Tape Speed	Passband ^a (Hz)	Signal-to-noise ^a Ratio	
		3964A	3968A
15	DC-5000	48	46
7 1/2	DC-2500	48	46
3 3/4	DC-1250	48	46
1 7/8	DC-625	46	46
15/16	DC-312	44	44
15/32	DC-156	40	40

- Based on use of 3M-890 tape or equivalent
- Frequency response over passband is ± 1.0 dB referenced to 10% of upper band edge frequency
- Signal measured with carrier deviation $\pm 40\%$ of upper passband without flutter compensation. Output filters of reproduce amplifiers selected for constant amplitude response. May also be selected for linear phase (transient) response

Flutter compensation: Can improve signal-to-noise by up to 4 dB under static conditions and as much as 12 dB under conditions of vibration. Selected by rear panel switch.

Distortion: Total harmonic distortion $< 1.2\%$ @ 15 to 1 1/2 ips, $< 2\%$ @ 15/16 to 15/32 ips.

Linearity: $\pm 1.0\%$ of peak-to-peak output for best straight line through zero at $\pm 40\%$ deviation

DC drift: $\pm 0.1\%$ (max) of full scale output per $^{\circ}\text{C}$

Input level: 1 V to 30 V (peak-to-peak); continuously adjustable

Input impedance: 100 k Ω nominal, shunted by < 100 pF single-ended

Output level: 1 to 5 V (peak-to-peak); continuously adjustable

Load impedance: Minimum load impedance 660 ohms

Direct Record/Reproduce Specifications¹

Tape Speed (ips)	Passband (± 3 dB) ^a		S/N Ratio (dB) ^a	
	3964A	3968A	3964A	3968A
15	70-64000 Hz	500-64000 Hz	38	36
7 1/2	50-32000 Hz	250-32000 Hz	38	36
3 3/4	50-16000 Hz	100-16000 Hz	38	36
1 7/8	50-8000 Hz	100-8000 Hz	38	36
15/16	50-4000 Hz	100-4000 Hz	38	35
15/32	50-2010 Hz	100-2000 Hz	37	35

- Based on the use of 3M-890 tape or equivalent
- Reference to 10% of upper band edge
- Referenced to a 600 Hz sine wave with a maximum of 1% third harmonic distortion when reproduced at 3 3/4 ips

Input level: 1 V to 30 V (p-p); continuously adjustable

Input impedance: 100 k Ω nominal, single-ended

Output level: 0.5 to 5 V (p-p); continuously adjustable

Load impedance: Minimum load impedance 600 ohms

Calibrator: Internal signal source, peak AC and \pm DC levels of 0, 1.0, 1.414, 2.5, 5.0, and 10.0 volts $\pm 2\%$

Meter modes: Peak AC or DC, input or output

3964A, 3968A General Specifications

Size:

3964A: 400 H x 427 W x 256 mm D (15.7 x 16.8 x 10.1 in.)

3968A: 445 H x 427 W x 256 mm D (17.5 x 16.8 x 10.1 in.)

Weight: 3964A: 29.5 kg (65 lb). 3968A: 31.3 kg (69 lb)

Power requirements: 100, 120, 220, or 240 V, $+5\%$, -10% , 48-440 Hz; 110 W average (except Opt 009, 010, 48-66 Hz)

Temperature: storage, -40°C to 75°C ; operating, 0°C to 55°C ; tape limit, 10°C to 40°C

Altitude: Storage, 15240 m (50000 ft); operating, 4500 m (15000 ft)

Humidity: The system, excluding tape limitations, will operate from 10% to 95% RH (25°C to 40°C), non-condensing

Shock: 30 g maximum (11 ms) non-operating

Mounting: Rack mounting kit for equipment racks, 19-inch



13064A

13064A Tape Degausser Specifications

Tape size: 1/4-inch (6.33 mm) tape on reels up to 10 1/2 inch (266 mm) in diameter

Erase: 60 dB minimum

Duty Cycle: one minute ON - three minutes OFF

Size: 67 H x 133 W x 171 mm D (2.6 x 5.25 x 6.75 in.)

Weight: approximately 4.3 kg (9 1/2 lb)

Power requirements: 115 V AC $\pm 10\%$, 50-60 Hz (Opt 001); 230 V AC $\pm 10\%$, 50-60 Hz (Opt 002)

3964A, 3968A Options

Record/Reproduce Channel Data Card Options.

Option provides one data card. Specify one option for each channel, up to 4 for 3964A, up to 8 for 3968A.

001 FM data card, standard \$430

030 FM data card, medical (must order Opt 009 or 010) \$430

002 Direct data card, standard \$400

031 Direct data card, medical (must order Opt 009 or 010) \$400

Medical ITR Options

009 Medical version with white paint \$450

010 Medical version with standard paint \$385

Other Options

Specify no more than one of each option per mainframe

003 Rear panel with BNC input/output connectors for each channel.

3964A \$85

3968A \$105

004 Locking knob set (screwdriver adjustable) \$45

005 Metric speed annotation on pushbuttons N/C

007 HP-IB remote control of speeds and mode \$415

024 Loop adapter (accommodates 5 to 30-ft loop) \$880

026 Slides for 19 in. racks \$120

027 Slides for HP cabinets \$175

041 IRIG servo reference frequency \$195

070 Overlap. For two units. Provides automatic play/record commands for second recorder when first unit tape is low \$330

Ordering Information

3964A 4-channel instrumentation tape recorder \$7100

3968A 8-channel instrumentation tape recorder \$9300

13064A Tape degausser (specify Option 001 for 115 V AC or 002 for 230V AC, N/C for options) \$140

13107A Transit case for 3964A \$420

13106A Transit case for 3968A \$420

RECORDERS & PRINTERS

Alphanumeric, 20 Column Thermal Printer

Model 5150A

303



- Silent operation
- Optional scanner and clock
- Alphanumeric

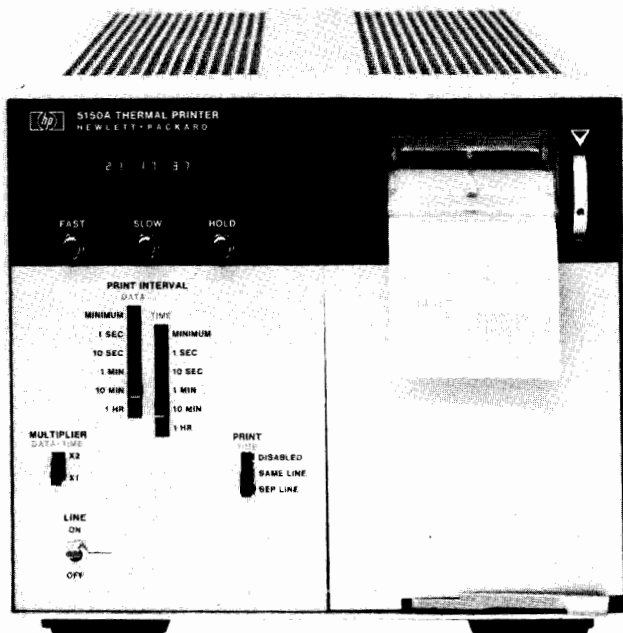

5150A Opt 004

General

The 5150A Thermal Printer is a versatile instrumentation printer designed to accept and record up to 20 columns of data from most HP digital instruments. Because it uses a thermal printing technique, it is extraordinarily quiet while in operation. Two input interfaces are available (one must be specified with the order) to allow data input from the HP Interface Bus (use Option 001) or from BCD-coded sources (use Option 002). Other options which add to the flexibility of this printer are the Option 003 Scanner, which can sequentially address and interrogate up to 13 instruments on the HP-IB, and the Option 004 Clock, which can be used with either the HP-IB or BCD Interfaces.

Opt 001 HP-IB Interface

With Option 001 installed, the printer can accept up to 20 ASCII characters per line via the HP-IB. Inputs are interpreted according to the 64 member upper-case ASCII character set. With this interface, the printer can also serve as an "addressable listener" in a controller-based HP-IB system. HP-IB cable not supplied.

Opt 002 BCD Interface

With Option 002 installed, the printer will accept 10 columns of TTL-level BCD data. Two Options 002's may be installed for 20-column print-out from one or two sources. The standard 16-member character set consists of 0 through 9, +, -, V, A, R, and [blank]. Special characters set which draw from the 64-character upper-case ASCII set may also be specified.

Opt 003 Scanner

With both Options 001 and 003 installed, the printers can log data from up to 13 instruments on the HP-IB. Operation is asynchronous; that is, the printer will address the lowest address instrument, wait for data, print, then go to the next instrument.

Opt 004 Clock

Used with either the HP-IB Interface or BCD Interface, this option gives the printer two additional capabilities: it can control the elapsed time between successive data printouts, and it can print the time of day immediately following each data printout. When used with the Option 003 Scanner, the clock controls the elapsed time between the initiation of successive scans.

Specifications

Character printer: 5 x 7 dot matrix.

Printing rate: 3 lines per second.

Line spacing: approximately 2.5 lines per cm. (6 lines per inch).

Paper advance mechanism: direct drive, stepping motor.

Paper: thermal sensitive, in rolls (one roll supplied).

Operating environment: 0°C to 50°C temperature; 95% relative humidity.

Power: 100, 120, 220, or 240 volts, 48 to 440 Hz (50 or 60 Hz only for Opt 004), 100 VA.

Dimensions: half-rack module, 178 mm H x 216 mm W x 356 mm D (7" x 8½" x 14¼").

Weight: approx. 7 kg (16 lb) (5150A +1 option).

HP-IB Interface (Opt 001)

Columns: 20.

Printed character set: 64 ASCII characters (columns 2, 3, 4, and 5 of ANSI X3.4-1968, except "↑" in column 5, row 14).

Input Logic Levels: TTL (low <0.4 V, high >2.5 V).

Data format: byte-serial with storage, compatible with HP-IB.

Inhibit (output): holds NRFD line of HP Interface Bus low following receipt of either CR or LF (selectable) until print is completed. This interval is approx. 250 ms minimum, or the duration of Option 004 Clock data print interval with clock in Hold mode.

BCD Interface (Opt 002)

Columns: 10 (20 columns with two Options 002's installed).

Character set: 0 through 9, +, -, V, A, R, and [blank].

Input logic levels: TTL (low <0.4 V, high >2.5 V).

Data format: parallel BCD (8421); switch selects + or - true logic.

Print command: pos. or neg. TTL transition; 2 kΩ input impedance.

Inhibit (output): + or -, same levels as above; remains at true level until print is completed (approx. 250 ms minimum) or during Option 004 Clock data print interval with clock in Hold mode.

Scanner (Opt 003)

Instruments scanned: 1 to 13.

Cycle time of scan: limited by the slowest of (a) response of instruments scanned, (b) 3 samples per second, or (c) Data Print Interval setting on Option 004 Clock.

Compatibility: HP Interface Bus (utilizes ASCII code).

Identifier: labels data line of each instrument with letters A-M.

Protect feature: bypasses non-responding instrument after 3 sec.

Clock (Opt 004)

Data print interval: selectable by front panel switches: minimum, 1 s, 2 s, 10 s, 20 s, 1 min, 2 min, 10 min, 20 min, 1 hr, 2 hrs. Print interval will be that of input device if it is slower than the selected interval.

Time print interval: selectable by front panel switch, same intervals as above (intervals shorter than data interval prevented).

Time print format: selectable by front panel switch: disabled, same as data, or separate line from data.

Display: six-digit, seven-segment LED display of hours, minutes, seconds (00:00:00 to 23:59:59); settable via front panel switches.

Time base: line frequency (50 or 60 Hz, selectable by jumper).

Operating Supplies/Accessories

	Price
9281-0401 6-Roll box of paper, 76 meters (250 feet) each	\$15
10533A BCD Interface Cable for 5300A	\$325
10833A Interface Bus Cable, 1 m (3.3 ft)	\$70
10833B Interface Bus Cable, 2 m (6.6 ft)	\$75
10833C Interface Bus Cable, 4 m (13.2 ft)	\$85
10833D Interface Bus Cable, 0.5 m (1.6 ft)	\$70

Options

001: HP-IB Interface	add \$325
002: BCD Interface	add \$225
003: Scanner	add \$325
004: Clock	add \$450
005: BCD Interface Cable (562A-16C)	add \$125
910: Extra manual	add \$22.50

5150A Thermal Printer

\$1300

Hewlett-Packard offers frequency standards and clocks which provide accurate frequency, time interval and timekeeping capabilities. Further, Hewlett-Packard standards provide means for comparing these quantities against national standards such as the National Bureau of Standards (NBS) and the U.S. Naval Observatory. Units of frequency or time cannot be kept in a vault for ready reference. They must be generated for each use, hence be regularly compared against recognized primary standards.

Frequency standard and clock systems manufactured by Hewlett-Packard are used for control and calibration at observatories, national centers for measurement standards, physical research laboratories, missile and satellite tracking stations, communication systems, radio navigation systems, manufacturing plants and radio monitoring and transmitting stations.

Types of Frequency Standards

At the present time, three types of frequency standards are in common use. These are:

1. The cesium atomic beam controlled oscillator.
2. The rubidium gas cell controlled oscillator, and
3. The quartz crystal oscillator.

Hewlett-Packard manufactures all three types of frequency standards. Of these three standards, the first is a primary frequency standard and the last two are secondary frequency standards. The distinction between a primary standard and a secondary standard is that the primary standard does not require any other reference for calibration; whereas the secondary standard requires calibrations both during manufacturing and at intervals during use depending on the accuracy desired.

Cesium Beam Frequency Standard

Cesium beam standards are in use wherever the goal is a very high accuracy primary frequency standard. In fact, the NBS frequency standard itself is of the cesium beam type. The cesium beam standard is an atomic resonance device which provides access to one of nature's invariant frequencies in accord with the principles of quantum mechanics. The cesium standard is a true primary standard and requires no other reference for calibration.

The HP Model 5061A is a portable cesium beam standard proved capable of realizing the cesium transition frequency approaching levels of accuracy and long term stability achieved by large-scale laboratory models. Recent beam tube improvements have made the short-term stability comparable to that of

TABLE 1 Comparison of Frequency Standards

Standard	Principal construction feature	Principal advantage
Cesium Atomic Beam Resonator Controlled Oscillator.	Beam of free Cesium atoms, spatially state selected, is subjected to a microwave signal at resonance frequency.	High intrinsic reproducibility and long-term stability. Designated as primary standard for definition of time interval.
Rubidium Gas Cell Resonator Controlled Oscillator.	Gas buffered resonance cell with optically pumped state selection.	Compact and light weight. High degree of short-term stability.
Quartz Crystal Oscillator.	Piezoelectrically active quartz crystal with electronic stabilization.	Very compact, light and rugged. Inexpensive.

the rubidium frequency standard. With this improved performance, cesium standards now have the capability of rapid measurement to high precision along with the excellent long term stability necessary for timekeeping.

Rubidium Frequency Standard

Rubidium frequency standards feature a high order of both short-term and long-term frequency stability. These are both important in certain fields such as deep-space communications, satellite ranging, and doppler radar.

Rubidium standards are similar to cesium beam standards in that an atomic resonant element prevents drift of a quartz oscillator through a frequency lock-loop. Yet the rubidium gas cell is dependent upon gas mixture and gas pressure in the cell. It must be calibrated and then it is subject to a small degree of drift. The drift is typically 100 times less than the best quartz crystal standard.

Quartz Crystal Oscillators

Quartz oscillators are used in virtually every frequency control application including atomic standards. The excellent short-term stability and spectral purity of the quartz oscillators used in Hewlett-Packard atomic standards contribute to the high quality of the output signal of these standards. For less demanding applications where some long-term drift can be tolerated, quartz oscillators are used as independent frequency sources. The quartz oscillator designs have improved over the years to provide a relatively low cost, small-size source of frequency.

However, an inherent characteristic of crystal oscillators is that their resonant frequency changes with time. After an initial aging period of a few days to a month, the rate-of-change of frequency, or aging rate, is almost constant. Over a long period the accumulated drift could amount to a serious error, and periodic frequency checks are needed to maintain an accurate quartz crystal frequency standard.

Stability

Stability is specified in two ways. Long term stability refers to slow changes in the average frequency with time due to secular

changes in the resonator and is usually expressed as a ratio, $\Delta f/f$ for a given period of time. For quartz oscillators this is often termed "aging rate" and specified in "parts per day." Rubidium standards being more stable are specified in "parts per month." On the other hand, cesium beam standards are primary units with no systematic drift. Therefore, the frequency of these primary standards is guaranteed to a specified accuracy.

Short-term stability refers to changes in frequency over a time sufficiently short so that change in frequency due to long term effects is negligible.

Since short-term stability is a very broad term, it may refer to a number of different measurement methods and types of instability. In order to be clear when testing or specifying frequency standards, there are two classes of variations and two classes of measurement methods to be considered. The two classes of frequency variation are random, and non-random (or systematic, periodic, discrete, secular). The two classes of measurement are time domain (example: two sample deviation) and frequency domain (example: spectral density). Each of these measurement methods responds to both random and non-random variations.

Time Domain

The subcommittee on Frequency Stability of the Technical Committee on Frequency and Time of the IEEE Group on Instrumentation and Measurement* has established a standard method of measuring frequency stability in the time domain as the rms of the differences between adjacent pairs of frequency measurements, normalized, called the two-sample-deviation (also square root of Allan variance). Figure 1 is a comparison of the two-sample-deviation of various frequency standards.

Frequency Domain

In a frequency domain measurement, the spectrum of phase or frequency variations can be plotted, hence the term, spectral purity.

* Barnes et al. (May 1971) IEEE Transactions on Instruments & Measurements Vol. 1M-20, 105-120.

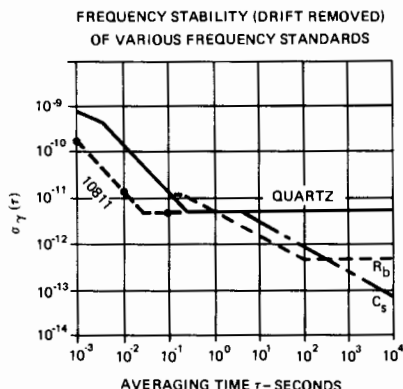

Figure 1. Time Domain stability of various standards.

Spectral purity is the degree to which a signal is coherent, or, expressed in another way, a single frequency with a minimum of sideband noise power. It is very desirable to have high spectral purity in a standard signal. This is especially important in applications where the standard frequency is multiplied to very high or microwave frequencies (so that the frequency spectrum of the multiplied signal will be reasonably narrow).

The signal and its frequency spectrum are analogous to a frequency modulated wave where the total power is constant. If the frequency multiplying device is broadband, the ratio of the total sideband power to the signal power increases as the square of the multiplying factor. With frequency multiplication the signal-to-noise ratio will be degraded 6 dB per octave and 20 dB per decade.

Frequency domain measurements respond to both random and non-random variations, but in many cases, the effects are more readily separated and identified. For example, clearly separate measurements can be made of white noise combined with discrete spectral components ("bright lines").

The recommended specifications for the frequency domain are S_y and S_ϕ . The widely used \mathcal{L} or single-sideband phase-noise-to-signal-ratio is, for low modulation index, one half of S_ϕ (or $\mathcal{L}(f) \sim S_\phi(f) - 3$ dB).

Hewlett-Packard oscillators are designed to give high spectral purity. Figure 2 shows the performance of the HP 5061A, Opt. 004 Cesium Beam Atomic Frequency Standard.

Frequency Standards and Clocks

Frequency standards and clocks have no fundamental differences—they are based

upon dual aspects of the same phenomenon. Time and frequency are intangible quantities which can be measured only with respect to some physical quantity. The basic unit of time, the second, is defined as the duration of 9,192,631,770 periods of transition within the cesium atom. Conversely an unknown frequency is determined by counting the number of cycles over the period of a second. The Master Clock at the U.S. Naval Observatory, one of the world's most accurate clocks, is made of an ensemble of more than a dozen Hewlett-Packard cesium beam frequency standards. The USNO directly controls the distribution of precise time and time interval (frequency) from Naval radio stations, Loran-C (operated by U.S. Coast Guard), Omega and Satellite Navigation Systems. Hewlett-Packard portable cesium standards, "flying clocks," are used to periodically check the synchronization between these stations and the Master Clock.

Hewlett-Packard cesium beam standards are widely used to drive precision clocks because of the extremely good long-term stability and reliability of this primary standard. If a quartz oscillator or other secondary standard is used, it must be evaluated for rate of drift and be corrected periodically.

Time Scale

The time interval of the atomic time scale is the International Second, defined in October 1967 by the Thirteenth General Conference of Weight and Measures. Since January 1972 the frequency offset between UTC and Atomic Time has been zero and the UTC time scale is kept in synchronism with the rotation of the earth to within ± 0.9 second by step-time adjustments of exactly 1 second, when needed (see Hewlett-Packard Application Note 52-2).

The U.S. National Bureau of Standards (NBS) and USNO provide the official basis for Standard Time for the United States. The UTC signal is broadcast from the NBS stations WWV and WWVB and by several other stations throughout the world. (See Hewlett-Packard Application Note 52-1, Fundamentals of Time and Frequency Standards, for a list of stations broadcasting time signals).

Standby Power Supplies

Minimum down-time, important for any system, is vital to a time standard. Its worth depends directly on continuity of operation. Noninterrupted operation is also important to ultra-precise quartz oscillators.

Hewlett-Packard standby power supplies ensure continued operation despite line interruptions, and operate over a range of ac line voltage to supply regulated dc to operate frequency standards and frequency dividers and clocks. The batteries in the supplies assume the full load immediately when ac power fails.

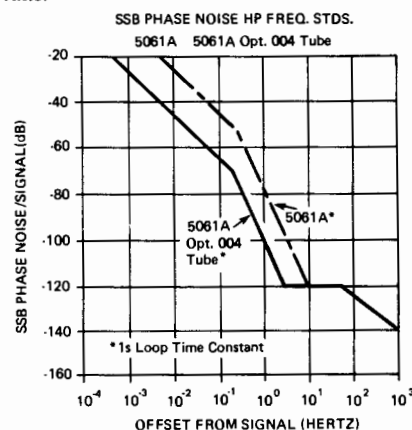

Figure 2. 5061A Phase Noise

Hewlett-Packard Time and Frequency Standard

The Hewlett-Packard House Standard at the Santa Clara Division consists of an ensemble of four Hewlett-Packard Cesium Beam Standards each with the Option 004 High Performance Tube.

The standard is compared to the U.S. Naval Observatory Master Clock in Washington, D.C. by means of Loran C and TV Line 10 measurements through the USASTRAT-COM satellite system. It is also compared with the U.S. National Bureau of Standards Frequency Standard (NBS FS) at Boulder, Colorado by means of Loran-C through the Naval Observatory. The frequency uncertainty of the standard is within a few parts in 10^{13} with respect to the standards maintained by the NBS and the USNO.

Time is maintained relative to the Naval Observatory and the National Bureau of Standards master clocks to an accuracy of better than ± 1.0 microseconds. This accuracy is verified with flying clock trips from the Naval Observatory to both Hewlett-Packard Santa Clara Division and Hewlett-Packard Geneva. Both locations have been designated U.S. Naval Observatory Time Reference Stations.

FREQUENCY & TIME STANDARDS

Component Oscillator

Models 10811A, B

- New "SC" crystal cut
- Excellent spectral purity
- Low power
- Fast warm-up
- High reliability
- Rugged
- Compact
- Field repairable

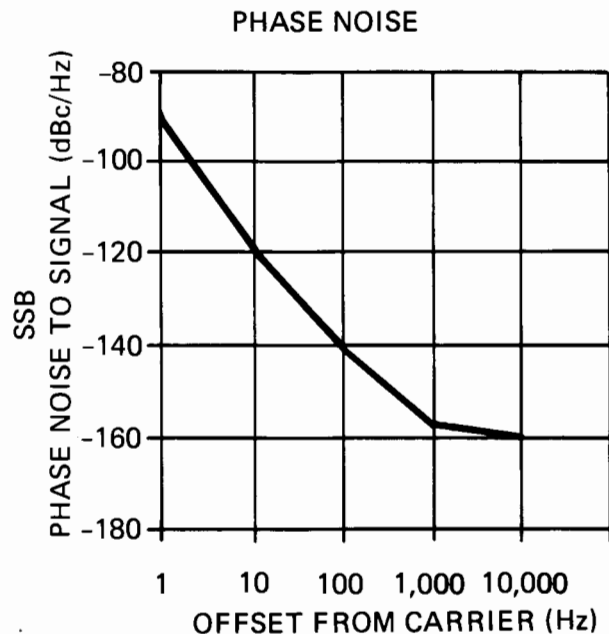

Description

The 10811 Crystal Oscillators were developed by Hewlett-Packard to meet the ever increasing requirements for compact, high stability oscillators in test equipment and systems. These oscillators are used extensively in Hewlett-Packard test instruments and contribute in part to the superior performance of those instruments. Their excellent short-term stability and high spectral purity are especially desirable in applications where multiplication and synthesis are used to generate microwave frequencies. Rugged construction and high quality components assure high reliability and optimum performance. With the extremely low aging rate of these oscillators, significant cost savings can be realized at the end user by reducing the frequency of calibration needed to stay within FCC accuracy requirements.

The crystal for the oscillator is supported by a rugged mounting in a cold-welded, high bake-out enclosure. The housing around the crystal enclosure is massive with high thermal conductivity which contributes both to rapid warmup and excellent temperature stability. The oscillator, AGC amplifier and oven control circuits are all inside a thermally insulated oven. Rigid plastic foam with extremely low thermal conductivity is used to provide thermal insulation and firm mechanical support for the oven enclosure.

The 10811 oscillator has lower power consumption than previous designs due to a highly efficient new oven design. The oven controller is of the dc proportional type which results in very good phase noise and time domain stability specifications.

The differences between the A and B versions are primarily in the type of external connectors used. The A version uses a PC-board connector for all external connections; the B version uses SMB snap-on rf connectors for the 10 MHz output and the EFC input and solder-type connectors for the remainder of the connections. Additionally, the B version has provision for shock mounting.

The oscillators are ideally suited for use in communication and navigation systems, synthesizers, time-code generators, counters and spectrum analyzers. The 10 MHz output frequency is a convenient starting point since it is easily divided or multiplied.

A screwdriver adjustment through the top of the oven enclosure permits frequency adjustment over a range of 2×10^{-6} (20 Hz), yet the control is fine enough to allow adjustment to better than 1×10^{-9} (0.01 Hz). Frequency can also be controlled electronically (EFC) over a 1 Hz range with an externally applied voltage.

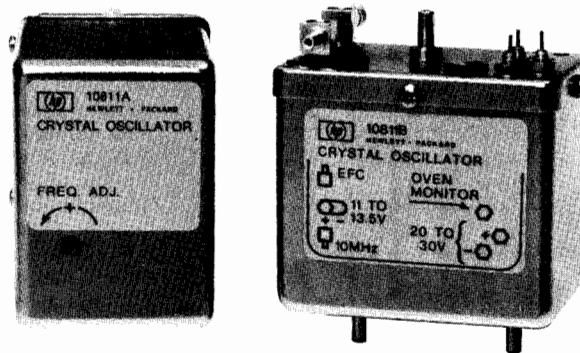

Specifications (Abbreviated)

Output: 10 MHz

1.0 ± 0.2 V rms into 1000 Ω , or 0.55 ± 0.05 V rms into 50 Ω

Aging rate (after 24-hour warmup): $< 5 \times 10^{-10}$ /day.

Short term stability:

Averaging time

10^{-3} s	1.5×10^{-10}
10^{-2} s	1.5×10^{-11}
10^{-1} s	5×10^{-12}
10^0 s	5×10^{-12}
10^1 s	5×10^{-12}
10^2 s	1×10^{-11}

Temperature: $< 2.5 \times 10^{-9}$ (0 to 71°C)
 $< 4.5 \times 10^{-9}$ (-55 to 71°C)

Load: $< 5 \times 10^{-10}$ for a $\pm 10\%$ change in 50 Ω load or $\pm 25\%$ change in 1000 Ω load.

Warmup: within 5×10^{-9} of final value 10 min. after turn on.

Frequency adjustment

Coarse: $> 2 \times 10^{-6}$ (20 Hz)

Fine (EFC): $> 1 \times 10^{-7}$ (1 Hz)

Harmonic distortion: > 25 dB from rated output

Spurious phase modulation: down more than 100 dB from rated output

SSB phase noise ratio (1 Hz bw)

For offsets of:

1 Hz:	-90 dBc
10 Hz:	-120 dBc
100 Hz:	-140 dBc
1000 Hz:	-157 dBc
10000 Hz:	-160 dBc

Power: 2W

Case size: 72 H x 52 W x 62 mm D (2.8" x 2" x 2.4").

Weight: 0.31 kg

	Price	
Quantity	10811A	10811B
1 to 4:	\$925 ea	\$1050 ea
5 to 9:	\$888 ea	\$1008 ea
10 to 24:	\$851 ea	\$ 966 ea
25 to 49:	\$777 ea	\$ 882 ea

- High spectral purity
- Well-buffered outputs
- Aging $< 5 \times 10^{-10}$ per day

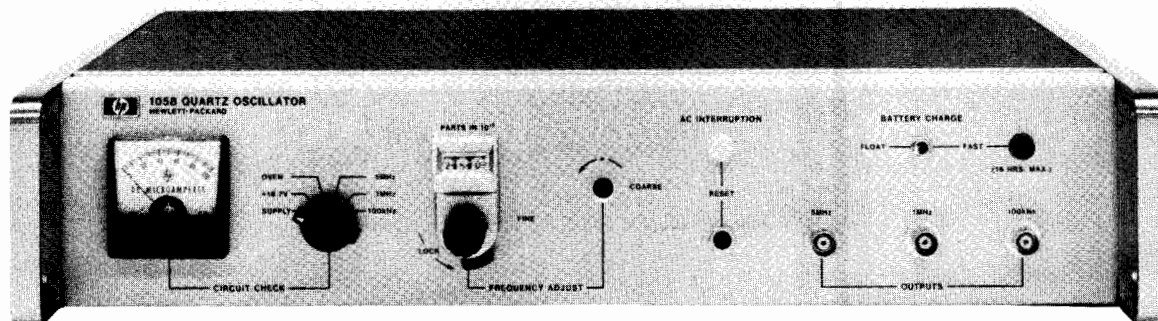

105B

Models 105A and B Quartz Oscillators provide state-of-the-art performance in precision frequency and time systems because of their excellent long and short term stability characteristics, spectrally pure outputs, unexcelled reliability, and ability to operate under a wide range of environmental conditions. They fill a need for a small and economical yet highly stable precision quartz oscillator for frequency and time standards. Both models can be operated from the ac line; the 105B has a built-in 8-hour standby battery for uninterrupted operation should line power fail. Both have 5 MHz, 1 MHz and 100 kHz buffered sinusoidal outputs with excellent short term stability (5 parts in 10^{12} rms for 1 s averaging time) and aging rate (< 5 parts in 10^{10} per day).

The 105A/B features rapid warm-up. Typically, the oscillator will be within 5 parts in 10^9 of the final frequency in 15 minutes after an "off" period of 24 hours. The basis of these oscillators is an extremely stable "SC" cut quartz crystal developed by Hewlett-Packard. New technologies in the crystal mounting and packaging have resulted in a cleaner crystal which in turn has a lower aging rate. The crystal, oscillator and AGC circuit are all enclosed in a proportional oven which reduces the temperature effects on these components and circuits.

The package containing the oven enclosed crystal oscillator with AGC circuit and buffer amplifier are available separately as a component oscillator, the 10811A, for use in equipment where a high quality 10 MHz source is required. Details are available from Hewlett-Packard sales offices.

Particular care was taken to provide a spectrally pure 5 MHz output which, when multiplied high into the microwave region, provides signals with spectra only a few cycles wide. Spectra less than 1 Hz wide can be obtained in X-band (8.2 to 12.4 GHz). The stability and purity of the 5 MHz output make it suitable for doppler measurements, microwave spectroscopy, and similar applications where the reference frequency must be multiplied by a large factor.

Specifications

Outputs: 5 MHz, 1 MHz, 100 kHz; 1 V rms into 50 Ω front and rear connectors.

Clock output: 1 MHz or 100 kHz; 0.5 V rms into 1 k Ω , rear connector. Normally supplied wired for 1 MHz output.

Frequency Stability

Aging rate: $< 5 \times 10^{-10}$ per 24 hours.

Short-term stability: for 5 MHz output only.

τ (sec)	$\sigma\Delta f/f(2,\tau)$
10^{-2}	1.5×10^{-10}
10^{-1}	1.5×10^{-11}
10^0	5×10^{-12}

Temperature: $< 2.5 \times 10^{-9}$ total change 0°C to 50°C .

Load: $\pm 1 \times 10^{-10}$ open to short circuit, 50 Ω R, L or C load change.

Supply voltage: $\pm 5 \times 10^{-11}$ for 22–30 V dc from 26 V dc reference and for 115/230 V $\pm 10\%$.

Warm-up (at 25°C): to within 5×10^{-9} of final frequency in 15 min.

Distortion (5 MHz, 1 MHz, 100 kHz) below rated output

Harmonic: > 40 dB.

Non-harmonic: > 80 dB.

Frequency Adjustments

Fine: $\pm 5 \times 10^{-8}$ range with digital dial reading parts in 10^{10} .

Coarse: 1×10^{-6} front panel screwdriver control.

Phase locking: external +5 V to -5 V allows $> 2 \times 10^{-8}$ frequency control for locking to external source.

Environmental

Temperature, operating: 0°C to $+50^\circ\text{C}$.

Temperature, storage: -40°C to $+75^\circ\text{C}$ ($+50^\circ$ for 105B).

Altitude: 15.24 km (50,000 ft.).

Shock: MIL-T-21200 (30 Gs).

Vibration: MIL-STD-167 and MIL-T-21200.

Electromagnetic compatibility (EMC): MIL-I-6181D.

Standby supply capacity: model 105B only, 6 hours at 25°C ambient temperatures.

Power requirements: 115/230 V $\pm 10\%$, 50–400 Hz at 18 W (70 W warm-up) for 105A. For 105B add 1 W for float charge and 12 W for fast charge. 22–30 V dc at 8 W (16 W warm-up).

Size: 88 H x 425 W x 286 mm D ($3\frac{15}{32}$ " x $16\frac{3}{4}$ " x $11\frac{1}{4}$ ").

Weight: 105A—net, 8 kg (16 lb). Shipping, 10.5 kg (23 lb). 105B—net, 11 kg (24 lb). Shipping, 14 kg (31 lb).

Options

908: Rack Flange Kit

910: Extra manual

Price

add \$25

add \$15

Ordering Information

105A Quartz Oscillators

\$5000

105B Quartz Oscillators

\$5750

FREQUENCY & TIME STANDARDS

Atomic Frequency Standards

Models 5061A, 5065A

5061A

- Primary standard, $\pm 1 \times 10^{-11}$ accuracy
- Proven reliability
- World-wide usage

5061A, Opt 004

- Accuracy $\pm 7 \times 10^{-12}$
- Settability $\pm 1 \times 10^{-13}$
- Time domain stability 5×10^{-12} (1 s avg)

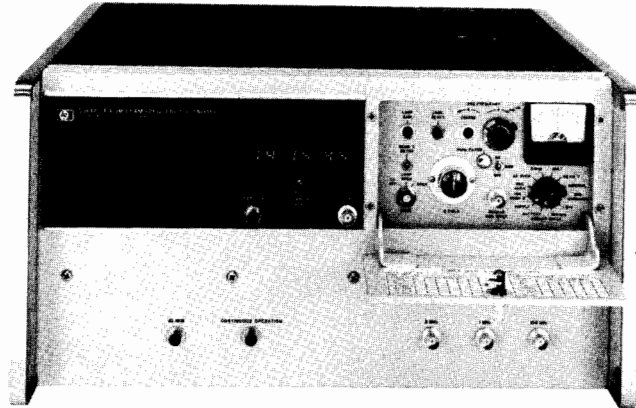

5061A

Introduction

Hewlett-Packard Atomic Frequency Standards have become the world-wide standards for frequency and time keeping since the introduction of the 5060A Cesium Standards in 1964. The user has a choice of three different frequency standards to satisfy a wide variety of applications:

- 1) 5061A Cesium Beam Frequency Standard. This standard with an accuracy of $\pm 1 \times 10^{-11}$ was introduced in 1967 to replace the 5060A. The high accuracy and excellent reliability of these units have gained world-wide acceptance of HP frequency standards.
- 2) 5061A with Option 004 High Performance Cesium Beam Tube. With the unique design features in this improved Cesium Beam Tube, the 5061A accuracy is $\pm 7 \times 10^{-12}$ and short term stability is improved by a factor of 10.
- 3) 5065A Rubidium Frequency Standard. This instrument features excellent long and short term stability performance at approximately one-half the cost of a cesium standard.

The units are described in detail on the following pages and the specifications are combined in a table to facilitate the comparison and selection of the best unit to suit the user's application.

Principles of Operation

The basic block diagram of both cesium and rubidium standards is the same (see Figure 1). The output of the 5 MHz crystal oscillator

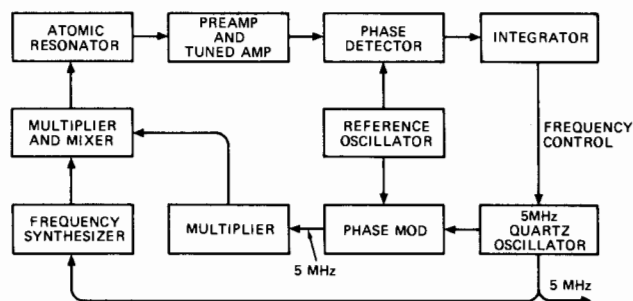

Figure 1. Block diagram of atomic frequency standards.

is multiplied and synthesized to the atomic resonance frequency (6834+ MHz for rubidium and 9192+ MHz for cesium). The signal is frequency modulated to sweep through the atomic resonance frequency causing the beam intensity in the cesium tube or transmitted light through the rubidium cell to vary. The output signal is amplified

and through a phase detector controls the frequency of a low noise 5 MHz quartz crystal oscillator. The oscillator provides the 5 MHz output. Dividers produce 1 MHz and 100 kHz outputs.

The invariant resonance frequency of the cesium atoms passing through the microwave cavity maintain the output frequency of the cesium standard constant to extremely high accuracy. The accuracy is in part a function of the microwave cavity length and is highest in the 5061A with the long cavity of the high performance beam tube.

In the rubidium standard a buffer gas is required to reduce collisions between the rubidium atoms in the gas cell and the resonant frequency varies slightly with the pressure of the buffer gas. As a result, the rubidium standard has to be calibrated and the frequency drifts slowly with time because of small changes in gas pressure and other effects within the rubidium cell and lamp. Offsetting this disadvantage are: 1) high signal-to-noise ratio of the rubidium cell output which results in excellent short term stability and; 2) a lower cost standard because of the simpler rubidium cell and associated electronics.

Each of the instruments has front panel controls, a circuit check switch and meter for monitoring performance. These and other controls are protected by a panel door. Front panel lights indicate any interruption of continuous operation and that the crystal oscillator is locked to the atomic resonance.

Applications: starting with their initial usage as reference standards in national laboratories the applications of HP atomic standards have expanded to include use in operational systems such as the Loran C and Omega navigation transmitters, satellite tracking and guidance stations, very long base line interferometers, navigation receivers based on direct distance measurement (Loran Rho-Rho), geophysical survey positioning systems and communications systems. Precise timing for frequency control is required for some secure communications systems and to improve efficiency of PCM and spread spectrum systems.

Cesium standard accuracy: the cesium beam standard is a primary frequency standard. A cesium beam tube carefully constructed along with the required supporting electronics will, when independently aligned, put out the correct frequency within very narrow limits. The frequency spread of the output for over 250 independently aligned 5061A standards with the standard beam tube is shown in Figure 2. It can be seen from this data that the frequency perturbations in the standard beam tube are so small that all the units are within $\pm 5 \times 10^{-12}$ of each other and of NBS frequency. The one sigma standard deviation is 1×10^{-12} between units. This performance is intrinsic to the 5061A and is achieved without calibration. The absolute accuracy, intrinsic reproducibility and absence of any perceptible long-term drift or aging are important advantages of cesium standards and assure that the output frequency of a cesium standard is always within the specific accuracy.

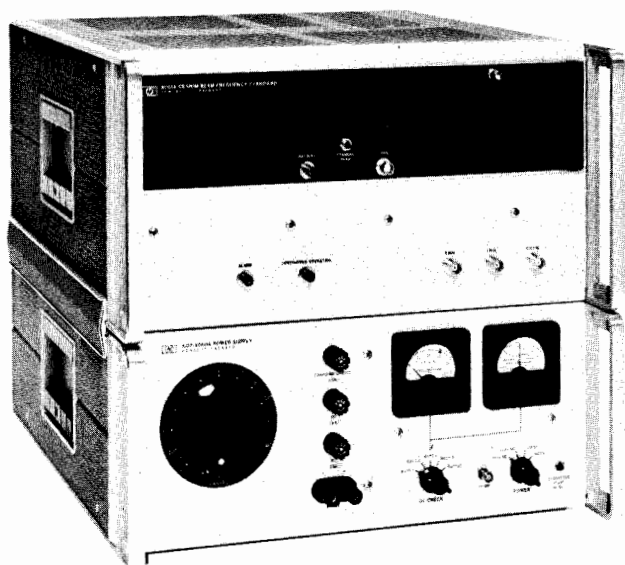

E21-5061A

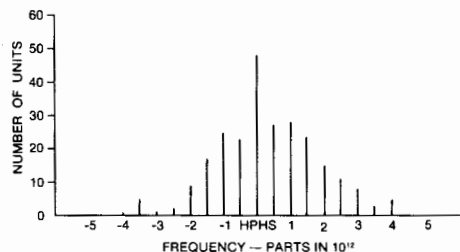

Figure 2. Frequency of independently aligned 5061A Cesium Beam Standards with standard beam tube.

5061A Cesium Beam Standard

The first Hewlett-Packard Cesium Beam Standard, the 5060A, was introduced in 1964. This was followed in 1967 with the improved 5061A and in 1973 with the high performance beam tube option for the 5061A. Since this time the accuracy and reliability of Hewlett-Packard cesium beam standards has been demonstrated and these standards have become the world-wide standard for frequency and time keeping. The 5061A has provision for an optional digital divider and reliable, easy-to-read LED clock (Option 001) and for a battery with ½ hour standby power capacity with automatic charging (Option 002).

Reliability and warranty: over 60 million operation hours have proven the performance and reliability of Hewlett-Packard cesium beam standards in various world-wide applications. The units have provided dependable microsecond accuracy in aircraft, ship and fixed environments.

A three-year warranty on the 5061A standard cesium beam tube is provided as a result of proven field reliability over an extended period. This warranty includes replacement of the cesium beam tube if it should fail within the warranty period. Typically, beam tube life has been in excess of five years.

5061A with Opt 004, High Performance Cesium Beam Tube

The Hewlett-Packard Model 5061A primary frequency standard with the Option 004 Cesium Beam Tube offers increased stability and accuracy in the instrument which has become the worldwide standard

of frequency and time keeping since its introduction in 1967. Improvements in magnetic shielding, ruggedization and environmental performance permit improved performance and expansion of navigation and communication systems that have been made practical by the 5061A.

The design concept of the high performance beam tube includes unique HP designed dual beam optics with higher beam intensity to accomplish better short term stability and greater immunity to effects of shock and vibration. A 50 percent increase in resonance cavity length without change in the overall beam tube size contributes to better accuracy and settability because of the high Q of the narrower resonant line width. This tube retains the unique cesium standard feature of virtually no long term instability or aging.

The intrinsic accuracy is improved to $\pm 7 \times 10^{-12}$ which provides an excellent reference standard without need of calibration. If desired, as in many timekeeping applications, two or more units may be calibrated to determine the difference in rate or may be adjusted to the same frequency. With the improved settability specifications of 1×10^{-13} small changes in frequency are accomplished rapidly and accurately. A provision for degaussing the tube without adversely affecting the instrument operation allows removal of any residual magnetic field in the tube. This is important in achieving the settability performance.

The short term stability specification is improved by a factor of ten with this tube. The 5×10^{-12} (1 s avg.) performance compares very favorably with that of rubidium type standards which are noted for their excellent short term stability. An important advantage from the better short term stability is the capability to make measurements to 1 sigma precision of 1×10^{-12} in about one minute compared to the two hours required previously. The 5061A with the Option 004 High Performance Tube has the same high reliability as the 5061A with the standard tube. The new high performance tube is warranted for one year, but is designed to have the same long life as the standard tube.

10638A Degausser

The Model 10638A Degausser is designed for use with the Option 004 High Performance Beam Tube to achieve settability of $\pm 1 \times 10^{-13}$ and reproducibility of $\pm 3 \times 10^{-12}$. The degausser removes residual magnetic fields in the beam tube which slowly decay and cause a small frequency change. The degausser should be used when initially setting up the 5061A with Option 004 or after the instrument has been moved or adjusted.

K34-59991A Broadband Linear Phase Comparator

The K34-59991A accurately compares the phase relationship of the output signals of two frequency standards having the same nominal frequency between 100kHz and 10MHz. The comparator output signal is suitable for driving a stripchart recorder, thus allowing long-term monitoring of the frequency standards' output differences. By using this comparator, very small frequency differences can be detected and adjustments can be made to the frequency standards to correct for timekeeping errors.

E21-5061A Flying Clock

The E21-5061A consists of a 5061A Cesium Beam Standard with Option 001 LED Clock and K02-5060A Power Supply joined together to make one portable unit. The power supply, which can be operated from 6 or 12 V dc, 24 to 30 V dc, or 115/230 V $\pm 10\%$, 50 to 400 Hz, will provide approximately 7 hours standby power (from sealed nickel-cadmium batteries) for the 5061A Cesium Beam Standard.

This wide range of operating power capabilities enable the E21-5061A to operate on local power in virtually any country in the world. Operation is approved aboard commercial aircraft. The seven hours standby capability make it possible to travel where there is no power available and, of course, allow the E21-5061A to conveniently be transported between power sources and operated in almost any air or surface vehicle as a "flying clock" (see Hewlett-Packard Journal, August 1966 and December 1967).

The Option 004 tube, because of the improved shielding, offers a significant increase in accuracy under the varying earth's magnetic field conditions experienced by flying clocks and is a desirable addition to the E21-5061A. In addition, the better short term stability permits more accurate and rapid comparison of standards. The Option 002 Battery may also be added to increase standby capability.

FREQUENCY & TIME STANDARDS

Atomic Frequency Standards

Models 5061A, 5065A (Cont.)

- Compact, high reliability, proven performance
- Long term drift rate $< 1 \times 10^{-11}/\text{mo}$
- Time domain stability $< 5 \times 10^{-13}$ (100 s avg)

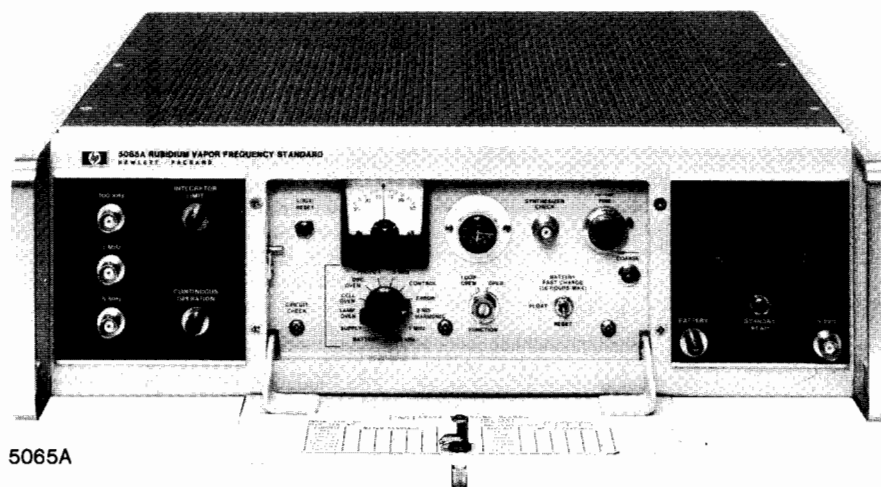

5065A Rubidium Frequency Standard

The HP Model 5065A is an atomic-type secondary frequency standard which uses a rubidium vapor resonance cell as the stabilizing element. As a result, it has long-term stability of better than 1×10^{-11} per month which exceeds that of high quality quartz oscillator frequency standards by 50 to 100 times. Furthermore, it has excellent short-term stability. These features contribute to its desirability as a coherent signal source, as a master oscillator for radio and radar systems where special requirements for stability and/or narrow bandwidth must be met, as a precision time keeper where the better performance of a cesium beam primary standard is not required, and as a house frequency standard for improved accuracy with fewer NBS calibrations compared to that required with quartz standards.

Front panel controls and circuit check meter of the 5065A are protected by a panel door. The magnetic field control provides fine frequency adjustment with which the frequency can be set to a precision of better than 2×10^{-12} without reference to a chart. The 5 MHz low noise quartz oscillator is phase-locked to the atomic frequency and provides the standard 5 MHz, 1 MHz, and 100 kHz outputs. The circuit check meter with selector switch monitors key voltages and currents for routine maintenance readings, calibration procedures, and fault finding.

The 5065A is designed for assured operation—to give the user confidence that the standard output signals are correct and locked to the atomic frequency. Logic within the unit maintains power to a “continuous” operation light on the front panel. If operation is interrupted, even momentarily, for any reason the light goes out and stays out until manually reset. An integrator limit light warns when the frequency correcting servo loop is approaching the limit of its dynamic range.

The HP Model 5065A is contained in a small-size package and is lightweight in comparison to a cesium beam standard. Additionally the rubidium resonance cell is much more frequency stable than quartz oscillators while subjected to shock and vibration, EMC, humidity, and magnetic field effects.

Reliability and warranty: the most significant module in the HP 5065A in terms of performance is the Rubidium Vapor Frequency Reference (RVFR). This temperature controlled, magnetically shielded unit includes the Rb gas cell and a photo sensitive detector

designed for maximum possible reliability. Field experience, including several million hours of operation, have demonstrated this reliability and the module is now warranted for a period of three years. This increased warranty protects the owner in the event of random failure.

The Option 001 Digital Clock has an easy to read LED time-of-day display. The olive black upper panel provides a dark background around the readout for excellent contrast and readability. Initial clock setting is accomplished by means of pushbuttons easily accessible by removing the top cover. The LED display offers high reliability, freedom from errors due to mechanical shock, and performance over the full environmental range of the 5065A. A sync button on the digital divider permits automatic synchronization of this 1 PPS pulse to an external pulse. The clock 1 PPS is adjustable in decade steps from $1 \mu\text{s}$ to 1 s, with respect to the synchronized reference, with 6 thumbwheel switches. A screwdriver adjustment allows fine continuous adjustment over a range of $1 \mu\text{s}$.

To conserve battery power, the display is not illuminated when ac power is not available. A STANDBY READ pushbutton below the display is used for readout when operating on the internal battery or external dc.

The Option 002 Standby Battery provides the 5065A with a minimum of 10 minutes standby power at 25°C . Switchover from line to battery is automatic so there is no interruption of operation if ac power should fail. A front panel ac interruption light warns when ac power has failed or has been disconnected. Fast or float charging rates may be selected when ac power is available.

The Option 003 combines the Option 001 Clock and Option 002 Battery and should be specified if both Options 001 and 002 are required.

E21-5065A Portable Time Standard

E21-5065A Portable Time Standard is a complete system for precision timekeeping and for transporting time from one location to another. It consists of the 5065A Rubidium Standard with digital clock and divider (Option 001) and the K02-5060A Power Supply with 6 or more hours standby capability. The component units are held together by side bars, and the interconnecting cables are protected by a back cover.



Specifications

Instrument:	5061A Option 004	5061A	5065A
Type of Standard:	Cesium	Cesium	Rubidium
Accuracy: maintained in magnetic field to 2 gauss and over temperature range of:	$\pm 7 \times 10^{-12}$ 0 to 50°C	$\pm 1 \times 10^{-11}$ 0 to 50°C	
Stability: Long Term: Short Term 5 MHz ⁽²⁾ : Averaging time: 0.01 1 10 100	$\pm 3 \times 10^{-12(1)}$ 1.5×10^{-10} 5×10^{-12} 2.7×10^{-12} 8.5×10^{-13}	$\pm 5 \times 10^{-12(1)}$ 1.5×10^{-10} 5.6×10^{-11} 2.5×10^{-11} 8×10^{-12}	$\pm 1 \times 10^{-11}$ /month 1.5×10^{-10} 5×10^{-12} 1.6×10^{-12} 5×10^{-13}
SSB Phase Noise Signal (1 Hz BW) Offset from signal: Hz: 10 ⁻³ 10 ⁻² 10 ⁻¹ 0 10 ¹ 10 ² 10 ³	-28 dB -48 dB -68 dB -96 dB -120 dB -125 dB -140 dB	-8 dB -28 dB -48 dB -82 dB -120 dB -125 dB -140 dB	-25 dB -52 dB -72 dB -93 dB -120 dB -126 dB -140 dB
Reproducibility ⁽⁴⁾	$\pm 3 \times 10^{-12(3)}$	$\pm 5 \times 10^{-12}$	
Settability (frequency) ⁽⁵⁾ :	$\pm 1 \times 10^{-13(3)}$	$\pm 7 \times 10^{-13}$	$\pm 2 \times 10^{-12}$
Warm-up:	At 25°C 30 Min.	At 25°C 45 Min.	At 25°C 1×10^{-10} 1 hr. 5×10^{-11} 4 hrs.
Sinusoidal Outputs: Output Voltage	5 MHz, 1 MHz, 100 kHz, Front & Rear BNC 1 V into 50 ohms		
Harmonic Distortion: (below rated output) Non-Harmonic related output: (below rated output) Under vibration or AC Mag Field: Signal-to-Phase Noise Ratio in 30 kHz noise BW (1 and 5 MHz):	>40 dB >80 dB >60 dB >87 dB	>40 dB >80 dB >60 dB >87 dB	>40 dB >80 dB >60 dB >87 dB
Environmental DC Magnetic Field Stability: AC Magnetic Field: 50, 60 and 400 Hz $\pm 10\%$ Temperature, operating with Option 001 or 002 Freq. change from 25°C:	$< \pm 2 \times 10^{-13}$ 2 Gauss Field $< 2 \times 10^{-12}$ for 2 Gauss peak 0 to 50°C $< 5 \times 10^{-12}$	$< \pm 2 \times 10^{-12}$ 2 Gauss Field $< 2 \times 10^{-12}$ for 2 Gauss peak 0 to 50°C $< 5 \times 10^{-12}$	$< \pm 5 \times 10^{-12}$ 1 Gauss Field $< 5 \times 10^{-12}$ for 1 Gauss peak 0 to 50°C $< 4 \times 10^{-11}$
Temperature, non-operating without options: with Option 001: with Option 002	-40°C to 75°C -40°C to 75°C -40°C to 50°C	-40°C to 75°C -40°C to 75°C -40°C to 50°C	-40°C to 75°C -40°C to 75°C -40°C to 50°C
Humidity, operating: 95% up to	40°C	40°C	40°C
Altitude, operating: Max. frequency change:	12.2 km (40,000 ft.) 2×10^{-12}	12.2 km (40,000 ft.) 2×10^{-12}	12.2 km (40,000 ft.) 2×10^{-11}
NOTES: (1) For life of beam tube. (2) Short-term stability for the 5061A with both standard and high performance tubes is given for the normal loop time constant. For improved short-term stability in controlled environments the long time constant may be used. (3) With 10638 Degausser. (4) Degree to which an oscillator will produce the same frequency from one occasion to another without recalibration. (5) Degree to which frequency can be set to agree with a reference frequency.			

FREQUENCY & TIME STANDARDS

Atomic Frequency Standards

Models 5061A, 5065A (Cont.)

Instrument	5061A Opt 004	5061A	5065A
Vibration: with isolators:	MIL-STD-167-1 MIL-T-21200	MIL-STD-167-1 MIL-T-21200	MIL-STD-167-1
Shock:	MIL-E-5400, Class 1 (30G)		
	1-MIL-T-21200, C.1		MIL-T-21200, C.1
EMC:	MIL-STD-461, Notice 3, Class A		
General			
Power: AC:	50, 60 or 400 Hz \pm 10%, 115/230 V \pm 10%		
DC:	43 W 22 to 30 V 27 W	43 W 22 to 30 V 27 W	49 W 23 to 30 V 35 W
Option 001: add (AC/DC)	10/7.5 W	10/7.5 W	10/7.5 W
Option 002: add (AC/DC)	22/4.5 W	22/4.5 W	6/0 W
Option 010: add (AC/DC)			
Dimensions (H x W x D): mm: inches:	221 x 425 x 416 8.7 x 16.7 x 16.4	221 x 425 x 416 8.7 x 16.7 x 16.4	133 x 425 x 416 5.2 x 16.7 x 16.4
Weight: (lb/kg)	70/31.8	67/30.5	34/15.4
Option 001: add (lb/kg)	2/0.9	2/0.9	2/0.9
Option 002: add (lb/kg)	5/2.3	5/2.3	3.5/1.6
Option 001, Clock			
1 PPS Outputs: Master: Clock:	Front & Rear BNC	Front & Rear BNC	Front & Rear BNC
Amplitude:	10 V peak into 50 Ω load		
Width:	20 μ s min	20 μ s min	20 μ s min
Rise Time:	<50 ns	<50 ns	<50 ns
Fall Time:	<2 μ s	<2 μ s	<2 μ s
Jitter, pulse-to-pulse:	<5 ns, rms	<5 ns, rms	<5 ns, rms
Synchronization:	Automatic, 10 \pm 1 μ s delay	Automatic, 10 \pm 1 μ s delay	Auto., 10 \pm 1 μ s delay
Clock pulse adjustment range:	1 μ s to 1 s	1 μ s to 1 s	1 μ s to 1 s
Clock display:	Solid State Digital		
Option 002, Standby Power Supply Capacity at 25°C with Option 001 Clock:	30 Minutes	30 Minutes	10 Minutes
Recharge, Fast/Float:	Automatic, fast charge		Switch

Ordering Information

5061A Cesium Beam Frequency Standard	\$29,300
Opt 001: Clock	add \$2,950
Opt 002: Standby Power Supply	add \$1,400
Opt 003: Clock and Standby Power Supply	add \$4,350
Opt 004: High Performance Beam Tube	add \$5,100
Opt 908: Rack Flange Kit	add \$27
E21-5061A Flying Clock	Add \$5,525

Consists of: 5061A with Opt 001 (not included in E21 price) and K02-5060A Standby Power Supply.

Weight: 64 kg (141 lb).

Size: 425 H x 405 W x 546 mm D (16.7" x 15.9" x 21.5") (includes handles).

Price

10638A Degausser

\$1,250

Weight: 1.2 kg (3 lb).

Size: 130 H x 77 W x 279 mm D (5.1" x 3" x 11").

5065A Rubidium Frequency Standard

\$16,900

Opt 001: Clock

add \$2,950

Opt 002: Standby Power Supply

add \$700

Opt 003: Clock and Standby Power Supply

add \$3,650

Opt 908: Rack Flange Kit

add \$22

E21-5065A Portable Time Standard

add \$5,125

Consists of: 5065A with Opt 001 (not included in E21 price) and K02-5060A Standby Power Supply.

Weight: 50 kg (110 lb).

Size: 425 H x 405 W x 546 mm D (16.7" x 15.9" x 21.5") (includes handles).

- Versatile with 3 input and 12 output channels
- Low noise, high stability, and isolation

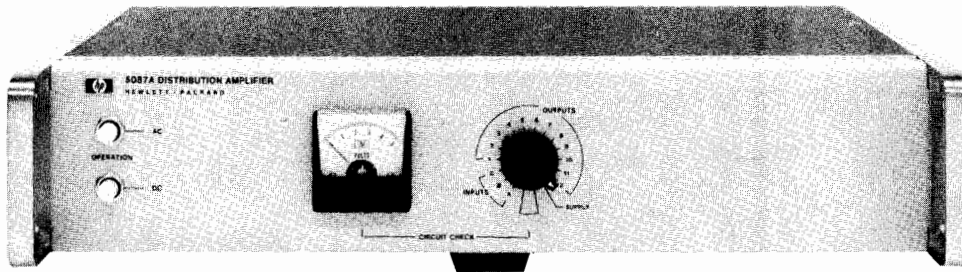

The Hewlett-Packard Model 5087A Distribution Amplifier provides the isolation and flexibility required for distribution of the output of high quality frequency standards. Low distortion and excellent isolation make it ideal for providing multiple outputs from atomic or crystal frequency standards. The 3 input channels will accept 10 MHz, 5 MHz, 1 MHz or 100 kHz in any combination. The number of outputs for each channel is selectable up to a total of 12 outputs. The output levels are individually adjustable from 0 to 3 V rms. All input and output levels are monitored on a front panel meter.

The Distribution Amplifier features plug-in modular construction, short circuit isolation, exceptional phase stability, low noise and cross-talk, and uninterrupted switchover to standby dc in event of ac power failure.

The shielding around each input and output plug-in amplifier assures minimum noise and crosstalk. The tuned output amplifiers provide clean signals and high channel-to-channel isolation.

The instrument is designed for maximum versatility and can be supplied to meet a wide variety of special requirements. The standard configuration of input and output amplifiers is shown in Figure 1.

Several other commonly used configurations are also available and special combinations of the various input and output modules can be supplied. Input and output amplifiers can be added or the configuration easily changed at any time.

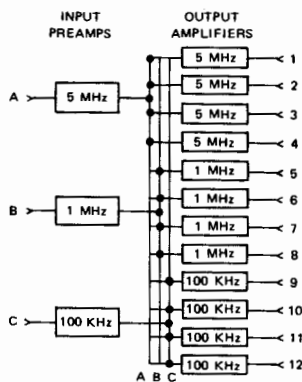

Figure 1. 5087A Distribution Amplifier with Option 031, Standard Configuration input and output amplifiers.

Specifications

Inputs: (up to three, rear panel BNC).

Frequencies: 10 MHz, 5 MHz, 1 MHz or 100 kHz.

Level: 0.3 to 3.0 V rms, 50 ohms.

Outputs: (up to 12 rear panel BNC).

Frequencies: 10 MHz, 5 MHz, 1 MHz or 100 kHz.

Level: 0–3 V into 50 ohms (screwdriver adjustment).

Harmonic distortion: >40 dB below rated output.

Non-harmonic distortion: >80 dB below rated output

Isolation

Load (open or short on any other channel)

Amplitude change: 0.1 percent.

Phase change: <0.1 ns at 5 or 10 MHz.

<0.5 ns at 1 MHz.

<5.0 ns at 100 kHz.

Injected signal: 1 V signal up to 50 MHz applied to any output except 10 MHz, will be down more than 60 dB in all other outputs; 10 MHz output channel will be down more than 50 dB.

SSB phase noise (5 MHz): >145 dB below signal in 1 Hz BW for frequencies > 1 kHz from carrier.

Short term stability degradation (5 MHz): < 1 x 10⁻¹² in 10 kHz band. (1 s average).

Environmental

Temperature: MIL-E-16400, Class 4.

Operating: 0–50°C; storage: –62° to +75°C.

Stability:

Amplitude: ±0.5 dB, 0° to 50°C.

Phase: <0.1 ns/°C., 5 and 10 MHz.

EMC: MIL-STD-461A.

Humidity: 95% at 40°C.

Vibration: MIL-STD-167.

Altitude: up to 30,000 ft.

Shock: MIL-T-21200, Class 1 and MIL-E-5400 (30 Gs).

General

Power: 115 or 230 V ±10%, 48 to 440 Hz, 20 VA, max, or 22–30 V dc, 500 milliamperes, max.

Dimensions: 88 H x 425 W x 286 mm D (3.5" x 16.7" x 11.3").

Weight: typical, Opt 031–Net 7 kg (15 lb).

Options

Normal configurations (input and output amplifiers)

031: 5, 1 and 0.1 MHz inputs and 4 outputs at each frequency add \$1525

032: Single 5 MHz input and 12 outputs add \$1425

033: Single 10 MHz input and 12 outputs add \$1425

034: Single 5 MHz input, 4 each outputs at 5, 1 and 0.1 MHz add \$1650

Special Configurations

Input preamplifiers (up to 3 total)

004: Input Preamplifier (0.1 to 10 MHz) add \$55

005: 5 to 1 MHz Input Divider add \$120

006: 1 to 0.1 MHz Input Divider add \$120

011: 5 to 10 MHz Input Doubler add \$120

013: 10 to 5 MHz Input Divider add \$120

014: 10 to 1 MHz Input Divider add \$120

Output amplifiers (up to 12 total)

001: 5 MHz Output Amplifier add \$120

002: 1 MHz Output Amplifier add \$120

003: 0.1 MHz Output Amplifier add \$120

012: 10 MHz Output Amplifier add \$120

908: Rack Flange Kit add \$25

5087A: Distribution Amplifier Mainframe

\$1400



FREQUENCY & TIME STANDARDS

Standby Power Supplies

Models 5085A & K02-5060A

- 12 Amp-hr capacity
- Sealed nickel-cadmium cells
- Used in "flying clocks"

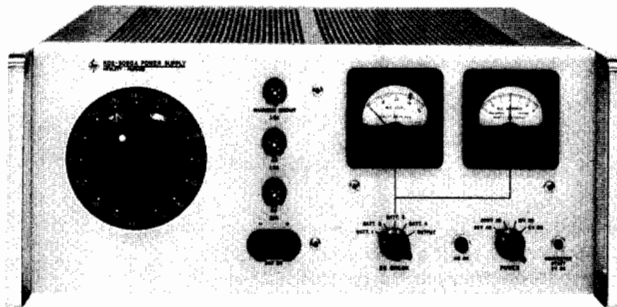

K02-5060A

The HP Models 5085A and K02-5060A Standby Power Supplies furnish dc power to keep frequency or time standard systems operating during extended interruptions of ac line power. For applications where it is essential to maintain continuous operation and avoid loss of precise time, the use of a standby power supply is an absolute necessity. These units are designed for use with the Hewlett-Packard Cesium Beam Standards, Rubidium Vapor Standards, Quartz Oscillators and other equipment which will operate from 22 to 30 V dc. No switching is used in transferring power from line to battery operation and back again thus assuring uninterrupted operation.

HP K02-5060A

The K02-5060A is a very versatile unit which was designed specifically as a portable power supply for the 5061A and 5065A "Flying Clocks" where it is necessary to operate from a wide range of power sources along with the standby capability to maintain continuous operation where no external power is available. A special inverter permits operation from a 6 or 12 V dc car battery in addition to the 115/230 V ac and 24-30 V dc capability. The 12 ampere-hour standby batteries are the sealed, nickel-cadmium type and thus spill-proof. Mounting hardware is available to attach the K02-5060A to either the 5061A or 5065A Standards to make a portable standard, the E21-5061A or E21-5065A.

HP5085A

The HP 5085A is intended for installation where 115 or 230 V ac is available. Vented nickel-cadmium batteries with an 18 ampere-hour guaranteed capacity (derated from 25) are used. They provide about 10 hours of standby power for the 5061A Cesium Standard or 5065A Rubidium Standard (at average ambient temperature of 25°C).

Front panel lights indicate mode of operation, report fuse failure, and ac interrupt. A float-charge switch permits rapid recharge after an ac power failure.

K02-5060A Specifications

Input and Output Voltages

Input	Output
6 or 12 V dc	0-230 V, 60 Hz nominal
115 or 230 V ac, 50-400 Hz	0-230 V ac
24-30 V dc	24-30 V dc

Standby battery, 26 ± 4 V dc available at all times.

AC and both dc inputs may be connected simultaneously.

Output current: 0.5A ac, 2 A dc.

Standby capacity: 12 ampere-hour at 25°C, 7 hours standby when used in E21-5061A, 6 hours in E21-5065A.

- 18 Amp-hr capacity
- Vented nickel-cadmium cells

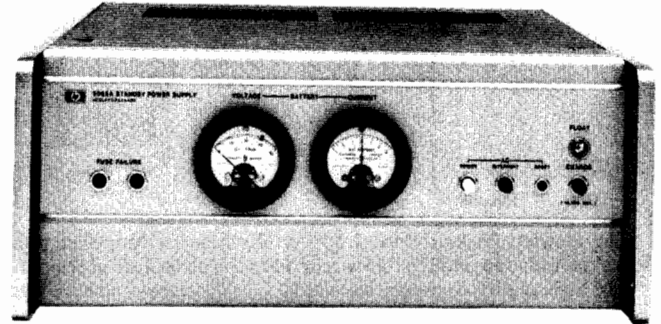

5085A

Recharging: 1.6 hours recharging time required for each ampere hour of discharge.

Alarm indicator: external power failure.

Panel meters: voltmeter, ammeter indicating voltage and current of 4 internal batteries and load.

Battery: four paralleled rechargeable battery packs each containing 20 sealed nickel-cadmium cells. Packs may be removed individually without interfering with power supply operation.

Temperature

Operating: 0 to 50°C.

Storage: -40 to 60°C

Size: 177 H × 425 W × 416 mm D (7" × 16.7" × 16.4").

Weight: net, 30.5 kg (67 lb).

5085A Specifications

Output voltage: 24 ± 2 V dc at rated current.

Output current: 2 amperes (2.5 A for 30 min.).

Standby capacity: (at 25°C) 18 amp-hrs. after 48 hours charge.

Alarm indicators: panel lamps indicate: (1) FUSE FAILURE, (2) AC POWER, (3) AC INTERRUPT, (4) CHARGE.

Remote alarm provisions: SPDT relay contacts provided at rear terminals for operating remote alarm from separate power system.

Panel meters: battery voltage and charge/discharge current.

Power requirements: 115 or 230 ± 10% V ac; 50 to 400 Hz (2.0 A max. at 115 V line).

Battery (supplied): vented nickel-cadmium 25 ampere-hour capacity derated to 18 ampere-hours. Periodic maintenance required.

Additional (external) battery provision: rear connector.

Temperature

Operating: 0 to 50°C.

Storage: -40 to 75°C.

Size: 177 H × 425 W × 416 mm D (7" × 16.7" × 16.4").

Weight: net, 34.1 kg (75 lb). Shipping, 45.9 kg (101 lb) including battery. Option 001 (no batteries) is 22.8 kg (50 lb) less.

Ordering Information

5085A(complete with batteries)

Opt 001: without batteries

Opt 908: Rack Flange Kit

K02-5060A

Opt 908: Rack Flange Kit

Price

\$5300

less \$640

\$22.50

\$4800

\$22.50



Introduction

The digital electronic frequency counter has come a long way since the first versions appeared three decades ago. Once the luxury of large metrology labs and some crystal manufacturers, the frequency counter is now common-place in laboratories, on production lines, as a service tool and in automatic instrumentation systems. Moreover, counters have become increasingly more versatile and more powerful in the measurements they perform, thereby finding much wider applications. When Hewlett-Packard introduced the 524A in 1952 it was considered a milestone; the counter could measure frequencies up to 10 MHz, or the time between two electrical events to a resolution of 100 ns. Thirty years later, HP's product lines feature counters that can measure the frequency of a 70 mV signal at 40 GHz completely automatically, or can measure time intervals to 20 ps, the same time it takes light to travel 6 mm.

Basic Counter Measurements

The basic measurements which counters are capable of performing are described in this section.

Frequency

This fundamental measurement is performed by totalizing the number of input cycles or events for a precisely known period of time. The total count that results is proportional to the unknown frequency, and logic circuits internal to the counter position the

decimal point such that the display directly indicates the input frequency. The time reference is usually derived from a precision quartz oscillator internal to the counter.

Using this basic technique allows measurements to 500 MHz to be made. Several methods are available, however, to extend this frequency range to 40 GHz and more. These are described in more detail below.

Period

This inverse of frequency capability is sometimes offered to provide the user with high resolution, low frequency measurements. In digital systems a period measurement represents the average bit to bit time of the input signal.

Totalize

The measurement is similar to frequency except that the user now controls the time over which the measurement takes place. With digital systems becoming more prevalent, this fundamental measurement assumes considerable importance. The HP 5345A, with its ability to totalize at a 500 megabit rate, represents the current state of the art.

Ratio

The ratio between two input frequencies is a measurement that is also offered by some counters. The major application for ratio is measurement of harmonically related signals.

Scaling

Some counters offer the capability of providing a digital output signal whose frequen-

cy is a scaled or divided version of the input frequency.

Time Interval

The measurement of the time between two events or the time between two points on a common event, commonly referred to as time interval, is of major importance and is used in a wide variety of applications.

The ± 20 ps single shot resolution of the 5370A represents today's state of the art. This unit utilizes a new concept of phase locked vernier interpolation which eliminates quantization errors. HP also pioneered the concept of time interval averaging, whereby for repetitive inputs substantial improvement in resolution over the single shot measurement can be obtained.

Time interval averaging is offered in seven HP counters (5370A, 5345A, 5335A, 5328A, 5316A, 5315A/B and 5308A). Also available for precision time interval measurements is the 5363B Time Interval Probes box usable with any time interval counter. The 5363B has a wide dynamic range as well as a built in calibration feature and digitally set trigger voltages to eliminate the major uncertainties associated with TI measurements. The 5363B is fully programmable via the HP Interface Bus for systems applications.

All manner of time interval measurements are discussed in detail in Application Note AN 200-3 "Precision Time Interval Measurements Using an Electronic Counter" available on request from any Hewlett-Packard sales office.

ELECTRONIC COUNTERS

General Information (cont.)

Application Note 200: Fundamentals of Electronic Counters

This forty-four page application note describes in detail the measurements mentioned above. In addition, the key considerations in making frequency and time measurements, plus the major characteristics required of a counter for certain applications are also described. For those readers who require more than the brief resumé above, this application note is available on request at any Hewlett-Packard sales office.

The contents of AN 200 are as follows:

- Introduction
- Fundamentals of Conventional Counters
 - Functions
 - Input Considerations
 - Time Base Oscillator Considerations
 - Main Gate Requirements
 - Sources of Measurement Error
- Reciprocal Counters
- Time Interval Measurement
 - Input Considerations
 - Trigger Level
 - Increasing Accuracy and Resolution
 - Use of Time Interval Probes
- Automatic Microwave Frequency Counters
 - Down-Conversion Techniques
 - Comparison of Performance of the Down-Conversion Techniques

The Major Types of Electronic Counters

While counters can potentially offer all the measurement capabilities described above, they essentially fall into three classes: frequency counters; universal counters; and microwave counters. These are described below.

Frequency Counters

These counters offer the basic capability of frequency measurement and in addition sometimes provide some or all of the other measurements described above except time interval. HP has a wide range of counters that fall into this class including: a) the 5380 low cost bench series, a family of three counters featuring 80 MHz—7 digit, 225 MHz—8 digit and 520 MHz—9 digit instruments; b) the 5300 portable, battery operated snap-on series with the 5303B snap-on covering 525 MHz and the 5305B 1300 MHz counter.

Table 1. Frequency Counters Summary

Model No.	Frequency Range	Number of Digits	Time Base	Other Functions*
5300/5301A	10 MHz	6	3×10^{-7}	T
5381A	80 MHz	7	3×10^{-7}	
5382A	225 MHz	8	3×10^{-7}	
5383A	520 MHz	9	3×10^{-7}	
5300/5303B	525 MHz	8	3×10^{-7}	
5300/5305B	1300 MHz	8	3×10^{-7}	
5340A	23000 MHz	8	3×10^{-7}	
5342A	24000 MHz	11	1×10^{-7}	A, Fo, Ao
5343A	26500 MHz	11	1×10^{-7}	Fo

*See legend next page

Table 2. Universal Counter Summary

Model No.	Frequency Range	Time Interval Resolution		Time Base	Other Functions*
		Single Shot	Averaging		
5300A/5304A	10 MHz	100 ns	—	3×10^{-7} per Month	MPA, T, R
5300/5302A	50 MHz	100 ns	—	3×10^{-7} per Month	P, MPA, T, R
5300A/5308A	75 MHz	100 ns	100 ps	3×10^{-7} per Month	P, MPA, T, R
5314A	100 MHz	100 ns	—	3×10^{-7} per Month	P, MPA, T, R
5316A/5315A/B	1100 MHz	100 ns	10 ps	3×10^{-7} per Month	P, MPA, T, R, E
5328A	1100 MHz	100 ns or 10 ns	10 ps	3×10^{-7} per Month	P, MPA, T, R, E, V**
5370A	100 MHz	± 20 ps	1 ps	3×10^{-7} per Month	P, MPA, E
5335A	1200 MHz	2 ns	100 ps	3×10^{-7} per Month	P, MPA, T, R, E, Fo, V**
5345A	500 MHz	2 ns	2 ps	5×10^{-10} per Day	P, MPA, T, R

*See legend next page

**Optional function

†Higher frequency optional

Universal Counters

These instruments provide time interval capability in addition to the other measurements provided by the frequency counter.

The 5314A is such an instrument featuring 100 MHz frequency, 100 ns time interval, plus period, ratio and totalize. The 5315A/B and 5316A provide all these functions plus time interval delay, time interval average and reciprocal frequency measurements. The 5300 family of snap-on modules starts with the frequency, period, time interval, ratio, and totalize capabilities of the 5302A. The 5304 adds time interval delay to this. Another member of the same family, the 5308A offers time interval averaging, totalizing (with electronic start and stop) and frequency to 75 MHz. The 5328A (100 MHz) and 5328A Opt 031 (1300 MHz) are high performance rack mount instruments programmable (Opt 011) via the HP Interface Bus. Time interval averaging gives resolution to 10 ps on repetitive signals and Opt 040 also has 10 ns one shot resolution. The 5335A expands upon the 5328A capabilities by adding 2 ns time interval resolution, 9 digits of frequency measurement/s., automatic triggering, reciprocal frequency, pulse width, rise and fall time, slew rate, duty cycle, phase, and inverse time interval measurements. Included are math capabilities such as offset, normalize, and scale, plus statistics. The 5345A offers a 500 MHz bandwidth, with totalizing, ratio and period capability to this speed (500 MHz), plus 2 ns single shot time interval and 2 ps time interval averaging. This extremely powerful instrument features plug-in flexibility and a reciprocal frequency measurement mode (see next page).

Finally, the 5370A offers the ultimate in time interval resolution with 20 ps single shot and 1 ps time interval averaging!

Microwave Counters

These instruments provide high accuracy frequency measurements into the microwave spectrum. The 5342A harmonic heterodyne microwave counter automatically measures frequencies to 24 GHz under microprocessor control, and features 1 Hz resolution and wideband FM tolerance. The keyboard controls allow the user to program his own frequency offsets. The amplitude option will simultaneously display input frequency and input level for readily monitoring microwave devices and equipment. The 5343A extends this automatic frequency measurement to 26.5 GHz and increases the sensitivity. The 5354A is a 4 GHz heterodyne converter that plugs into the 5345A mainframe and provides extremely high resolution automatic measurements for CW and pulsed RF down to pulse widths of 20 ns. The 5355A is an automatic frequency converter plug-in for the 5345A mainframe. Together with the 5356A 18 GHz converter head, 5356B 26.5 GHz converter head, or the 5356C 40 GHz converter head, this plug-in provides a complete microwave counter solution for pulsed RF or CW microwave applications. Microprocessor control and a front panel keyboard provide user selectable offsets, diagnostic routines, automatic calibration and other user conveniences for the first time.

The 5340A automatic transfer oscillator counter can measure frequencies from 10 Hz to 23 GHz via a single input at up to -35 dBm sensitivity.

Application note 200-1 covers the fundamentals of microwave frequency counters and compares the various techniques. Application Note 291-1 discusses the use of the 5355/56 in a number of pulsed and CW microwave frequency measurement applications.

Table 3. Microwave Counter Summary

Model No.	Frequency Range	Technique	Time Base	Sensitivity	Number of Digits
5354A*	4 GHz	Auto Heterodyne	5×10^{-10} per Day	-10 dBm	11
5355A*	40 GHz	Auto Harm Heterodyne	5×10^{-10} per Day	-20 dBm	11
5255A**	to 18 GHz	Manual Heterodyne	3×10^{-9} per Day	-13 dBm	8
5257A**	18 GHz	Manual Transfer Osc.	3×10^{-9} per Day	-7 dBm	8
5340A	23 GHz	Auto Transfer Osc.	3×10^{-7} per Month	-35 dBm	8
5342A	24 GHz	Auto Harm Heterodyne	1×10^{-7} per Month	-25 dBm	11
5343A	26.5 GHz	Auto Harm Heterodyne	1×10^{-7} per Month	-33 dBm	11

*Plug-in to 5345A Counter

**Plug-in to 5245 Series or 5345A Counter with adapter

Reciprocal Counting Technique

The extremely powerful reciprocal counting technique is employed in several counters available from Hewlett-Packard. The distinction between this and the conventional technique is that the latter provides 1 Hz resolution in one second, whereas the resolution of the reciprocal technique is proportional to the frequency of the internal counted clock. The five instruments available are summarized in Table 4 below. Note that the 5345A is a plug-in instrument and hence the high mainframe resolving power offered applies to any of the compatible plug-ins. It has pulsed RF measurement capability via an external gate mode. In addition the 5345A includes a unique frequency averaging mode that allows high resolution measurements on repetitive pulses even if pulse width is 50 nsecs. The 5370A extends the reciprocal technique by means of phase locked vernier interpolation to give the ultimate in resolution. Fre-

quency measurements to better than 10 digits may be made in 1 sec.

HP Interface Bus

The more recently introduced counters (and other HP digital instruments) have a digital input/output structure which is compatible with the interface bus which is Hewlett-Packard's implementation of the IEEE Digital Interface Standard 488-1975. HP Desktop Calculators in the 9825/30 Series and Minicomputers in the HP 2100/21MX Series are also compatible with the in-

terface bus, making it possible to expand the capabilities of the individual instruments even into areas of real time data reduction and control. Interfacing is available for interconnecting up to 14 compatible devices on one I/O slot. The HP 59310B Computer Interface serves for minicomputers and the HP 98034A or 59405A HP-IB Calculator Interface interconnects up to 14 devices using one I/O slot and one ROM. At this time, compatible instruments are the 5345A, 5370A, 5340A, 5342A, 5343A, 5335A, 5328A, 5316A, and 5312A (for 5300B system).

Table 4. Reciprocal Frequency Counters

Model No.	Frequency Range	Measurement Resolution	Number of Digits	Time Base	Sensitivity
5300A/5307A	2 MHz	3×10^{-5}	6	3×10^{-7} per Month	10 mV rms
5316A/5315A/B	100 MHz	1×10^{-7}	8	3×10^{-7} per Month	10 mV rms
5370A	100 MHz	1×10^{-10}	16	3×10^{-7} per Month	35 mV rms
5335A	200 MHz	2×10^{-5}	12	3×10^{-7} per Month	25 mV rms
5345A	500 MHz	2×10^{-5}	11	5×10^{-8} per Day	20 mV rms

Table 5. Counter Selection Guide

Classification	Description	Frequency	Functions*	Time Base	Price	Page
5381A, 5382A & 5383A Low Cost	Traditional HP quality and reliability at low prices.	To 520 MHz	F	3×10^{-6} /Mo. Optional 1×10^{-7} /Mo.	From \$425	347
5314A Low Cost Universal Portable	Traditional HP quality and reliability at low price	100 MHz	F, P, MPA, TI, T, R	3×10^{-7} /mo. Optional 1×10^{-7} /mo.	From \$475	341
5315A/B & 5316A Economic Reciprocal Portable	A high performance microprocessor controlled universal counter with sub nanosecond time interval averaging capability and optional high frequency coverage. 5315B offers rack/stack package and improved RFI.	To 1000 MHz	F, P, MPA, TI TI AVG, T, R, E	3×10^{-7} /mo. Optional 1×10^{-7} /mo.	From \$950	338
5300 Series Economic Portable	Select from 8 plug-ons to meet present needs. Move up in functions or frequency range when needed. Battery pack, D to A converter and HP Interface Bus output module extend versatility.	To 1300 MHz	F, P, MPA, TI TI AVG, T, R V, E	3×10^{-7} /Mo. Optional 1×10^{-7} /Mo.	From \$1000	342
5328A Universal Counter	A high performance universal counter with sub nanosecond time interval averaging capability that can include high frequency measurement, DVM or HP Interface Bus options.	To 1300 MHz	F, P, MPA, TI TI AVG, T, R, V, E	3×10^{-7} /Mo. Optional 1.5×10^{-8} /Mo.	From \$1725	334
5335A Universal Counter	A new high performance Universal counter with auto trigger, pulse characterization, phase measurements, math, statistics, and HP-IB standard. Programmable trigger levels, higher frequency & DVM optional.	To 1300 MHz	F, P, MPA, TI, TI AVG T, R, V, E, Fo	3×10^{-7} per Mo. Optional 1.5×10^{-8} per Mo.	From \$3350	331
5345 Series High Performance Plug-in Counters	A series of high performance mainframe and plug-ins, providing 500 MHz direct count, 2 nsec time interval, and up to 40 GHz automatic pulsed RF measurements.	To 40 GHz	F, P, MPA, TI, TI AVG, T, R E	1.5×10^{-8} /Mo. ($< 5 \times 10^{-9}$ /Day)	From \$6600	318
5340, 5342A, 5343A Automatic Counters	Broad band, high sensitivity, microwave frequency measurements 10 Hz-23 GHz, 10 Hz-24 GHz, 10 Hz-26.5 GHz.	To 26.5 GHz	F, Fo, A, Ao	Optional to 1.5×10^{-8} /Mo. ($< 5 \times 10^{-9}$ /Day)	From \$5500	324
5370A Universal Time Interval Counter	Highest resolution frequency measurements and time interval measurements to ± 20 ps resolution	100 MHz	F, P, MPA, TI, TI AVG	1.5×10^{-8} /mo.	\$8750	328

***Legend for Functions**

- | | | |
|-------------------------------|--------------------------------|--|
| F = Frequency | A = Amplitude | V = Voltage |
| P = Period | TI AVG = Time Interval Average | E = Electronically Controlled Totalize |
| MPA = Multiple Period Average | T = Totalize | Fo = Frequency Offsets |
| TI = Time Interval | R = Ratio | Ao = Amplitude Offsets |

318 **ELECTRONIC COUNTERS**
500 MHz Plug-In Counter
Model 5345A

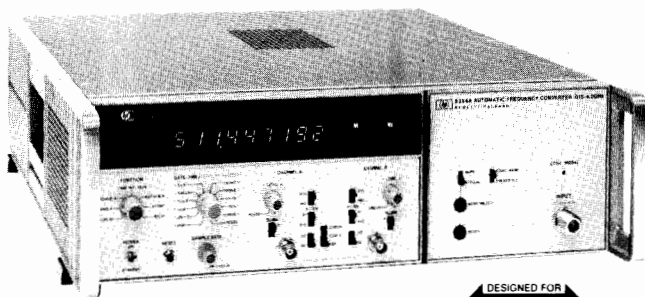

The 5345A Electronic Counter represents the most advanced general purpose instrument in the Hewlett-Packard Counter Product line. Utilizing state of the art monolithic bipolar integrated circuit technology especially designed and manufactured at Hewlett-Packard, this instrument provides unsurpassed power, versatility and flexibility in frequency and time measurements.

Major Mainframe Features

Frequency: direct from DC to 500 MHz—Reciprocal technique provides high measurement resolution.

Time interval: resolution of 2 ns single shot.

Averaging: new modulated clock technique gives true averages under all conditions. T.I. resolution extended to 2 ps. Frequency averaging improves RF pulse measurements similarly.

Totalize: to 500 megabit rate on both A and B inputs. A ± B functions also available.

Ratio: from DC to 500 MHz on both inputs.

Fully programmable: provides great flexibility when used with calculators and computers.

Plug-in versatility: three plug-ins presently available. In addition the 10590A plug-in adapter allows most existing 5245 plug-ins to be used.

Signal Input Circuits

Signal conditioning: fully optimized front end includes switchable

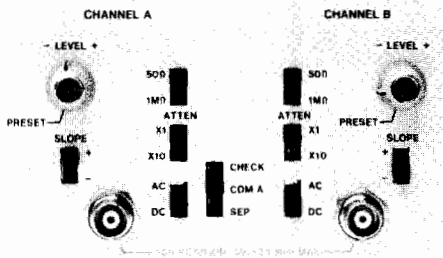

Figure 1. Input Switches

50Ω/1 MΩ input impedances, DC/AC coupling, and slope selection that assures triggering on any waveform.

Sensitivity, dynamic range: highly sensitive wideband amplifiers

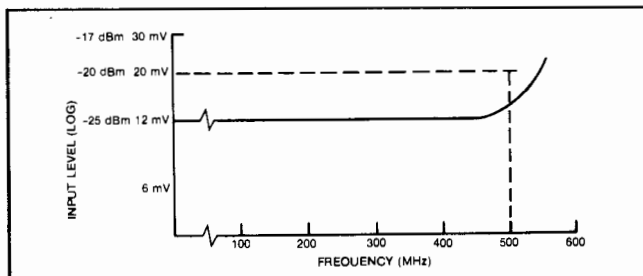

Figure 2. Typical Amplifier Sensitivity

- 500 MHz Direct Counting
- 20 mV Sensitivity DC to 500 MHz
- 2 ns Single Shot T.I. Resolution
- Averaging to 2 ps resolution
- Pulsed RF and Microwave Measurements
- Programmable for systems applications via HP-IB

assure measurements on even the lowest level sinusoidal and digital signals. The inputs also feature an extremely wide linear dynamic range of -2 to +5 V DC that greatly increases measurement versatility, especially on digital input signals.

Frequency Measurements

Reciprocal capability: one of the advantages of measuring period

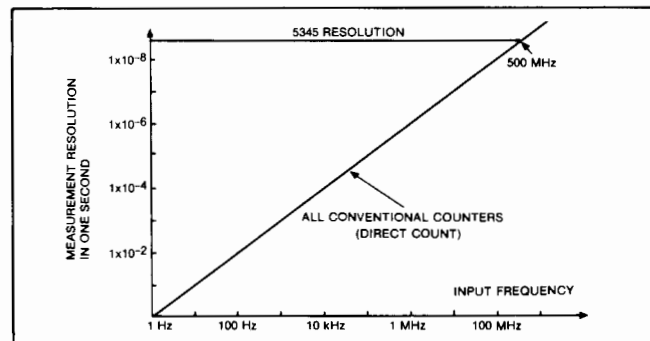

Figure 3. Measurement Resolution

and computing the frequency is that measurement resolution is independent of input frequency and at the maximum to which the instrument is capable of resolving. Thus for example, a 1 MHz input can be resolved to 2×10^{-9} (=0.002 Hz) in one second, whereas the conventional counter provides 1 Hz resolution, some 500 times less.

Measurement Speed

Mode of Operation	Readings per Second
Normal Operation (Max sample rate)	10
Externally armed	500
Externally gated	500
Computer dump	9,000

The extremely high resolution obtained in one second can be traded for measurement speed. For example of 100 μs gate time provides a resolution of 2×10^{-5} yet the measurement can now be made 5000 times a second, thus making the 5345A an invaluable tool in high speed data acquisition systems.

Ext. gated capability: via the rear panel gate control input; this capability allows the operator to determine at what point in real time and for how long the measurement is to be made. This capability essentially replaces the front panel "sample rate" and "gate time" controls.

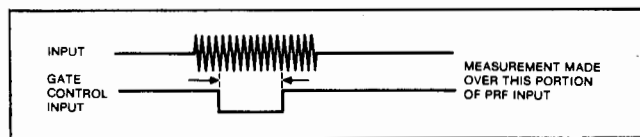

Figure 4. External Gate Control

The major application is in the measurement of pulsed RF signals. **Frequency averaging:** the minimum pulse width for which the input frequency can be measured is 20 ns. The single shot measurement resolution is 2×10^{-9} divided by the GATE TIME. This resolution can be improved up to 1000 times by a unique mode of operation known as frequency averaging that is built into the mainframe. The only requirement for this mode is that the signal is repetitive.

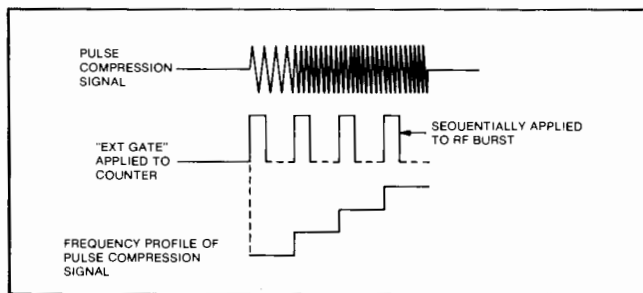

Figure 5. Frequency Averaging to Increase Resolution

In addition to greatly enhancing narrow pulse measurement capability, the frequency averaging mode also allows higher resolution on pulse profile measurements.

Time Interval

Precision measurement: the single shot time interval measurement resolution of the 5345A is 2 ns, which is the time it takes light to travel approximately 2 Ft—the 5345A is an extremely high resolving time measuring device.

Trigger level: quantitative high speed time interval measurements are provided by the 5345A since the user can simply determine where triggering occurs even on complex waveforms. The method of determination involves measuring the DC levels at which triggering occurs. These DC levels are available at rear panel BNC's.

The ability to determine trigger level, together with high sensitivity and wide dynamic range of the inputs greatly enhances the versatility and power of the 5345A in time interval measurements.

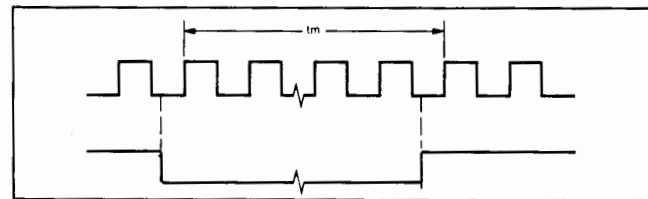

Figure 6. Using EXT GATE to Measure Tm

Ext. gate capability: external gating adds even more versatility to the time interval measurements of the 5345A, as measurements such as that shown in figure (6) indicate.

Time interval averaging: for repetitive inputs a successive number of measurements may be automatically averaged by the 5345A, obtaining up to 1000 times improvement in resolution (2 ps). This averaging mode may be used irrespective of whether the instrument is in the conventional or ext. gate mode of operation.

Totalize

High speed: the 5345A has the ability to totalize to a 500 megabit

rate through either or both A and B inputs. Coupled with the high sensitivity and full signal conditioning of both channels, this capability enables measurements to be made on most modern digital systems.

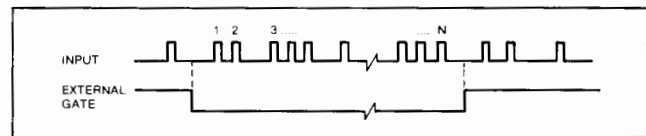

Figure 7. Selecting a Portion of a Pulse Train

Ext. gate capability: using the external gated mode allows the user to select only the desired portion of the input pulse train for measurement.

A ± B Modes

The A—B mode is used for comparison tests between high speed reference and test signals applied to the two mainframe inputs.

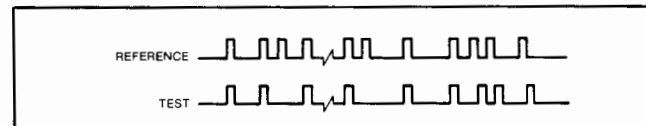

Figure 8. Comparison Measurements

Any difference between the total number of events accumulated in each channel is indicated by the 5345A display after the measurement is completed.

The primary application for the A + B mode is in the measurement of NRZ signals. By setting the "A" trigger slope to "+" and the B slope to "-" allows all transitions and hence bits of the NRZ signal to be counted. Thus 1 gigabit NRZ waveforms can be measured.

This mode of operation does not introduce any limitations—maximum input rate is 500 megabits on either channel and external gating may be used.

Ratio

This measurement represents the ratio of the number of events occurring through channel B divided by the number occurring through channel A. The major features are: a) that the measurement or comparison (similar to the A ± B totalize modes); and, b) the frequency or bit rate of either channel can vary from DC to 500 MHz. These features allow this measurement to be extremely useful in digital systems and synthesizer check out.

Digital I/O

Option 011 provides complete digital input-output capability (except slope and level control) to the 5345A. Digital output is a bit parallel, byte serial ASCII coded format and the I/O structure conforms to the Hewlett-Packard Interface Bus (HP-IB) standard. This option is particularly recommended for a bench top calculator controlled environment.

Option 012 is similar to Option 011, but includes programmable control of slope and level. Option 012 is recommended for a computer controlled environment.

The model 59310B Interface Kit provides a complete operational package for use with the HP 2100 Series Computers. Similarly, other interface kits allow the user to interface the 5345A Option 011 or 012 and other HP-IB compatible devices to the 9825 and 9830 Series HP Desktop Computers.



ELECTRONIC COUNTERS

5345A Condensed Specifications

Frequency/Period Measurements

Range: 0.00005 Hz to 500 MHz.

Accuracy: $\pm \frac{2 \times 10^{-9}}{\text{gate time}} \pm \text{trigger error}^* \pm \text{time base error}$.

Gate time: 1000 seconds to 100 nanoseconds in decade steps; <50 ns in MIN position.

Time Interval/Time Interval Average

Range: 10 nsec to 20,000 sec.

Minimum dead time: 10 nsec.

Trigger pulse width: 1 nsec minimum width input at minimum voltage input.

Accuracy:

Time interval: $\pm \text{trigger error}^* \pm 2 \text{ ns} \pm \text{time base error}$.

Time interval averaging:

$$\pm \frac{\text{trigger error}^* \pm 2 \text{ nsec}}{\sqrt{\text{intervals averaged}}} \pm 0.7 \text{ nsec} \pm \text{time base accuracy}$$

Not affected by harmonics of clock frequency.

Resolution:

Time interval: 2 nsec.

Time interval average:

$$\pm \frac{2 \text{ nsec}}{\sqrt{\text{intervals averaged}}} \pm 2 \text{ picoseconds.}$$

Ratio B/A

Range: both channels accept dc to 500 MHz.

Accuracy: $\pm \text{L.S.D.} \pm \text{trigger error}^*$.

Start/Stop

Range: both inputs dc to 500 MHz.

Modes: A, A \pm B determined by rear panel switch.

Scaling

Range: dc to 500 MHz.

Scaling factor: selectable by GATE TIME setting. Scaling factor equals GATE TIME setting/10⁻⁹ seconds.

Input: input signal through channel A.

Output: output frequency equals input frequency divided by scaling factor. Rear panel BNC supplies 80% duty cycle TTL compatible pulses.

Input Channels A and B

Range: 0 to 500 MHz dc coupled 50 Ω and 1 M Ω ; 4 MHz to 500 MHz ac coupled, 50 Ω ; 200 Hz to 500 MHz ac coupled, 1 M Ω .

Impedance: selectable, 1 M Ω shunted by less than 30 pF or 50 Ω (nominal).

Sensitivity: X1, 20 mV rms sine wave and 60 mV peak-to-peak pulse. X10, 250 mV rms sine wave and 750 mV peak-to-peak pulse.

Dynamic range: 50 Ω & 1 M Ω : 20 mV to 250 mV rms sine wave (X1); 250 mV to 2.0 V rms (X10).

Trigger level: adjustable over ± 1.3 V dc.

Output: rear panel BNC connectors bring out CHAN A TRIG LEVEL and CHAN B TRIG LEVEL for convenient DVM monitoring. Accurate to ± 15 mV.

Common Input

In this mode the signal is applied to channel A.

Range: ac coupled 50 Ω , 4 MHz to 400 MHz; ac coupled 1 M Ω , 300 Hz to 400 MHz.

Impedance: 50 Ω remains 50 Ω ; 1 M Ω becomes 500 k Ω shunted by <60 pF.

Sensitivity: 50 Ω : 40 mV rms; 1 M Ω : No change.

Dynamic range: 50 Ω : 40 mV to 500 mV rms (X1); 500 mV to 4 V rms (X10); 1 M Ω : No change.

$$* \text{trigger error} = \frac{1.4 \sqrt{(150 \mu\text{V})^2 + e_n^2}}{\text{Input Voltage slew rate at trigger point (V/S)}} \text{ seconds rms}$$

where 150 μ V is the TYPICAL rms input amplifier noise on the 5345A and e_n is the rms noise of the input signal for a 500 MHz bandwidth.

General

Display: 11 digit LED display and sign. Annunciator displays ksec to nsec, k to n, μ Hz to GHz. Decimal point is positioned with DISPLAY POSITION control or positioned after the first, second or third most significant digit if DISPLAY POSITION is in AUTO. Leading zeros are suppressed.

Overflow: asterisk is illuminated when display is overflowed.

Sample rate: continuously variable from <0.1 sec to >5 sec with front panel control. In HOLD position the last reading is maintained until the counter is reset.

External arm input: counter can be armed by a -1.0 V signal applied to the rear panel 50 Ω input.

External gate input: same conditions as for EXT ARM.

Gate output: >1 volt into 50 Ω .

Time Base

Standard high stability time base: crystal frequency, 10 MHz (10544A).

Stability

Aging rate: <5 x 10⁻¹⁰ per day.

Short term: <1 x 10⁻¹¹ for 1 sec average.

Temperature: <7 x 10⁻⁹, 0°C to 55°C.

Opt 001: crystal frequency, 10 MHz.

Stability:

Aging rate: <3 x 10⁻⁷ per month.

Short term: <2 x 10⁻⁹ rms for 1 sec.

Temperature: <2 x 10⁻⁸, 25°C to 55°C.

<5 x 10⁻⁸, 0°C to 55°C.

Line voltage: <1 x 10⁻⁸, $\pm 10\%$ from nominal.

Self test: a 100 MHz signal is internally applied.

External frequency standard input: input voltage >1.0 V rms into 1 k Ω required from source of 1, 2, 2.5, 5 or 10 MHz ± 5 x 10⁻⁸ (± 5 x 10⁻⁶ for opt. 001). Input can be sine or square wave.

Frequency standard output: >1 V rms into 50 Ω at 10.0 MHz sine wave.

Operating temperature: 0°C to 55°C.

Power requirements: 100/120/220/240 V rms +5% -10% 48 to 66 Hz, maximum power 250 VA.

Weight: 17 kg (37 lb).

Size: 132.6 H x 425 W x 495 mmD (5.22" x 16.75" x 19.5").

Options and Accessories

	Price
001: Room Temperature Time Base	less \$350
010: Digital output only. HP Interface Bus format, talk only.	add \$350
011: Digital Input/Output same as Opt 010, Compatible with HP Interface Bus and allows 5345A to be remotely programmed. (Does not include cable)	add \$925
012: Digital I/O similar to Opt 011. Includes slope and level control. (Does not include cable. See page 28)	\$1600
908: Rack flange kit, number 5061-0077	add \$25
K13-59992A: includes state machine tester as an aid for trouble-shooting the arithmetic processor	
10595A Board extender kit: useful for troubleshooting plug-in boards while in operation	\$725
10590A Plug-in adapter: adapts 5245 series plug-ins to 5345 (see next page)	\$1200
K15-59992A Standby power unit: plug-in to maintain oscillator operation for prolonged periods without line voltage	

Available Reference Material

5345A Data Sheet

AN-173-1 Dynamic Measurement of Microwave VCO's

AN-174 Applications Series on Counter/Calculator Instrument Groupings

AN-200-3 Precision Time Interval Measurements

HP Journal June 1974

I.D. #90337D Color Video Tape Applications and Demonstrations

5345A Plug-In Counter

\$6600

- Fully automatic to 4 GHz
- Pulse Measurements
- Frequency averaging
- Count a group of events between A and B
- Frequency sum and difference measurements

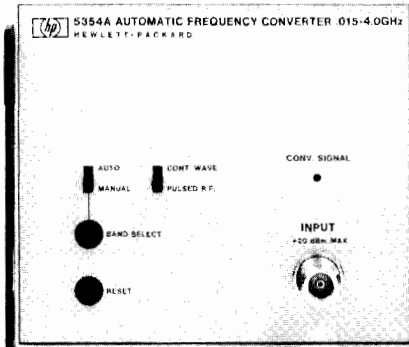

5354A

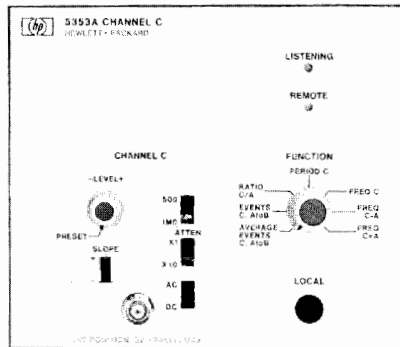

5353A

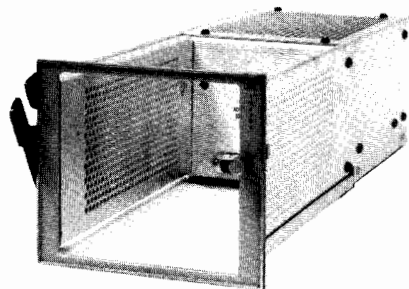

10590A

5354A Automatic Frequency Converter

The 5354A Plug-In translates not only the microwave signal but all its modulation directly to the 500 MHz window of the Model 5345A Counter (via the heterodyne technique). It allows signals with a large amount of FM to be easily characterized.

Perhaps even more powerful is its ability to take direct measurements on the carriers of very narrow microwave pulses. Pulse measurements can be easily automated.

Range: 15 MHz to 4 GHz.

Sensitivity: -10 dBm (70 mV rms) auto mode, -20 dBm typical (22 mV rms) Manual/Pulse mode to 20 dBm (2.2 V rms).

Input signal capability: CW signals. Pulsed microwave signals. Signals with very high FM content.

RF Pulse width: determined by counter GATE TIME setting.

FM Sensitivity: overlap at band edges ± 10 MHz. Maximum deviation at band center

± 250 MHz, above 1 GHz and below 500 MHz.

± 125 MHz, between 500 MHz and 1 GHz.

Operating modes: Automatic and Manual.

Automatic: measures lowest frequency signal of sufficient amplitude to trigger counter.

Manual: measures signal within selected band. Signals of sufficient amplitude between 15 MHz and 525 MHz will also be counted.

Acquisition time:

Automatic mode: CONT. WAVE, <2 ms; PULSED R.F., <1s.

Manual mode: when proper band has been selected CONT. WAVE <5 μ s; PULSED R.F. <20 ns.

Options

011: remote control via HP Interface Bus and L.O. \pm I.F. (Does not include cable)

Price
add \$325

5354A Automatic Frequency Converter

\$6250

5353A Channel C Plug-in

The 5353A Channel C Plug-In consists of a third input to the 5345A Counter. When the plug-in counting capability is combined with the mainframe gating capability it becomes quite easy to make frequency sum and frequency difference measurements.

For high speed digital applications, the greatest benefit the plug-in offers is the ability to count a specific group of events while ignoring others. This measurement is required in many applications such as computer peripheral testing and digital communications systems. It is accomplished in the events C between A and B mode by applying a start signal to CHAN A and a stop signal to CHAN B while applying the data to be counted to CHAN C.

Range: dc coupled: 0 to 500 MHz; ac coupled: 1 M Ω : 200 Hz to 500 MHz; 50 Ω : 4 MHz to 500 MHz.

Impedance: 50 Ω ; (nominal), or 1 M Ω shunted by less than 30 pF.

Sensitivity: variable to 20 mV rms sine wave and 60 mV peak-to-peak pulse. Attenuator settings are X1 and X10.

Modes of operation: Frequency C + A; Frequency C - A; Period C; Frequency C; Ratio C/A; Average Events C, A to B; Events C, A to B.

Events accuracy: Plus or minus one count worst case.

Options

011: Digital Input. Full compatibility with HP Interface Bus. Provides for digital control over all functions excluding amplifier. (Does not include cable)

Price
add \$325

5353A Channel C Plug-in

\$2500

10590A Plug-in adapter

The 10590A allows the user to interface any of the 5245 series of plug-ins (except the 5264A) to the 5345A counter. The major application is to extend the frequency range to 18 GHz via the 5255A, 5256A and 5257A Plug-Ins. In addition the adapter is "intelligent" in that it detects the plug-in being used and automatically adjusts the 5345A accordingly.

10590A Plug-in Adapter

\$1200

ELECTRONIC COUNTERS

Automatic Frequency Converter Plug-In for Model 5345A

Models 5355A & 5356A/B/C



5355A

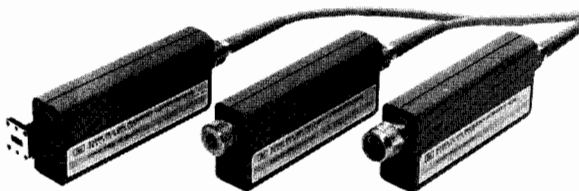

5356A/B/C

The 5355A automatic frequency converter plug in, together with the 5356A, 5356B, or 5356C frequency converter head, provides pulsed and CW frequency measurement capability to 18/26.5/40 GHz for the 5345A counter. A 0.4-1.6 GHz prescaled input offers pulsed and CW measurement for the lower microwave range even without one of the heads. The 5355A's internal microprocessor controls the measurement algorithm, computes the input microwave frequency and displays it on the eleven digit 5345A display.

Superior pulsed RF performance is provided with selectable resolution to 100 Hz and better, with accuracy to 3 kHz. Internal pulse detection circuitry sets the counters gate for maximum resolution for any pulse width down to 60 ns. External gating allows samples as small as 20 nsec for performing dynamic frequency profiling of "CHIRPS" and other FM on the RF burst. This is also an excellent CW microwave counter, providing 1 Hz resolution in 1 second. Automatic amplitude discrimination and 60 MHz FM tolerance allows this counter to correctly measure carrier frequencies in the most difficult transmitted signals.

Microprocessor control provides automatic operation and diagnostic routines for quick easy failure isolation. The front panel keyboard provides user definable offsets including an $mx \pm b$ offset mode for receiver testing where the local oscillator can be measured directly then multiplied by the appropriate harmonic number. Offsetting this by the receiver's IF allows the counter to conveniently display the tuned receiver frequency.

Ordering Information

5355A Automatic Frequency Converter Plug-In (HP-IB Standard)

5356A 18 GHz Frequency Converter Head

Option 001 High Pass Filter

Option 006 Limiter Input Protection (see p. 323)

5356B 26.5 GHz Frequency Converter Head

Option 001 18-26.5 GHz Waveguide Input

Option 006 Limiter Input Protection (see p. 323)

5356C 40 GHz Frequency Converter Head

Option 001 26.5-40 GHz Waveguide Input

Price

\$5500

\$1600

add \$125

add \$400

\$1900

add \$600

add \$400

\$2500

add \$500

- Fully automatic to 40 GHz
- Pulsed RF or CW measurement
- 60 ns minimum pulse width
- User definable offsets from front panel

Specifications

Input Specifications (Pulse and CW Mode)

	5356A	5356B	5356C
Frequency Range	1.5-18 GHz	1.5-26.5 GHz	1.5-40GHz
Sensitivity: 1.5-12.4 GHz 12.4-18 GHz 18-26.5 GHz 26.5-34 GHz 34-40 GHz	-20 dBm -15 dBm — — —	-20 dBm -15 dBm -15 dBm — —	-25 dBm -20 dBm -20 dBm -15 dBm -10 dBm
Maximum Input 1.5-12.4 GHz 12.4-18 GHz 18-26.5 GHz 26.5-40 GHz	+5 dBm +5 dBm — —	+5 dBm +5 dBm +5 dBm —	+5 dBm +15 dBm +15 dBm +15 dBm
Damage Level*	+25 dBm peak	+25 dBm peak	+25 dBm peak
Impedance	50 Ω NOMINAL	50 Ω NOMINAL	50 Ω NOMINAL
SWR: 1.5-10 GHz 10-18 GHz 18-26.5 GHz 26.5-34 GHz 34-40 GHz	<2:1 <3:1 — — —	<2:1 <3:1 <3:1 <3:1 —	<2:1 <3:1 <3:1 <3:1 <5:1
Connector	N Male	SMA Male	APC 3.5

* see Option 006 for higher damage protection.

CW Mode

	5356A/B/C Auto Mode	5356A/B/C Man Mode
FM Tolerance	15 MHz p-p (60 MHz p-p in special FM mode) rate: dc -10 MHz	80 MHz p-p rate: dc -10 MHz
AM Tolerance	Any modulation index provided the minimum signal level is greater than the counter sensitivity.	
Multiple Signal Discrimination	Automatic Amplitude Discrimination (AAD). Automatically measures largest signal provided signal is 8 dB (TYPICAL) greater than any signal within 500 MHz and 20 dB (TYPICAL) greater than any signal over range 1.5-26.5 GHz.	
Acquisition Time	5356A/B = 400 ms 5356C = 1.4 s	15 ms
LSD Displayed	1 Hz ÷ 5345A Gate Time	
Resolution	± 2 x LSD ± 10 ⁻ⁿ rms x FREQ	
Accuracy	± 2 x LSD ± 1 x 10 ⁻ⁿ rms x FREQ ± time base error x FREQ	

Pulse Mode

	5356A/B/C Input Auto Mode	5356A/B/C Input Man Mode
FM Tolerance	50 MHz p-p Chirp	80 MHz p-p Chirp
Acquisition Time	5356A/B/C Input Man Mode: 0 5356A/B Input Auto Mode: 100 μs ÷ (EXT GATE WIDTH x PRF) + 650 ms for EXT GATE ≤ 100 μs (2 ÷ PRF) + 650 ms for EXT GATE > 100 μs 5356C Input Auto Mode: (8 ÷ PRF) + 1.55s + 100 μs ÷ (EXT GATE WIDTH x PRF) for EXT GATE ≤ 100 s. (10 ÷ PRF) + 1.55 s for EXT GATE > 100 μs.	
Pulse Width Min: Max:	100 ns 20 ms	60 ns 20 ms
Pulse Repetition Frequency Min: Max:	50 Hz 2 MHz	50 Hz 2 MHz
Minimum ON/OFF RATIO	25 dB TYPICAL (35 dB TYPICAL for PRF <100 Hz)	
Maximum Video Feed-Through	15 mV p-p TYPICAL for rf burst rise and fall times >10 ns	
Minimum EXT GATE WIDTH	20 ns	
LSD Displayed	1 Hz ÷ 5345A GATE TIME	
Resolution	± 2 x LSD ± rms jitter*	
Accuracy	± 2 x LSD ± rms jitter* ± $\frac{.04}{\text{EXT GATE WIDTH}} \pm 3 \text{ KHz}$ ± Time base error x FREQ	

* rms jitter = $X + 1 \div \sqrt{(5345A \text{ GATE TIME}) (EXT \text{ GATE WIDTH})}$;
X = 100 Hz rms

For EXT GATE signals generated by the 5355A, the EXT GATE WIDTH equals the input PULSE WIDTH minus 30 ns (TYPICAL) for the 5356A/B/C input and equals input PULSE width minus 65 ns (TYPICAL) for the 5355 0.4-1.6 GHz input.

ELECTRONIC COUNTERS

Microwave Counter Limiter

Option 006

323



- High Input Level Protection
8 Watts CW (+ 39 dBm)
100 Watts Pulsed (+ 50 dBm)

- Built-In Microwave Limiter
To 26.5 GHz

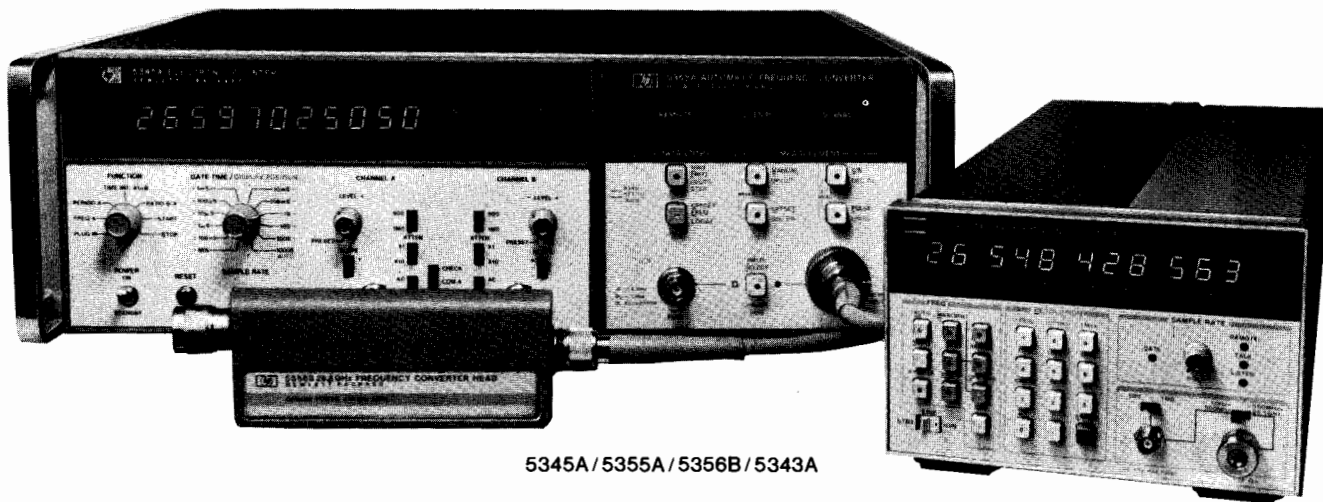

5345A/5355A/5356B/5343A

A higher level of input protection is available for Hewlett-Packard microwave counters with the Option 006 microwave limiter. The built-in Option 006 is available for the following products: 5340A, 5342A, 5343A, 5356A, 5356B.

This additional cost option is very attractive when the microwave counter resides in a high input level environment where the expensive input circuitry of the counter could be damaged.

Option 006 protects this microwave input port from damage from CW input signals up to +39 dBm (8 Watts). In addition, for those products that also measure pulsed microwave signals (5356A, 5356B), damage level protection up to +50 dBm (100 Watts) is specified.

Full specification information is shown below.

Specifications: Option 006 Microwave Counter Limiter

All specifications for Option 006 are identical to standard counter except those shown below.

	5340A*	5342A	5343A	5356A	5356B
DAMAGE LEVEL	+39 dBm (8W), 500 MHz - 6 GHz	+39 dBm (8W), 500 MHz - 6 GHz	+39 dBm (8W), 500 MHz - 6 GHz	+39 dBm (8W), 1.5 MHz - 6 GHz	+39 dBm (8W), 1.5 MHz - 6 GHz
CW	+36 dBm (4W), 6 - 18 GHz	+36 dBm (4W), 6 - 18 GHz	+36 dBm (4W), 6 - 18 GHz	+36 dBm (4W), 6 - 18 GHz	+36 dBm (4W), 6 - 18 GHz
PULSE	—	—	—	+50 dBm (100W) peak, pulse width $\geq 1 \mu\text{s}$, .001 duty cycle, TYPICAL	+34.8 dBm (3W), 18 - 26.5 GHz
SENSITIVITY	-31 dBm, 500 MHz - 10 GHz -20 dBm, 10 - 18 GHz	-21 dBm, 500 MHz - 12.4 GHz -15 dBm, 12.4 - 18 GHz	-30 dBm, 500 MHz - 12.4 GHz -24 dBm, 12.4 - 18 GHz -18 dBm, 18 - 26.5 GHz	-18 dBm, 1.5 - 12.4 GHz -11 dBm, 12.4 - 18 GHz	-18 dBm, 1.5 - 12.4 GHz -11 dBm, 12.4 - 18 GHz -10 dBm, 18 - 26.5 GHz
SWR TYPICAL	<2:1, 500 MHz - 12.4 GHz <3:1, 12.4 - 18 GHz	<2.5:1, 500 MHz - 10 GHz <3.5:1, 10 - 18 GHz	<2.5:1, 500 MHz - 10 GHz <3.5:1, 10 - 26.5 GHz	<2.5:1, 1.5 - 10 GHz <3.5:1, 10 - 18 GHz	<2.5:1, 1.5 - 10 GHz <3.5:1, 10 - 26.5 GHz
OPTION 006 COMPATIBILITY	Cannot be ordered with Option 002 Rear Inputs or Option 005 23 GHz Frequency Range. Please consult factory special to combine these options.	Cannot be ordered with Option 002 Amplitude or Option 003 Extended Dynamic Range. Also cannot be ordered with Option 005 24 GHz Frequency Range but consult factory special to combine Option 005 and 006.	NO CONSTRAINTS	Cannot order Option 001 High Pass Filter. Option 006 physically and functionally replaces Option 001.	Cannot order Option 001 18 - 26.5 GHz Waveguide Input.
PRICE**	\$400	\$400	\$400	\$400	\$400

*Range: 500 MHz to 18 GHz

**Prices apply to U.S. domestic customers only.

ELECTRONIC COUNTERS

Automatic Microwave Counters

Models 5342A & 5343A

- Microprocessor Controlled
- Automatic Measurement to 18 GHz / 26.5 GHz
- Wide FM Tolerance
- Simultaneous Display of Input Level
- High Sensitivity
- Automatic or Manual Operation



5342A

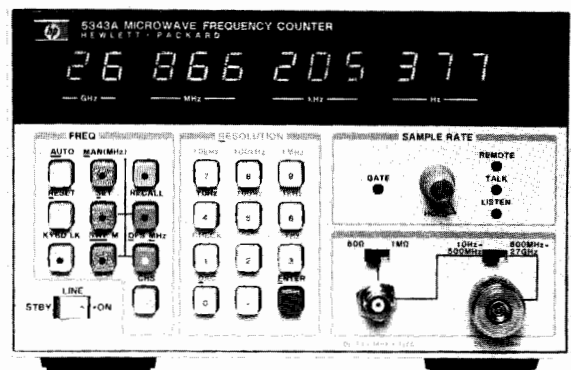

5343A



Description

The 5342A and 5343A Microwave Counters provide Automatic Frequency Measurement up to 18 or 26.5 GHz in highly portable packages. The 5342A extends to 24 GHz optionally.

The powerful and versatile microprocessor controlled keyboards can accomplish offset tasks as a standard feature as well as providing user interactive diagnostic information. The eleven-digit display is sectionalized for easy readout to one hertz resolution.

Both units utilize the Harmonic Heterodyne down conversion technique which combines the best performance features of the Heterodyne Converter and Transfer Oscillator Techniques. Now Wide FM Tolerance is achievable along with high input sensitivity and automatic amplitude discrimination. This allows the counter to automatically measure the largest signal present within the counters' spectrum while ignoring all others.

Amplitude Measurements (Option 002) (5342A Only)

Option 002 adds the ability to measure the input level of the incident sinewave signal. The instrument then displays this level in dBm. The eleven-digit LED display simultaneously presents frequency to 1 MHz resolution and amplitude to 0.1 dBm resolution. An added benefit from Option 002 is that dynamic range is extended so that frequency measurements to +22 dBm are accomplished. This extended dynamic range is also available without the amplitude measurement capability by ordering Option 003 (5342A only).

FM Tolerance

The ability to measure a carrier frequency while being frequency modulated has broad appeal in the communications industry and elsewhere. The 5342A can tolerate 50 MHz peak-to-peak worst case FM in the wide mode, or the normal mode with accompanying faster acquisition time can be selected which gives 20 MHz peak-to-peak

worst case FM. The 5343 offers a selection of three (3) acquisition times including a 200 ms "fast" acquisition time with 6 MHz peak-to-peak worst case FM Tolerance.

Offset Functions

The power and versatility of the microprocessor controlled keyboard allows the user to perform offset functions by means of a few key strokes. Frequency values to 1 Hz resolution can be added to or subtracted from the measured frequency for IF offset application and also for monitoring variances about a given frequency. The 5343A also offers an $m \times \pm b$ mode for receiver testing where the measured local oscillator can be multiplied by the appropriate harmonic number. Adding the IF as an offset has the counter displaying the received frequency.

With Option 002 installed (5342A) this offset capability can be applied to the amplitude measurements. These offset values can be recalled to the display at any time for reviewing.

Digital-To-Analog Converter (Option 004)

The ability to convert any three consecutive displayed digits (frequency or amplitude) into an analog voltage output on the rear panel is added by Option 004. This makes the monitoring of microwave oscillator frequency drift easy to make with only a strip chart recorder.

HP Interface Bus For Systems Use (Option 011)

The full power of HP-IB (IEEE 488-1975) is brought to fruition with the addition of Option 011. Front and rear panel controls can now be remotely programmed and measurement results can be outputted to HP-IB-compatible instruments, calculators, or computers. This interface also can select a given frequency in the manual mode and reduce acquisition time to typically less than 80 msec.



5342A Specifications

Signal Input

Input 1

Frequency range: **5342A:** 500 MHz to 18 GHz

5343A: 500 MHz to 26.5 GHz

Sensitivity: **5342A:** 500 MHz to 12.4 GHz: -25 dBm

12.4 GHz to 18 GHz: -20 dBm

5343A: 500 MHz to 12.4 GHz: -33 dBm

12.4 GHz to 18.0 GHz: -28 dBm

18.0 GHz to 26.5 GHz: -23 dBm

Maximum input: +7 dBm (See OPT 002, 003 for higher levels)

Impedance: 50 ohms, nominal

Connector: **5342A:** precision Type N female

5343A: APC 3.5 male with collar

Damage level: +25 dBm, peak (See OPT 006 for +39 dBm protection)

Coupling: DC to Load, AC to instrument.

SWR: < 2:1, 500 MHz-10 GHz

< 3:1, 10 GHz-18 GHz/26.5 GHz

FM tolerance: switch selectable (rear panel)

Wide: 50 MHz p-p worst case

Normal: 20 MHz p-p worst case

Narrow: (5343A only) 6 MHz p-p worst case

For Modulation Rates from DC to 10 MHz.

AM tolerance: any modulation index provided the minimum signal level is not less than the sensitivity specification.

Automatic amplitude discrimination: automatically measures the largest of all signals present, providing that signal is 6 dB above any signal within 500 MHz; 20 dB above any signal, 500 MHz-18 GHz/26.5.

Modes of operation:

Automatic: counter automatically acquires and displays highest level signal within sensitivity range.

Manual: center frequency entered to within ± 40 MHz of true value.

Acquisition Time

Automatic mode:

Narrow FM 200 ms worst case (5343A only)

Normal FM 530 ms worst case

Wide FM 2.4 s worst case

Manual mode: 80 ms after frequency entered

Input 2

Frequency range: 10 Hz to 520 MHz direct count.

Sensitivity: 50 Ω : 10 Hz to 520 MHz: 25 mV rms. 1 M Ω : 10 Hz to 25 MHz: 50 mV rms.

Impedance: selectable 1 M Ω , <50 pF or 50 Ω nominal.

Coupling: AC.

Connector: Type BNC female.

Maximum input 50 Ω : 3.5 V rms (+24 dBm) or 5 V DC, fuse protected

1 M Ω : 200 V DC + 5 V rms

Time Base

Crystal frequency: 10 MHz.

Stability

Aging rate: <1 x 10⁻⁷/month

Temperature: < ± 1 x 10⁻⁶ over the range 0°C to 50°C

Short term: <1 x 10⁻⁹ for 1 second averaging time.

Line variation: < ± 1 x 10⁻⁷ for 10% change from nominal.

Output frequency: 10 MHz, ≥ 2.4 V square wave (TTL compatible) 1.5 p-p V into 50 Ω available from rear panel BNC.

External time base: requires 10 MHz, 2.0 V p-p sine wave or square wave into 1 K Ω via rear panel BNC connector. Switch selects either internal or external time base.

Optional Time Base (Option 001)

Crystal frequency: 10 MHz.

Stability

Aging rate: <5 x 10⁻¹⁰/day after 24-hour warmup

Temperature: <7 x 10⁻⁹ over the range 0°C to 50°C

Short term: <1 x 10⁻¹⁰ for 1 second averaging time

Line variation: <1 x 10⁻¹⁰ for 10% change from nominal

Warm-up: <5 x 10⁻⁹ of final value 20 minutes after turn-on, at 25°C.

General

Accuracy: ± 1 count \pm time base error.

Resolution: front panel push buttons select 1 Hz to 1 MHz

Display: 11 digit LED display, sectionalized to read GHz, MHz, kHz, and Hz.

Self-check: selected from front panel pushbuttons displays 75 MHz for resolution chosen.

Frequency offset: selected from front panel pushbuttons. Displayed frequency is offset by entered value to 1 Hz resolution.

Frequency multiply: (5343A only) (mx \pm b) measured data is multiplied by any integer up to 99. Offset can then be added or subtracted. Front panel selectable.

Totalize (5343A only): input 2 can totalize at rates up to 520 MHz. Readout on the fly is controlled by front panel or HP-1B.

Sample rate: variable from less than 20 ms between measurements to HOLD which holds display indefinitely.

IF out: rear panel BNC connector provides 25 MHz to 125 MHz output of down-converted microwave signal.

Power requirements: 100/120/220/240 V rms, +5%, -10%, 48-66 Hz; 100 VA max.

Weight: net 9.1 kg (20 lb.). Shipping 12.7 kg (28 lb.).

Size: 133 mm H x 213 W x 498 mm D (5.25" x 8.39" x 19.6").

Amplitude Measurement (OPT 002) (5342A Only)

Input 1

Frequency range: 500 MHz-18 GHz.

Dynamic range (frequency and level):

-22 dBm to +22 dBm 500 MHz to 12.4 GHz

-15 dBm to +22 dBm 12.4 GHz to 18 GHz

Maximum operating level: +22 dBm

Damage level: +25 dBm, peak

Resolution: 0.1 dBm

Accuracy: ± 1.5 dB (excluding mismatch uncertainty).

SWR: <2:1 (amplitude measurement).

<5:1 (frequency measurement).

Measurement time: 100 ms + frequency measurement time.

Display: simultaneously displays frequency to 1 MHz resolution and level. (Option 011 provides full frequency resolution on HP-1B).

Input 2 (50 Ω impedance only)

Frequency range: 10 MHz-520 MHz.

Dynamic range (frequency and level): -17 dBm to +20 dBm

Damage level: +24 dBm.

Accuracy: ± 1.5 dB (excluding mismatch uncertainty).

SWR: <1.8:1.

Measurement time: 100 ms + frequency measurement time.

Display: Simultaneously displays frequency and input level.

Extended Dynamic Range (OPT 003) (5342A Only)

Frequency range: 500 MHz to 18 GHz.

Sensitivity: 500 MHz to 12.4 GHz: -22 dBm

12.4 GHz to 18 GHz: -15 dBm

Maximum operating level: +22 dBm

Dynamic range: 500 MHz to 12.4 GHz: 44 dB

12.4 GHz to 18 GHz: 37 dB

Damage level: +25 dBm, peak

SWR: <5:1

Options and Accessories

	Price
001: High Stability Time Base	add \$675
002: Amplitude Measurement (5342A Only)	add \$1100
003: Extended Dynamic Range (5342A Only)	add \$475
004: Digital-To-Analog Converter	add \$325
005: Frequency Extension to 24 GHz (5342A Only)	add \$425
006: Limiter Input Protection (+39 dBm) see page 323	add \$400
011: Digital Input/Output (HP-1B) (Cable Not Incl)	add \$425
908: Rack Mounting Adapter Kit	\$45
K70-59992A: Rack Mounting Adapter Kit With Slot For access to front connectors from rear.	
10842A: Extender Board Kit	\$325
5342A Frequency Counter	\$5500
5343A Frequency Counter	\$6400



ELECTRONIC COUNTERS

Automatic Microwave Counter

Model 5340A

- Single input 10 Hz to 18 GHz
- Automatic amplitude discrimination
- High sensitivity—35 dBm
- Optional extension to 23 GHz
- High AM and FM tolerance
- Exceptional reliability

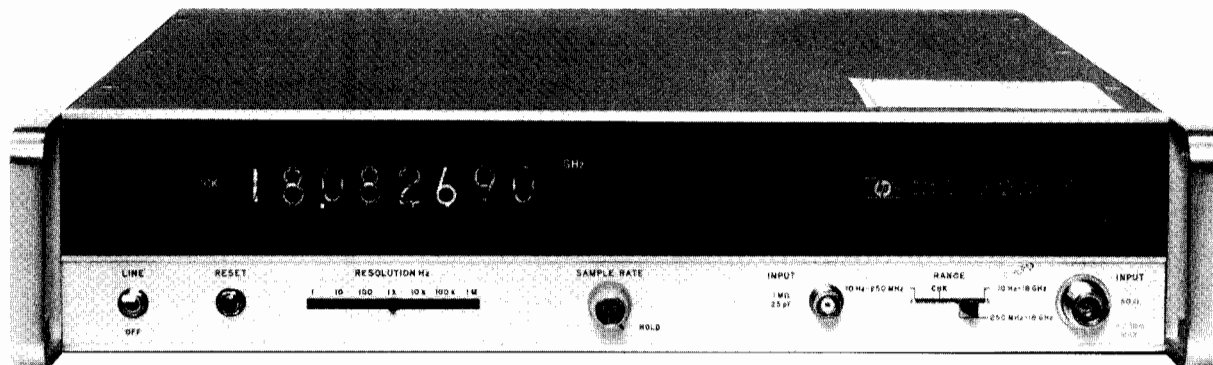

5340A



The 5340A Frequency Counter provides an easily used, versatile instrument for the direct measurement of frequencies from 10 Hz through 18 GHz via a single input connector. Utilizing microwave samplers incorporated in advanced phase-lock loops, this counter excels in many important specification parameters. It is therefore suited to a wide range of applications.

The exceptional sensitivity of this instrument enhances measurement in the microwave field, where signals are commonly low level and many times are connected via directional couplers or lossy devices. Wide tolerance of AM, FM., and residual noise insure accurate measurement of microwave carrier frequencies despite the presence of these deviations. Automatic amplitude discrimination allows the 5340A to choose the largest signal in a spectrum (250 MHz to 18 GHz) and measure only that signal's frequency, ignoring all others.

Access to the HP Interface Bus via Option 011 provides a particularly flexible system interface. The ability to program octave range via this input allows reduction of acquisition time to typically less than 40 ms. AN 181-1 describes the use of a calculator-controlled measurement system built around the HP Interface Bus for microwave component testing.

5340A Specifications

Signal Input

Input 1

Range: 10 Hz to 18 GHz.

Symmetry: sinewave or squarewave input (40% duty factor, worst case).

Sensitivity: -30 dBm, 10 Hz to 500 MHz; -35 dBm, 500 MHz to 10 GHz; -25 dBm, 10 to 18 GHz.

Dynamic range: 37 dB, 10 Hz to 500 MHz; 42 dB, 500 MHz to 10 GHz; 32 dB, 10 GHz to 18 GHz.

Impedance: 50Ω.

VSWR: <2:1, 10 Hz-12.4 GHz; <3:1, 12.4-18 GHz.

Connector: Precision Type N.

Coupling: dc to load, ac to instrument.

Damage level: +30 dBm. Total power (ac + dc) not to exceed 1 watt. See Option 006 for up to +39 dBm protection.

Acquisition time: <150 ms mean typical.

Input 2

Range: 10 Hz-250 MHz direct count.

Sensitivity: 50 mV rms. 150 mV p-p pulses to 0.1% duty factor; minimum pulse width 2 ns.

Impedance: 1 MΩ shunted by <25 pF.

Connector: type BNC female.

Coupling: ac

Maximum input: 200 V rms, 10 Hz to 100 Hz; 20 V rms, 100 Hz to 100 kHz; 2 V rms, 100 kHz to 250 MHz.

Automatic amplitude discrimination: automatically selects the strongest of all signals present (within 250 MHz to 18 GHz phase-lock range), providing signal level is: 6 dB above any signal within 200 MHz; 10 dB above any signal within 500 MHz; 20 dB above any signal, 250 MHz-18 GHz.

Maximum AM modulation: any modulation index as long as the minimum voltage of the signal is not less than the sensitivity specification.

Time Base

Crystal frequency: 10 MHz.

Stability

Aging rate: <3 × 10⁻⁷ per month.

Short term: <5 × 10⁻¹⁰ rms for 1 second averaging time.

Temperature: <±2 × 10⁻⁶ over the range of 0°C to 50°C.

Line variation: <±1 × 10⁻⁷ for 10% line variation from nominal.

Output frequency: 10 MHz, ≥2.4 V square wave (TTL compatible) available from rear panel BNC.

External time base: requires 10 MHz approximately 1.5 V p-p sine wave or square wave into 1 kΩ via rear panel BNC. Switch selects either internal or external time base.

Optional time base (Opt 001) aging rate: <5 × 10⁻¹⁰ per day after 24 our warm-up for less than 24 hour off-time.

General

Accuracy: ±1 count ± time base error.

Resolution: front panel switch selects 1 MHz, 100 kHz, 10 kHz, 1 kHz, 100 Hz, 10 Hz, or 1 Hz.

Display: eight in-line long life display tubes with positioned decimal point and appropriate measurement units of kHz, MHz, or GHz.

Self check: counts and displays 10 MHz for resolution chosen.

Sample rate: controls time between measurements. Continuously adjustable from 50 ms typical to 5 seconds. HOLD position holds display indefinitely. RESET button resets display to zero and activates a new measurement.

Operating temperature: 0°C to 50°C.

Power: 115 V or 230 V ±10%, 48-66 Hz, 100 VA.

Weight: net, 11.3 kg (25 lb). Shipping, 14.1 kg (31 lb).

Size: 88.2 H × 425 W × 467 mm D (3.47" × 16.75" × 18.39").

Options

001: High Stability Time Base

002: Rear Panel Connectors

005: Frequency Extension to 23 GHz

006: Limiter Input Protection (+39 dBm), see page 323

011: Remote Programming-Digital Output (HP-IB). Cable not included, see page 30.

908: Rack Flange Kit

5340A Frequency Counter

Price

add \$725

add \$125

add \$550

add \$400

add \$390

add \$25

\$8600

- Capable of 100,000 measurements / second

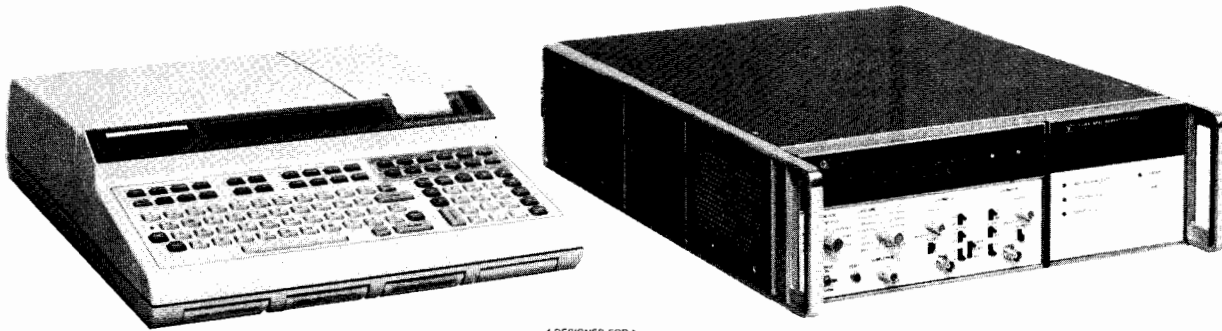

5391A Frequency and Time Data Acquisition System

General

The HP5391A Frequency and Time Data Acquisition System combines the power of the HP5345A Universal Counter with the speed and storage capability of the HP5358A Measurement Storage Plug-In to allow you to make and store frequency or time measurements at rates as high as 100,000 measurements per second. The 5391A can help you characterize pulse width jitter by measuring and storing each pulse width and then computing statistical parameters such as min, max, mean, and standard deviation. Other application areas include nuclear time of flight studies, explosive testing and characterization, and frequency profile measurements.

The 5391A is a compact HP-IB system consisting of the 5345A Universal Counter with the 5358A Measurement Storage Plug-In, the 9825B Computing Controller, and a versatile software package providing utility application routines and diagnostic service routines.

Application Example

Frequencies, periods, ratios, and time intervals may be measured and stored by the 5391A. A typical application, shown in the figure, is to measure and store every pulse width in a burst of pulses:

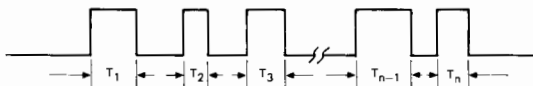

The 5345A counter makes a single shot time interval measurement (2 nanosecond resolution) for each pulse width. During the dead time between successive time intervals, the 5345A transfers the data to the 5358A Measurement Storage Plug-In. The time required for this transfer is $7 \mu\text{s} + 1 \mu\text{s}/\text{digit transferred}$. The graph plots transfer time required versus the time interval measured. If the dead time immediately following a measured time interval is greater than the required transfer time, the 5391A can make the measurement.

The 5391A, with its 9825B Controller, is capable of making and storing up to 1200 consecutive measurements for time intervals less than 2 milliseconds. Above 2 milliseconds, the 8K memory of the 5358A will limit the number, depending on the time interval.

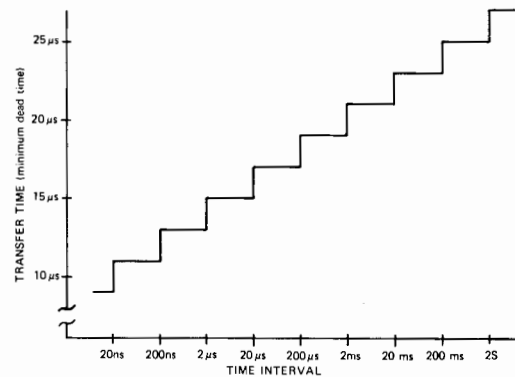

When the desired number of measurements in a run exceeds the maximum allowable, the maximum is taken and then stored as a block on the 9825B cassette. Subsequent blocks of measurements are taken and stored on cassette until the total desired number of measurements has been accumulated. The time required to transfer the measurement data from the 5358A to the 9825B and store it on cassette is on the order of seconds. During this time, no measurements can be made. The total number of measurements is program selectable from 1 to 9999.

Systems Options

325: Deletes 9825B Controller (as well as HP-IB Interface)

Price

less \$8,700

Ordering Information

5391A Basic System Includes:

- 5345A Option 011 Electronic Counter
- 5358A Measurement Storage Plug-in with 8K bytes of memory
- 9825B Computing Controller (Includes 32K Bytes of Memory, and all needed ROMs)
- 98034A HP-IB Interface
- System Software Cartridge
- System and Instrument Manuals

5391A Basic System

\$22,225

ELECTRONIC COUNTERS

Universal Time Interval Counter

Model 5370A

- 20 ps single shot time interval counter
- Statistics
- Automatic calibration of systematic errors
- Positive or negative time intervals
- Frequency and period to 100 MHz

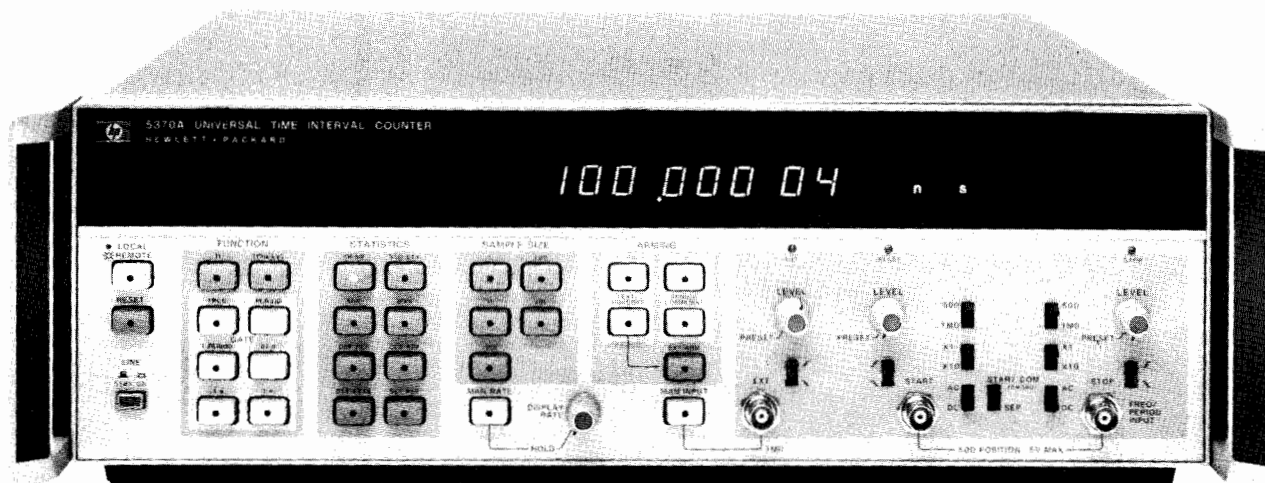

5370A



The 5370A Universal Time Interval Counter represents the highest resolution single-shot time interval counter available today. The counter utilizes a new concept of phase locked vernier interpolation, which allows single-shot time interval measurements with ± 20 ps resolution. This technique allows positive, zero and negative time intervals to be measured. High resolution period and frequency measurements may also be made.

All major front panel controls including trigger level are programmable by means of the Hewlett-Packard Interface Bus (HP-IB).

User convenience is increased by the inclusion of a microprocessor, which extends the usefulness of the instrument by offering the statistical functions of mean, standard deviation, max, and min for repetitive time intervals. A user-defined time interval reference is included for the cancellations of systematic errors.

The high resolution time interval capability makes the instrument ideal for IC testing, radar and laser ranging, digital communications, ballistics and nuclear measurements.

Functions

TI: Time Interval function measures time difference from the START to the STOP channel. In the \pm TI mode, the counter will measure the time from the first event in either channel to the first event in the other channel. The microprocessor affixes a negative sign to the display if the stop channel event occurred first.

The negative time feature allows applications like differential phase measurement between two waveforms to be continuously monitored even though the phase changes from a positive to a negative drift. Statistical functions are available in both TI modes.

Trig Lvl: Measures the trigger levels of START and STOP channels and displays both levels simultaneously with 10 mV resolution. Additional equipment like oscilloscopes or DVM's is not required.

Freq: Measures the frequency of the STOP channel signal by taking the reciprocal of a period average. Both timed gates and single period gates are available. In the single period mode, resolution may be improved by using a larger sample size. Statistics are available in the single period mode.

The exceptionally high resolution (11-12 digits per second) of the 5370A makes the instrument ideal for directly measuring the drift of oscillators and other applications requiring exceptionally high frequency resolution.

Period: Measures the period average of STOP channel events. Statistics are available in the single period mode, but not with timed gates.

Statistics

Statistical functions allow much more complete characterization of time intervals. In addition to the mean, both the max and min within a selected sample size are available and also the standard deviation. In many cases, these parameters are of more interest than the mean. For example, in a digital communications system, the limits of pulse jitter as described by the max and min could be of primary interest. For a normal distribution of jitter, the standard deviation gives the rms jitter directly.

Sample size: push-button selectable to 1, 100, 1K, 10K, and 100K samples.

Mean: displays the mean estimate which is the average for the selected sample size.

Std dev: displays a standard deviation estimate for the selected sample size.

Min: displays the minimum time interval measured within the selected sample size.

Max: displays the maximum time interval measured within the selected sample size.

Arming

Extremely flexible arming greatly extends the usefulness of the 5370A into new applications. "Hold-off" features allow complex pulse trains to be measured by preventing "stop channel" arming until the removal of an external "gating" signal. An example could be the measurement of time from a radar or laser send pulse to the return pulse, where depending on the range of the object, several return pulses may occur before the return pulse of interest.

Other methods of arming allow the counter to be externally gated by an input waveform which very precisely controls both measurement duration and the time position at which the measurement occurs. Applications are in the frequency profiling of VCO's, pulsed rf bursts, or sweep linearity investigations.

The following modes of arming are available:

+TI

Internally armed – no hold-off

Externally armed – no hold-off

Externally armed – external hold-off

\pm TI

External arming

Internal arming



Programming

Major controls are programmable as standard via the HP-IB making the 5370A an economical, versatile unit for systems applications.

Data Output Rate

- 1) HP-IB: 10-20 readings per second.
Dead time between measurements within a sample is 330 μ s.
- 2) Fast Binary: 6 kHz
Dead time between measurements is 165 μ s.

5370 Specifications

Sensitivity: 100 mV p-p, 35 mV rms sine wave \times attenuator setting.

Impedance: Selectable 1 M Ω //30 pF or 50 Ω nominal.

Trigger level: -1.3V to 0.5V, adjustable; 10 mV displayed resolution.

Trigger slope: independent selection of + or - slope.

Attenuators: $\times 1$ and $\times 10$ nominal.

Dynamic range (preset):

- 50 Ω $\times 1$:** 100 mV to 1 V p-p pulse; **$\times 10$:** 1 V to 7 V p-p pulse
1 M Ω $\times 1$: 100 mV to 1 V p-p pulse; **$\times 10$:** 1 V to 10 V p-p pulse
 Dynamic range for rms sine wave is one-third of the above values.

Signal operating range:

- 50 Ω $\times 1$:** -2.5 V to 1 V; **$\times 10$:** -7 V to 7 V
1 M Ω $\times 1$: -2.5 V to 1 V; **$\times 10$:** -25 V to 10 V

Coupling: AC or DC switch selectable.

Minimum pulse width: 5 ns

Maximum input:

- 50 Ω $\times 1$:** ± 7 V DC
 7 V rms below 5 MHz
 3.5 V rms (+24 dBm) above 5 MHz
 $\times 10$: ± 7 V DC, 7 V rms (+30 dBm)
1 M Ω $\times 1$: ± 350 V DC
 250 V rms to 20 kHz decreasing to 3.5 V rms
 above 5 MHz
 $\times 10$: ± 350 V
 250 V rms to 20 kHz decreasing to 35 V rms
 above 5 MHz

Common Input

All specifications are the same as for separate operation with the following differences:

Impedance: 1 M Ω becomes 500 k Ω shunted by <60 pF. 50 Ω same as in separate.

Sensitivity (preset):

- 50 Ω $\times 1$:** 200 mV p-p, 70 mV rms; **$\times 10$:** 2 V p-p, 700 mV rms
1 M Ω : same as in separate

Dynamic range (preset):

- 50 Ω $\times 1$:** 200 mV to 2 V p-p pulse; **$\times 10$:** 2 V to 5 V p-p pulse
1 M Ω : same as in separate

Maximum input:

- 50 Ω ± 5 V DC or 5 V rms
 1 M Ω same as in separate

Attenuators: Becomes $\times 2$ and $\times 20$ for 50 Ω

Time Interval Measurements

Time Interval Range

- \pm **Mode:** -10 seconds to +10 seconds including 0 seconds
 + **Only mode:** 10 ns to 1 seconds
Sample size. (N): 1, 100, 1000, 10,000, 100,000
 1 to 16777215 via HP-IB

Statistics: Mean, Standard Deviation, Maximum, Minimum. Time between measurements 330 μ s; minimum rise time 1 ns

Least significant digit displayed: 20 ps / \sqrt{N}

Resolution:

$(\pm 100 \text{ ps rms} \pm \text{Start Trigger Error} \pm \text{Stop Trigger Error}) \div \sqrt{N}$

Accuracy: \pm Resolution \pm Time Base Error \times Time Interval
 \pm Trigger Level Timing Error ± 1 ns Systematic

Trigger error =

$$\sqrt{(150 \mu\text{V})^2 + e_n^2}$$

Input voltage slew rate (V/s) at trigger point secs rms

where 150 μ V is the typical rms input amplifier noise on the 5370A and e_n is the rms noise of the input signal for a 500 MHz bandwidth.

Trigger level timing error =

25 mV \div Input voltage slew rate (V/s) at trigger point

Frequency Measurements

Frequency range: 0.1 Hz to 100 MHz

Timed gates

Internal gate time: 1 period, 0.01, 0.1, 1 seconds

Least significant digit displayed: $\frac{20 \text{ ps}}{\text{Gate Time}} \times \text{FREQ}$

Resolution:

$$\pm \frac{100 \text{ ps}}{\text{Gate Time}} \times \text{FREQ} \pm 1.4 \frac{\text{Trigger Error}}{\text{Gate Time}} \times \text{FREQ}$$

Accuracy: \pm Resolution \pm (Time Base Error) \times FREQ
 \pm (100 ps Systematic \div Gate Time) \times FREQ

Statistics: Mean

Sample Mode (Single Period)

Sample size: same as Time Interval

Least significant digit displayed: 20 ps / $\sqrt{N} \times \text{FREQ}$

Resolution:

$$\pm \frac{100 \text{ ps}}{\text{Gate Time}} \times \text{FREQ} \pm 1.4 \frac{\text{Trigger Error}}{\text{Period} \sqrt{N}} \times \text{FREQ}$$

Accuracy: \pm Resolution \pm (Time Base Error) \times FREQ
 \pm (100 ps Systematic \div Period) \times FREQ

Statistics: Mean, Standard Deviation, Maximum, Minimum.

External Gate

Gate input: 20 ns to 1 seconds/sample size

Resolution and accuracy estimates may be made with the same specifications as Timed Gates above.

Period Measurements

Period range: 10 ns to 10 seconds

Timed gates

Internal gate time: 1 period, 0.01, 0.1, 1 seconds

Least significant digit displayed: $\frac{20 \text{ ps}}{\text{Gate Time}} \times \text{PERIOD}$

Resolution:

$$\pm \frac{100 \text{ ps}}{\text{Gate Time}} \times \text{PERIOD} \pm 1.4 \frac{\text{Trigger Error}}{\text{Gate Time}} \times \text{PERIOD}$$

Accuracy: \pm Resolution \pm Time Base Error \times PERIOD
 \pm (100 ps Systematic \div Gate Time) \times PERIOD

Sample Mode (Single Period)

Sample size (N): Same as Time Interval.

Least significant digit displayed: 20 ps / \sqrt{N}

Resolution: $\pm 100 \text{ ps} / \sqrt{N} \pm 1.4 \text{ Trigger Error} / \sqrt{N}$

Accuracy: \pm Resolution \pm Time Base Error \times PERIOD
 $\pm 100 \text{ ps Systematic}$

Statistics: Mean, Standard Deviation, Maximum Minimum

External Gate

Gate input: 20 ns to 10 seconds

Resolution and accuracy estimates may be made with the same specifications as timed measurements above.

Time Base (HP Model 10811A)

Standard High Stability Oven Oscillator

Frequency: 10 MHz

Aging: $< 5 \times 10^{-10}$ per day

Temperature: $< 2.5 \times 10^{-9}$ 0 $^\circ$ C to 50 $^\circ$ C

General

Display: 16 digits, suppressed leading zeros.

Size: 133 H \times 426 W \times 521 mm D (5.25" \times 16.75" \times 20.5").

Weight: 32 lbs.

Power requirements: 100, 120, 220, or 240 V ac $\pm 5\%$ -10%, 48 to 66 Hz, less than 250 VA.

Front handles: supplied with instrument.

5370A Universal Time Interval Counter

\$8750

Option 908: Rack Flange Kit for use without handles

add\$25

Option 913: Rack Flange Kit for use with supplied front handles

add\$31

10870A: Service Kit Accessory

add \$450



ELECTRONIC COUNTERS

Time Interval Probes

Model 5363B

- Solves major T.I. problems
- Precisely defines trigger points
- Greatly improves dynamic range

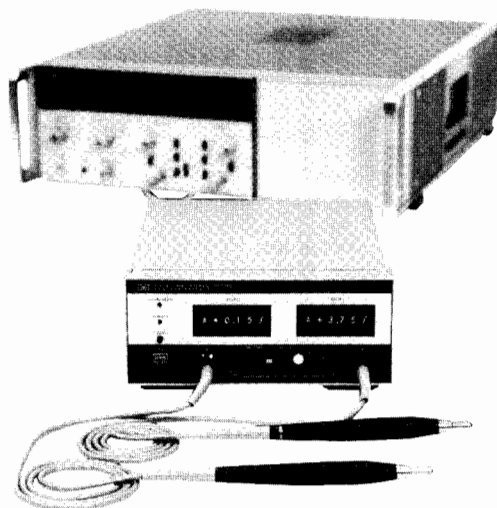

HP-IB programmable Time Interval Probes



Repeatable Measurements

The 5363B provides the necessary input signal conditioning to allow a precision time interval counter to make highly accurate and repeatable measurements on time varying waveforms. No longer are counters restricted to "event" type measurements such as pulse width or pulse to pulse. Counters such as the 5345A, 5328A, 5335A, and 5370A can now be adapted to make measurements such as rise time, fall time, slew rate, propagation delay and phase jitter analysis.

Trigger Point Calibration

A unique scheme of Trigger Point Calibration is used instead of hysteresis compensation to insure that the value selected on the digital dials or via the HP-IB is the actual triggering point rather than some unspecified "best estimate" of the trigger point or the center of the hysteresis window.

20 V Operating Range with 10 mV Resolution

Greatly improved dynamic range allows the trigger point to be selected in 10 mV increments from -9.99 V to +9.99 V covering the range of most commonly used logic circuits. The use of attenuators on traditional T.I. counters to extend their range increases the effective hysteresis window by the same attenuation amount. This prevents trigger points close to the top or bottom (i.e. 10% or 20% points) of the waveform from being selected and sometimes creates "holes" where certain trigger points cannot be selected at all. The wide dynamic range of the 5363B overcomes these problems.

Minimized Circuit Loading

Active high impedance, low capacitance probes minimize circuit loading and pulse distortion. Each probe contains both a start and stop channel so that a rise time into a device can be measured with one probe, the rise time out of the device with the other and the propagation delay through the device can be measured between the probes.

Systematic Timing Errors Eliminated

Delays through probes, cables and the inherent differential delays inside the counter's timing channels (i.e., <700 ps in 5345A) limit the absolute accuracy of the time interval measurement to some unknown but fixed amount.

The 5363B calibration procedure equalizes out such system delays and allows the counter and probes to be set for 0.0 ns. When a counter with a minimum T.I. range is used (such as HP 5345A or 5328A) a fixed offset of 10.0 ns can be switched in allowing the counter to measure down to zero time interval.

- Equalizes system timing errors
- Active probes minimize circuit loading
- Measures to zero time interval

Automatic Operation

Under desktop computer control the standard HP-IB capability allows the probes and a counter to perform a wide variety of automatic waveform analysis. In the lab or production line complex measurements or go-no-go decisions can be made with push button simplicity.

Specifications

Operating range: ± 10 V.

Minimum input voltage: ± 100 mV above and below the trigger point.

Damage level: ± 30 V.

Voltage resolution: 10 mV.

Time resolution: depends on counter used (typically 10 ps with 5345A T.I. Avg.; 35ps single shot with the 5370A).

Impedance: 1 M Ω shunted by <20 pF.

Effective bandwidth: 350 MHz (or 1 ns rise time).

Minimum pulse width: input signal must remain below and above trigger point for at least 5 ns (i.e., max repetition rate of square wave = 100 MHz).

Output to counter: separate start and stop channels, -0.5 V to +0.5 V into 50 Ω , slew rate through zero volts is greater than 0.25 V/ns.

Trigger level outputs: trigger point setting ± 75 mV.

Delay compensation range: 2 ns adjustable about 0.0 ns or 10.0 ns.

Power: 100, 120, 220, or 240 V ac ± 5 -10%; 48 to 440 Hz; 40 VA max.

Weight: net 3.0 kg (6.5 lb); shipping 5.5 kg (12 lb).

Dimensions: rack height 88.1 mm (3.5"); half rack module 212 mm (8.38"); depth 248 mm (11.6"). Probe length 122 cm (4 ft.).

Environmental: operating temperature 0°C to 55°C.

Absolute accuracy

$$\begin{aligned} \pm 1 \text{ ns} \pm & \frac{\text{START trigger level accuracy} + \text{START noise trigger error}}{\text{START signal slew rate at trigger point}} \\ & \pm \frac{\text{STOP trigger level accuracy} + \text{STOP noise trigger error}}{\text{STOP signal slew rate at trigger point}} \end{aligned}$$

Trigger Level Accuracy:

Trigger Level	-5 to +9 V	-5 V to -10 V	+9 V to +10 V
*Trigger level accuracy	± 8 mV ± 0.4 mV/ $^{\circ}$ C $\pm 0.15\%$ trigger voltage	$\pm 1\%$ trigger voltage	50 mV
*Differential trigger level accuracy	± 3 mV $\pm 0.3\%$ trigger voltage	$\pm 1\%$ trigger voltage	100 mV

*Differential trigger level accuracy applies when both START and STOP trigger level voltages are set equal and identical waveforms applied.

**After calibration and within the range between 100 mV or 8% whichever is greater from the top or bottom of the input signal.

Noise trigger error: $\sqrt{(125 \mu\text{V})^2 + e_n^2}$ volts where 125 μV is the typical input noise on the 5363B and e_n is the input signal noise for a 350 MHz bandwidth.

Recommended Counters

5345A Electronic Counter; 2 ns single shot T.I., True T.I. averaging	Price \$6600
5328A Opt. 040 Universal Counter; 10 ns single shot T.I., True T.I. averaging	\$2075
5370A Universal Time Interval Counter 20 ps single shot	\$8750
5335A Universal Counter; 2 ns single shot T.I.	\$3350

5363B Accessories

10229A Hook Tip	\$15
10218A BNC BNC to Probe Adapter	\$20
1250-0655 BNC Tee to Probe Adapter	\$21.50
10100C 50 Ω Feedthru termination for non-50 Ω T.I. counter	\$25
10821A Accessory Kit with 2 each of above plus two 8710-0661 HP Probe Tips	\$125

5363B Time Interval Probes

\$3250

ELECTRONIC COUNTERS

200 MHz Universal Counter

Model 5335A



- A High Performance 200 MHz/2ns Universal Counter
- Built-In Automatic Rise Time, Duty Cycle, Pulse Width, Slew Rate and Phase Measurements
- Unique Advanced Automatic Triggering Capabilities
- HP-IB plus Math and Statistics Functions Standard



5335A



Remarkable Automatic Measurement Power

The HP-5335A is an advanced universal counter with automatic measurement power built-in. Designed either for bench or systems applications, the counter has 16 front-panel measurement functions, plus four "phantom" functions. All automatically selected by push button or by HP-IB. These twenty functions, plus greatly expanded arming and triggering capability make the 5335A a most powerful universal counter. In addition, math and statistics features, matched Channel A and B input amplifiers, and HP-IB, are all included in the standard unit, making the 5335A easily the most advanced universal counter available at its price.

The 5335A has all the measurement functions normally found in a universal counter. Plus, it has automatic operation. Beyond these features, it possesses new measurements not previously included in this type of instrument.

Pulse Characterization Measurements

Most HP universal counters provide you with a fairly complete measurement set. The 5335A possesses all these expected universal measurements, and does them better than ever before. But, beyond the expected measurement set, the 5335A has the ability to automatically measure waveform characteristics for various applications. Op Amp Characterization is one area where a number of measurements are needed to define the amplifiers performance. Using the 5335A and a signal source, rise and fall times, output slew rate, and propagation times can be measured with one test set-up. Also, duty cycle can be measured to see the distortion on a square wave through the amplifier due to different rising and falling slew rates. Lastly, phase measurements are also push-button selectable and automatically performed by the counter.

Complete Triggering Capability

To get good measurement results, a counter must properly trigger on the input signal. The 5335A employs both manual and automatic trigger modes to quickly and easily set the right trigger points.

Manual Triggering

The counter has a ± 5 VDC range to help reduce input attenuator use for most input signals, including TTL.

Automatic Triggering

Two auto trigger modes help you trigger automatically. Just press *auto trig* or select auto trig on the HP-IB; and the counter automatically selects 10%-90% Rise/Fall time trigger points, 50% phase trigger points, or the pre-set value of your choice. Then it tracks the signal's DC offset continuously to stay on the right trigger point. Option 040 allows programmability of trigger levels via HP-IB.

Trigger Level DVM

Built-in to the basic counter. Just press TRG LVL to see both input channel trigger levels displayed.

A Full Set of Universal Measurement Functions

In addition to waveform characterization features, the 5335A has an extremely wide set of measurement functions covering frequency, time, events and volts. These functions let you characterize signals quicker and more thoroughly than ever before possible.

Frequency

Frequency is the most common measurement performed by counters. The 5335A measures to 200 MHz in Channel A, 100 MHz in Channel B, and 1.3 GHz in its optional Channel C. Due to the counter's advanced design and reciprocal measurement technique, resolution is a constant 9 digits per second of gate time across its entire measurement range.

Time

In a universal counter, a time interval measurement equates to a stopwatch measurement started and stopped by unique events. Precision is dependent on the counter's circuitry.

To ensure precision, the 5335A has matched custom input amplifiers to greatly reduce trigger errors that might be produced if the start and stop signals were amplified differently. Further, the counter employs an analog interpolation technique that turns its 10 MHz clock into the equivalent of a 1 GHz time base. The 5335A is thus able to resolve single shot time interval measurements to better than 2 nanoseconds (100 ps with averaging). This analog interpolation eliminates the need found in some counters for a phase-modulated (jittered) time base for time interval average measurements.

Math and Statistics

Averaging techniques are often used to extend the resolution of a counter. For averaging, the 5335A provides sample sizes of $N = 100$ or $N = 1,000$. Best of all, averaging can be employed for all measurements except phase. In addition to mean, and selection of sample size, the counter takes standard deviations of the current measurement for the sample size selected.

Math functions are another built-in feature that provide operator convenience. These functions let you convert the display into direct indications of parameters like flow, speed, pressure, and temperature. Additionally, the counter remembers the offset, scale, and normalize factors for each measurement function.



Model 5335A (cont.)

Specifications**Input Characteristics (Channel A and B)****Range**

DC coupled, 1 to 100 MHz.

AC 1 M Ω , 30 Hz to 100 MHz.AC 50 Ω , 200 KHz to 100 MHz

NOTE: Channel A range 200 MHz when in Frequency A and Ratio modes.

Sensitivity (X1):

25 mV rms sinewave

75 mV peak-to-peak pulse at minimum pulse width of 5 ns.

Dynamic Range (X1):

75 mV to 5V peak-to-peak, to 100 MHz.

75 mV to 2.5V peak-to-peak, >100 MHz.

Signal Operating Range (X1, DC):

-5V dc to +5V dc.

Trigger Level Range (X1):**Auto Trigger OFF:**

Preset: Set to 0V dc NOMINAL

Adjustable: -5V dc to +5V dc

Auto Trigger ON:

Preset: Set to nominal 50% point of input signal.

Adjustable: nominally between + and - peaks of input signal.

Auto Trigger (X1):**Range (50% duty cycle):**

DC coupled, 30 Hz to 200 MHz.

AC 1 M Ω , 30 Hz to 200 MHzAC 50 Ω , 200 kHz to 200 MHz**Minimum signal:** 100 mV rms.**Duty cycle range:** 10% to 90%.**Response time:** 3 seconds, typical.

NOTE: Auto Trigger requires a repetitive signal.

Coupling: AC or DC, switchable.**Impedance:** 1M Ω , nominal, shunted by <35pf or 50 Ω nominal, switchable. In COMMON A, 1M Ω is shunted by <50pf.**Attenuator:** X1 or X10 nominal, switchable.**Slope:** Independent selection of + or - slope.**Channel input:** SEPARATE or COMMON A, switchable.**Frequency A****Range:** 0 to 200 MHz, prescaled by 2**LSD Displayed:**

$$\frac{1 \text{ ns}}{\text{Gate Time}} \times \text{FREQ. (e.g. 9 digits in a second)}$$

Resolution:

$$\pm (2 \times \text{LSD}) \pm 1.4 \times \frac{\text{Trigger Error}}{\text{Gate Time}} \times \text{FREQ.}$$

Accuracy: \pm (Resolution) \pm (Time Base Error) \times FREQ.**PERIOD A****Range:** 10 ns to 10⁷ s.**LSD displayed:**

$$\frac{1 \text{ ns}}{\text{Gate Time}} \times \text{PER. (e.g. 9 digits in a second)}$$

Period average: User selects MEAN function, and n = 100, or n = 1,000.**Time Interval A—B****Range:** 0 ns to 10⁷ s.**LSD Displayed:** 1 ns (100 ps using MEAN)**Resolution:** $\pm (2 \times \text{LSD}) \pm (\text{START Trigger Error}) \pm (\text{STOP Trigger Error})$ **Accuracy:** \pm (Resolution) \pm (Time Base Error) \times TI \pm (Trigger Level Error) \pm (2 ns)**Gate mode:** MIN only.**Time interval average:** User selects MEAN function, and n = 100, or n = 1,000**Time Interval Delay (Holdoff)**Front panel Gate Adjust control inserts a variable delay between START and enabling of STOP. Electrical inputs during delay are ignored. Delay ranges are same as gate time ranges (100 μ s, to 4s NOMINAL) for gate modes of Fast, Norm, and Manual.**Inverse Time Interval A—B****Range:** 10⁻¹⁰ to 10⁹ units/second

LSD Displayed, Resolution, and Accuracy are inverse of Time Interval A—B specifications.

Rise and Fall Time A**Range:** 20 ns to 10 ms transition with 50 Hz to 25 MHz repetition rates (50% duty cycle).**Minimum pulse height:** 500 mV peak-to-peak.**Minimum pulse width:** 20 ns.**Duty cycle range:** 20% to 80%.

LSD Displayed and Resolution are same as Time Interval A—B Specifications.

Pulse Width A**Range:** 5 ns to 10⁷ s.**Trigger point range:** 40% to 60% of pulse height.

LSD Displayed and Resolution are same as Time Interval A—B specifications.

Duty Cycle A**Range:** 1% to 99%, 0 to 100 MHz.**Trigger point range:** 40% to 60% of pulse height.

$$\text{LSD Displayed: } \frac{1 \text{ ns}}{\text{PER}} \times 100\%$$

NOTE: Constant duty cycle required during measurement.

Slew Rate A**Range:** 50 V/s to 10⁸ V/s slew rate with 50 Hz to 25 MHz repetition rates (50% duty cycle). Minimum Pulse Height, Width, and Duty Cycle Range are same as Rise and Fall Time A.**Input mode:** Automatically set to COMMON A with 10% and 90% trigger levels.**Ratio A/B****Range:** Channel A, 0 to 200 MHz (prescaled by 2).
Channel B, 0 to 100 MHz

$$\text{LSD Displayed: } \frac{\text{RATIO}}{\text{FREQ} \times \text{Gate Time}} \quad \text{where FREQ is higher frequency after prescaling.}$$

Totalize A**Range:** 0 to 100 MHz.**LSD Displayed:** 1 count of input**HP-IB Output:** At end of gate.**Manual:****Count reset:** Via RESET key.**HP-IB output:** Totalize data on-the-fly sent if cycle mode set to Single. Input frequency range in this mode is 0 to 50 Hz nominal.**Gated:****Count reset:** Automatic after measurement.**PHASE A REL B****Range:** -180° to 360°, Range Hold off, or 0° to 360°, Range Hold on, with signal repetition rates of 30 Hz to 1 MHz.**Minimum signal:** 100 mV rms.**LSD Displayed:** 0.1°**Gate Time****Range:** 100 ns to 10⁷ s.**LSD Displayed:** Up to three digits with Ext. Arm Enable OFF, 100 ns when ON. MIN Gate Mode display zero.

Trigger Level

Range: X1, +5 to -5 volts; X10, +50 to -50 volts.

Resolution: X1, 10 mV; X10, 100 mV.

Accuracy (X1): ±20 mV, ±0.5% of reading

Time Base

Standard crystal:

Frequency: 10 MHz

Aging rate: < 3 × 10⁻⁷/month.

Temperature: < 4 × 10⁻⁶, 0 to 50°C.

Line voltage: < 1 × 10⁻⁷ for 10% change.

High stability crystal: See Option 010.

External time base input: Rear panel BNC accepts 5 or 10 MHz, 200 mV rms into 1 kΩ; 5V rms maximum

Time base out: 10 MHz, >1V p-p into 50Ω via rear panel.

Statistics

Sample size: Selectable between either n = 100 or n = 1,000 samples.

Std. dev.: Displays a standard deviation of selected sample size.

Mean: Displays mean estimate of selected sample size.

Smooth: Performs a weighted running average and truncates unstable least significant digits from display.

Math

All measurement functions, with exception of GATE TIME and TRIG LVL, may be operated upon by Math functions. Offset, Normalize, and Scale may be used independently or together as follows:

$$\text{Display} = \frac{\text{Measurement} + \text{Offset}}{\text{Normalize}} \times \text{Scale}$$

Number value range: ±1 × 10⁻⁹ to ±9 × 10⁹

Last display: Causes value of previous display to Offset (negative value), Normalize, or Scale all subsequent measurements.

Measurement t-l: Causes each new measurement to be Offset (negative value), Normalized, or Scaled by each immediately preceding measurement.

Hewlett-Packard Interface Bus

Programmable controls: All measurement functions, Math, Statistics, Reset, Range Hold, Ext. Arm Enable/Slope, Check, Gate Adj. (~ 1 ms to 1 s), Gate Open/Close (gate times to ∞), Gate Mode Cycle, Preset, Slope, Common A, Auto Trigger.

Special functions: **FREQ B, PULSE B, TIME B**→A, **TOT A**→B, **LEARN, MIN, MAX**, all internal diagnostic routines.

HP-IB commands: Trigger, Clear, Remote, Local, Local Lockout, Require Service.

Data output: Fixed output format consisting of 19 characters plus CR and LF output is typically 8 ms.

Option 040: adds complete systems programmability; see column at right.

General

Gate: Minimum, manual, or continuously variable (NORM/FAST) via Gate Adj. control

NORM: 20 ms to 4 s NOMINAL.

FAST: 100 μs to 20 ms NOMINAL.

MIN: Minimum gate time. Actual time depends on function.

MANUAL: Each press opens or closes gate.

Cycle: Determines delay between measurements.

NORM: No more than 4 readings per second, nominal.

MIN: Updates display as rapidly as possible (~ 15 readings per second, depending on function).

SINGLE: One measurement taken with each press of button.

Arming: Ext. Arm Enable key allows rear panel input to determine Start and/or Stop point of a measurement. External gate defined by both Start and Stop armed. All measurements are armable except Manual Totalize, Phase, and Trigger Level.

Start arm: + or - slope of arm input signal starts measurement.

Stop arm: + or - slope of arm input signal stops measurement. When used, Start Arm must occur before Stop Arm.

Ext. arm input: Rear panel BNC accepts TTL into 20 kΩ. Minimum Start To Stop Time: 200 ns.

Trigger level out: DC output into 1 MΩ via rear panel BNC's for Channel A and B; not adjusted for attenuators.

Accuracy at DC (X1): ±15mV ±0.5% of TRIG LVL reading.

Gate out: TTL level into 50Ω; goes low when gate open; rear panel BNC.

Range hold: Freezes decimal point and exponent of display.

Reset: Starts a new measurement cycle when pressed.

Check: Performs internal self test and lamp test.

Display: 12-digit LED display in engineering format; exponent range of +18 to -18.

Operating temperature: 0 to 50°C.

Power requirements: 100, 120, 220, 240 VAC (+5%, -10%), 48-66 Hz; 130 VA max.

Weight: Net, 8.8 kg (19 lbs. 8 oz.); shipping, 13.6 kg (30 lbs.)

Dimensions: 425.5 mm W × 132.6 mm H × 345.4 mm D (16¾" x 5¼" x 13½"), not including removable handles.

Options

Option 010: High Stability Time Base (Oven)

Frequency: 10 MHz.

Aging rate: < 5 × 10⁻¹⁰/day after 24 hour warm up.

Short term: < 1 × 10⁻¹⁰ rms for 1s average.

Temperature: < 7 × 10⁻⁹, 0 to 50°C

Line voltage: < 1 × 10⁻¹⁰ for 10% change.

Warm-up: Within 5 × 10⁻⁹ of final value in 20 minutes.

Option 020: DC Digital Voltmeter

Range: 4 digits, autoranging, autopolarity, in ±10, ±100, ±1000 V ranges.

Sensitivity: 100 μV, 1 mV, 10 mV, 100 mV for ±1V, ±10 V, ±100 V, ±1000 V readings.

LSD Displayed: Same as sensitivity.

Input type: Floating pair

Input impedance: 10 MΩ ± 1%

Option 030: 1.3 GHz C Channel

Input Characteristics

Range: 150 MHz to 1.3 GHz

Sensitivity: 10 mV rms sinewave (-27 dBm) to 1 GHz. 100 mV rms sinewave (-7 dBm) to 1.3 GHz.

Frequency C

Range: 150 MHz to 1.3 GHz, prescaled by 20. LSD Displayed, Resolution, and Accuracy are same as Frequency A.

Ratio C/A

Range: Channel A, 0 to 200 MHz

Channel C, 150 to 1300 MHz.

Option 040: Complete Systems Programmability

Adds remote selection of low pass filter, AC/DC coupling, X1-X10 attenuation, DC trigger level and input impedance for both Channel A and B.

Definitions

Duty cycle: Percentage of time a signal is high or low, depending on Slope A setting. Trigger point is high/low dividing point.

$$\text{DUTY CY} = \frac{\text{PULSE}}{\text{PER}} \times 100\%$$

Slew rate: Effective slope between 10% and 90% points of rising or falling signal depending on Slope A setting.

$$\text{SLEW} = \frac{V_B - V_A}{T_I}$$

Phase: Angle, with respect to B signal, between 50% points of channel A and B signals, trigger slopes selected by Channel A and B slope switches.

$$\text{PHASE} = (T_{I1} + T_{I2}) \div \frac{2}{\text{PER}} \times 360^\circ,$$

T_{I1} is time between 50% points of A then B signals using slopes defined during Phase measurement.

T_{I2} is time between 50% points of A then B signals using complement slopes to T_{I1}.

Front handles: supplied with instrument.

Ordering Information

Option 010: Oven Oscillator

Option 020: DVM

Option 030: C Channel

Option 040: Expanded HP-IB Control

Option 908: Rack Flange Kit for use without handles

Option 913: Rack Flange Kit for use with supplied front handles

Price

add \$725

add \$350

add \$500

add \$700

add \$25

add \$31

5335A Universal Counter

\$3350

ELECTRONIC COUNTERS

100 MHz Universal Counter

Model 5328A

- 100 MHz, 512 MHz and 1300 MHz
- 100 ns or 10 ns time interval
- T.I. averaging to 10 ps resolution
- "Armed" measurements
- DVM options
- HP-IB interface option

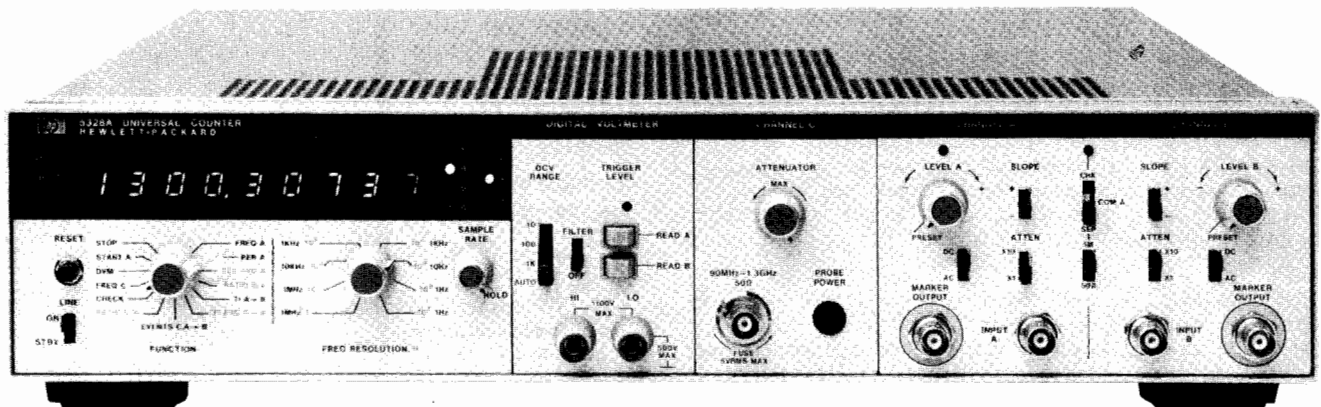

5328A with Opt 021,031,041



Description

The 5328A, thru the use of technology such as a ROM controlled measurement cycle and a modular design, provides you with excellent universal counter price/performance. Optional modules allow you to tailor the performance of the 5328A to meet your particular measurement needs. In many instances, however, the standard 5328A offers all the capability you're likely to need.

Burst and CW measurements to 100 MHz: special gating circuits start a measurement only when the input signal is present, allowing burst frequencies to be measured as easily as CW signals. The option 030 channel C extends this capability to 512 MHz; option 031, to 1300 MHz.

Single shot time interval measurements: the standard universal module's 100 ns single shot resolution meets or exceeds the requirements for a wide range of applications such as mechanical and electromechanical device timing (relays), time of flight measurements (ballistics), sonar ranging, radio ranging and navigation

Time interval averaging: resolution better than 10 ps (10^{-11} seconds) for repetitive time intervals as short as 100 ps.

Period, period average, ratio, totalize, scale: extra problem solving power for your special requirements.

Armed measurements: versatile arming modes (controlled by a rear panel switch) allow real time control over when a measurement begins. Useful for measurements such as frequency burst profile and frequency sweep linearity.

Trigger lights: trigger light blinks when channel is triggering; light is ON when input is above trigger level; OFF when input is below trigger level. Simplifies trigger level adjustments

High performance marker outputs: marker outputs (operational to 100 MHz) indicate where channel is triggering in real time for oscilloscope monitoring applications. Provides measurement feedback to the operator for greatly simplified measurement set-ups.

These features and capabilities make the 5328A an excellent choice for general purpose lab use, electronic service, and production test. For more demanding applications, a variety of options offer extended performance at a modest increase in price.

Summary of Characteristics

Model No.	Description	Features	Note
5328A	Universal Counter	Frequency to 100 MHz; 100 ns single shot T.I.; T.I. averaging; Period; Period Avg; ratio; totalize	
Opt. 010	High Stability Time Base	Oven oscillator with aging rate $< 5 \times 10^{-10}$ /day	
Opt. 011	HP-IB Interface	Allows 5328A to output data and be controlled via the HP Interface Bus.	
Opt. 020	DVM	Single ended DVM for trigger level and external voltage measurements	
Opt. 021	High Performance DVM	Floating DVM for trigger level and high accuracy external voltage measurements.	
Opt. 030	512 MHz Channel C	Frequency measurements to 512 MHz; 9 digit display.	
Opt. 031	1300 MHz Channel C	Frequency measurements to 1300 MHz; 9 digit display.	
Opt. 040	High Performance Universal Module	Same as standard 5328A but with 10 ns single shot T.I.; improved T.I. averaging; improved T.I. accuracy; measurements with delay; T.I.A--B marker; hysteresis compensation; switchable input impedance (1 M Ω /50 Ω).	
Opt. 041	Programmable Input Module	Full remote programming of all universal module controls thru opt. 011; 10 ns single shot T.I.; switchable 1 M Ω /50 Ω input impedance.	Opt. 011 Required for HP-IB use



5328A Option Descriptions

High Stability Time Base (Opt 010)

The standard time base for the 5328A is a room temperature 10 MHz crystal providing a long term aging rate of less than 3 parts in 10^7 per month. The option 010 oven oscillator offers excellent short term and temperature stability which can contribute to higher measurement accuracy. The low aging rate of $<5 \times 10^{-10}$ /day permits longer intervals between time base calibrations.

HP Interface Bus for Systems Use (Opt 011)

The option 011 HP-IB Interface brings the full capability and power of the HP Interface Bus. The 5328A can accept program code words over the HP-IB which remotely program various front and rear panel controls. In addition, measurement results may be output over the bus to HP-IB compatible instruments, calculators, or computers.

Remotely programmable controls include FUNCTION selection, RESOLUTION selection, ARMING, SAMPLE RATE (max. or manual), RESET, measurement modes, output modes, and display modes. Option 041 adds programming of channel A and B input signal conditioning controls.

Digital Voltmeters (Opt 020, 021)

The unique combination of an integrating digital voltmeter with a universal counter produces a superb general purpose measuring instrument. By using a voltage-to-frequency conversion technique, the incremental cost of adding DVM capability to the 5328A is very low.

Two DVM options are available; the option 020 DVM with single-ended input and the option 021 High Performance DVM with floating input. You can use these DVMs to measure channel A and B trigger levels and external voltages. Since a built-in DVM greatly simplifies time interval measurement set-ups, it is highly recommended that one of the DVM options be selected, particularly if time interval measurements are one of your major applications.

High Frequency Channel C (Opt 030, 031)

With a high frequency channel C module the 5328 is ideally suited for use in a wide variety of communications measurements. Option 030 gives direct count measurements to 512 MHz with 15 mV rms sensitivity; option 031 counts to a full 1300 MHz with 20 mV rms sensitivity. Typical applications include servicing, maintaining, calibrating, and monitoring communications transmitters and receivers such as found in two-way radio, radio and television broadcasting, mobile radio, and common carrier multiplexing and transmission.

Extended Capability Universal Modules (Opt 040, 041)

Options 040 and 041 give extended performance for time interval measurements. Option 040 is designed for bench use and includes "delay" capability for increased measurement versatility. Option 041 adds full programming of the input signal conditioning controls.

Both of these options generate a 100 MHz clock to give 10 ns single shot resolution for time interval measurements. This resolution is useful in applications such as computer/peripheral timing measurements, logic timing measurements, radar ranging, and optical ranging.

For improved time interval averaging performance, the options have input channels adjusted for delay matching to better than 2 ns. Additionally, options 040 and 041 use a jittered clock in T.I. AVG. function to give averaging even for those cases when the input repetition rate is synchronous with the counter's internal time base.

Selectable input impedance adapts the counter to the measurement environment: 50Ω for fast signals in a 50Ω environment, 1 MΩ to reduce circuit loading or to use with scope probes.

The "delay" feature of option 040 allows you to disable the inputs from triggering for selected periods of time (20 μs to 20 ms). Delay is useful for ignoring high amplitude noise such as from chattering relays or ignoring stop pulses in multiple stop T.I. measurements.

Option 041 allows remote programming of input trigger level, slope, coupling, and attenuator setting. Under remote control, the input impedance is independently selectable on the A and B channels. Also, a remote "Invert" function switches the A and B channel signals internally. "Invert" gives exceptional flexibility for two channel time interval measurements.

Measurements with Delay (Opt 040)

Delay mode is activated by the inner concentric knob on Level A control of option 040 Universal Module. A red LED indicates delay is activated. In delay mode, Channel A triggers and is then disabled from triggering again until the delay times out (disabled state occurs within 1 μs after triggering.) Channel B is continuously disabled until the delay times out. After the delay, both A and B are enabled. The delay time may be measured by placing the counter in T.I.A→B and the Universal Module in check (CHK).

Delay range: 20 μs to 20 ms continuously adjustable.

Minimum dead time: 1 μs between stop and next start (T.I. average measurements only).

General

Display: 9 digit LED display, ninth digit used only with channel C functions (FREQ. C, Ratio C/A, Events C, A→B).

Blanking: suppresses display of unwanted zeros to left of most significant digit.

Storage: holds reading between samples; can be overridden by rear panel switch.

Sample rate: variable from less than 2 ms between measurements to HOLD which holds display indefinitely.

Gate output: rear panel output, TTL levels; high when counter gate open.

Time base output: rear panel output: TTL levels.

Check signal: with function switch in CHECK, counter should display 10 MHz ± 1 count. With options 040 and 041, place function switch in FREQ A and universal module in CHECK (CHK). Counter should display 100 MHz ± 1 count.

Operating temperature: 0° to 50° C.

Power requirements: 100/120/220/240 V rms, +5%, -10% (switch selectable), 48-66 Hz; 150 VA max.

Time Base Oscillators

Standard Crystal Oscillator

Frequency: 10 MHz.

Aging rate: $<3 \times 10^{-7}$ /month.

Temperature: $\pm 2.5 \times 10^{-6}$, 0° to 50° C.

Line voltage: $<1 \times 10^{-7}$ for 10% change.

Opt 010 Oven Oscillator

Frequency: 10 MHz.

Aging rate: $<5 \times 10^{-10}$ /day after 24-hour warm-up.

Short term: $<1 \times 10^{-10}$ rms/s.

Temperature: $<7 \times 10^{-8}$, 0° to 50° C.

Line voltage: $\pm 5 \times 10^{-9}$ for 10% variation.

Warm-up: within 5×10^{-9} of final value in 20 min.

Ext. freq. std. input: 30 kHz to 10 MHz signal of amplitude >1.0 V rms into 1 kΩ. Maximum input: 5 V p-p. With options 040 and 041 the following constraints apply: ext. freq. std. must be 10 MHz for Period Avg., T.I. Avg., Period (N = 1), and T.I. (N = 1).

HP-IB Interface (Opt 011)

Option 011 provides digital output of measurement data ("talker") as well as input for remote program control ("listener"). HP-IB cable not supplied.

Programmable features: function, resolution, sample rate (max or manual control), arming, display modes, measurement cycle modes, output modes, and reset commands. Option 041 adds control of channel A and B trigger level, slope, attenuator, coupling, input impedance, and SEP-COM-CHECK selection.

HP-IB commands: responds to the following bus commands (see HP-IB Users Guides for definitions)—Unlisten, Untalk, Local Lockout, Device Clear, Serial Poll Enable, Serial Poll Disable, Go to Local, Selected Device Clear, and Group Execute Trigger.

Service request (SRQ): if enabled, indicates end of measurement.

Maximum data output rate: 500 readings/sec.

Accessories

5363B Time Interval Probes: solve many of the "hidden" problems of precision time interval measurements. The 5363B Time Interval Probes minimize circuit loading, give calibrated trigger level settings, increase input dynamic range, and allow differential channel delay calibration.

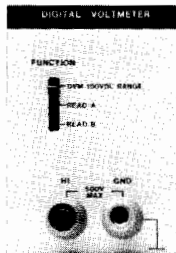
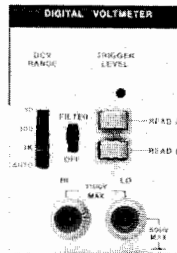
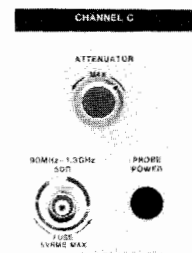
Opt 020
DVMOpt 021
High Performance DVMOpt 030
512 MHz
Channel COpt 031 1300 MHz
Channel C

Accessories

10855A Preamp: (for use with Opt 031): gives >22 dB gain with ± 1 dB flatness over the entire frequency range of the Opt 031 1300 MHz Channel C.

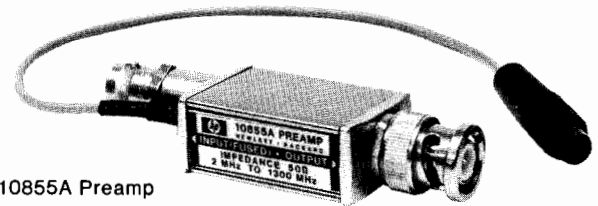

10855A Preamp

Digital Voltmeter Modules

Digital Voltmeter Measurements†

DVM (Opt 020 and 021): trigger levels of input channels A and B and external voltages may be measured.

Maximum sensitivity	Opt 020	Opt 021
Meas. time:		
10 s ($N = 10^3$)	1 mV	10 μ V
1 s ($N = 10^2$)	1 mV	100 μ V
0.1 s ($N = 10^1$)	2 mV	1 mV
10 ms ($N = 10^0$)	20 mV	10 mV
1 ms ($N = 10^{-1}$)	200 mV	100 mV
Range	0 to ± 125 V dc	± 10 , ± 100 , ± 1000 V dc, and Autorange
Accuracy (20 min. warm-up)	$\pm 0.5\%$ reading ± 4 mV	$\pm 0.03\%$ reading $\pm 0.004\%$ range; for 1000 V range: $\pm 0.087\%$ reading $\pm 0.004\%$ range
Input terminals	Single ended	Floating pair
Input impedance	10 M Ω	10 M Ω
Normal mode rejection ratio	>60 dB at 60 Hz (50 Hz) $\pm 0.1\%$	>80 dB at 50 Hz or greater with filter on
Effective common mode rejection ratio (1 k Ω unbalance)		DC: >120 dB AC: >120 dB for multiples of 60 Hz (50 Hz) with filter on
Maximum input	± 500 V	HI to LO: ± 1100 V all ranges; LO to chassis ground: ± 500 V
Trigger level measurements	2 mV display resolution	1 mV display resolution; trigger level reading automatically multiplied by setting of attenuator switch if using Opt 040 or 041 universal modules

†Performance: 60 days at 23°C $\pm 5^\circ$ C and RH <80%

Channel C Modules

Input characteristics	Opt 030	Opt 031
Sensitivity	15 mV rms	20 mV rms
Coupling	dc	ac
Trigger level	0 V, fixed	0 V, fixed
Impedance	50 Ω	50 Ω
Maximum input	5 V rms	5 V rms, ± 5 V dc
Input protection	fused	fused
Attenuator	No	Variable for optimum noise suppression on signals to 5 V rms

Frequency C measurements

Range	Opt 030	Opt 031
Range	5-512 MHz (direct count)	90-1300 MHz (prescaled, $\times 4$)
Resolution	1 MHz to 0.1 Hz in decade steps	1 MHz to 0.1 Hz in decade steps
Accuracy	± 1 count \pm time base error	± 1 count \pm time base error

Ratio C/A measurement

Range: A C	Opt 030	Opt 031
	0-10 MHz 5-512 MHz	0-10 MHz 90-1300 MHz

General

Probe power	Opt 030	Opt 031
	No	Power to operate 10855A Preamp or HP active probe

Events C, A to B (with Opt 030 only)

The number of events at the C input are totaled during the synchronized time interval defined by inputs to channels A and B. The synchronized time interval is a multiple of 100 ns with the standard universal module; a multiple of 10 ns with Opt 040 or 041 universal modules.

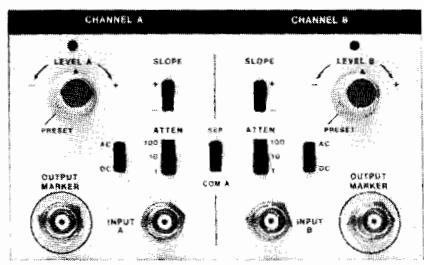

Standard
Universal Module

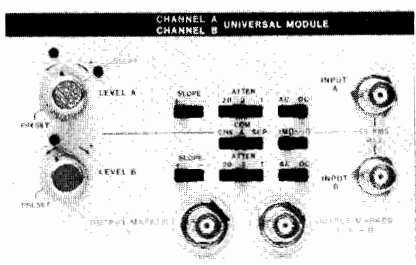

Opt 040
High Performance
Universal Module

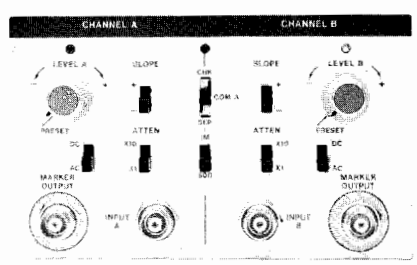

Opt 041
Programmable Input
Universal Module

Universal Modules, Channels A and B

Input characteristics	Standard	Opt 040, Opt 041
Sensitivity: 0-40 MHz (dc coupled) 20 Hz-40 MHz (ac coupled) 40-100 MHz	25 mV rms 25 mV rms 50 mV rms	25 mV rms 25 mV rms 50 mV rms
Min pulse width	5 ns, 140 mV p-p	
Coupling	ac or dc, switchable	
Impedance	1 MΩ, 40 pF shunt	1 MΩ or 500Ω, switchable
Trigger level	variable ± 2.5 V times atten. setting	
Trigger slope	independent selection of + or - slope	
Attenuators	X1, X10, X100	Opt 040: X1, X2, X20 Opt 041: X1, X10
Dynamic range	25 mV to 1 V rms times attenuator setting for 0-40 MHz; 50 mV to 500 mV times attenuator setting for 40-100 MHz	
Channel input	Separate or Common A	Separate, Common A, or Check
Delay	No	Opt 040 only: 20μs to 20 ms
Programmable Controls	No	Opt 041 only: level, slope, coupling, atten, impedance, SEP-COM-CHK

Frequency A measurement

Range	0-100 MHz, direct count
Resolution	1 MHz to 0.1 MHz in decade steps

Period A measurement

Range	0-10 MHz
Resolution	100 ns to 1 s in decade steps 10 ns to 0.1 s in decade steps

Period Average A measurements

Range	0-10 MHz
Resolution	100 ns to 0.01 ps in decade steps 10 ns to 0.01 ps in decade steps

Time interval A to B measurements

Range	100 ns to 10 ⁶ s	10 ns to 10 ⁷ s
Resolution	100 ns to 1 s in decade steps	10 ns to 0.1 s in decade steps

Time interval average A to B

Range	0.1 ns to 10 s	0.1 ns to 1 s
Resolution	±100 ns ± trigger error √N ± 10 ps	±10 ns ± trigger error √N ± 10 ps
Min. pulse width	25 ns	10 ns
Min. dead time (from each stop event to next start event)	150 ns	40 ns

Ratio B/A measurement

Range: A B	0-10 MHz 0-100 MHz
Totalizing and scaling, Start A The number of counts at the A input are totalized for N = 1 on the resolution switch. For N > 1, A/N is totalized and the scaled output (A/N) is available at the Time Base Out rear panel connector.	
Range: N = 1 N > 1	0-100 MHz 0-10 MHz

Front Handles: supplied with instrument

Options and Accessories	Price
010: High Stability Time Base	\$725
011: HP-IB Interface	\$350
020: DVM	\$275
021: High Performance DVM	\$675
030: 512 MHz Channel C	\$525
031: 1300 MHz Channel C	\$725
040: High Performance Universal Module	\$350
041: Programmable Input Controls Module (Requires Option 011 for HPIB use)	\$950
908: Rack Flange Kit for use w/o front handles	\$20
913: Rack Flange Kit for use with supplied front handles	\$20
10855A Preamp	\$375
5363B Time Interval Probes	\$3250

5328A Universal Counter \$1725

338



ELECTRONIC COUNTERS

Universal Counters

Models 5315A/B, 5316A

- Frequency, Period, Ratio, and Totalize to 100 MHz
- Three Versions: Portable, Rackable, or HPIB

- Uses Reciprocal Technique for Full Low-frequency Resolution
- 100 ns Time Interval, 10 ps T.I. Averaging

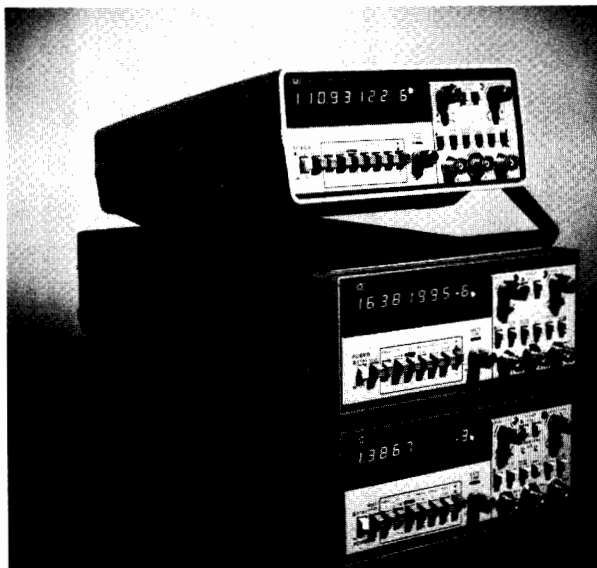

A Quiet Revolution in Capability . . .

HP's economical 5315A/B, and 5316A counters provide all the universal counter capability you've come to expect at much higher prices. That's because they use a unique custom circuit called the MRC (Multiple Register Counter) which packs counting and computing power into this popular counter series. To a user, the differences in operation from conventional direct models can be listed quickly: operation is by push-button rather than dials and knobs, low frequency resolution is an outstanding 7 digits per second of gate time, and reliability is extremely good due to the counter's low chip count.

Much of the counter's performance is based on reciprocal counting techniques first pioneered in HP's high-performance 5360A computing counter, and the current model 5345A Universal Counter. The use of these techniques coupled with HP's MRC and a microprocessor provide a quiet but powerful revolution in counter performance within the 5315A/B and 5316A. For example, this counter gives you its full 7-digits/second resolution over the following range: 1 Hz to 100 MHz. Think of it: seven digits of resolution at 1 Hz, in one second of gate time. That, simply stated, shows the power of the MRC and reciprocal counting.

High Performance, Low Price

In addition to its economy, the MRC counter offers a full set of universal counter measurements, and there are very few limitations to this capability.

Frequency to 100 MHz, C-Channel to 1.0 GHz

The basic MRC counter measures frequency to 100 MHz. Additionally the optional C-Channel measures to 1.0 GHz for both CW and pulsed RF signals as narrow as 60 ms. The C-Channel option is particularly useful in navigation and communications equipment testing due to this pulsed RF measurement feature.

Time Interval to 100 ns, T.I. Averaging to 10 ps

The MRC counter provides three time measurement modes. Single-shot time interval allows measurements over a range of 100 ns to 100,000 seconds. This capability can be used to measure pulse width. Time interval averaging provides greater resolution for repetitive events. Finally, time interval delay avoids measurement of spurious signals by holding off the counter's trigger point by a precise, operator-selectable amount of time.

A Full Set of Measurements

Besides the frequency and time functions mentioned above, the MRC counter has other measurement functions that make it a truly impressive value:

Period A—allows single period measurements via Channel A.

Ratio A/B—allows frequencies to 100 MHz into both Channel A and B

A By B—provides the gated totalize function of A gated by B

Totalize—a manually gated totalize mode of operation

Input Signal Conditioning

A full complement of input signal conditioning controls are provided for both channels. These include \pm slope, ± 2.5 VDC trigger level, and AC/DC coupling. Other controls are a Separate/Common switch, and a 100 KHz low-pass filter for Channel A.

A Choice of Three Models

The MRC counter is available in three different versions:
5315A: A portable, light-weight unit best suited for field applications. This unit has a convenient carrying handle and optional battery power is available for up to 4 hours continuous operation. Despite its high impact plastic case, the 5315A possesses low RFI/EMC characteristics making it equally suitable for bench use.



5315B: A rackable, stackable counter that is designed to meet the most demanding RFI/EMC specs, the 5315B is intended primarily for rack mount use. This model has an optional Offset-Normalize (006) module that mathematically modifies the counter's display and so provides readouts directly in engineering units of the user's choice. The 5315B Option 006 is also rackable and stackable.

5315A/B 5316A Specifications

Input Characteristics (Channel A and Channel B)

Range: DC coupled 0 to 100 MHz.

AC coupled 30 Hz to 100 MHz.

Sensitivity: 10 mV rms sine wave to 10 MHz.

25 mV rms sine wave to 100 MHz.

75 mV peak-to-peak pulse at minimum pulse width of 5 ns.

Sensitivity can be varied continuously up to 500 mV rms *NOMINALLY* by adjusting sensitivity control. In sensitivity mode, trigger level is automatically set to 0 V *NOMINAL*.

Dynamic range:

30 mV to 5 V peak-to-peak, 0 to 10 MHz.

75 mV to 5 V peak-to-peak, 10 to 100 MHz.

Coupling: AC or DC, switchable.

Filter: Low pass, switchable in or out of Channel A. 3 dB point of *NOMINALLY* 100 kHz.

Impedance: 1 MΩ *NOMINAL* shunted by less than 40 pf.

500 KΩ *NOMINAL* shunted by less than 70 pf (COMMON A).

Signal operating range: +2.5 Vdc to -2.5 Vdc.

Attenuator: X1 or X20 *NOMINAL*.

Trigger level: Variable between +2.5 Vdc and -2.5 Vdc.

Slope: Independent selection of + or - slope.

Channel input: SEPARATE or COMMON A.

Damage level:

AC & DC x 1:

DC to 2.4 kHz 250 V (DC + AC rms)

2.4 kHz to 100 kHz 6×10^5 V rms Hz/FREQ

> 100 kHz 6 V rms

AC & DC x 20:

DC to 28 kHz 500 V (DC + AC peak)

28 kHz to 100 kHz 1×10^7 V rms Hz/FREQ

> 100 kHz 100 V rms

Frequency (Channel A)

Range: .1 Hz to 100 MHz (burst or CW).

LSD displayed: 10 Hz to 1 n Hz depending upon gate time and input signal. At least 7 digits displayed per second of gate time.

Period

Range: 10 ns to 10^5 s.

LSD displayed: 100 ns to 1 fs depending upon gate time and input signal. At least 7 digits displayed per second of gate time.

Time Interval

Range: 100 ns to 10^5 s.

LSD displayed: 100 ns.

Time Interval Average

Range: 0 ns to 10^5 s.

LSD displayed: 100 ns to 10 ps depending upon gate time and input signal. See table in definitions section.

Number of intervals averaged (N): $N = \text{Gate Time} \times \text{FREQ}$.

Minimum dead time (stop to start): 200 ns.

Time Interval Delay (Holdoff)

Front panel gate time knob inserts a variable delay of *NOMINALLY* 500 μs to 20 ms between START (Channel A) and enabling of STOP (Channel B). Electrical inputs during delay time are ignored. Delay time may be digitally measured by simultaneously pressing T.I. Averaging, T.I. Delay and blue key. Other specifications of T.I. Delay are identical to Time Interval.

5316A: This model possesses all the characteristics of both the 5315A and 5315B, and it has HP-IB capability built-in as standard equipment. It has low RFI, it is rackable, and it is functionally identical to the 5315A/B. In addition to programmable measurement functions, the user can also select DC trigger level and ± slope under HP-IB control. Channel A and B trigger levels are brought out to the front panel on this unit for easy measurement with a DVM.

Ratio

Range: 0.1 Hz to 100 MHz, both channels

LSD: $\frac{2.5 \times \text{Period A}}{\text{Gate Time}} \times \text{Ratio}$. (rounded to nearest decade)

Totalize

Manual:

Range: 0 to 100 MHz.

A gated by B:

Totalizes input A between two events of B. Instrument must be reset to make new measurement. Gate opens on A slope, closes on B slope.

Range: 0 to 100 MHz.

General

Check: Counts internal 10 MHz reference frequency over gate time range *NOMINALLY* 500 μs to 20 ms.

Error light: LED warning light activated if logic error is found during instrument turn-on self-check.

Display: 8 digit amber LED display, with engineering units annunciator.

Overflow: Only frequency and totalize measurements will overflow. In case of overflow, eight least significant digits will be displayed and amber front panel overflow LED will be actuated.

All other measurements which would theoretically cause a display of more than 8 digits will result in the display of the 8 most significant digits.

Gate time: Continuously variable, *NOMINALLY* from 60 ms to 10 s or 1 period of the input, whichever is longer.

Sample rate: Up to 5 readings per second *NOMINAL* except in time interval mode, where it is continuously variable *NOMINALLY* from 250 ms to 10 s via Gate Time Control.

Operating temperature: 0° to 50°C.

Power requirements: 100, 120, 220, 240 V (+5%, -10%) 48-66 Hz; 15 VA maximum

Weight: Net, 2.2 Kg (4 lbs. 12 oz.); shipping, 4.1 Kg (9 lbs).

Dimensions: 238 mm W x 98 mm H x 276 mm D (9 3/8 x 3 3/8 x 10 3/4 in.)

Time base:

Frequency: 10 MHz.

Aging rate: < 3 parts in 10^7 /mo.

Temperature: ≤ 5 parts in 10^6 , 0 to 50°C.

Line voltage: ≤ 1 part in 10^7 for ± 10% variation.

Additional 5315B Specifications

Rack and stack metal case with rear panel, switchable AC power line module. Specifications same as 5315A except as follows:

Rack mount: 5315B is recommended for rack mounting via Rack Mount Kit 5061-0072.

Oscillator output: 10 MHz, 50 mV pk-pk into 50 Ω load, on rear panel.

External frequency standard input: 10 MHz, 1 V RMS into 500 Ω, on rear panel. Not available with option 001.

Dimensions: 212 mm W x 88 mm H x 345 mm D (8 3/8 x 3 1/2 x 13 3/4 in.)

Weight: Net, 3.2 Kg (7 lbs. 2 oz.); shipping, 4.5 Kg (10 lbs.).



ELECTRONIC COUNTERS

Universal Counters

Models 5315A/B, 5316A (Cont.)

HP-IB (5316A Only)

Data Output

Format: (alpha character) ± (Reading) (Exponent) ± (2 digits)

Data output rate: 10 Readings/Sec. Max.

Talk only mode: Selectable by rear panel switch.

Operating Commands

5316A: Reset, Initialize (to Freq. A), Wait State ON/OFF, Service Request Enabled/Disabled, Gate Time Range.

HP-IB: Group Executive Trigger, Device Clear, Selective Device Clear, Interface Clear, Local, Remote, Local Lockout, Read Status (Serial Poll Enable).

Programmable Controls and Functions

Frequency functions: Frequency A, Freq A armed by B, Totalize, A Gated by B, Ratio A/B, and Frequency C.

Period function: Period A

Time interval functions: Time A—B, Time Int. Average A—B, Time Int. Delay

Trigger level commands: Set Channel A Slope (±) Set Channel B Slope (±), A Trigger Level: ± X.XX, B Trigger Level: ± X.XX.

Gate time command: Sets Gate Time Range

Miscellaneous functions: Gate Time Check, Display Test, 10 MHz Check, Interface Test.

Additional 5316A Specifications

Rack and stack metal case with rear panel, switchable AC power line module, Specifications same as 5315A except as follows:

Rack mount kit: 5061-0072 recommended.

Oscillator output: 10 MHz, 50 mV p-p into 50 Ω load on rear panel.

External frequency standard input: 1, 5, 10 MHz, 1 V rms into 500 Ω, or rear panel.

Trigger level output: ± 5%, ± 15 mV, over ± 2.0 VDC range at front panel connectors.

Dimensions: 212 mm W × 88 mm H × 415 mm D (8 3/8 × 3 1/2 × 16 1/2 in.)

Weight: Net, 3.9kg (8 lbs. 10 oz.); Shipping, 6.3kg (14 lbs.)

Options

Opt. 001: High Stability Time Base (TCXO)

Frequency: 10 MHz.

Aging rate: < 1 part in 10⁷/mo.

Temperature: < 1 part in 10⁶, 0° to 40°C.

Line voltage: < 1 part in 10⁶ for ± 10% variation.

Opt. 002: Battery (5315A only)

Type: Rechargeable lead-acid (sealed).

Capacity: TYPICALLY 4 hours of continuous operation at 25°C.

Recharging time: TYPICALLY 16 hours to 98% of full charge, instrument non-operating. Charging circuitry included with Option. Batteries not charged during instrument operation.

Low voltage indicator: Instrument turns itself off automatically when low battery condition exists. *Discharge* LED flashes slowly when this happens. *Discharge* LED is on whenever battery is supplying power to instrument.

Charge LED indicates state of charge of battery during charging only and is on whenever battery is charged to 95% *NOMINAL* of capacity. *Charge* LED flashes when 90% *NOMINAL* of charge taken out is replaced. *Charge* LED is off if charge is less than 70% *NOMINAL* of capacity.

Line failure protection: Instrument automatically switches to battery in case of line failure.

Weight: Opt. 002 adds 1.4 Kg (3 lbs.) to weight of instrument.

Option 003: C Channel

Input Characteristics

Range: 50 to 1000 MHz, prescaled by 10.

Sensitivity: 15 mV rms sinewave (-23.5 dBm) to 650 MHz. 75 mV rms sinewave (-9.5 dBm) to 1000 MHz.

Sensitivity can be decreased continuously by up to 20 dB *NOMINAL*, 50 to 500 MHz and 10 dB *NOMINAL*, 500 to 1000 MHz by adjusting sensitivity control. Trigger level is fixed at 0 V *NOMINAL*.

Dynamic range: 15 mV to 1 V rms (36 dB), 50 to 650 MHz. 75 mV to 1 V rms (20 dB), 650 to 1000 MHz.

Signal operating range: +5 V dc to -5 V dc.

Coupling: AC

Impedance: 50 Ω *NOMINAL* (VSWR, < 2.5:1 TYPICAL).

Damage level: ± 8 V (DC + AC peak), fuse protected. Fuse located in BNC connector.

Frequency (Channel C)

Range: 50 to 1000 MHz (burst or CW).

LSD displayed: 100 Hz to 1 Hz depending upon gate time. At least 7 digits per second of gate time.

Option 004: High Stability Time Base (OVEN)

Frequency: 10 MHz

Aging rate: < 5 × 10⁻⁸/mo*

< 3 × 10⁻⁸/mo**

Temperature: 2 × 10⁻⁸, 0° to 65°C*

1 × 10⁻⁷, 0° to 65°C**

Line voltage: 1 × 10⁻⁹ for ± 10% variation

Option 006: Offset-Normalize Module

Measurements (X) operated on: Frequency, Period, Time Interval, Time Interval Delay, Ratio, and Check. Time Interval place holding zeros are not operated upon.

Modes: Normalize (X/A), Offset (X + B), Normalize and Offset ((X/A) + B); switch selectable. Dividing by zero displays zero.

A and B value selection: Entered by thumbwheel switch with 8-digit mantissa and 1-digit exponent with sign. B may be positive or negative value.

Display: 999.99999 × 10⁹ to < 1 × 10⁻⁹ range. For negative numbers, the minus sign reduces resolution by one digit.

Overflow: Frequency measurements will overflow 3 decades after which LSD will be truncated.

Rack mount kit: 5061-0074 recommended.

Weight: Option 006 adds 1.8 kg (4 lbs. 1 oz.) to instrument weight.

Dimensions:

5315B plus Option 006: 425 mm W × 88 mm H × 345 mm D (16 3/4 × 3 1/2 × 16 1/2 in.)

5316A plus Option 006: 425 mm W × 88 mm H × 415 mm D (15 3/4 × 3 1/2 × 16 1/2 in.)

Ordering Information

		5315A	5315B	5316A	Price
Option 001	High Stability Time Base (TCXO)	X	X	X	Add \$125
Option 002	Battery Pack	X			Add \$250
Option 003	C-Channel (1.0 GHz)	X			Add \$275
Option 004	High Stability Time Base (OVEN)	X	X	X	Add \$450 Add \$600
Option 006	Offset-Normalize Module		X	X	Add \$650

All 5315A orders must include one (1) of these line power options:

Option 100: 90-105 VAC

Option 120: 108-126 VAC

Option 220: 198-231 VAC

Option 240: 216-252 VAC

Price

N/C

N/C

N/C

N/C

5315A Universal Counter

\$950

5315B Universal Counter

\$1150

5316A Universal Counter

\$1700

*5315B and 5316A

**5315A

- 100 MHz
- 100 ns Time Interval
- Portable

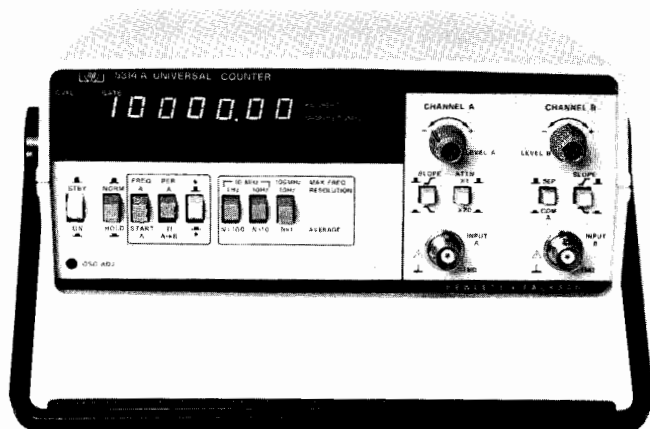

5314A

The 5314A Universal Counter is the newest result of HP's continuing low cost counter product development effort. It combines excellent performance and traditional HP quality at a very attractive price. This counter is designed to deliver reliable, high quality operation in such areas as: Production Test, Frequency Monitoring, Education, Training, Service and Calibration. Additionally, the optional battery (option 002) makes the 5314A especially attractive for field and portable applications.

Input Characteristics (Channels A and B):

Range: CHANNEL A: 10 Hz to 10 MHz Direct.

1 MHz to 100 MHz Prescaled.

CHANNEL B: 10 Hz to 2.5 MHz.

Sensitivity: CHANNEL A: 25 mv rms to 100 MHz.

75 mv peak-to-peak at minimum pulse width of 5 ns (100 MHz range).

CHANNEL B: 25 mv rms to 2.5 MHz.

75 mv peak-to-peak at minimum pulse width of 200 ns.

Coupling: AC.

Impedance: 1 MΩ NOMINAL shunted by less than 30 pf.

Attenuator: X1 or X20 NOMINAL (A channel only).

Trigger level: Continuously variable ± 350 mV times attenuator setting around average value of signal.

Slope: Independent selection of + or - slope.

Channel input: Selectable SEPARATE OR COMMON A.

Dynamic range: 75 mV p-p to 4 V p-p.

Frequency:

Range: 10 Hz to 10 MHz direct count.

10 Hz to 100 MHz prescaled by 10.

Least significant digit (LSD) displayed: Direct count 0.1 Hz, 1 Hz, 10 Hz switch selectable. Prescaled 10 Hz, 100 Hz, 1 KHz switch selectable.

Resolution: \pm LSD.

Accuracy: \pm LSD \pm (time base error) x Freq.

Period:

Range: 10 Hz to 2.5 MHz.

LSD displayed: 100 N ns for N=1 to 1000 in decade steps of N.

Resolution: \pm LSD $\pm \frac{(1.4x \text{ TRIGGER ERROR}) \times \text{Per.}}{N}$

Accuracy: \pm LSD $\pm \frac{(1.4x \text{ TRIGGER ERROR}) \times \text{Per.}}{N}$

\pm (time base error) x Per.

Time interval:

Range: 250 ns to 1 sec.

LSD Displayed: 100 ns.

Resolution: \pm LSD \pm START trigger error \pm STOP trigger error.

Accuracy: \pm LSD \pm START trigger error

\pm STOP trigger error \pm (time base error) x TI.

External arming required for START/STOP channels.

Ratio:

Range: 10 Hz to 10.0 MHz CHANNEL A.

10 Hz to 2.5 MHz CHANNEL B.

LSD Displayed: 1/N in decade steps of N for N = 1 to 1000.

Resolution: \pm LSD \pm (B trigger error x Frequency A)/N.

Accuracy: \pm LSD \pm B trigger error x Frequency A.

Totalize:

Range: 10 Hz to 10 MHz.

Resolution: \pm 1 count of input.

Totalize controlled by front panel switch.

General:

Check: Counts internal 10 MHz oscillator.

Display: 7 digit amber LED display with gate and overflow indication.

Max sample rate: 5 readings per second.

Operating temperature: 0° to 50 °C.

Power requirement: 100/120/230/240 V RMS +5%, -10%, 48-66 Hz; 10 VA max.

Weight: 2.0 kg (4.4 lb.).

Dimension: 238 mm W x 98 mm H x 276 mm D (9 $\frac{3}{8}$ x 3 $\frac{7}{8}$ x 10 $\frac{7}{8}$ in.).

Time base:

Frequency: 10 MHz.

Aging rate: < 3 part in 10⁷ per month.

Temperature: < \pm 10 parts in 10⁶, 0 to 50°C.

Line voltage: < \pm 1 part in 10⁷ for \pm 10% variation.

Options:

Option 001: High stability time base (TCXO).

Frequency: 10 MHz.

Aging rate: < 1 part in 10⁷ per month.

Temperature: < \pm 1 part in 10⁶, 0 to 40°C.

Line voltage: < \pm 1 part in 10⁸ for \pm 10% variation.

Option 002: Battery.

Type: Rechargeable lead-acid (sealed).

Capacity: Typically 8 hours of continuous operation at 25°C.

Recharging time: Typically 16 hours to 98% of full charge, instrument non-operating. Charging circuitry included with option. Batteries not charged during instrument operation.

Battery voltage sensor: Automatically shuts instrument off when low battery condition exists.

Line failure protection: Instrument automatically switches to batteries in case of line failure.

Weight: Option 002 adds typically 1.5 kg (3.3 lb.) to weight of instrument.

Definitions:

Resolution: Smallest discernible change of measurement result due to a minimum change in the input.

Accuracy: Deviation from the actual value as fixed by universally accepted standards of frequency and time.

Trigger error: (RMS)

$\sqrt{(80 \mu V)^2 + e_n^2}$ input slew rate at trigger point ($\mu V/s$).

Where e_n is the RMS noise of the input for a 100 MHz bandwidth in CHANNEL A and 10 MHz bandwidth in CHANNEL B.

Options

001 High stability time base

Price

add \$125

002 Battery

add \$100

910: Extra product manual

add \$9.50

All orders must include one (1) of these line power options:

Option 115: 86-127V

N/C

Option 230: 190-250V

N/C

5314A 100 MHz / 100 ns Universal Counter

\$475



ELECTRONIC COUNTERS

Plug-On Modular/Portable Counter System

Model 5300 A/B system & 5301A-5312A

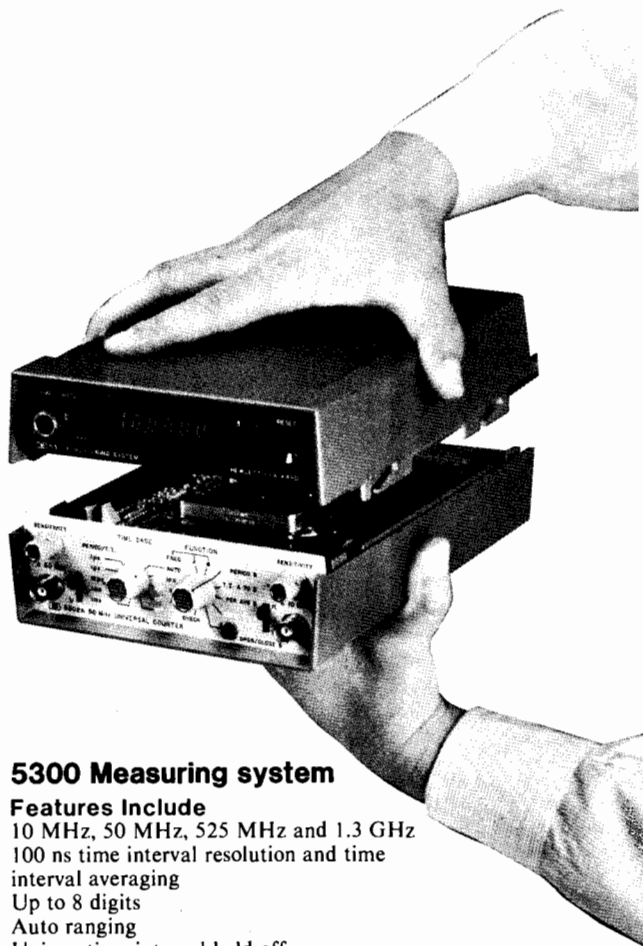

5300 Measuring system

Features Include

- 10 MHz, 50 MHz, 525 MHz and 1.3 GHz
- 100 ns time interval resolution and time interval averaging
- Up to 8 digits
- Auto ranging
- Unique time interval hold off
- Expandable with interchangeable modules
- Optional FCC type approved TCXO time base
- Portable-battery operation with all modules
- Compact and rugged
- High reliability MOS/LSI circuitry and LED display
- Designed for quick & easy owner-servicing
- Output via BCD, HP Interface Bus (HP-IB), or D to A converters

Description

Large scale integration and solid state display technology have helped to produce a uniquely versatile and capable counter at a surprisingly low cost. Easy to use and reliable, this counter does what is important—solves your measurement problems while saving your money. Versatility and antiobsolescence come from modular construction. Take your choice from two mainframes and select the snap

on module that you need now. Expand the capability later with more modules, if and when you need them.

Autoranging

Autoranging is included in many of the functions, enhancing the ease of operation by automatically selecting a correct gate time to fill the display. Any frequency within the range of the 5301A, 5302A, 5304A, 5307A and 5308A may be counted, with the counter's logic circuits automatically selecting the correct gate time (up to 1 second) for maximum resolution without exceeding the display range.

Time Interval Holdoff

Time interval holdoff is a unique feature of the 5304A Timer/Counter module. This feature allows you to add a fixed delay between the start of a time interval measurement and the enabling of the stop channel. Thus any electrical pulses or irregularities in a waveshape that occur between the desired trigger points can be ignored.

Digital and Analog Output

Digital output is available in BCD format (standard in 5300A mainframe) or ASCII format via the HP Interface Bus (to be used with 5300B mainframe) to provide interfacing with digital printers or with desktop calculators and other data processing equipment. Analog output for long term monitoring with strip chart recorders is provided by a digital-to-analog converter.

Battery Pack

A snap between battery pack provides a truly portable, light weight, go-anywhere measuring system for any of the 5300 Systems.

Serviceability

Reliability and easy servicing have been major design criteria for all of the 5300 modules. A check function is built into most of the functional modules to allow immediate checking of the basic counter circuits from the front panel. A user-oriented service support package is available that provides plug-in cards with automatic diagnostic routines that allow the 5300 mainframes to troubleshoot themselves.

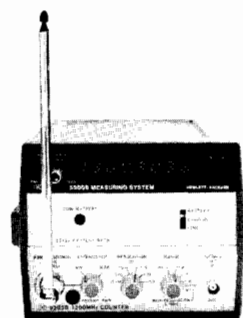

Typical Configurations

Frequency Measurement System for Mobile Communications. Go Anywhere Portability

5300B, 5310A, 5305B

Model	Frequency MHz	Period	Period Average	Time Interval	Time Interval Average	Totalize	Ratio	Multimeter ACV, DCV, Ω	High Resolution Reciprocal		
										5300A 6 DIGIT MAINFRAME	\$825 343
										5300B 8 DIGIT MAINFRAME	\$700 343
										5310A BATTERY PACK	\$375 346
										5311B DIGITAL TO ANALOG CONVERTER	\$525 346
										5312A HP-IB INTERFACE	\$475 346
5301A	10					•				\$300 344	
5302A	50	•	•	•		•	•			\$550 344	
5303B	525									\$1100 344	
5304A	10		•	•		•				\$600 344	
5305B	1300									\$1175 345	
5306A	10							•		\$900 345	
5307A	2								•	\$575 345	
5308A	75	•	•	•	•	•	•			\$700 345	

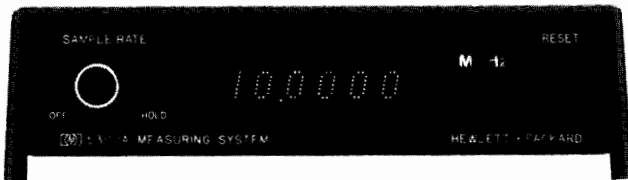

5300A

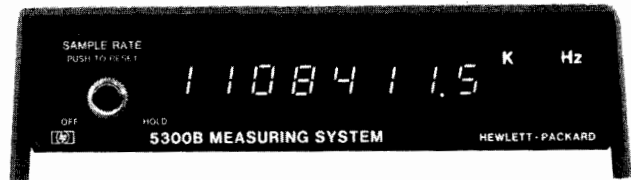

5300B



5300A and 5300B Measurement System Mainframe

The mainframe units provide the system with power, reference frequency, display, counting logic and timing control.

The 5300A has a 6-digit dot matrix display, standard time base, external time base input and BCD output as a standard rear panel output. The 5300B has an 8-digit 7-segment display, standard time base or optional TCXO time base, external time base input and no digital output from the mainframe. See mainframe/plug-on display chart below for number of display digits with a particular mainframe and plug-on combination.

Time Base

Standard crystal frequency: 10 MHz.

Stability

Aging rate: <3 parts in 10^7 /mo.

Temperature: < ± 5 parts in 10^6 , 0° to 50°C.

Typically: < ± 2 parts in 10^6 , 15° to 40°C.

Line voltage: < ± 1 part in 10^7 for 10% line variation.

Oscillator output: 10 MHz, approximately 1 V rms at rear panel BNC, 100 Ω source impedance.

External input: 1 MHz to 10 MHz, 1 V rms into 200 Ω .

Opt 001 High Stability Time Base (5300B Only)

Frequency: 10 MHz.

Stability

Aging rate: <1.2 parts in 10^6 /year.

Temperature: < ± 5 parts in 10^7 , 0° to 50°C.

Line voltage: < ± 5 parts in 10^8 for 10% line variation.

Oscillator output: 10 MHz, approximately 1 V rms at rear panel BNC, 100 Ω source impedance.

External input: 1 to 10 MHz, 1 V rms into 500 Ω .

General

Display: 6-digit, dot matrix (5300A) or 8-digit, 7-segment matrix (5300B), solid state LED display (gallium arsenide phosphide light emitting diodes) including decimal point and annunciator units.

Overflow: LED light indicates when display range is exceeded.

Display storage: holds reading between samples. Sample rate: Sample rate control adjusts the delay from the end of one measurement to the start of a new measurement. Continuously variable from less than 50 msec to greater than 5 seconds. **HOLD** position: display can be held indefinitely. **Reset:** Front panel pushbutton switch resets all registers and initiates new measurement. Reset input by contact closure to ground or TTL type low level also available on rear panel connector (5300A only).

Operating temperature: 0° to 50°C.

Power requirements: 115 V + 13, -17% 48-440 Hz; 230 V + 13, -17% 48-60 Hz, 25 VA maximum (depends on plug-on module). Mainframe power without plug-on nominally 5 watts. Battery operation: with 5310A re-chargeable battery pack (see 5310A specifications).

Dimensions: (with snap-on module): 89 mm H x 160 mm W x 248 mm D (3.5" x 6.25" x 9.75").

Digital Output (5300A Only)

Digital serial, 4-bit BCD parallel available at rear panel connector.

The 10533A Digital Recorder Interface accessory provides an interface between the 5300A measurement system mainframe and a standard parallel-input recorder such as the HP 5055A. The interface module provides conversion from the 5300A serial data output to a standard parallel format.

Code: 4-line 1-2-4-8 BCD; "1" state low TTL levels.

Decimal point: floating decimal point automatically inserted at correct digit position.

Print command: negative step, TTL levels.

Inhibit input: +2.0 V or higher prevents the 5300A from recycling.

Note: digital output for 5300B Mainframe is provided by 5312A HP-IB Interface module.

Mainframe/Plug-On Compatibility

Plug-on	Display Digits	
	with 5300A	with 5300B
5301A	6	7
5302A	6	7
5303B	6	8
5304A	6	7
5305B	N/A	8
5306A (Frequency)	6	7
(ACV,DCV,OHMS)	5	5
5307A	6	6
5308A	N/A	8

Accessories

10533A Digital recorder interface: (for use with 5300A) \$325

10548A Service support package: Contains an interface card and 4 diagnostic cards for easy trouble shooting of 5300A or 5300B \$110

18019A Leather carrying case: Holds 5300A or 5300B, snap-on module and 5310A battery pack plus accessories \$45

Rack Mount Kits

10851A Single	\$70
10852A Double	\$80
10853A Single/with plug-between	\$90
10854A Double/with plug-between	\$100

Ordering Information

5300A 6 digit mainframe \$825

5300B 8 digit mainframe \$700

Opt 001: TCXO (5300B only) add \$225

ELECTRONIC COUNTERS

5300A/B System (cont.)

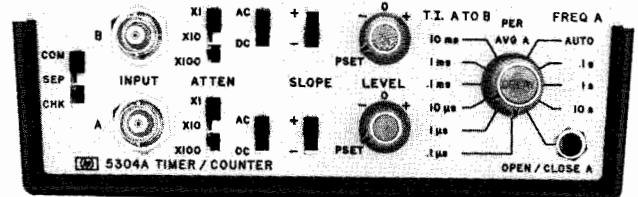
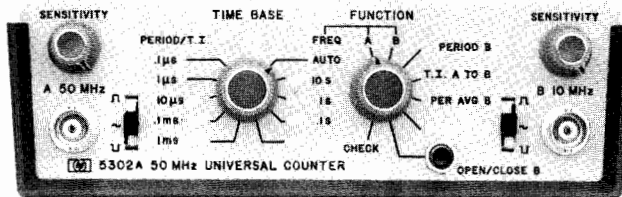
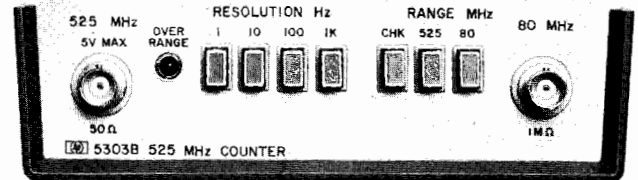
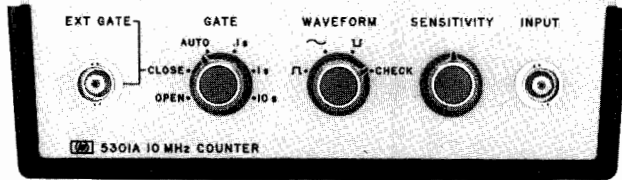
**5301A 10 MHz Frequency Counter Module****Input**

Range: 10 Hz to 10 MHz.

Sensitivity (min): 25 mV rms sine wave 50 Hz to 1 MHz, 50 mV rms sine wave 10 Hz to 10 MHz.

Frequency Measurement

Range: 10 Hz to 10 MHz.

Gate times: manually selected 0.1, 1, or 10 seconds AUTO position selects gate time of 1 second for maximum resolution.

Open/Close (Totalizing)

Range: 10 MHz max count rate.

5302A 50 MHz Universal Counter Module**Input Channels A and B**

Range: Channel A: 10 Hz to 50 MHz, Channel B: 10 Hz to 10 MHz.

Sensitivity (min): 25 mV rms sine wave 50 Hz to 1 MHz, 50 mV rms sine wave 10 Hz to 10 MHz, 100 mV rms sine wave at 50 MHz, 150 mV p-p pulse at minimum pulse width, 50 ns.

Trigger level: selectable position, negative, or zero volts.

Marker outputs: rear BNC, TTL low level while gate is open.

Frequency

Range: Channel A: 10 Hz to 50 MHz, prescaled by 10; Channel B: 10 Hz to 10 MHz.

Gate times: manually selected 0.1, 1, or 10 seconds. AUTO position selects gate time of 1 second for maximum resolution.

Time Interval A to B

Range: 50 nsec to 1000 seconds.

Resolution: 100 ns to 1 ms in decade steps.

Period B

Range: 10 Hz to 1 MHz.

Resolution: 100 ns to 1 ms in decade steps.

Period Average B

Range: 10 Hz to 1 MHz.

Periods averaged: 1 to 10³ automatically selected.

Frequency counted: 10 MHz.

Ratio

Display: F_A/F_B times multiplier (N), $N = 10$ to 10^7 .

Range: Channel A: 10 Hz to 1 MHz, Channel B: 10 Hz to 10 MHz.

Open/Close (Totalizing)

Range: 10 MHz max.

5303B Frequency Counter Module**Input Channel A (CW or Burst)**

Range: DC to 525 MHz, prescaled by 8.

Sensitivity (fixed): 100 mV rms sine wave, dc to 500 MHz, 125 mV rms sine wave, 500 MHz to 525 MHz. Signal must pass through zero.

Input Channel B (CW or Burst)

Range: 50 Hz to 80 MHz, direct.

Sensitivity (automatic): 25 mV rms sine wave, 100 Hz to 50 MHz, 50 mV rms sine wave, 50 Hz to 100 Hz and 50 MHz to 80 MHz. Sensitivity is adjusted automatically by Automatic Gain Control.

Frequency Measurement

Resolution: selectable: 1, 10, 100, 1000 Hz.

Opt 001: High Stability Time Base (for use with 5300A)

Frequency: 10 MHz.

Stability

Aging rate: < 1.2 part in 10⁶/year.

Temperature: < ± 5 parts in 10⁷, 0° to 50°C.

Line voltage: < ± 5 parts in 10⁸ for 10% line variation.

Oscillator output: 10 MHz, approx. 1 V rms at rear panel BNC.

External input: 1 to 10 MHz, 1 V rms into 500Ω.

5304A Timer/Counter Module**Input Channels A and B**

Range: DC coupled; 0 to 10 MHz; AC coupled: 100 Hz to 10 MHz.

Sensitivity (min): 25 mV rms sine wave to 1 MHz, 50 mV rms sine wave to 10 MHz, 150 mV p-p pulse at minimum pulse width, 40 nsec. Attenuator reduces sensitivity by 10 or 100 times.

Trigger level: PRESET position centers triggering about 0 volts, or continuously variable over the range of -1 V to +1 V.

Gate output: rear panel BNC. TTL low level while gate is open.

Time Interval A to B

Range: 500 ns to 10⁴ sec.

Resolution: 100 ns to 10 ms in decade steps.

Time interval holdoff: inserts variable delay of approximately 100 μs to 100 ms between START and enabling of STOP, may be disabled. Electrical inputs during delay time are ignored.

Period Average A

Range: 10 Hz to 1 MHz.

Periods averaged: 1 to 10³ automatically selected.

Frequency counted: 10 MHz.

Frequency A

Range: 0 to 10 MHz.

Gate times: manually selected 0.1, 1, or 10 seconds. AUTO position selects gate time to 1 second for maximum resolution.

Open/Close (Totalizing)

Range: 10 MHz max.

Ordering Information

5301A 10 MHz Frequency Counter Module

5302A 50 MHz Universal Counter Module

5303B 525 MHz Counter

Opt 001: High Stability Time Base

5304A Timer/Counter Module

Price

\$300

\$550

\$1100

add \$225

\$600

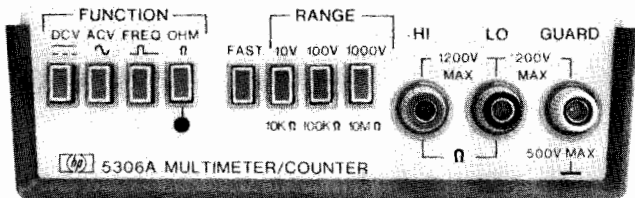
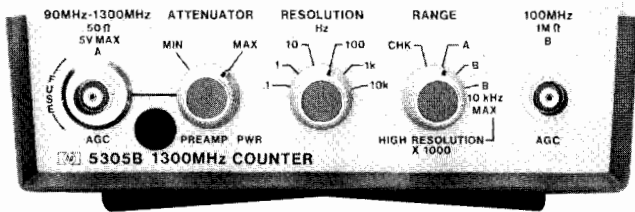

5305B 1300 MHz Frequency Counter Module

Input Channel A (CW or Burst)

Range: 90 MHz to 1300 MHz, prescaled by 16.

Sensitivity: 20 mV rms.

Impedance: 50Ω.

Attenuator: continuously variable for signals up to 3.5 V rms.

Operating dynamic range: >47 dB

Input Channel B (Normal and High Resolution Mode)

Range: 50 Hz to 100 MHz in normal mode. 50 Hz to 10 kHz in high resolution mode.

Sensitivity: 20 mV rms.

Frequency Measurement

Resolution (selectable)

Normal mode (50 Hz to 1300 MHz): 0.1 Hz to 10,000 Hz corresponding to gate times of 10 s to 0.0001 s on channel B and to gate times of 160 s to 0.0016 s on channel A.

High resolution mode (50 Hz to 10 kHz): 0.0001 to 10 Hz corresponding to 10 to 0.0001 second gate times on channel B.

5306A Digital Multimeter/Counter Module

DC Voltage

Sensitivity: 100 μV for 10 V range, 1 mV for 100 V range, 10 mV for 1000 V range.

Sample times: Normal, 0.5 sec; fast, 0.05 sec.

Effective common mode rejection (1 kΩ imbalance): DC: > 80dB; 50Hz or 60Hz ± 0.1%: >80dB.

Normal mode rejection: 50 Hz or 60 Hz ± 0.1%: > 50 dB.

AC Voltage

Frequency: 40 Hz to 100 kHz for 10 V range, 40 Hz to 500 Hz for 100 V range, 40 Hz to 500 Hz for 1000 V range.

Effective common mode rejection (1 kΩ imbalance): DC: > 80 dB; 50 Hz or 60 Hz ± 0.1%: > 50 dB.

Ohms

Sensitivity: 0.1 Ω for 10 kΩ range, 1 Ω for 100 kΩ range, 100 Ω for 10 MΩ range.

Current through unknown: 1 mA on 10 kΩ range; 100 μA on 100 kΩ range; 1 μA on 10 MΩ range.

Frequency

Range: 40 Hz to 10 MHz.

Sensitivity (min): 50mV rms to 1MHz; 125mV rms to 10MHz.

Trigger level: Automatically adjusts to 40% of peak level of input.

Gate times: normal: 1 sec, fast: 0.1 sec.

5307A High Resolution Counter Module

Input

Range: Hz mode: 5 Hz to 2 MHz. CPM mode: 50 to 10 M counts/minute (0.8333 Hz to 166 KHz).

Sensitivity (min.):	Hz	CPM
10 mV rms	5 Hz-1.2 MHz	120 CPM-10 MCPM
25 mV rms	1.2 MHz-2.0 MHz	50 CPM-120 CPM

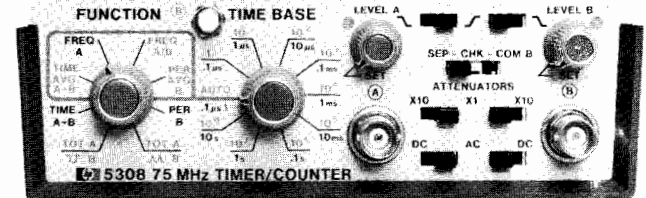
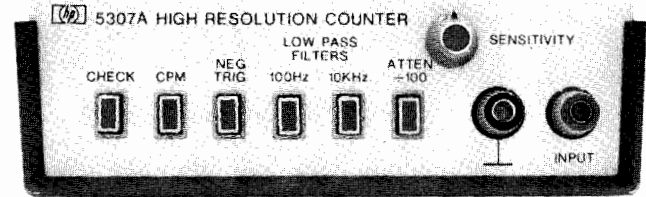

Pulses: For low duty-cycle pulses (<15%); 15 mV peak for 250 nsec pulses, 100 mV peak for 100 nsec pulses.

Low pass filters: (3 dB point) **100 Hz** **10 kHz**
Max. attenuation 60 dB 40 dB
Roll-off 20 dB per decade

Frequency Measurement

Periods averaged: automatically selected for maximum resolution.

Measurement time: varies from 312 ms to 815 ms.

5308A Universal Timer/Counter Module

Input (Channels A and B)

Range: DC coupled; 0 to 75 MHz, AC coupled; 20 Hz to 75 MHz.

Sensitivity (min): 25 mV rms to 10 MHz, 50 mV rms to 75 MHz, 150 mV p-p pulse at pulse width of 10 nsec.

Trigger level: variable over the range of ± 2.0 V and ± 20 V.

Rear outputs: gate, trigger levels and time base/scaling.

Frequency

Range: 0 to 75 MHz, Channel A or Channel B.

Gate times: 8 selectable times from 1 μs to 10 s.

Frequency Ratio

Display: Fa/Fb, 1 to 10⁸ periods selectable manual or auto.

Range: Channel A: 0 to 75 MHz, Channel B: 0 to 5 MHz.

Period

Range: 0 Hz to 5 MHz, Channel B.

Resolution: 100 nsec to 10 sec.

Period Average

Range: 0.1-5 MHz; (200 nsec to 10 sec), Channel B.

Periods averaged: 1-10⁸ selectable manual or automatic.

Time Interval A — B

Range: 200 nsec to 10⁹ sec. 25 ns minimum pulse width.

Resolution: 100 nsec to 10 sec.

Time Interval Average A — B

Range: 1 ns to 10 s, 200 ns dead time between intervals.

Intervals averaged: 1 to 10⁸, selectable manual or automatic.

Totalize

totalizes Channel A while Channel B is low.

totalizes Channel A between pulses on channel B.

Range: 75 MHz in X1 position, 5 MHz in X10⁸ positions.

General

Auto position: automatically sets time base to give maximum resolution within 1.1 seconds measurement time for Frequency, Frequency Ratio, Period Average, and Time Interval Average.

Ordering Information

5305B 1300 MHz Counter **Price** \$1175

10855A: Preamp: 22dB gain with ± 1 dB flatness \$375

from 2 MHz to 1300 MHz.

5306A Digital Multimeter/Counter \$900

5307A High Resolution Counter \$575

5308A 75 MHz Timer/Counter \$700

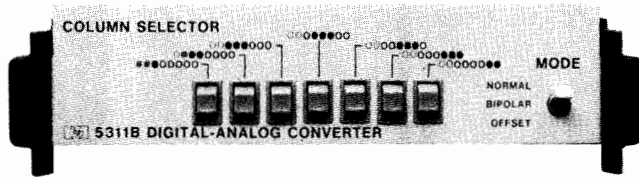

5311B Digital-to-Analog Converter Module

Operating Modes

Three modes selectable by switch on front panel.

Mode	Output		
	0 to 50% of Scale	50% of Scale	50% to 100% of Scale
Normal	0 to 499	500	501 to 999
Plus/Minus	-999 to -001	000	001 to 999
Offset	500 to 999	000	001 to 499

Output Selection

Manual pushbuttons to select any three consecutive digits or the last two digits of the mainframe display.

Output Ranges

Potentiometric recorder output: 0.1 V, 1.0 V, or 10 V full scale into >20 kΩ. Dual banana plugs.

Galvanometer recorder output: 1 mA full scale into <1.5 kΩ phone jack.

General

Accuracy: ±0.25% of range ±50 μV/°C on potentiometric output, ±20 nA/°C on galvanometer output after calibration for appropriate range.

Calibration: zero and full scale calibration switch and adjustments on rear panel.

Transfer time: <5 ms.

Operating temperature: 0° to 50°C.

Power requirements: nominally 1 watt.

Weight: net, 0.8 kg (1.7 lb). Shipping, 1.4 kg (3.0 lb).

Size: Digital-to-Analog Converter plugs between Mainframe and plug-on module. Increases height of instrument by 38.4 mm (1.5").

5311B Digital-Analog Converter \$525

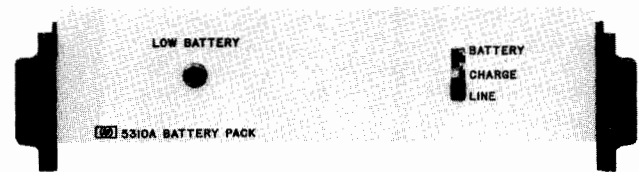

5310A Battery Pack Module

Battery capacity: 48 watt-hours, nominal. Minimum 3, typically 5, hours of continuous operation at charging and operating temperature (20° to 30°C).

Recharging time: 18 hours from minimum level (indicated by Low Voltage Indicator) to full charge.

Battery voltage: 12 Vdc.

Low voltage indicator: solid state warning light begins to glow at approximately 90% discharge.

Line failure protection: allows instrument to be operated in LINE position with automatic switch-over to battery power if line voltage fails. Batteries receive trickle charge in LINE position to maintain charge.

Operating temperature: operating 0° to 50°C. Charging: 0° to 40°C, mainframe not operating.

Power requirements: charging power via mainframe, nominal 7.5 watts.

5310A Battery Pack Module \$375



5312A HP-IB (ASCII) Interface Module

The 5312A outputs fifteen characters of information in the following format.

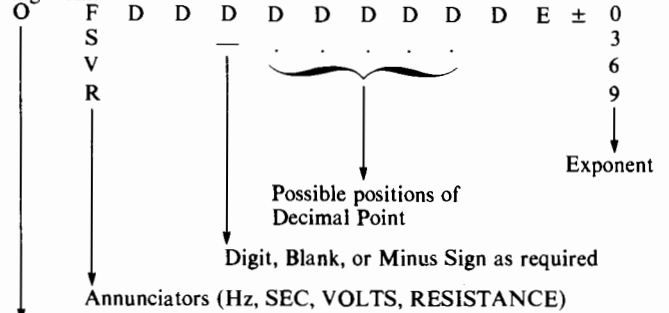

Overflow indicator

General

Sample rate: controlled by mainframe front panel control or by setting rate of reset command (when in listening mode, counter can be reset by sending "initialize" command).

Transfer time: 20 milliseconds.

Transfer rate: maximum of 40 reading/sec depending on capabilities of plug-on.

Programmability: 5300 measuring system front panel controls are not programmable.

Note: the 5312A is not compatible with the 5300A mainframe which contains its own BCD digital output.

5312A HP-IB Interface \$475

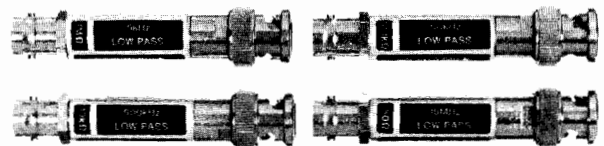

10856A Low Pass Filter Kit

The four low pass filters of the 10856A filter kit are recommended for use with any HP frequency counter to reduce high frequency noise or unwanted signals that cause frequency or period measurement errors. For use in calibration of frequency standards or instrument time bases, a 15 MHz, 50 Ω filter has been included. Further applications for the kit include reducing noise (trace fuzz) in oscilloscope and spectrum analyzer displays.

Specifications

Cut Off Frequency (NOMINAL)	5 KHz	50 KHz	500 KHz	15 MHz
Input Impedance (NOMINAL)	1 MΩ	100 kΩ	10 kΩ	50 Ω
Signal Rejection, 100 MHz to 500 MHz	>40 dB	>40 dB	>40 dB	>20 dB

Roll-off: 20 dB per decade.

Attenuation: x 2, reduces signal voltage by a factor of 2.

Output impedance: for use with 1 MΩ input instruments.

10856A Low Pass Filter Kit \$125

ELECTRONIC COUNTERS

Low Cost Counters for Frequency Measurements

Models 5381A, 5382A & 5383A

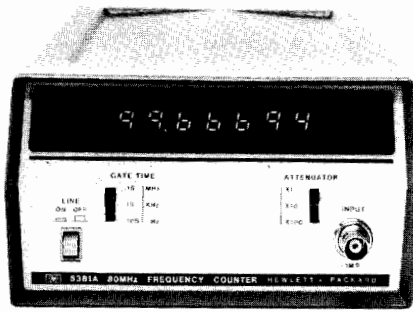

5381A

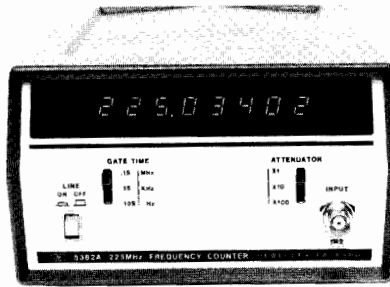

5382A

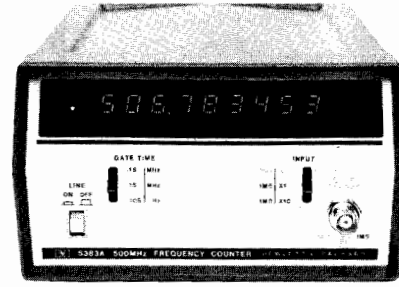

5383A

Description

General

The 5381A, 5382A and 5383A are a logical result of HP's long-standing leadership in frequency counter development. Leadership in quality, technology and efficient production procedures allows HP to offer a superb price/performance combination in these three precision instruments. These counters are designed to deliver reliable, high quality operation in such diverse areas as: production line testing, service and calibration (two-way radio and test equipment), frequency monitoring, education and training.

Resolution

The 5381A, 5382A and 5383A employ the direct counting technique and, with 7, 8 and 9 digits respectively, offer resolution of 10 Hz in 0.1 sec., 1 Hz in 1 sec and 0.1 Hz in 10 seconds.

Specifications

5381A

Frequency range: 10 Hz to 80 MHz.
Sensitivity: 25 mV rms—30 Hz to 20 MHz, 50 mV rms—10 Hz to 80 MHz.
Input impedance: 1 M Ω , <50 pF.
Input attenuation: X1, X10, X100.
Accuracy: ± 1 count \pm time base error.
Resolution: direct count; 1 Hz in 1 second.
Gate times: 0.1 second, 1 second, 10 seconds.
Display: 7 LED digits.
Rear panel input: sensitivity: TTL levels or 2.5 V rms.
Ratio: Rear Panel Input, 10 kHz to 2 MHz.
External frequency standard: Rear Panel Input, 1 MHz.
Time Base
Frequency: 1 MHz.
Aging: <0.3 ppm/month.
Temperature: ± 10 ppm 0°C to 40°C.
Line voltage: ± 1 ppm for 10% line change.

5382A

Frequency range: 10 Hz to 225 MHz.
Sensitivity: 25 mV rms—30 Hz to 10 MHz, 50 mV rms—10 Hz to 225 MHz.
Input impedance: 1 M Ω , <40 pF.
Input attenuation: X1, X10, X100.
Accuracy: ± 1 count \pm time base error.
Resolution: direct count; 1 Hz in 1 second.
Gate time: 0.1 second, 1 second, 10 seconds.
Display: 8 LED digits, nonsignificant zero blanking.
Rear panel input: sensitivity: 250 mV rms.
Ratio: Rear Panel Input, 100 kHz to 10 MHz.
External frequency standard: Rear Panel Input, 10 MHz.
Time Base
Frequency: 10 MHz.
Aging: <0.3 ppm/month.
Temperature: ± 2.5 ppm 0°C to 40°C.
Line voltage: ± 0.5 ppm for 10% line change.

5383A

Frequency range: 10 Hz to 520 MHz.
Sensitivity:
 1 M Ω : 25 mV rms—20 Hz to 10 MHz.
 50 mV rms—10 Hz to 50 MHz.
 50 Ω : 25 mV rms—20 Hz to 520 MHz.
Input impedance: selectable: 1 M Ω , <40 pF or 50 Ω .
Input attenuation: 1 M Ω x 1, x 10; 50 Ω x 1—fuse protected.
Accuracy: ± 1 count \pm time base error.
Resolution: direct count: 1 Hz in 1 second.
Gate time: 0.1 second, 1 second, 10 seconds.
Display: 9 LED digits, nonsignificant zero blanking.
Display test: RESET function (activated with GATE TIME switch) illuminates all segments of all digits.
Rear panel input: sensitivity: 250 mV rms.
Ratio: Rear Panel Input, 100 kHz to 10 MHz.
External frequency standard: Rear Panel Input, 10 MHz.
Time Base Output
Frequency: 10 MHz.
Voltage: 200 mV p-p into 50 Ω load.
Control: active with Rear Panel Internal/External switch in internal position.
Time base
Frequency: 10 MHz.
Aging: <0.3 ppm/month.
Temperature: ± 2.5 ppm 0°C to 40°C.
Line voltage: ± 0.5 ppm for $\pm 10\%$ line change.

TCXO Option

Opt 001: (available for all models) Temperature Compensated Crystal Oscillator time base
Frequency: 10 MHz.
Aging: <0.1 ppm/month.
Temperature: <1 ppm 0°C to 40°C.
Line voltage: ± 0.1 ppm for $\pm 10\%$ line change.
Note: Time base output available for both 5382A and 5383A with Option 001. Rear Panel Input not available.

5380 Family General Data

Overflow: LED lamp indicator when most significant digit overflows.
Reset: manual selection of reset occurs when GATE TIME switch is between three normal positions.
Package: rugged, high strength metal case.
Operating temperature: 0°C to 40°C.
Power requirements: 100, 120, 220, 240, V rms (+5%, -10%) 48-440 Hz; 20 VA maximum.
Weight: net, 2.2 kg (4 $\frac{1}{2}$ lb). Shipping, 2.8 kg (6 lb).
Dimensions: 98 H x 60 W x 248 mm D (3.5" x 6.25" x 9.75").

Ordering Information

5381A Frequency Counter
 5382A Frequency Counter
 5383A Frequency Counter
 Opt 001: TCXO (all models)

Price

\$425
 \$550
 \$825
 add \$125

PULSE & DATA GENERATORS

General Information

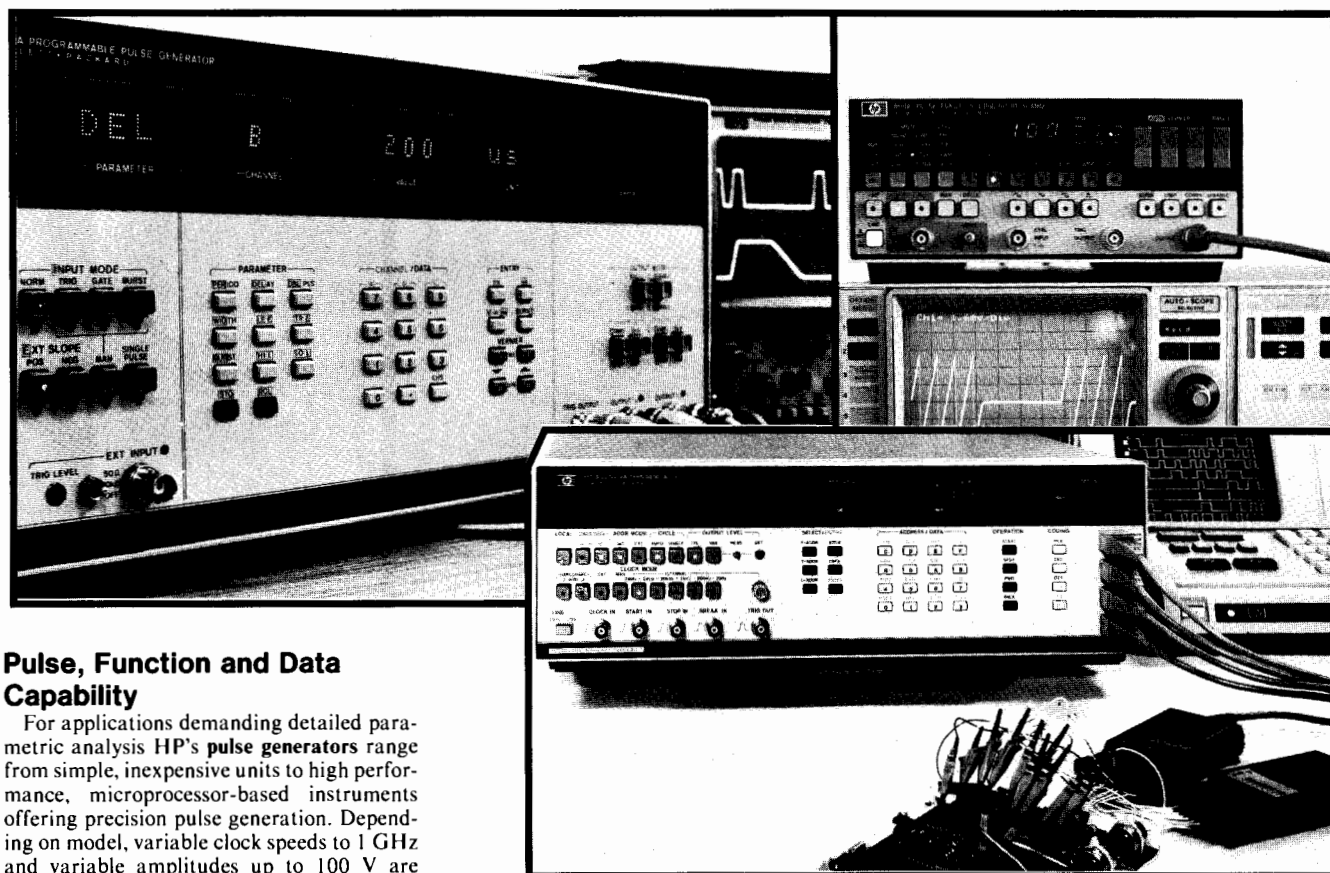

Pulse, Function and Data Capability

For applications demanding detailed parametric analysis HP's **pulse generators** range from simple, inexpensive units to high performance, microprocessor-based instruments offering precision pulse generation. Depending on model, variable clock speeds to 1 GHz and variable amplitudes up to 100 V are available.

In situations where analog as well as digital devices are tested, **pulse/function generators** are a convenient, cost-effective alternative to separate sources. Compounding the capabilities of pulse generators and function generators these instruments offer outstanding flexibility.

Where functional as well as parametric checkout of digital circuits is needed, **HP data generators** offer programmable serial or parallel data. Control capability—such as start, stop, strobe and enable—enhances logic analysis and speeds testing.

Features

Logical front panel layout helps quick familiarization and rapid, error-free use. In

addition, great emphasis is placed on ruggedness, reliability and serviceability. The generators are developed and produced using high quality standard components and custom-designed ICs. Resultant technical benefits are, for example, broad operating temperature range and clean 50-ohm output impedance.

The more recent additions to the pulse/data generator range are microprocessor managed. Many user oriented features emerge such as: storage of complete mode and parameter sets, identical command sequences for both remote and front panel operation, LED display of individual parameter values, and precise error indication for rapid

correction of incompatible instructions. Direct benefits of this new generation of HP test instruments are faster setup times in bench applications, and reduced software costs in automatic test systems.

Data Generators

Hewlett-Packard's range of data generators offers multi-channel and single channel capability to suit parallel or serial data needs. Standard features include:

- freely programmable memory.
- manual and remote memory programming for bench and automatic test setups.
- variable clock speeds for dynamic test capability.

Data Generator Selection Chart

	8080 System	8018A	8016A	8170A
Max. rep rate (MHz)	300	50	50	2
No. of channels	1	2	9	8/16
Bits per channel	16/32/64	1024 _{var}	32	4K/2K
Serialized bits	up to 64	up to 2048	up to 256	
Output	2 V/ECL	15 V	ECL/TTL	TTL/CMOS
Width/Delay control			•	
RZ/NRZ formats	•	•	•	NRZ
PRBS		•		
Programmable		HP-IB Option	HP-IB Option	HP-IB RS 232C
Catalog page	364	367	370	368

Logic Family Selection Chart

Logic Family	Parametric Test	Functional Test
CMOS	8011A, 8015A, 8160A, 8111A, 8116A	8018A, 8170A
TTL	8012B, 8013B, 8116A, 8015A, 8160A, 8016A	8016A, 8018A, 8170A
S-TTL	8007B, 8082A, 8016A	8016A, 8018A
ECL	8082A, 8016A, 8080 System, B161A	8080 System, 8016A, 8018A



- switchable output levels for easy logic family selection. These levels are also adjustable so that marginal conditions can be determined.
- versatile synch capability simplifies stimulus/device/response hook-up and gives positive recognition of events in the data stream.

Serial Applications

Some generators offer pseudo-random binary sequences (prbs) as well as programmed data. Thus avionic, telecommunications, fiber optic and other equipment requiring extremely long, non-repetitive data streams can be stimulated. Even preamble-data-postamble encoding such as that used in PCM telephone networks can be conveniently simulated by selecting a mode which combines prbs with programmed data. For research, data rates up to 300 Mbit/s with very fast pulse edges are available.

Parallel Applications

To meet parametric and functional needs, multichannel data is available with variable slew and pulse width. Thus, combined with bit rate and output magnitude variability, the performance limits of ICs and digital PC boards can be rapidly established.

For shared-bus devices, comprehensive control features are essential. Handshake and address capabilities ensure thorough checkout under 'real' conditions, independent of other system components.

Pulse Generators and Pulse/Function Generators

Pulse generators range from pure bench units to high performance models which offer precision control over all pulse parameters, full HP-IB capability and microprocessor control. Dual channel models, giving multi-level and complex waveform capabilities, are available.

Offering two-instrument-in-one capability, pulse/function generators save space and investment. Choice of waveform, trigger mode and modulation mean wide applicability which ensures a long-term investment.

Independent Parameters, Thorough Specifications

All variable parameters can be independently adjusted and are thoroughly specified under all operating conditions. For quick reference this catalog shows the leading properties. Detailed specifications are contained in the instrument data sheets.

The main terms used to specify HP pulse generator performance are outlined on page 366.

Counted Burst Capability

HP's burst mode ensures absolutely stable bursts; all pulse parameters can be varied without affecting the number of pulses generated. Requiring neither internal nor external gate signals, gate jitter is eliminated.

Convenient 50-Ohm Output Impedance

All HP's pulsers have a constant 50-ohm source impedance. Signal reflections are thus absorbed so that re-reflections into the circuit-under-test are avoided. The 50-ohm source allows back-terminated operation so that high-impedance loads may be driven without an external terminating resistor.

In addition, for applications requiring a high source impedance, many HP pulse generators offer a selectable 1k ohm output.

Pulse addition, branching, inversion

In addition to the format dual channel and complex waveform capabilities of standard pulse generators, handy accessories are also available for more hookup flexibility. Refer to page 711.

Time Synthesizers

Time Synthesizers are mainly used in radar and laser ranging, component and circuit testing, and precise triggering and calibrating applications. They give a precisely timed output pulse with an accurate, adjustable delay which may be incremented in steps as small as 50 pico-seconds. A fixed, virtually jitter-free insertion delay allows phase locking to equipment under test.

Pulse Generator Selection Chart

	Pulse Generators											Pulse/Function Generators ~. ~. ~. ~. ~. ~. ~.			Time Synthesizer
	214B	8005B	8011A	8012B	8013B	8015A	8007B	8082A	8080 System	8160A	8161A	8111A	8116A	8165A	5359A
Timing															
Max frequency (MHz)	10	20	20	50	50	50	100	250	300/1000	50	100	20	50	50*	10
Transition time (ns)	15	10 var	10	5 var	3.5	6 var	2 var	1 var	0.8/0.3	6 var	1.3 var	10	6	5	5
Var width (ns) min	25	25	25	10	10	10	5	2		10	4	25	10	10	5
Square/duty cycle (%)	1-10	Sq	Sq	Sq	Sq	Sq	Sq	Sq	Sq			10-90	10-90	20/50/80	
Variable delay	•	•		•	•	•	•	•	•	•	•				•
Haver												•	•		Special option
Output (max values are quoted: see specifications for conditions).															
Amplitude (V)	100	10	16	10	•	30	10	5	4/2.4	20	5	32	32	20	5
Offset/Window (V)		±4/±10		±2.5/±7.5	±2.5/±7.5	±28/±16	±8/±18	±2/±5	±2/±4	±20/±20	±5/±5	±16/±16	±16/±16	±10/±10	±1/±6
Format	+/-	•	•	•	•	•	•	•	•	•	•	•	•	•	+/-
• = positive, negative, symmetrical, normal and complement formats.															
Outputs	1	+ and -	1	1	+ and -	2	1	1	Configurable	2-chan option	2-chan option				
Additional outputs		TTL				TTL		Compl			Compl				Edge 1,2
Modes															
Trigger	•	•	•	•	•	•	•	•	•	•	•	•	•	•	•
Ext width				•	•	•	•	•	•						•
Gate	•	•		•	•	•	•	•	•	•	•	•	•	•	
Ext burst	Option		Option			Option				•	•	Option	Option	•	
Int burst													Option		
Double pulse	•	•		•	•	•	•	•		•	•				
Modulation (FM, AM, PW, VCO require external modulating signal).															
FM													•	•	
AM													•	Option	
PWM													•		
VCO												Option	•	•	
Sweep													Option	Option	
Programmability						Analog option				HP-IB	HP-IB		HP-IB	HP-IB	HP-IB
Catalog page	357	358	358	360	360	361	362	363	364	350	350	359	353	355	356

* PLL gives improved accuracy in Normal mode.



PULSE & DATA GENERATORS

Programmable Pulse Generators

Models 8160A, 8161A

- 50 MHz repetition rate
- 6.0 ns variable transition time
- 20 V output amplitude
- 1-3% pulse parameter accuracy
- Full dual channel capability (option 020)
- 1 year recalibration period

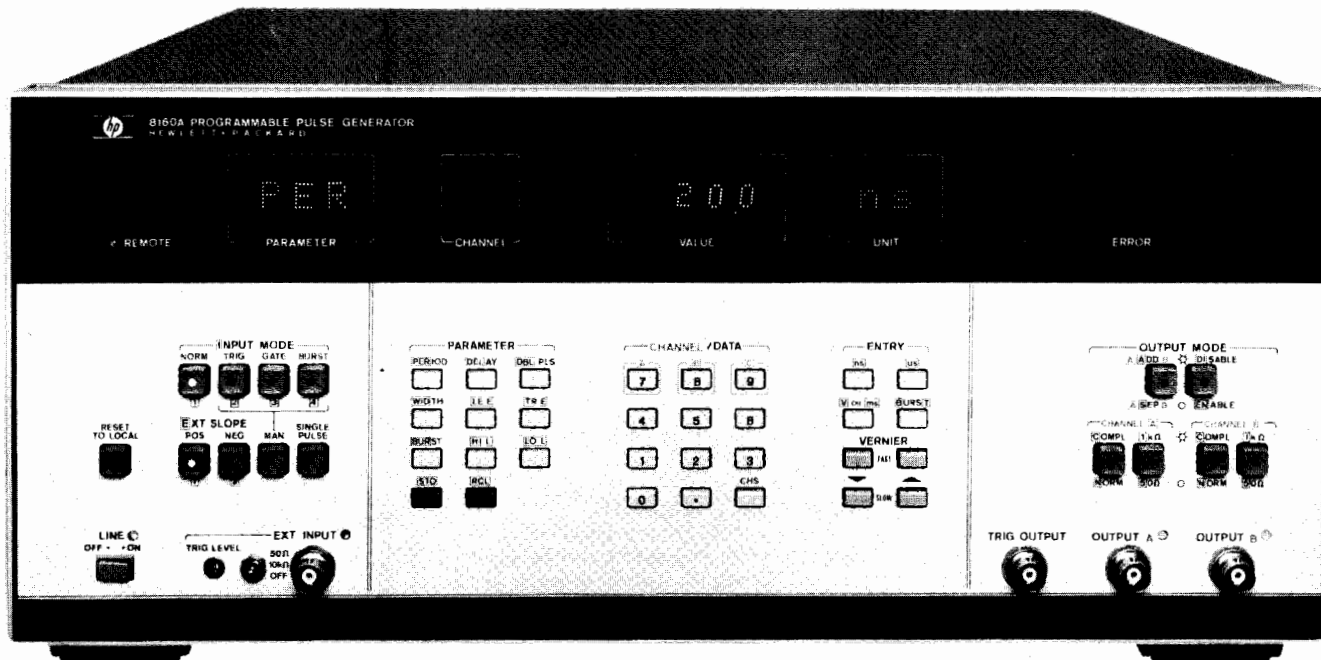

8160A Option 020
Dual Channel



- 100 MHz repetition rate
- 1.3 ns variable transition time
- 5 V amplitude
- 1-3% basic timing accuracy
- Full dual channel capability (Option 020)
- 1 year recalibration period

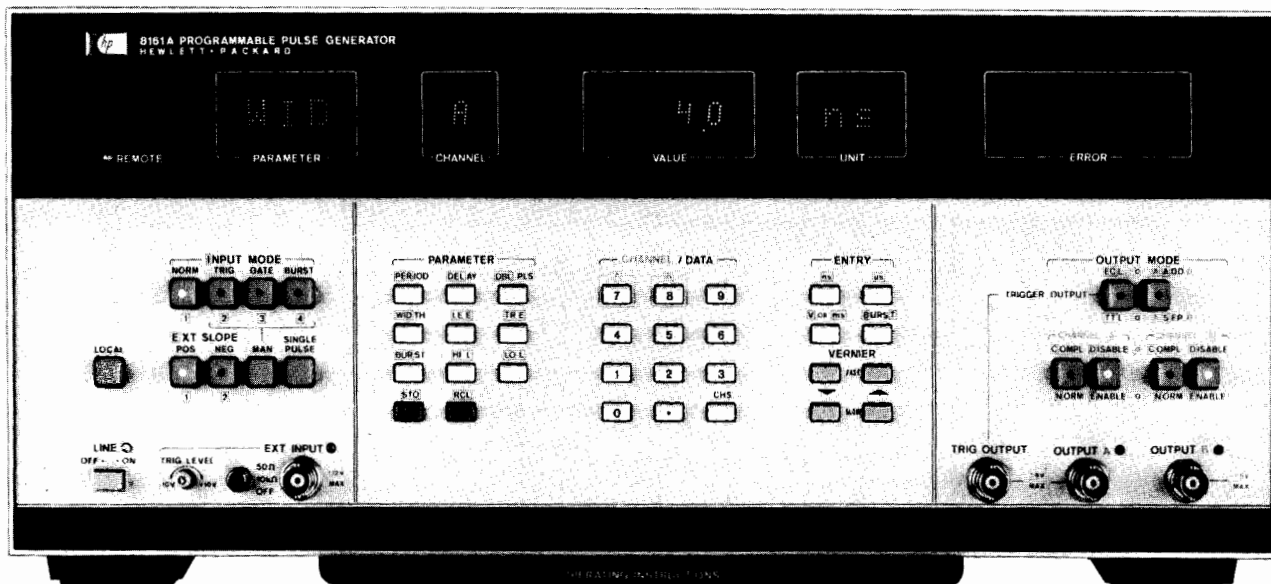

8161A Option 020
Dual Channel





The 8160A and 8161A are fully programmable pulse generators designed for high performance applications on the bench and in automatic test systems. Operation is made easy because the pulse parameters are controlled independently and do not inter-react. Dual channel options permit synchronous or complex waveforms to be generated. With its 50 MHz repetition rate, 20 V output, and 6 ns variable transition times, the **8160A** is a general purpose pulse generator. The **8161A** covers the high end of technology with its 100 MHz, 5 V and 1.3 ns variable transition times. Measured between the 20% to 80% amplitude points, these transitions are faster than 1 ns and meet ECL requirements.

Combining high programming accuracy with microprocessor-based control capabilities, pulses can be set up without a measuring instrument. Pulse parameters are entered and displayed numerically, and generated with a basic timing accuracy of 1-3%, depending upon parameter.

An easy-to-use HP-IB interface brings high-accuracy pulses to automatic test. All parameters and operating modes are remotely programmable using straight-forward command sequences. Faster, easier program generation and reduced software costs are direct benefits.

Precision Pulse Generation

Both models provide precision control over all parameters of their output pulses. The 8160A's leading and trailing edge transition times may be independently programmed down to 6 ns. The 8161A's transitions have a common control from 1.3 ns to 5 ns, and are independent above 5 ns. Variable transition times are indispensable when digital IC's need to be characterized: either the IC's data sheeted input transition time is required, or the IC's functioning range with various transitions needs to be evaluated.

Direct entry of the high and low levels of the output pulse enables easy adjustment to the logic levels concerned. Pulse width is variable from 4 ns (8161A) or 10 ns (8160A) to 1 s, giving a wide range of duty cycle programmability. Delay shifts the output pulse in relation to the trigger output or, in double pulse mode, defines the pulse spacing.

In the dual-channel versions, double pulse can be selected in either or both channels. This means, for example, that simultaneous clock and data signals can be generated.

Complex Signals

Independent pulse parameters plus individual programmability of the Option 020's dual outputs are augmented by the A ADD B mode. Summation allows complex signals to be precisely and easily set up. Here are some examples:

Applications such as radar coincidence circuits and special codes in communications require 3- and 4-level signals. These are conveniently generated by combining channel A and channel B pulses.

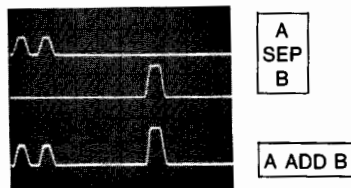
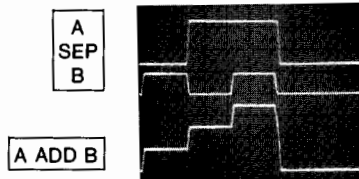

Transponder circuits need accurate delays, often with respect to a double-pulse interrogation signal. In the 8160A, this is arranged by operating one channel in double pulse mode and setting up the transponder delay in the other.

A critical test for digital circuits and IC's is its glitch and noise sensitivity, which can be easily performed with the A ADD B mode.

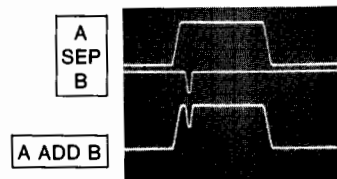

Counted Burst

Using Burst Mode, a predetermined number of pulses is generated independent of frequency. Bursts from 0 to 9999 pulses in length may be produced, and can be triggered via an external signal manually or with an HP-IB command.

Wide temperature range for system reliability

The 8160A's and 8161A's 0-50°C operating range ensures calculable performance. Indeed, temperatures will generally be between 20-40°C where there is no derating factor.

User Features

Fast, Reliable Setup

Microprocessor control promotes highly accurate pulses. Parameters are directly entered via the instrument's keyboard, and are then displayed on numeric LED's with 3-digit resolution.

In bench applications, the vernier controls give a fine adjust capability to "tweak-in" any pulse parameter. You can increment or decrement the selected parameter either in single steps or at speed.

Error detection by the microprocessor further simplifies pulse setup by solving the old problem of incompatible settings. Should pulse width exceed pulse period, for example, the microprocessor indicates a TIMING error. All possible mis-settings are detected and the type of error is indicated to aid rapid correction.

HP-IB Programming

Microprocessor control over all interface functions makes remote programming as easy and straight-forward as manual control. The instruments employ keystroke programming so that data entry via the HP-IB is an exact simulation of manual entry. Bus commands for each front panel key simply replace manual keystrokes.

Parameter Storage

Complete parameter and mode information for 9 independent instrument set-ups can be stored. Waveforms may be stored and recalled either manually or via the HP-IB.

By utilizing a single command to recall an entire instrument set-up, controller time is saved. In simple repetitive testing applications, storage of test waveforms gives a high degree of user convenience without an external controller.

Learn Mode

When interrogated by the system controller, the instruments output a character string to the interface bus. This string completely describes the pulser's current set-up or any one of its stored parameter sets. Using Learn Mode, you can enter and try out waveforms manually and then automatically transfer them via the HP-IB to the controller for storage in a program.

Verification Software for the 8160A

Test system accuracy is guaranteed by accessory software which verifies the 8160A's performance standards. The software is fully documented and comes recorded on a cassette suitable for Model 9825A Desktop Computer.

In the event of a failure, downtime is minimized because the software also delivers diagnostic information to accelerate repair and calibration.



PULSE & DATA GENERATORS

Programmable Pulse Generators

Models 8160A, 8161A (Cont.)

Specifications

(50-ohm source into 50-ohm load). Standard instruments are single channel. Option 020 provides independent dual channels with common pulse period.

Timing (with minimum transitions)	8160A	8161A
Period Range: Accuracy: Max Jitter:	20 ns to 999 ms. ±3% of progr value ±0.3 ns (period < 100 ns); ±2% of progr value (period ≥ 100 ns). 0.1% of progr value + 50 ps.	10 ns to 980 ms. ±3% of progr value ±0.5 ns (period < 100 ns); ±2% of progr value (period ≥ 100 ns). 0.1% of progr value + 50 ps.
Delay, Double Pulse, Width Delay Range: Double Pulse Range: Width Range: Accuracy: Max Jitter:	0.0 ns to 999 ms. 20.0 ns to 999 ms. 10.0 ns to 999 ms. ±1% of progr value ±1 ns. 0.1% + 50 ps (≤999 ns); 0.05% (999 ns < - ≤9.99 μs); 0.005% (>9.99 μs).	0.0 ns to 990 ms. 8.0 ns to 990 ms. 4.0 ns to 990 ms. ±1% of progr value ±1 ns. 0.1% + 50 ps (≤999 ns); 0.05% (999 ns < - ≤9.99 μs); 0.005% (>9.99 μs).
Output Signals (Voltages double with high load impedance) Output levels High Level Range: Low Level Range: Amplitude: Level Accuracy: Settling Time:	-9.89 V to 9.99 V. -9.99 V to 9.89 V. 0.10 V min, 9.99 V max. ±1% of progr value ±1% of ampl ±50 mV. 40 ns.	-4.95 V to 5.00 V. -5.00 V to 4.95 V. 0.06 V min, 5.00 V max. ±1% of progr value ±3% of ampl ±25 mV. 20 ns plus transition time.
Transition Times (10 - 90% amplitude) Leading Edge: Trailing Edge: Accuracy: Linearity:	6.0 ns to 9.99 ms. 6.0 ns to 9.99 ms. ±3% of progr value ±1 ns. ±3% for transitions > 30 ns.	1.3 ns to 900 μs. 1.3 ns to 900 μs. ±10% of progr value ±1 ns. ±5% for transitions > 30 ns.
Preshoot, Overshoot, Ringing:	±5% of ampl ±10 mV.	±5% of ampl ±10 mV (may increase to ±10% of ampl ±10 mV for transitions < 2.5 ns).
A ADD B:	Adds channel A and B outputs (Opt 020 only).	Adds channel A and B outputs (Opt 020 only).
Output Format:	Normal/Complement Selectable. (Independently selectable in each channel in Option 020.)	Simultaneous Normal and Complement Outputs. (Independently selectable in each channel in Option 020.)
Source Impedance:	50 ohm/1k ohm selectable.	50 ohm.
Auxiliary Inputs and Outputs External Input Trigger Level: Max Input: Min Amplitude: Slope: Min Pulse Width: Typical Input Resistance:	+10 V to -10 V. ±12 V in 50 ohm, ±20 V in 10k ohm. 500 mVpp. positive or negative. 3 ns. 50 ohm or 10k ohm.	+10 V to -10 V. ±12 V in 50 ohm, ±20 V in 10k ohm. 500 mVpp. positive or negative. 3 ns. 50 ohm or 10k ohm.
Trigger Output Output Levels: Typical Source Resistance: Typical Pulse Width:	TTL (into 50 ohm). 50 ohm. 8 ns (period < 100 ns), 40 ns (100 ns ≤ - < 1 μs), 400 ns (period ≥ 1 μs).	TTL/ECL (into 50 ohm). 50 ohm. 4 ns (period < 100 ns), 40 ns (100 ns ≤ - < 1 μs), 400 ns (period ≥ 1 μs).

HP-IB Capability: All modes and parameters can be programmed. Talk mode for status, error messages, stored parameters.

Memory: 9 programmable locations*,
1 location for active operating state*,
1 location with fixed parameter set.

Capacity: 1 complete operating state per location.

*Battery back-up for power-off storage

General

Recalibration Period: 1 year.

Repeatability: Factor 2 better than specified accuracy.

Operating Temperature: 0°C to 50°C (Specifications apply from 20°C to 40°C. Accuracy derating factors for 0°C to 20°C and 40°C to 50°C).

Power: 115/230 Vac + 10%, -22%, 48-66 Hz; 675 VA max.

Weight: net 20.8 kg (46 lbs). Shipping 25 kg (55 lbs).

Size: 178 H x 426 x 530 mm D (7 x 16.8 x 20.9 in.)

Ordering Information

Price

	8160A	8161A
8160A/8161A Programmable Pulse Generator	\$11500	\$14940
Opt 001: Rear panel inputs and outputs	N/C	N/C
Opt 020: Second channel (Rate common)	\$6000	\$6590
Opt 907: Front handle kit (P/N 5061-0090)	\$40	\$40
Opt 908: Rack flange kit (P/N 5061-0078)	\$30	\$30
Opt 909: Opt 907, 908, combined (P/N 5061-0084)	\$65	\$65
Opt 910: Additional Operating Manual	\$120	\$150
HP-IB Cables: Refer to page 30		
08160-39910 Verification Software (8160A only).	\$120	—

PULSE & DATA GENERATORS

1 MHz–50 MHz Pulse/Function Generator

Model 8116A

353



- Sine, triangle, square, haversine functions and dc
- 1 MHz–50 MHz, 32 Vpp for all waveforms
- Variable (10 ns min) pulse width, 6 ns transitions

- Wide range of operating capability
- Self-prompting operating concept
- Error recognition and self test

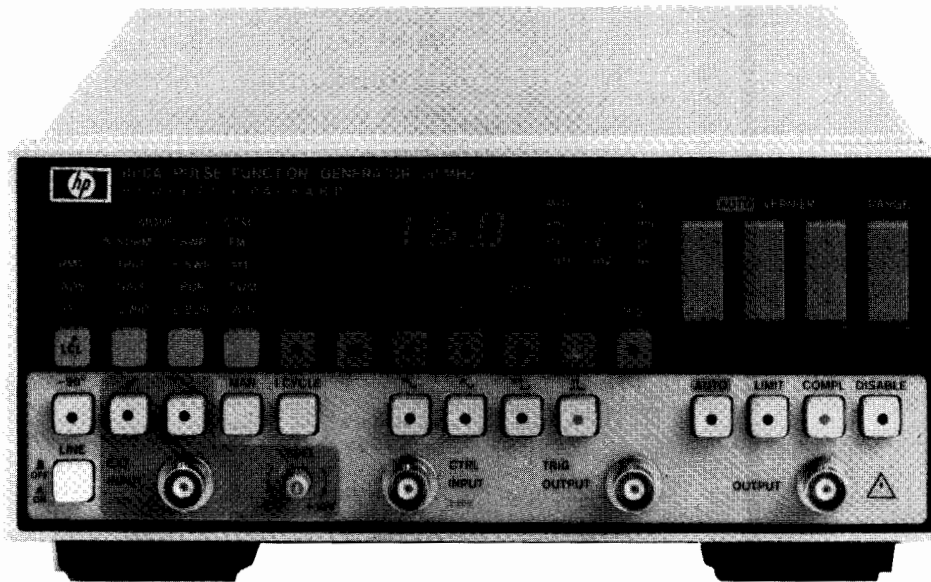

8116A
Option 001



The fully programmable 8116A features pulse as well as function generator capabilities in one small unit. A broad 1 MHz–50 MHz band for all waveforms and a wide choice of operating and modulating modes assure high flexibility. These factors, plus good repeatability, make the 8116A a sound, long-term investment.

Unique Operating Concept Saves Engineering Time

HP's custom IC's have made it feasible to put the many 8116A capabilities into such a small volume. Handling is simplified by a unique, microprocessor-controlled, operating concept which ensures a clear overview of the compact front panel at all times. When the mode and waveform have been selected, illuminated labels show which parameters must be set. There's no clutter, no confusion.

Auto vernier. In normal mode, the 8116A's auto-vernier increments any desired parameter continuously until a stop signal is applied. This means that thresholds can be measured automatically, without a controller.

Level or amplitude programming. The 8116A's output can be programmed in terms of high and low levels or in terms of amplitude and offset. Consequently a direct, automatic, conversion is always feasible so that the 8116A can be programmed in the same terms as the device is specified.

Safe limit. Devices can be protected by the limit feature. This prevents the output from exceeding a given magnitude.

Rectangular Waveforms

For applications such as laser diodes or dc motors, square waves can be programmed for constant duty cycles from 10% to 90%. For digital test, or for simulating very low duty-cycle events, pulse width can be programmed down to 10 ns. Square wave and Pulse modes provide clean 6 ns edges that are ideal for many technologies. Pulse width modulation and pulse recovery capability are available in Pulse mode.

Sine and Triangle Functions

10% to 90% duty cycle, programmable in 1% steps, provides ramps and asymmetrical sine waves for testing VCO's, servos, amplifier linearity and industrial process control systems. Haversine functions,

available in External Trigger, Gate and Burst modes, extend the applications to areas such as telephone line and vibration testing.

Modulation

All waveforms can be amplitude or frequency modulated. VCO operation allows frequency variation over two decades with an external voltage; consequently transducer output can be conditioned for mag tape recording, or frequency-shift keying or linear sweep can be carried out.

Option 001

10 1/2-decade log sweep. Sweep mode covers the wide 1 MHz–50 MHz band in a single up sweep. Test setups require no more than an X-Y recorder or scope because all necessary control signals are available. The 8116A sweeps can be internally triggered, if desired.

Accurate, counted bursts. A preprogrammed number of cycles of any waveform can be generated in Burst mode. With sine, triangle and square functions, bursts can be triggered internally as well as externally.

Hold capability. For material stress testing, low frequency functions can be held at instantaneous levels. Hold is controlled by an external signal.

Low-Cost Automation for Bench and Systems

Powerful capability, small size and wide specified temperature range make the 8116A a good choice for automatic test systems. Also, the low cost means that it's now realistic to automate those routine bench jobs and leave more time for design. Comfortable software features such as easy syntax and flexible format contribute to rapid system design.

Operating Confidence

There's reliance in the 8116A's output because proper operation is always ensured by the instrument's error detector. This helps the user to recover from an incorrect front panel or programming operation by indicating the offending parameter. Also, the built-in test and diagnosis feature verifies correct function each time the instrument is switched on.



PULSE & DATA GENERATORS

1 MHz–50 MHz Pulse/Function Generator

Model 8116A (Cont.)

Specifications

Specifications apply with 50-ohm load and temperatures in the range 0°C to 55°C.

Functions

Sine, triangle, ramp, square, pulse, haversine, havertriangle, dc.

Timing

Frequency

Range: 1 MHz to 50 MHz (3-digit resolution).
Accuracy¹ (pulse mode, 50% d/c): $\pm 3\% \pm 0.3$ MHz below 100 kHz, $\pm 5\%$ above 100 kHz.
Jitter (pulse mode, 50% d/c): $< 0.1\% + 100$ ps.
Stability: $\pm 2\%$ (1 hour), $\pm 5\%$ (24 hours).
Duty Cycle: (sine, triangle, square, haversine, havertriangle).
Range: 10% to 90% (20% to 80% above 1 MHz), 2-digit resolution.
Accuracy¹: ± 0.5 digits (± 3 digits above 1 MHz).

Pulse Width

Range: 10.0 ns to 999 ms (3-digit resolution).
Accuracy¹: $\pm 5\% \pm 2$ ns.
Jitter: $< 0.1\%$ ($0.2\% + 200$ ps for width ≤ 10 μ s).

Output Characteristics

(Voltages double into high impedance).

Amplitude

Range: 10.0 mVpp to 16.0 Vpp (3-digit resolution).
Accuracy¹: $\pm 5\%$ (at 1 kHz for sine and triangle).
Flatness (sine): $\pm 3\%$ ($\pm 5\%$ above 1 MHz, $+5$ – 15% above 10 MHz).
Flatness (triangle): $\pm 3\%$ ($\pm 5\%$ above 1 MHz, $+5$ – 25% above 10 MHz).

Offset and dc Mode

Range: 0.00 to ± 7.95 V (0 to ± 795 V mV for amplitude < 100 mVpp).
Resolution: 3 digits.
Accuracy¹: 0.5% of setting $\pm 1\%$ of ampl ± 40 mV ($+2$ mV if ampl < 100 mVpp, ± 20 mV in dc mode).

Distortion (Sine, normal mode, 50% duty cycle).

Total harmonic distortion (10 Hz–50 kHz): $< 1\%$ (-40 dB), may increase by 3 dB at 0 and 55°C.

Harmonic related signals (50 kHz–1 MHz): < -34 dB,
(1 MHz–50 MHz): < -23 dB.

Non-linearity (triangle, ramp, 100 mHz–1 MHz):

$< \pm 3\%$.

Pulse and Square Wave Characteristics

Transitions: < 6 ns.
Pulse perturbations: $< \pm 5\% \pm 2$ mV.
Output impedance: 50 ohm $\pm 5\%$.

Modes

Normal, trigger*, gate*, external width.

Additional Modes in 8116A Option 001

Logarithmic Sweep (for all waveforms).

Range: Start and stop frequencies selectable up to full range (1 MHz–50 MHz).

Sweep time: selectable in 1-2-5 sequence from 10 ms to 500 seconds per decade.

Sweep repetition: continuous sweeps (internal sweep) or externally triggered.

Counted Burst* (for all waveforms).

Burst length: 1 to 1999 cycles.

Burst repetition: internally triggered at selectable intervals from 20 ns to 999 ms (except in Pulse mode), or externally triggered.

*Selectable (-90°) start-phase for haversine, havertriangle.

Control Modes

Frequency modulation: $\pm 5\%$ max deviation.

Sensitivity: 1 V for 1% deviation.

Modulating frequency: dc to 20 kHz.

Amplitude Modulation

Sensitivity: ± 2.5 V for 100% mod. ($+2.5$ V to -7.5 V for DSBSC).

Modulating frequency: dc to 1 MHz.

¹Applies from 15°C to 35°C. Derating factor outside this range is $1 + 0.05\%$ per °C.

Pulse Width Modulation

Range: 10 ns to 1 s in 8 non-overlapping decade ranges. Max. width ratio: 10:1.

Sensitivity: ± 6 V for 10:1 ratio.

Voltage-Controlled Oscillator

Range: 2 decades in range 1 MHz–50 MHz.

Sensitivity: 0.1 V to 10 V for 2 decades.

Modulating frequency: dc to 1 kHz.

Auxiliary Modes

Manual: simulates external input.

1 Cycle (Option 001): triggers single output cycle in Trigger, Gate and Ext Burst modes.

Auto Vernier: continuous vernier which can be remotely or manually stopped.

Limit: programmable maximum output levels to protect DUT.

Complement: selectable normal/complement output.

Disable: relay disconnects output.

Auxiliary Inputs and Outputs

External Input

Threshold: ± 10 V adjustable.

Max input voltage: ± 20 V.

Sensitivity: 500 mVpp.

Min pulse width: 10 ns.

Input impedance: 10 k Ω typ.

Trigger slope: positive, negative and off.

Control Input

Max input voltage: ± 20 V.

Input impedance: 10 k Ω typ.

Trigger Output

Output levels: 0/2.4 V typ.

Output impedance: 50 ohm typ.

X-Output (Option 001) for sweep X-Y recording (rear panel).

Output levels: 0 V (= start frequency) to 10 V max.

Slope: 1.5 V per sweep decade.

Marker Output (Option 001) for sweep (rear panel).

Output levels: TTL

Leading edge: positive at selected marker frequency.

Hold Input (Option 001), rear panel.

Input levels: TTL

Leading edge: positive transition causes 8116A output ($f < 10$ Hz) to hold at instantaneous level. Output droop 0.01% per second.

Max input voltage: ± 20 V

HP-IB Capability:

All manual key operations are programmable. Talk mode provides learn, status byte and error report capabilities.

Memory:

Battery-backup RAM retains current operating state.

General

Repeatability: factor 4 better than accuracy.

Environmental

Storage temperature: -40°C to $+65^\circ\text{C}$.

Operating temperature: 0°C to 55°C .

Humidity: 95% RH, 0°C to 40°C .

Power: 100/120/220/240 V rms; $+5\%$, -10% ; 48 to 440 Hz; 120 VA max.

Weight: net, 5.9 kg (13 lb). Shipping, 8.0 kg (18 lb).

Size: 89 H x 212.3 W x 422 mm D (3.5 x 8.36 x 16.6 in.)

Ordering Information

8116A Programmable Pulse/Function Generator \$3440

Opt 001: Burst and Logarithmic Sweep add \$430

Opt 910: Extra Operating & Service Manual add \$48

5061–2001: Bail Handle Kit \$25

5061–0072: Rack Mount Kit (single 8116A) \$50

5061–0074: Rack Mount Kit (two instruments) \$20

5061–0094: Lock Link Kit (for use with 5061–0074) \$42

Prices

PULSE & DATA GENERATORS

50 MHz Programmable Signal Source

Model 8165A

355



- Pulse/function capability
- Sine, triangle, square to 50 MHz
- Pulses and ramps to 20 MHz

- Trigger, gate and counted burst
- Synthesizer stability, precision amplitude
- Storage of operating parameters

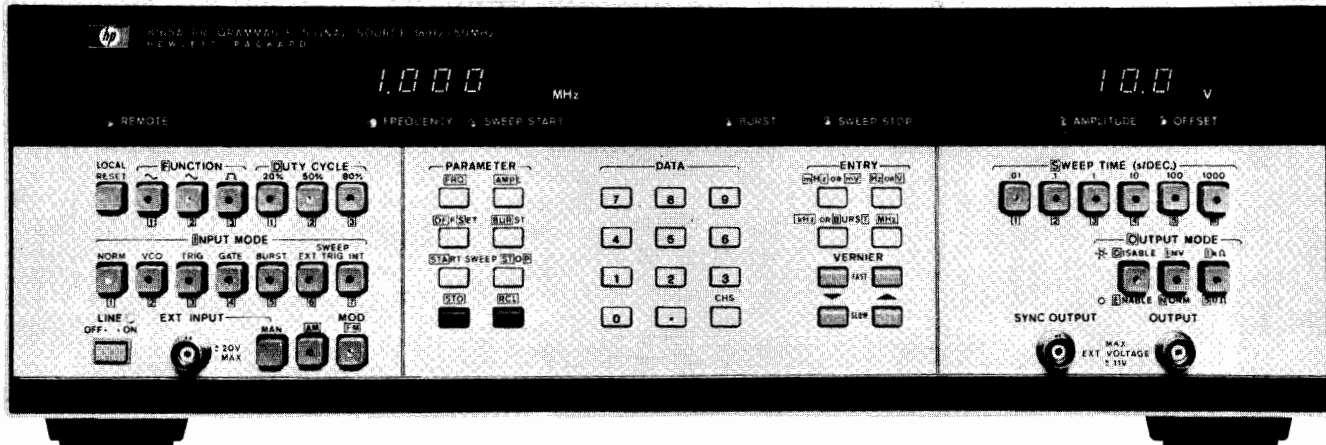

8165A Option 002

Versatility and Simplicity for Systems and Bench

The 8165A Programmable Signal Source is a versatile function generator with good accuracy and many trigger features. Micro-processor control assures rapid, accurate setup whether programming locally or via HP-IB.

Operating Set Storage

Ten complete sets of operating information can be stored and recalled. In the event of power failure, battery back up retains all data plus the active settings.

Stability and Resolution

Very stable frequency is ensured with phase lock loop techniques and internal crystal reference. The four-digit frequency display means a 1 μ Hz resolution in the 1 to 9.999 MHz range.

Specifications

Waveforms and Frequency Range

Sine, Square, Triangle (50% duty cycle): 1.000 MHz to 50.00 MHz.

Pulse/Ramp (20, 80% symmetry): 1.000 MHz to 19.99 MHz.

Haversine/havertriangle: inquire for special option.

Output Characteristics

Range: amplitude and offset independently variable within ± 10 V window.

Source impedance: selectable 50 Ω $\pm 1\%$ or 1 k Ω $\pm 10\%$

Amplitude: 10.0 mVpp to 10.0 Vpp (50 Ω into 50 Ω)
2.00 Vpp to 20.0 Vpp (1k Ω into 50 Ω)

Accuracy: (sine, square) $\pm 2\%$, $\pm 5\%$ above 5 MHz

Offset: 0 ± 10 mV to ± 5.00 V (50 Ω into 50 Ω)
0 ± 20 mV to ± 10.0 V (1k Ω into 50 Ω)

Accuracy: $\pm 1\%$ programmed value $\pm 1\%$ signal Vpp ± 20 mV.

Sine characteristics

Distortion: total harmonic distortion (THD) for fundamental up to 1 MHz: $\pm 1\%$.

Harmonic signals: (fundamental 1-10 MHz): ≤ -36 dB

Harmonic signals: (fundamental above 10 MHz): ≤ -30 dB.

Non-harmonic: ≤ -40 dB.

Square/Pulse Characteristics

Transition times: (10% to 90%): ≤ 5 ns (50 Ω into 50 Ω), ≤ 7 ns (1 k Ω into 50 Ω)

Preshoot/overshoot/ringing: $\leq \pm 5\%$ (50 Ω into 50 Ω), $\pm 10\%$ (1k Ω into 50 Ω).

Triangle/ramp characteristics

Linearity: (10% to 90%): $\leq \pm 1\%$ ($\leq \pm 5\%$ above 5 MHz).

Operating Modes

Norm (continuous phase locked), **VCO** (external sweep voltage),

Trig (ext or man. one-shot), **Gate**, **Burst** (1-9999 counted cycles),

Frequency modulation.

HP-IB: control and learn capability for all modes and parameters.

General

Memory: non volatile. 10 addressable locations plus one for active operating state. Each location can store a complete set of operating parameters and modes.

Power: 100/120/220/240 Vrms; $\pm 5\%$, -10% ; 48 to 66 Hz, 200 V A max.

Operating temperature: 0 $^\circ$ to 50 $^\circ$ C

Weight: net 12 kg (26.5 lbs). Shipping 16 kg (35.3 lbs).

Size: 133 H \times 426 W \times 422 mm D (5.2" \times 16.8" \times 16.6").

Ordering Information

8165A Programmable Signal Source*

Opt 002: Logarithmic Sweep and AM

Opt 003: Rear Panel Connectors

Opt 907: Front Handle Kit (Part No 5061-0089)

Opt 908: Rack Mounting Kit (Part No 5061-0077)

Opt 909: Opt 907, 908 combined (Part No 5061-0083)

Opt 910: additional Operating and Service Manual

*HP-IB cables not supplied, see page 30.

Price

\$6810

add \$880

N/C

add \$32

add \$25

add \$55

add \$70

PULSE & DATA GENERATORS

High Resolution Time Synthesizer

Model 5359A

- Precise digital delays 0-160 ms
- Jitter < 100 ps
- Increments 50 ps
- Programmable
- Fully synchronous to external trigger
- Automatic Calibration

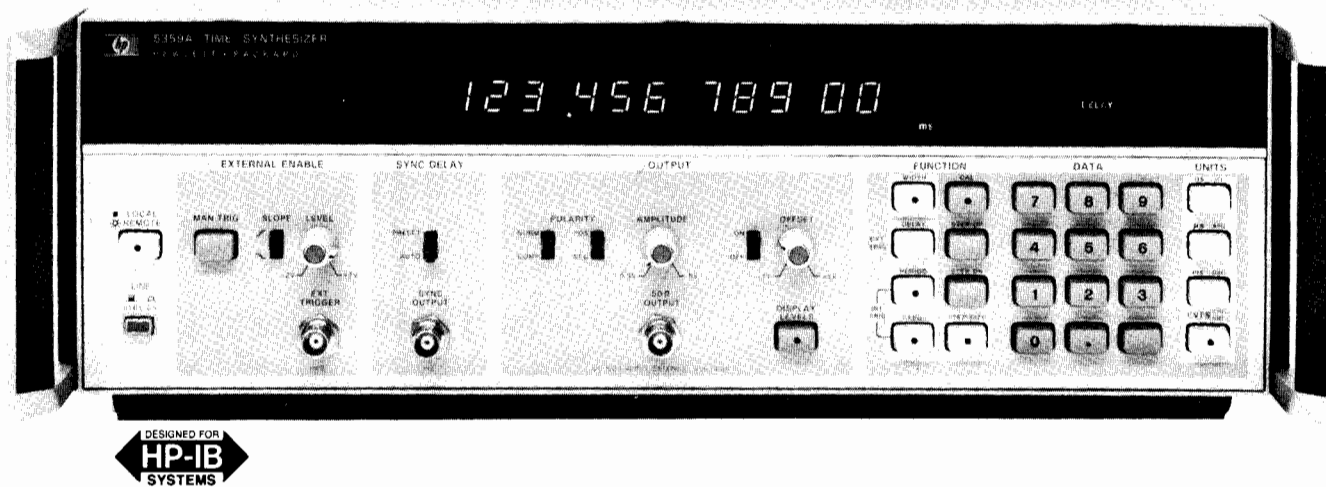

The 5359A Time Synthesizer produces two extremely precise, low jitter time delays. These delays, T_d and T_w , are individually selectable by means of the keyboard, in 50 ps or greater steps to generate delays of up to 160 ms.

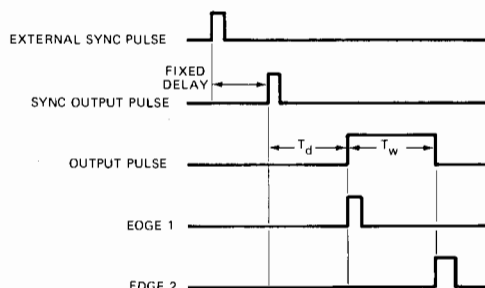

The 5359A has many applications and may be used for the calibration of Radar, Loran, DME and Tacan Systems, or for precision generation of delayed sweeps in oscilloscopes, and for extremely accurate "time positioning" control of external gates on frequency counters. In component and circuit test, the instrument may be used for extremely accurate delay line simulation.

Specifications

Modes

External trigger mode: the delays from the sync out to the beginning of the output pulse, and the width of the output pulse, are selected.

Internal trigger mode: the "period" or "frequency", and the width of the output pulse, are selected.

Range

Delay T_d : 0 ns to 160 ms.

Width T_w : 5 ns to 160 ms (width & delay \leq 160 ms).

Period: 100 ns min. or width + 80 ns, 160 ms max.

Frequency: same as corresponding "period".

Repetition rate: 10 MHz max.

Accuracy: ± 1 ns \pm time base error.

Insertion delay: fixed at < 150 ns; selectable as < 50 ns for delays > 100 ns.

Jitter: typical 100 ps rms; maximum 200 ps rms

External trigger input: -2 V to + 2 V slope selectable.

Sync output: 1 V - 50 Ω ; 5 V - 1M Ω . Width 35 ns nominal.

Output pulse

Amplitude: 0.5 V to 5 V into 50 Ω .

Polarity: positive or negative.

Offset: -1 V to 1 V, or OFF.

Transition time: < 5 ns.

External voltage must not be applied. Offset and Amplitude voltage into 50 Ω may be displayed.

EDGE 1 OUTPUT (rear panel): occurs in Sync with leading edge of output pulse (same spec. as Sync out).

EDGE 2 OUTPUT (rear panel): occurs in Sync with falling edge of output pulse (same spec. as Sync out).

Events mode: substitutes external input (to 100 MHz) for the internally counted clock (Delay and width must both be specified in events and not time).

Triggered frequency mode: the same as internal frequency mode except the output is a burst beginning in synchronism with an external trigger signal, and continues for the duration of this signal.

Calibrate mode: performs an internal calibration to remove the effects of internal delay differences.

External probes: provides outputs to control the 5363B probes and accepts inputs from the probes to include external devices in the calibration loop.

HP-IB: All controls except trigger levels are programmable as standard. HP-IB cable not included, see page 30.

Time base (10811A High Stability Oven Oscillator)

Frequency: 10 MHz

Aging: $< 5 \times 10^{-10}$ /day

Temperature: $< 2.5 \times 10^{-9}$, 0°C to 50°C

Line voltage: $< 1 \times 10^{-10}$, $\pm 10\%$ from nominal

Size: 146.1 H \times 425.5 W \times 520.7 mm D (5.25" \times 16.75" \times 20.50").

Weight: 30 lbs.

Power requirements: 100, 120, 220, or 240 Vac +5% -10%, 48 to 66 Hz, less than 250 VA

Front handles: supplied with instrument.

Options and Accessories

908: Rack Flange Kit for use w/o handles

913: Rack Flange Kit for use with supplied handles

10870A: Service Kit

5359A Time Synthesizer

Price

add \$31

add \$25

add \$450

\$8750

PULSE & DATA GENERATORS

Fast, High Power Pulse Generator

Model 214B

357



- High power 100 V, 2 A output
- 10 MHz repetition rate

- Constant duty cycle
- Counted pulse burst option

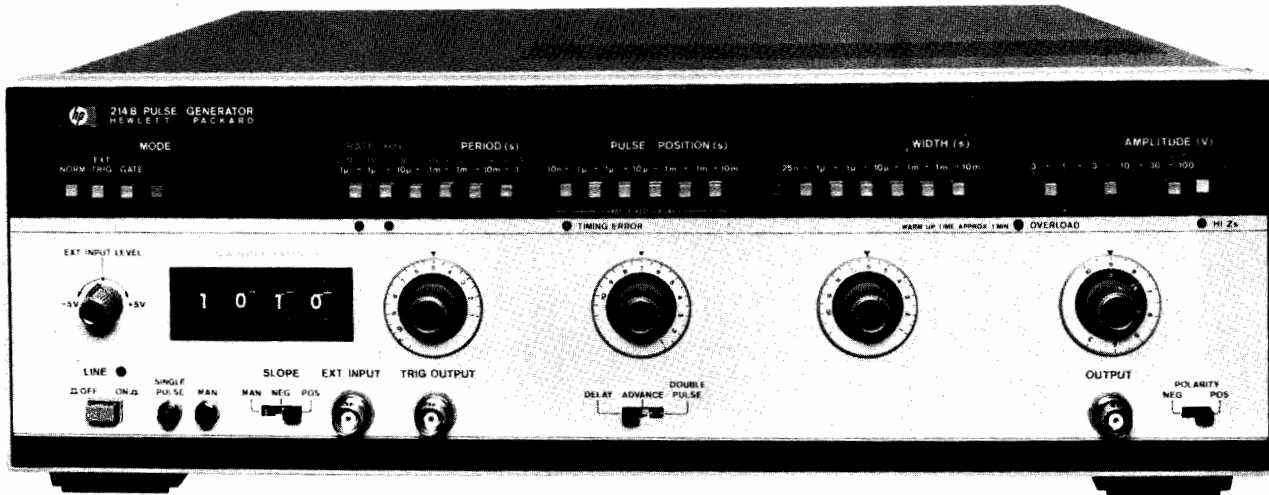

214B Option 001

The HP 214B pulse generator employs semiconductor technology for high power pulse generation at up to 10 MHz repetition rate. Delivering 100V pulses with 15 ns risetimes, the 214B meets the speed demands of today's applications.

State-of-the-art VMOS FETS used as current sources for the output amplifier tubes enable pulse width to be specified down to 25 ns. The 214B is thus well-equipped for low duty cycle applications such as laser diode pulsing or transient simulation.

Where changing duty cycle threatens destruction to the device under test, the 214B Constant Duty Cycle (CDC) mode provides device protection. In CDC operation the duty cycle, hence power, remains constant as frequency is varied. The 214B is itself protected against excessive duty cycles via an overload protect circuit.

Easy operation is assured by the timing error indication. Calibrated dials enable fast accurate adjustments. Operating into unmatched loads, clean pulse shape is guaranteed by the low reactance 50 Ω source impedance. Pulse distortions such as preshoot and overshoot are specified as 5% at all amplitudes.

Specifications

Timing

Repetition rate: 10 Hz to 10 MHz in 6 ranges. In 30V - 100V amplitude range, maximum rep. rate is 4 MHz. Calibrated vernier provides continuous adjustment within ranges. **Vernier accuracy:** \pm (10% of setting + 1% full scale). **Period Jitter:** \leq 0.1% + 300 ps.

Pulse delay/advance: pulse can be delayed/advanced with respect to the trigger output from 10 ns to 10 ms (\pm fixed delay of 45 ns) in 5 ranges. Calibrated vernier provides continuous adjustment within ranges. **Vernier accuracy:** \pm (10% of setting + 1% full scale) + fixed delay. **Position Jitter:** \leq 0.1% + 500 ps

Maximum pulse position duty cycle: \geq 50%

Double pulse: 5 MHz maximum in all ranges except 30V - 100V range which is max. 2 MHz. Minimum separation is 100 ns.

Pulse width: 25 ns to 10 ms in 6 decade ranges. Calibrated vernier provides continuous adjustment within ranges. **Accuracy:** \pm (10% of setting + 1% full scale) + 5 ns. **Width Jitter:** \leq 0.1% + 500 ps.

Max. duty cycle: \geq 10% for 30 - 100V range. \geq 50% all other ranges.

Constant duty cycle mode (disabled in ext. trigger mode): duty cycle of output pulse remains constant as the period is varied. The duty cycle limits in this mode are typically 8% fixed for the 10 M - 1 MHz range (max. 4 MHz); 2.5% to 10% for 1 MHz - .1 MHz range; .25% to 10% for .1 MHz - 10 kHz range; 0.1% for all other ranges. Calibrated vernier provides continuous adjustment within ranges.

Accuracy: \pm (15% of setting + 1% of full scale).

Trigger output:

Amplitude: \geq +5 V (50 ohm into open circuit).

Pulse width: 10 ns typical.

Externally Controlled Operation

External Input (Impedance 10 k ohm, dc Coupled)

Repetition rate: dc to 10 MHz. **Sensitivity:** 500 mVpp, dc coupled.

Slope: pos. or neg. **Trigger level:** +5 V to -5 V adjustable.

Maximum input level: \pm 100 V. **Trigger pulse width:** \geq 10 ns.

EXT TRIG mode: An output pulse is generated for each input pulse. **GATE mode:** gate signal turns on rep. rate generator synchronously. Last pulse always completed.

BURST mode (optional): preselected number of pulses generated on receipt of trigger signal. **Number of pulses:** 1 to 9999. Minimum spacing between bursts: 200 ns.

Manual: pushbutton can be used for triggering single pulses (EXT TRIG mode), generating gate signals (GATE mode) or triggering pulse bursts (BURST mode).

Output

Amplitude: 0.3 V to 100 V in 5 ranges. Calibrated vernier provides adjustment within ranges. **Vernier accuracy:** \pm 10% of setting.

Source impedance: fixed 50 Ω nominal on ranges up to 10 V. Selectable 50 Ω nominal or HI-Z on 10 - 30 - 100 V ranges (with 50 Ω / 50 Ω impedance, amplitude decreases to 5 - 15 - 50 V).

Polarity: pos. or neg. selectable.

Transition times: \leq 15 ns for leading and trailing edges.

Pulse top perturbations: \leq \pm 5% of amplitude.

General

Operating temperature: 0°C to 55°C.

Power: 100/120/220/240 Vrms; +5%, -10%, 48 to 66 Hz, 360 VA max.

Size: 133 mm H x 426 mm W x 422 mm D (5.2" x 16.8" x 16.6")

Weight: net 13.6 kg (30 lb), shipping 15.6 kg (34.3 lb).

Ordering Information

214B Pulse Generator

Opt 001: Counted Burst add \$440

Opt 907: Front Handle Kit (part number 5061-0089). add \$32

Opt 908: Rack Mount Kit (part number 5061-0077). add \$25

Opt 909: Opt 907, 908 Combined (part number 5061-0083). add \$55

Opt 910: extra Operating and Service Manual add \$33

Prices

\$3735



PULSE & DATA GENERATORS

20 MHz Pulse Sources

Models 8005B, 8011A

- Dual outputs, +10 V and -10 V
- TTL output
- Gating, square wave, double pulse modes

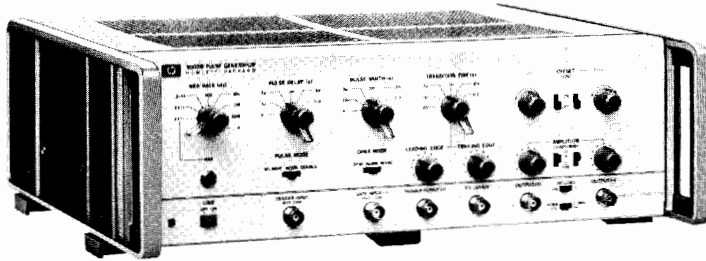

8005B

The 8005B is a general purpose, triple output pulse generator. This instrument has all parameters variable and produces simultaneous pos. and neg. pulses. It also has a TTL output with all parameters variable except amplitude. This feature, together with the normal/complement facility, greatly improves the ease of operation.

8005B Specifications

Pulse Characteristics

Transition times: ≤ 10 ns to 2 s. Edges independently variable.
Non-linearity: for transition times > 30 ns, $< 4\%$ of pulse amplitude.
Preshoot, overshoot, ringing: $< 5\%$ of pulse amplitude.
Pulse width: < 25 ns to 3 s. **Jitter:** $< 0.1\%$ of setting + 50 ps.
Max. duty cycle: $> 80\%$ (0.3 Hz - 1 MHz), $> 50\%$ (1-20 MHz).
Square wave: 0.15 Hz - 10 MHz.
Pulse delay: < 100 ns to 3 s. **Jitter:** $< 0.1\%$ of setting + 50 ps.
Pulse outputs: simultaneous pos., neg. and TTL outputs.
Pulse amplitude: 300 mV to 10 V.
Output protection: max. external voltage ± 10 V.
Source impedance: 50 ohms $\pm 10\%$ or high impedance selectable.
TTL compatible output: +4.6 V norm. or comp. 50 Ω impedance.

Repetition Rate and Trigger

Repetition rate: 0.3 Hz to 20 MHz in 5 ranges. **Jitter:** $< 0.1\%$ + 50 ps.
Double pulse: 10 MHz max. Simulates 20 MHz.
Trigger output: $> +2$ V ampl. across 50 ohms. **Width:** > 6 ns.

Externally Controlled Operation

External triggering (dc to 20 MHz)

Delay: approx. 35 ns trig. input to trig. output.
Maximum input: ± 10 V. **Sensitivity:** sine 2 Vpp.
Impedance: approx. 1 k ohms, dc coupled. **Pulses:** ± 1 Vpeak.
Input pulse width: ≥ 10 ns.

Gating

Synchronous: gate signal turns on repetition rate. Last pulse is always completed.
Asynchronous: gate signal controls output of rate generator.
Gate input (impedance 1 k ohms dc coupled).
Amplitude: 2 V to 20 V (max.). **Polarity:** negative.

General

Operating temperature: 0°C to 55°C.
Power: 115/230 Vrms; +10%, -15%; 48 to 440 Hz, 180 VA max.
Weight: net 7 kg (15.5 lb). Shipping 9 kg (20 lb).
Size: 130 H x 426 W x 290 mmD (5.1" x 16.8" x 11.4").

Ordering Information 8005B, 8011A

8011A Pulse Generator	\$875
Opt 001: Pulse Burst	add \$350
Opt 910: extra Operating and Service Manual	add \$20
15179A (for 8011A): Adapter frame, Rack mount for 2 units.	\$195
8005B Pulse Generator.	\$2470
Opt 908: Rack Flange Kit (part number 5060-8740).	add \$22
Opt 910: extra Operating and Service Manual.	add \$28

Price

- Repetition rate 0.1 Hz to 20 MHz
- Positive/negative/symmetrical output
- Normal/complement switch



8011A Option 001

The 8011A is a versatile, reliable, low cost pulse generator. This compact instrument features an uncomplicated design using high quality components to ensure long, dependable service. Ease of operation results from the logical and simple front panel layout. These qualities and the many pulse formats available emphasize the Model 8011A's cost-effectiveness in a wide application range.

8011A Specifications

Pulse Characteristics (50 ohm Source/Load Impedances)

Transition times: < 10 ns fixed.
Overshoot, ringing and preshoot: $< \pm 5\%$ of pulse amplitude. May increase to 10% at counter-clock wise positions of amplitude vernier.
Pulse width: 25 ns to 100 ms in four ranges. Vernier provides continuous adjustment within each range.
Width jitter: $< 0.1\%$ + 50 ps on any width setting.
Maximum duty cycle: $> 50\%$ (100% using pulse complement)
Maximum output: 8 V. With internal 50 Ω and external Hi-Z or internal Hi-Z/external 50 Ω , then 16 V max.
Attenuator: 3-step attenuator provides the ranges 0.25 V - 1 V - 4 V - 16 V. Vernier provides continuous adjustment within each range.
Source impedance: 50 Ω $\pm 10\%$ shunted by 30 pF, except in 4 V - 16 V range which is 50 Ω /Hi-Z, switch selectable.
Polarity/Format: pos., neg., or sym./norm. or compl., switch select.

Repetition Rate and Trigger

0.1 Hz to 20 MHz in 5 ranges. Vernier provides continuous adjustment within each range. **Period jitter:** $< 0.1\%$ + 50 ps of per. setting.
Square Wave: 0.05 Hz to 10 MHz.
Trigger output: dc coupled 50 Ω (typ.) source delivering $\geq +1$ V into 50 Ω (can increase to +5 V). **Trigger pulse width:** 20 ns ± 10 ns.

Externally Controlled Operation

Input impedance: 50 Ω $\pm 10\%$. **Trigger polarity:** positive.
Maximum input: ± 5 V. **Sensitivity:** 1 V.
Manual: front panel pushbutton for generating single pulse.
Repetition rate: 0 to 20 MHz. In square wave, output frequency is half the input frequency.
Trigger source: manual or ext. signal. Min. ext. signal width 20 ns.
Pulse burst mode (option 001): preselected number of pulses generated on receipt of trigger.
Burst trigger source: man. or ext. signal. Min. signal width 25 ns.

General

Operating temperature: 0°C to 55°C.
Power: 100/120/220/240 Vrms; +5%, -10%; 48 Hz to 440 Hz, 70 VA max.
Weight: net, 4 kg (9 lb). Shipping, 6.5 kg (14.6 lb).
Dimensions: 126 H x 200 W x 280 mmD (5" x 7.9" x 11")

PULSE & DATA GENERATORS

1 Hz–20 MHz Pulse/Function Generator

Model 8111A



- Sine, triangle, square, haverfunctions
- 20 MHz, 32 Vpp for all waveforms
- Variable duty cycle or pulse width

- Trigger, gate, VCO and optional burst
- Digital display for all parameters
- Error recognition

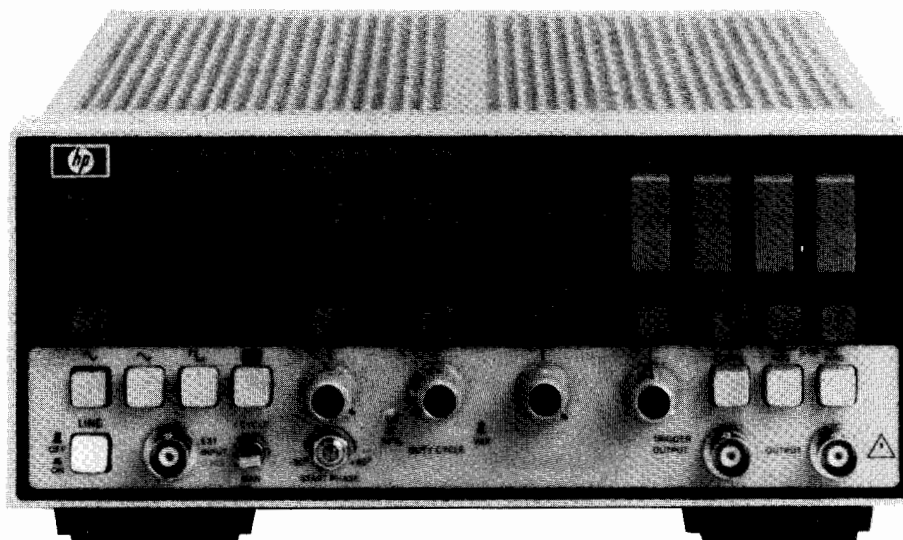

8111A Option 001



The 8111A combines pulse generator and function generator capabilities in a single, compact unit. Triggered operation for all waveforms, and the ability to define rectangular waveforms in terms of pulse width or duty cycle, are examples of the 8111A's versatility.

Saves Space and Equipment

Small size and manifold capability make the 8111A an ideal source for service and bench. Digital display, error detector and good repeatability assure high operating confidence. This reduces the need for output monitoring and consequently saves equipment.

Flexible

Operating modes include VCO which permits frequency-shift keying and dc-to-frequency conversion as well as sweep and FM applications. Option 001's Burst mode simplifies tone burst generation and digital preconditioning by generating a precise number of waveform cycles. An "extra cycle" feature activated after a burst allows critical events to be examined.

Pulse mode's variable width down to 25 ns and clean 10 ns transitions provide useful digital test capability. High analog flexibility is assured because all waveforms can be generated in trigger, gate and burst modes. Adjustable duty cycle up to 999 kHz means that CRT sawtooth waveforms and rectangular signals for dc motor control can be simulated.

Specifications (50-ohm load resistance)

Waveforms:

sine, triangle, ramp, square, pulse, haverfunctions.

Timing

Frequency

Range: 1.00 Hz to 20.0 MHz (3-digit resolution).

Accuracy (50% duty cycle): 5% ($\pm 10\%$ below 10 Hz).

Jitter: $< 0.1\% + 50$ ps.

Stability: $\pm 0.2\%$ (1 hour), $\pm 0.5\%$ (24 hours).

Duty Cycle (sine, triangle, square, haverfunctions):

	Calibrated	Variable (below 1 MHz)
Range:	50% nominal	10% to 90%.
Resolution:	2 digits	2 digits.
Accuracy:	± 1 digit	± 6 digits (± 3 in range 20 to 80%).

Pulse Width

Range: 25.0 ns to 100 ms (3-digit resolution).

Accuracy: $\pm 5\% \pm 2$ ns.

Output Characteristics

(voltages double into high impedance)

Amplitude

Range: 1.60 mVpp to 16.00 Vpp ($3\frac{1}{2}$ digit resolution).

Accuracy: $\pm 5\%$ (at 1 kHz for sine and triangle).

Flatness (sine, triangle): $\pm 3\%$ ($+10\%$, -15% above 1 MHz).

Offset

Range: 0.00 mV to ± 8.00 V (3-digit resolution).

Accuracy: $\pm 0.5\%$ setting $\pm 1\%$ ampl ± 20 mV

(ampl ≥ 160 mVpp),

$\pm 0.5\%$ setting $\pm 1\%$ ampl ± 1 mV

(ampl < 160 mVpp).

Distortion: THD $< 1\%$ (-40 dB) below 100 kHz, $< 3\%$ (-30 dB) above 100 kHz; may increase by 3dB at 0°C and 55°C .

Linearity (triangle): $< \pm 3\%$ ($< \pm 1\%$ below 1 MHz)

Pulse and Squarewave Performance

Transitions: < 10 ns.

Perturbations: $< \pm 5\%$ ($< \pm 10\%$ below 0.16 Vpp).

Output impedance: 50 ohm $\pm 5\%$.

Modes:

normal, trigger*, gate*, VCO and (Option 001) burst*.

*Adjustable start-phase for haversine, havertriangle

VCO range: 2 decades, ext. signal 0.1 V to 10 V (dc to 1 kHz).

Burst length: 1 to 1999 periods for all waveforms.

General

Repeatability: factor 2.5 better than accuracy.

Environmental

Storage temperature: -40°C to $+75^\circ\text{C}$.

Operating temperature: 0°C to 55°C .

Humidity: 95% RH, 0°C to 40°C .

Power: 100/120/220/240 V rms; $+5\% - 10\%$; 48 to 440 Hz; 70 VA max.

Weight: net, 4.6 kg (10 lb). Shipping, 6.6 kg (15 lb).

Size: 89 H x 212.3 W x 345 mm D (3.5 x 8.36 x 13.6 in).

Ordering Information

8111A Pulse/Function Generator

Price

\$1775

Opt 001: Burst

add \$375

Opt 910: Extra Operating and Service Manual

add \$20

5061-2001: Bail Handle Kit

\$25

5061-0072: Rack Mount Kit (single 8111A)

\$50

5061-0074: Rack Mount Kit (two instruments)

\$20

5061-0094: Lock Link Kit (for use with 5061-0074)

\$42

PULSE & DATA GENERATORS

50 MHz Pulse Sources

Models 8012B & 8013B

- Variable transition times down to 5 ns
- ± 10 V amplitude; selectable source impedance
- Ideal for testing TTL

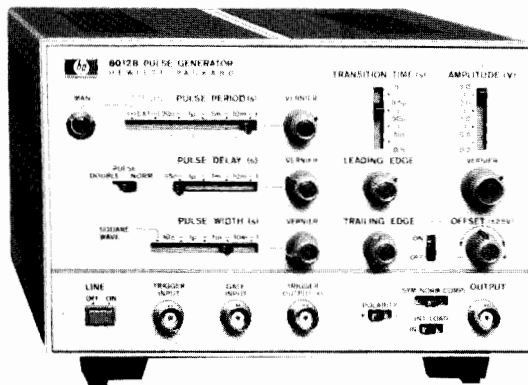

8012B

- Fixed 3.5 ns transition times
- 10 V amplitude; selectable source impedance
- 2 outputs

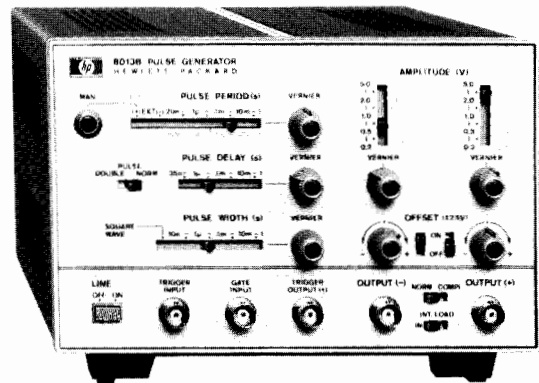

8013B

The 8012B and 8013B are at the top of their class for versatility, ease of operation and wide range of application. They provide the ideal solution to almost all digital logic testing problems with fixed 3.5 ns transition times on the 8013B and variable transition times down to 5 ns on the 8012B. The well-composed layout of the front panel controls (horizontal controls for horizontal parameters, vertical controls for vertical parameters) enables output pulses to be set up quickly and accurately with minimum risk of incompatible settings. Both models feature normal and complement outputs and a switchable internal 50 ohm source.

Specifications

Pulse Characteristics

Parameter	8012B		8013B	
	Int. load IN	Int. load OUT	Int. load IN	Int. load OUT
Transition times	5 ns—0.5s 4 ranges. Verniers provide separate control of both edges within ranges up to max. ratios of 100:1 or 1:100.	6 ns—0.5s	3.5 ns fixed	5 ns fixed
Source impedance	50 ohms $\pm 10\%$ shunted by typically 20 pF	>50 ohms	50 ohms $\pm 3\%$ shunted by typically 20 pF	>50 ohms

Parameter	8012B/8013B	
	Internal load IN	Internal load OUT
Overshoot ringing	$\pm 5\%$ of pulse amplitude	May increase to $\pm 10\%$ when amplitude is between 0.4—4 V
Maximum output	5 V across 50 ohms. 10 V across open circuit. Short cct. protection.	10 V across 50 ohms. Short cct. protection.
Attenuator	4-step, reduces output to 0.2 V.	4-step, reduces output to 0.4 V.
DC offset	± 2.5 V across 50 ohms. Independent of amplitude settings.	DC offset switched off.

Linearity (8012B): for transition times > 30 ns, maximum straight line deviation is 5% of pulse amplitude.

Preshoot: $< \pm 5\%$ of pulse amplitude.

Pulse width: < 10 ns to 1 s in four ranges. Vernier provides continuous adjustment within ranges.

Width jitter: $< 0.1\% + 50$ ps on any width setting.

Maximum duty cycle: $> 75\%$ from 1 Hz to 10 MHz, decreasing to $\geq 40\%$ at 50 MHz. Up to 100% in COMPL mode.

Polarity: 8012B; positive or negative selectable, NORM/COMPL/SYM selectable; 8013B, one positive + one negative channel, NORM/COMPL selectable.

Pulse delay: < 35 ns to 1 s (with respect to trigger output) in four ranges; vernier provides continuous adjustment within ranges.

Delay jitter: $< 0.1\% + 50$ ps on any setting.

Repetition Rate and Trigger

1 Hz to 50 MHz in four ranges, continuous adjustment within ranges.

Period jitter: $< 0.1\% + 50$ ps on any rate setting.

Square wave: 0.5 Hz to 25 MHz in four ranges. Duty cycle 50% $\pm 5\%$ up to 1 MHz, tolerance increases to $\pm 15\%$ at 25 MHz.

Trigger output: $> +1$ V across 50 Ω , 16 ns ± 10 ns wide.

External Triggering

0 to 50 MHz; for square wave output, frequency divided by factor 2.

Trigger input: sine waves 1.5 V p-p (about zero) or pulses > 0.8 V either polarity, > 7 ns wide. Maximum input ± 7 V.

Impedance: 50 $\Omega \pm 10\%$, dc coupled.

Delay: 25 ns ± 8 ns leading edge trig. input to trig. output.

Manual: pushbutton for single pulse.

Gating

Synchronous gating: gating signal turns generator "on". Last pulse is completed even if the gate ends during pulse.

Gate input: dc-coupled; voltage at open connector approx. +1.8 V. Shorting current ≤ 12 mA. Input impedance $\approx 160\Omega$

Gate input signal: voltage $> +1.5$ V or resistor > 1 k Ω to ground enables rep. rate generator. Voltage $< +0.8$ V or resistor $< 160\Omega$ disables rep. rate generator. Input TTL compatible, max. ± 5 V.

External Width and RZ

External width: output pulse width determined by width of drive input signal. Amplitude, transition times selectable. Trigger output independent of external width input signal.

RZ mode: external drive input switched to delay generator. Period determined by period of drive input signal. Delay, amplitude and width selectable.

Input signal: $> +1$ V, > 7 ns wide. Max. ± 5 V. 50 Ω dc coupled.

General

Operating temperature: 0°C to 55°C.

Power: 100/120/220/240 V rms; +5%, -10%; 48 to 400 Hz, 100 VA max.

Weight: net, 4kg (8.8 lb). Shipping, 6.5 kg (14.6 lb).

Size: 126 H \times 200 W \times 280 mm D (5 \times 7.9 \times 11 in.)

Ordering Information

8012B Pulse Generator

Opt 910: extra operating and service manual

8013B Pulse Generator

Opt 910: extra operating and service manual

15179A Adapter frame. Rack mounting for two units

Prices

\$1500

add \$20

\$1300

add \$13

\$195

PULSE & DATA GENERATORS

50 MHz, Dual Output

Model 8015A

361



- Two independent ± 16 V outputs
- Additional TTL output

- Remote control and counted burst options
- Complex waveforms

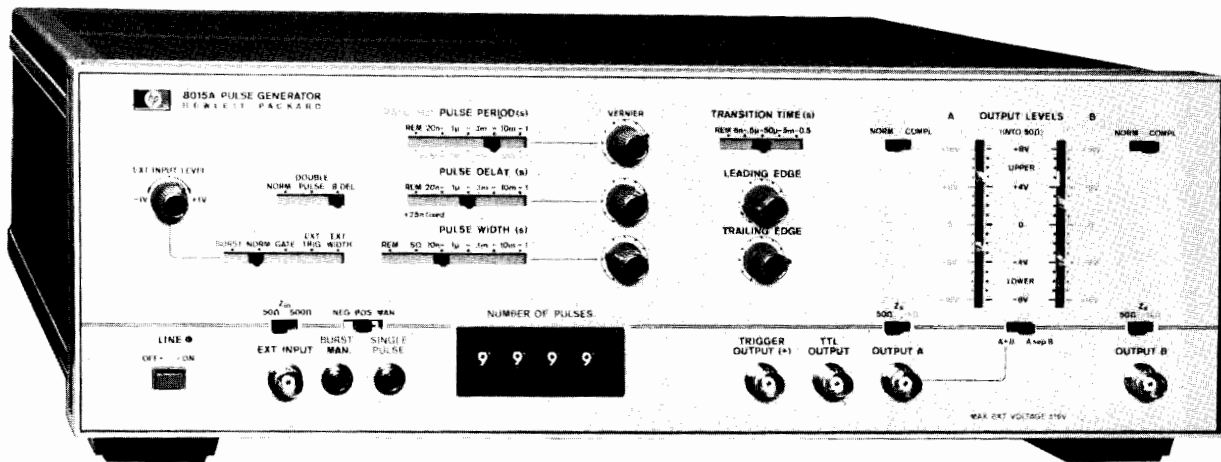

8015A Option 002

Offering B Delay mode in addition to variability of all pulse parameters, the 8015A is ideal for analyzing critical timing conditions, or generating 2-phase clocks.

A + B mode gives a 30 V output within a ± 16 V window. Combined with B Delay mode, three-level signals, special codes or simulated biomedical signals can be generated.

Option 002 Burst mode generates an exact number of pulses by means of an internal counter.

Direct access to either or both output amplifiers (Option 007) converts to MOS/CMOS levels. Alternatively, high-level tracking capability ensures that clock and data signals follow the supply, and thus safeguards CMOS devices.

For use in automatic test, Option 003 allows all pulse parameters to be controlled remotely.

Specifications

Timing

Repetition rate: 1 Hz to 50 MHz (square wave and double pulse to 25 MHz, A + B mode to 40 MHz, B delay 20 MHz).

Width: 10 ns to 1 s or square wave.

Delay: 20 ns to 1 s (both channels, interchannel or double pulse).

Jitter: 0.1% + 50 ps.

Output (50 Ω Output Impedance into 50 Ω termination. Voltages double in 50 Ω / 1 k Ω or 1 k Ω / 50 Ω operation).

Magnitude: 1 V to 8 V amplitude (2 V to 16 V in A + B mode).

High level: -7 V to +8 V. **Low level:** -8 V to +7 V.

Transition times: 6 ns to 0.5 s in four ranges, independent leading/trailing vernier adjustment.

Non-linearity: 5% for transitions > 30 ns.

Preshoot, overshoot and ringing: 5%.

A + B mode: sum of channel A and channel B outputs.

Complement: independently selectable.

Impedance: 50 Ω / 1 k Ω , independently selectable.

Trigger Input

Impedance: 50 Ω / 500 Ω selectable.

Level: adjustable +1 V to -1 V (50 Ω), +10 V to -10 V (500 Ω).

Slope: + or - selectable.

Auxiliary Outputs

TTL: 50 Ω output impedance, timing as channel A.

Trigger output: 1 V, 50 Ω into 50 Ω .

Option 002 Burst Mode

Burst length: 1-9999 pulses, selectable.

Pulse Repetition rate: 1 Hz to 40 MHz.

Burst trigger: trigger input.

Minimum Burst Separation: 200 ns.

Option 003 Remote Control

Timing ranges: TTL or contact closure.

Timing verniers: current, voltage or resistor programming.

Output levels: voltage programming.

Burst: BCD, TTL/contact closure.

Option 007 Amplifier and Tracking Modes

Dual Amplifier Mode

Gain: 0.8 to 6.4.

Frequency response (-3 dB): 0 to 80 MHz.

Upper Level Tracking Mode

Upper level: input voltage $\pm 5\%$.

Lower level: 0 V ± 250 mV.

Settling time: 400 μ s to $\pm 5\%$ of final value.

General

Operating temperature: 0°C to 55°C.

Power: 100/120/220/240 V rms; +5%, -10%; 48 to 440 Hz, 180 VA max.

Weight: net, 11 kg (24.26 lb); shipping, 14.7 kg (32.4 lb).

Size: 133 H x 426 W x 346 mm D (5.2" x 16.75" x 13.6").

Ordering Information

Ordering Information	Price
8015A Pulse Generator	\$3955
Opt 002: Pulse Burst	add \$650
Opt 003: Remote Control	add \$1560
Opt 007: Dual Amplifier and Level Tracking modes	add \$445
Opt 907: Front Handle Kit (Part No. 5061-0089)	add \$32
Opt 908: Rack Flange Kit (Part No. 5061-0077)	add \$25
Opt 909: Opt. 907, 908 combined (Part No. 5061-0083)	add \$55
Opt 910: Additional Operating and Service Manual	add \$38

PULSE & DATA GENERATORS

100 MHz Pulse Source

Model 8007B

- Variable transition times down to 2 ns.

- Extremely linear slopes

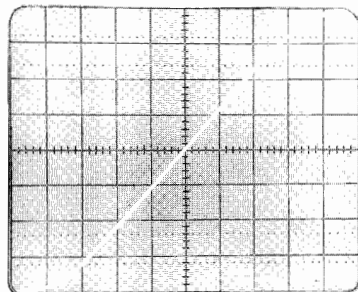
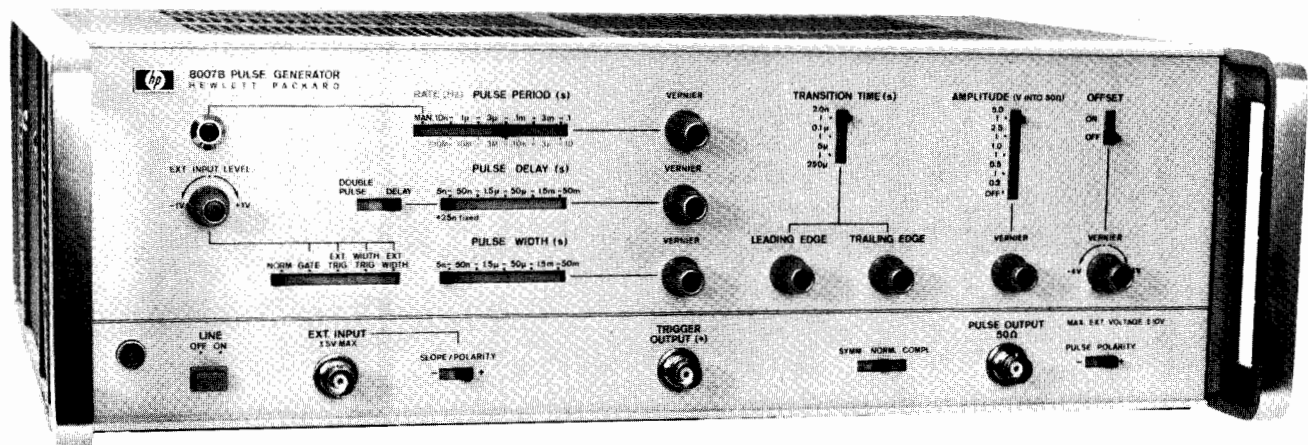

1 ns/cm
0.5 V/cm
1 GHz bandwidth

The 8007B is a high speed pulse generator that is well suited for STTL and ECL applications.

The output can be set to positive or negative polarity, complement or symmetrical to ground. A high dc-offset of up to ± 4 V is also included.

External triggering and synchronous gating are provided. The trigger level is adjustable for all externally controlled modes with the slope polarity selectable. This is very useful for avoiding malfunctions caused by noise and ringing on the external trigger signal.

In "External Width" mode the external input and pulse output have equal width. Transition times and amplitude of the output pulse can be set by the front panel controls. This mode is useful for shaping NRZ signals, as the width information is passed on to the output pulse unchanged.

The "Width Trigger" mode is suitable for RZ signal shaping. Width, transition times and amplitude are determined by the front panel controls.

Specifications

Pulse Characteristics (50 Ω Source and Load Impedance)

Transition times: <2 ns to 250 μ s, three ranges (common for both transition times). Independent verniers for adjusting leading and trailing edge within each range up to maximum ratios of 1:50 or 50:1.
Linearity: maximum deviation from a straight line between 10% and 90% points $\leq 5\%$ of pulse amplitude.

Preshoot, overshoot, ringing: < $\pm 5\%$ of pulse amplitude.

Pulse width: <5 ns to 50 ms in five ranges. Vernier provides continuous adjustment within ranges.

Width jitter: <0.1% on any width setting.

Maximum duty cycle: normal >50%; complement approx. 100%.

Amplitude: 5 V max (10 V across open circuit) to 0.2 V in four ranges; vernier adjustment within ranges. Pulse can be switched off.

Pulse output: + or - polarity selectable; normal, complement, or symmetrical to ground.

Source impedance: 50 $\Omega \pm 4\Omega$ shunted by typ. 10 pF.

DC-offset: ± 4 V across 50 Ω load. Independent of amplitude setting, can be switched off.

Pulse delay: <30 ns to 50 ms with respect to trigger output. Five ranges, with continuous adjustment within ranges.

Delay jitter: <0.1% on any delay setting.

Repetition Rate and Trigger

10 Hz to 100 MHz in 5 ranges. Continuous adjustment within ranges.

Period jitter: <0.1%.

Double pulse: available only up to pulse rate setting of 50 MHz, representing an output pulse rate of 100 MHz.

Trigger output: >+1 V across 50 Ω , 4ns ± 2 ns wide.

External Triggering (0 to 100 MHz)

Delay: approx. 15 ns between trig. input and trig. output.

Manual: front panel pushbutton for single pulse.

External Width and Width Trigger

External width: output pulse width determined by width of drive input.

Width trigger: external drive input switched to the width generator. Pulse width determined by front panel width setting.

Rate generator: provides trigger pulses independent of drive input.

Synchronous Gating

Gating signal turns generator "on." Last pulse is completed even if gate ends during pulse.

External Input

Impedance: 50 Ω , dc-coupled. Max input ± 5 V.

Level: adjustable from +1 V to -1 V, Polarity: + or -.

Sensitivity: sine waves 1 V p-p; pulses 1 V.

General

Operating temperature: 0°C to +55°C.

Power requirements: 115 or 230 V rms; +10%, -15%; 48 to 440 Hz, 100 VA (maximum).

Weight: net, 8 kg (17.6 lb). Shipping, 9 kg (19.8 lb).

Size: 128 H x 426 W x 345 mm D (5" x 16.8" x 13.6").

Ordering Information

8007B Pulse Generator

Price
\$3295

Opt 908: Rack Flange Kit (Part No. 5060-8740)

add \$22

Opt 910: Additional Operating and Service Manual

add \$28

- < 1 ns variable transition times
- Ultra-clean 50 ohm source
- Switch-selectable ECL levels
- Dual ± 5 V outputs



The 8082A is Hewlett-Packard's fastest pulse generator with all pulse parameters variable. With repetition rates to 250 MHz, transition times down to 1 ns and amplitudes to 5 V, the 8082A is ideally suited for state-of-the-art TTL and ECL logic designs. Using the 8082A, you can rapidly test logic circuits under all operating conditions by simply varying pulse parameters. Although a highly sophisticated instrument, the 8082A is still easy to operate because of its logical front panel layout and switch-selectable ECL output levels. Another feature that contributes to ease of operation is the square wave mode. You can, for example, carry out toggle rate tests in this mode up to 250 MHz without having to worry about pulse duty cycle.

Hybrid IC's, manufactured by Hewlett-Packard, are used extensively in the design of the 8082A. These ICs eliminate the need for fans, reduce power consumption and enable a low reactance 50 ohm source impedance to be used. This source impedance absorbs 98% of reflections from signals up to 4 V amplitude.

Specifications

Pulse Characteristics (50Ω Source and Load Impedance)

Transition times: < 1 ns - 0.5 ms (10% to 90%) in 6 ranges. < 750 ps (20% to 80%). Leading/trailing edges controlled together on fastest range, independently variable over 1:10 ratio on other ranges.

Overshoot and ringing: $\leq \pm 5\%$ of pulse amplitude may increase to $\pm 10\%$ with amplitude vernier CCW.

Preshoot: $\leq \pm 5\%$ of pulse amplitude.

Linearity: linearity aberration for both slopes $\leq 5\%$ for transition times > 5 ns.

Output: maximum amplitude is 5 V from 50Ω into 50Ω. Maximum output voltage is ± 5 V (amplitude + offset).

Offset: ± 2 V, into 50Ω.

DC-source impedance: 50Ω $\pm 5\%$.

Reflection coefficient: reflection is 2% typical for steps with 1 ns rise time applied to output connector on all amplitude ranges except 5 V range. On the 5 V range, the reflection may be 15%.

Output protection: cannot be damaged by open or short circuits or application of ext. $\leq \pm 6$ V or ± 200 mA independent of control settings.

Attenuator: two separate three step-attenuators reduce the outputs to 1 V. Vernier is common for both outputs and reduces the output to 0.4 V minimum. A further position provides ECL-compatible outputs (-0.9 V to -1.7 V typ. open circuit).

Timing

Repetition rate: 250 MHz to 1 kHz in 6 ranges.

Period jitter: < 0.1% of setting + 50 ps.

Delay: 2 ns - 0.5ms in 6 ranges plus typ. 17 ns fxd. with respect to trigger output. Duty cycle > 50%.

Delay jitter: < 0.1% of setting + 50ps.

Double pulse: up to 125 MHz max. (simulates 250 MHz).

Pulse width: < 2 ns - 0.5 ms in 6 ranges.

Width jitter: < 0.1% of setting + 50 ps.

Width duty cycle: > 50%.

Square wave: delay and double pulse are disabled, max. Rep. Rate 250 MHz. Duty cycle is 50% $\pm 10\%$ up to 100 MHz, 50% $\pm 15\%$ for > 100 MHz.

Trigger output: negative going Square Wave (50% duty cycle typ.) > 500 mV from 50Ω into 50Ω. Internal 50Ω can be switched off by slide-switch on PC-board. Amplitude up to 1 V into 50Ω up to 200 MHz.

Trigger output protection: cannot be damaged by short circuit or application of external ± 200 mA.

Externally Controlled Operation

External input

Input impedance: 50Ω $\pm 10\%$. DC coupled.

Maximum input: ± 6 V.

Trigger level: adjustable -1.5 V to +1.5 V.

Slope control: positive, negative or manual selectable. In the manual position all ext. functions can be controlled by push button. Button pushed in simulates an "on-signal."

Sensitivity: sine-wave > 200 mV p-p pulses > 200 mV.

Repetition rate: 0 to 250 MHz.

External-controlled modes:

External trigger: there is approximately 7 ns delay between the external input and the trigger output. Rep. rate is externally controlled (is triggered by external signal). Trigger output provides the pulse-shaped input signal. Square wave mode is disabled.

Synchronous gating: gating signal turns rep. rate generator on. Last pulse normal width even if gate ends during pulse.

External width: output pulse width determined by width of drive input. Rep. rate and delay are disabled. Trigger output provides shaped input signal.

General

Operating temperature: 0°C to 55°C.

Power: 100/120/220/240 Vrms; +5%, -10%; 48-440 Hz. 85 VA max.

Weight: net, 7.9 kg (17.44 lb). Shipping 8.9 kg (19.63 lb).

Size: 133 mm H x 426 W x 345 mm D (5.2" x 16.75" x 13.6").

Ordering Information

8082A Pulse Generator

Ordering Information	Price
8082A Pulse Generator	\$4725
Opt 907: Front Handle Kit (part number 5061-0089).	add \$32
Opt 908: Rack Flange Kit (part number 5061-0077).	add \$25
Opt 909: Opt 907, 908 Combined (part number 5061-0083).	add \$55
Opt 910: Additional Operating and Service Manual	add \$28

PULSE & DATA GENERATORS

Configurable Pulse Generators 8080 System

- 300 ps transitions
- Interchannel delay for rapid timing measurements
- Clock + ½-rate data capability for effortless setup and hold time measurements

8080 Configuration SO4

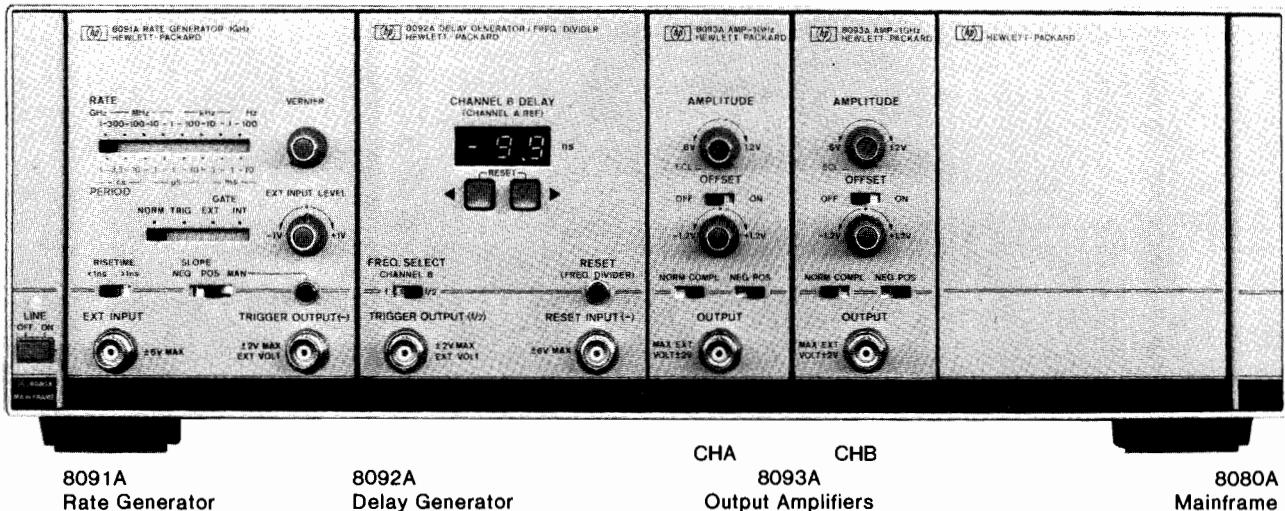

8080 System

Research and development in advanced technologies such as subnanosecond ICs, fiber optics and nucleonics, require fast rectangular pulses for evaluating products and experimental equipment. Additionally, where digital techniques are used, programmable data is necessary for functional verification.

For a cost-effective stimulus solution in high-technology environments, the ability to adapt to changing requirements is as important as meeting state-of-the-art needs. Consequently, the 8080 System has been designed with a configurable structure for flexibility as well as the technology for today's fast pulse applications.

Factory-configured generators are available as Special Options (see Ordering Information). Two examples are described on these pages.

1 GHz Pulse Generator 8080A SO4

The configuration illustrated above is a dual output 1 GHz generator with very fast, 300 ps, pulse edges. Internal/external trigger and gate capabilities are offered. With separate output amplifiers, the dual channels are independently adjustable in terms of amplitude, offset, polarity and logic inversion. ECL levels are rapidly selected by turning the amplitude vernier to a detent position. Additionally, channel B can be delayed or advanced with respect to channel A. The delay is set in 100 ps steps by convenient up/down pushbuttons and indicated on a clear 2-digit LED display.

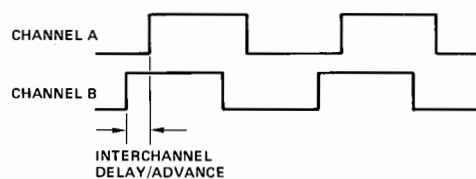

For rapid setup and hold measurements, the delay generator has an additional feature which allows a clock signal and a half-frequency data stream—representing alternate 0 s and 1 s—to be generated simultaneously.

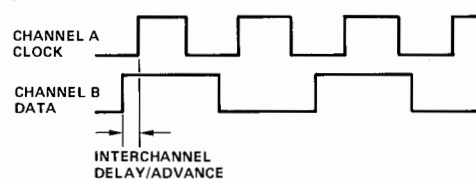

8080 Main Specifications for 1 GHz Pulse Generator SO4

Timing

Repetition rate: 100 Hz–1 GHz, jitter $\leq 0.1\% \pm 20$ ps. Ext trigger and gate; trigger level -1 V to $+1$ V variable, slope selectable. Selection of divider reduces Channel B frequency by factor 2.

Delay/advance: ± 9.9 ns in 100 ps steps.

Width: Square wave.

Output

Normal/complement, neg/pos selectable; 50 Ω source

Amplitude: (into 50 Ω): 0.6 V to 1.2 V variable, offset zero or variable in the range ± 1.2 V. Vernier detent gives ECL levels (-0.8 V, -1.6 V), capable of ± 0.9 V internal offset adjustment.

Transition times: (10% to 90%): ≤ 300 ps. Preshoot, overshoot, ringing $\leq 10\%$ ($\leq 15\%$ above 500 MHz).

8080 Specifications for 300 Mbit/s Data Generator DO1

Timing

Repetition rate: 10 Hz - 300 MHz, jitter $\leq 0.1\% \pm 50$ ps. Ext trigger and gate; trigger level -1 V to $+1$ V variable, slope selectable.

Data: Serial data stream of 16, 32, or 64 bits, single/continuous cycle or gateable. Clock and First Bit and Last Bit Synch outputs. Data output RZ/NRZ selectable.

Output

Simultaneous normal and complement outputs, neg/pos selectable; 50 Ω source.

Amplitude: (into 50 Ω): 0.2 V to 2 V variable, offset zero or variable in the range ± 1 V. Switch position gives ECL levels (-0.8 V, -1.6 V).

Transition times: (10% to 90%): 800 ps. Preshoot, overshoot, ringing $\leq 10\%$.

8080 General

Operating temperature: 0°C to 55°C.

Power: 115/230 V rms; $+10\%$, -22% ; 48 to 66 Hz, 200 VA max.

Weight: (typical, 8080A Mainframe plus full complement of modules) 9.4 kg (16.6 lbs) net; 19.7 kg (43.3 lbs) shipping.

Size: (8080A Mainframe): 133 H \times 426 W \times 422 mm D (5.24" \times 16.77" \times 16.61")

PULSE & DATA GENERATORS

Configurable Pulse Generators
8080 System

365



- 800 ps transitions
- Dual complement outputs, $\pm 2V/ECL$
- RZ/NRZ data format
- 16/32/64-bit word lengths

8080 Configuration DO1

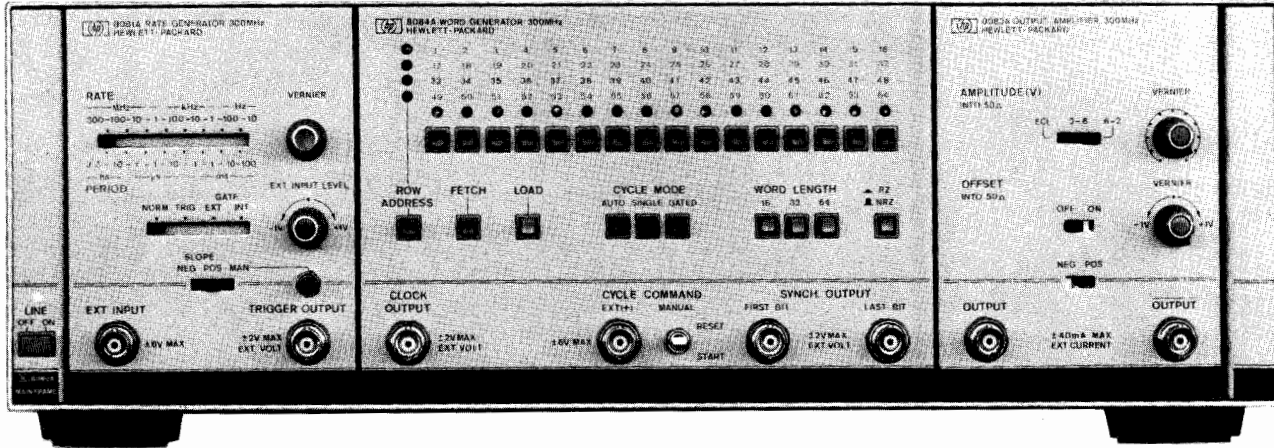

8080A Mainframe 8081A Rate Generator 8084A Word Generator 8083A Output Amplifier

The 8080 system introduced on the previous page can also be configured as a data generator. The following example provides data streams suitable for fast serial digital devices and data links.

300 Mbit/s Data Generator 8080A DO1

By means of the Word Generator module, serial data can be freely programmed in 16, 32 or 64-bit word lengths. Depending on operating mode, a word can be single shot triggered or continuously cycled.

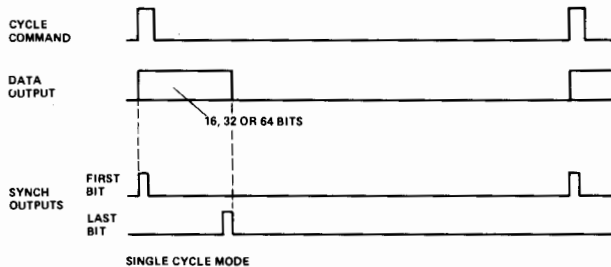
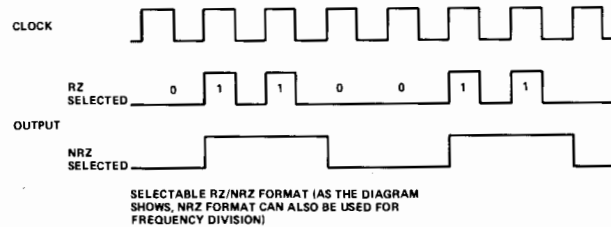

Furthermore, gate mode allows continuous cycling for the duration of the gate.

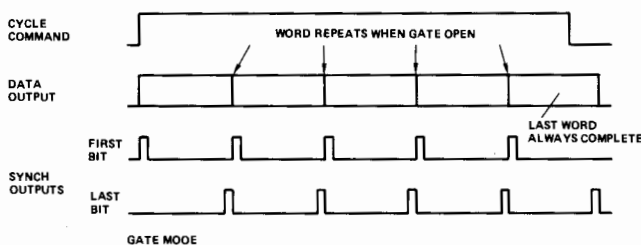

Data content is programmed by means of 16 pushbuttons with LED indicators. For word lengths greater than 16 bits, the pushbuttons are successively reassigned to the word segment being programmed. Data format is selectable, NRZ mode giving additionally a means of adjusting pulse width and frequency division by data programming.

With the 8083A Output Amplifier, normal and complement outputs are available simultaneously. Amplitude, offset and polarity adjustments apply to both outputs, and a switch provides easy selection of ECL levels. If faster transitions or independent output level controls are needed, two 8093A Output Amplifiers could be used instead.

Ordering Information

Individual Units

Order individual units if you wish to configure your own generator or extend an existing one. Refer to the next page for factory-configured generators.

8080A Mainframe	\$2035
Opt 907: Front handle kit (part number 5061-0089).	\$32
Opt 908: Rack flange kit (part number 5061-0077).	\$25
Opt 909: Opt 907, 908 combined (part number 5061-0083).	\$55
Opt 910: Additional manual.	\$28
15400A: Blank Panel, quarter mainframe width.	\$60
15401A: Blank Panel, eighth mainframe width.	\$60
15402A: Feedthru panel (6 BNCs), eighth mainframe width.	\$220
8081A 300 MHz Rep Rate Generator module.	\$1375
8083A 300 MHz Output Amplifier module.	\$1375
8084A 300 MHz Word Generator module.	\$3460
8091A 1 GHz Rep Rate Generator module.	\$4085
8092A 1 GHz Delay Generator/Frequency Divider module.	\$3225
8093A 1 GHz Output Amplifier module.	\$2095

Factory-configured generators: see next page.

PULSE & DATA GENERATORS

Configurable Pulse and Data Generators
8080 System (Cont.)

8080A Ordering Information: continued

Factory-configured generators

Pulse Generators

Model	Frequency	TR	Price
8080A S01	300 MHz	≤ 800 ps	\$4905
8080A S02	300 MHz	≤ 300 ps	\$5685
8080A S03	1 GHz	≤ 300 ps	\$8395
8080A S04	Dual-channel 1 GHz	≤ 300 ps	\$13695

Data Generators

8080A D01	300 MHz, $T_R \leq 800$ ps	\$8245
8080A D02	300 MHz, $T_R \leq 300$ ps	\$9025

For inclusion of handles, etc, please add 8080A Mainframe option number, e.g.:
8080A S02 + 908 + 910

8080A S01

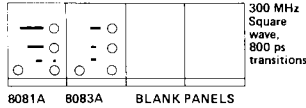

8080A S02

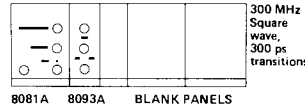

8080A D01

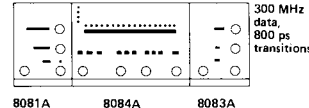

8080A D02

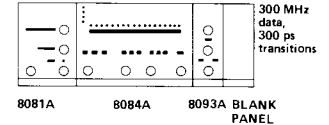

8080A S03

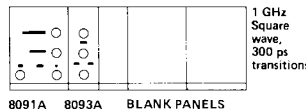

8080A S04

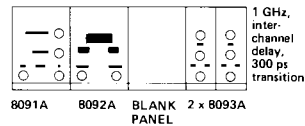

Other factory-configured generators

Please apply to your local HP office for details.

Pulse Generator Definitions (continued from General Information, p. 349)

Time Reference Point: Median (50% amplitude point on pulse edge).
Pulse Period: The time interval between the leading edge medians of consecutive trigger output pulses.
Trigger Delay: Interval between trigger point of input signal and the trigger output pulse's leading edge median. Applies in trigger, external width, gate and burst modes.

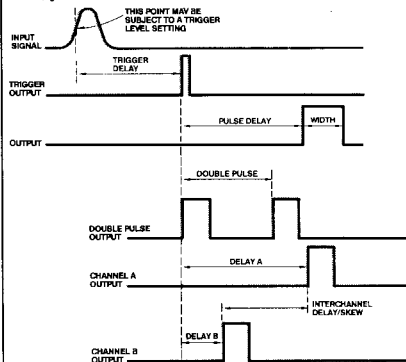

Pulse Delay: Interval between leading edge medians of trigger output pulse and output pulse.

Double Pulse: Interval between leading edge medians of the double pulse.

Interchannel Delay/Skew: Interval between corresponding leading edge medians.

Pulse Width: Interval between leading- and trailing-edge medians.

Additional Information for Pulse Generators with Variable Transition Times

Pulse Width: The specified and displayed value is that obtained with fastest edges; essentially equal to the interval from the start of the leading edge to the start of the trailing edge.

By designing so that the pulse edges turn about their start points, the interval from leading edge start to trailing edge start stays unchanged* when transition times are varied. This is more convenient for programming and the width display is easy to interpret.

*In practice, start points may shift with change in transition time.

Delay: The specified and displayed value is that obtained with the fastest leading edge. For a slower edge, the actual delay exceeds the displayed delay by the combined shift of start-point and median.

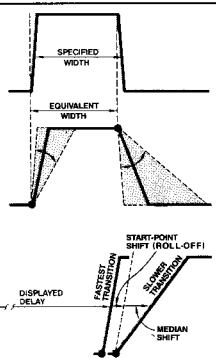

Transition Time: Interval between the 10% and 90% amplitude points on the leading/trailing edge.

Linearity: Peak deviation of an edge from a straight line through the 10% and 90% amplitude points, expressed as percentage of pulse amplitude.

Jitter: Short-term instability of one event with respect to another. Unless stated otherwise, value is p-p, expressed as a percentage of the main parameter.

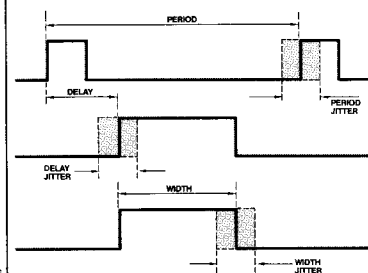

Stability: Long-term average instability, expressed as percentage of main parameter over a specific time duration, e.g. hour, year. Excludes jitter.

Pulse Level: High level and low level. Any limitation is expressed by an amplitude specification.

Pulse Amplitude (alternative to level definition): Pulse amplitude and offset* are specified. Any limitation is expressed by a window (max high level, min low level).

*Pulse generators use baseline offset. Function generator outputs are symmetrical and consequently use median offset.

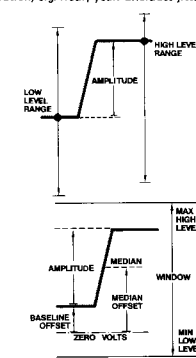

Preshoot, Overshoot, Ringing: Preshoot and overshoot are peak distortions preceding/following an edge. Ringing is the positive peak and negative peak distortion excluding overshoot, on pulse top or base. A combined preshoot overshoot, ringing specification of e.g. $\pm 5\%$ implies:

- Overshoot/undershoot $< 5\%$,
- Largest pulse-top oscillation $< \pm 5\%$ of pulse amplitude.

Settling Time: Time taken for pulse levels to settle within level specification, measured from 90% point on leading edge.

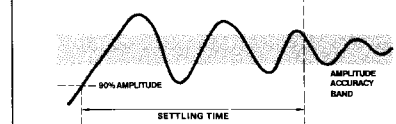

Duty Cycle: Percentage ratio of pulse width to period. In pulse/function generators, this term is also used to define sine and triangle symmetry.

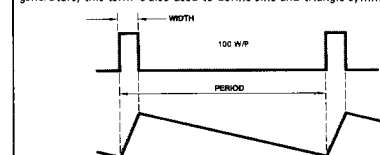

Output Impedance/Resistance: Effective pulse source impedance/dc resistance.

Reflection Coefficient: Reflection at pulse generator output expressed in percent of incident pulse amplitude. (Test pulse edges correspond to generator's fastest transitions).

Repeatability: When an instrument operates under the same environmental conditions, and with the same settings, the value of a parameter will lie within a band inside the accuracy window. Repeatability defines the width of this band.

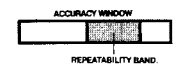

HP-IB Programming Times

Listen Time: The time an instrument occupies the bus to receive and verify a message. The NRFD signal is active during this period.

Settling Time: The time taken by the instrument to execute an HP-IB message, and for the output to settle within the accuracy specification. NRFD inactive.

Execution Time: The sum of Listen Time and Settling Time.

Talk Time: The time an instrument occupies the bus to output a specified string. Output data is typically instrument error status, or current or stored parameters.

PULSE & DATA GENERATORS

50 MHz Serial Data/PRBS Generator

Model 8018A



- 2048 bit, dual channel memory
- Variable word and pattern length

- TTL, ECL, CMOS compatible
- Programmable, prbs and mixed data

Option 001

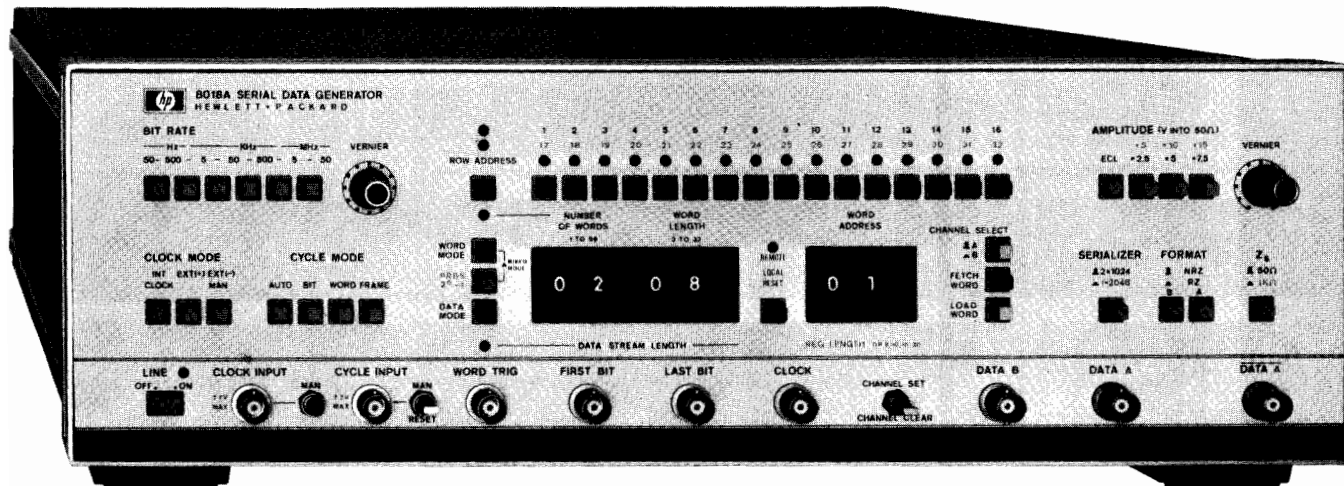

With 2048 programmable bits, and a choice of pseudo-random binary sequences (prbs) ranging to over 1M bits, the 8018A is a powerful stimulator for serial digital systems and devices requiring high bit rate and fast pulses. Even preamble-data-post-amble data link patterns are feasible by combining prbs and programmed data. Useful synch outputs simplify testing by locking scope or analyzer to unique points in the data stream. Variable 15 V pulses and selectable ECL levels allow direct connection to all logic families. Data can be programmed by HP-IB (Option 001) and Card Reader (Option 002).

Specifications

Data Capacity and Modes

Programmable memory: 2 channels, each 1k bit, serializable. Thumbwheel switches define data stream length or frame length (N words of M bits), and set up synch signals accordingly.

Prbs: pseudo-random binary sequences of 511, 1023, 32767 and 1048575 bits. Synch pulse at beginning of sequence.

Mixed: prbs is inserted after every odd-numbered programmable word.

Data Outputs

Channel A: Simultaneous normal and complement outputs. ECL levels or variable +15 V amplitude. Selectable 50 Ω /1k Ω output impedance, RZ/NRZ format.

Data length: up to 1024 bit or (serialized with B data) 1025 to 2048 bit.

Transitions (50 Ω into 50 Ω): ≤ 6 ns (ECL ≤ 5 ns)

Preshoot, overshoot, ringing: $\leq 10\%$ (ECL $\leq 15\%$)

Channel B: normal output, 2.4 V (50 Ω into 50 Ω), up to 1024 bits, RZ/NRZ selectable.

Bit Rate

Internal: 50 Hz to 50 MHz (40 MHz in Mixed mode), jitter 0.2%

External: dc to 50 MHz (40 MHz in Mixed mode) or manual.

Data Cycling

Auto: Sequence recycles continuously.

Bit: bits are triggered/gated by external pulses/level.

Word: words are triggered/gated by external pulses/level.

Frame: sequence is triggered/gated by external pulses/level.

Manual: switch triggers single bits/words/frame.

General

Power: 100/120/220/240 V rms; +5%, -10%; 48 to 440 Hz. 230 V A max.

Temperature Range: 0°C to 50°C.

Weight: net 12 kg (26.5 lbs); shipping 16 kg (35.3 lbs).

Size: 133 H x 426 W x 422 mm D (5.2" x 16.8" x 16.6").

Ordering Information

8018A Serial Data Generator

Price

Opt 001: HP-IB for data loading* \$650

Opt 002: 15263A Card Reader. Option 001 required. \$990

Opt 907: Front Handle Kit (Part No. 5061-0089) \$32

Opt 908: Rack Flange Kit (Part No. 5061-0077) \$25

Opt 909: Opt. 907, 908 combined \$55

(Part No. 5061-0083)

Opt 910: Extra Operating and Service Manual add \$38

* HP-IB cables: refer to page 30.

Accessory for 8016A, 8018A, 8170A

Card Reader

Model 15263A

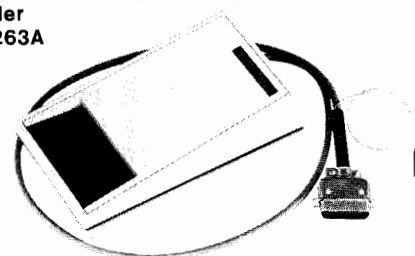

To save manual re-entry, or tying up a system controller for a bench job, marked cards and HP 15263A Card Reader provide permanent storage and easy re-loading. The 8016A Option 001, 8018A Option 001 and 8170A all provide the necessary power jack and HP-IB capability for operating with the 15263A.

Specifications

General

Power: +5V, 550mW.

Weight: 0.6 kg (1.3 lb); shipping 1.6 kg (3.5 lb)

Size: 57 H x 115 W x 195 mm D (2.2" x 4.5" x 7.6")

Accessories Supplied: 50 cards (Part No. 9320-0595)

Ordering Information:

15263A Card Reader

Price

\$990

Note: If ordering Card Reader same time as 8016A or 8018A order 8016A or 8018A Option 001 + 002



PULSE & DATA GENERATORS

Logic Pattern Generator for Bus Stimulation

Model 8170A

- 8 k memory (32 k option)
- 8 bit / 16 bit parallel output
- 2 wire / 3 wire handshake capability
- Internal and external addressing

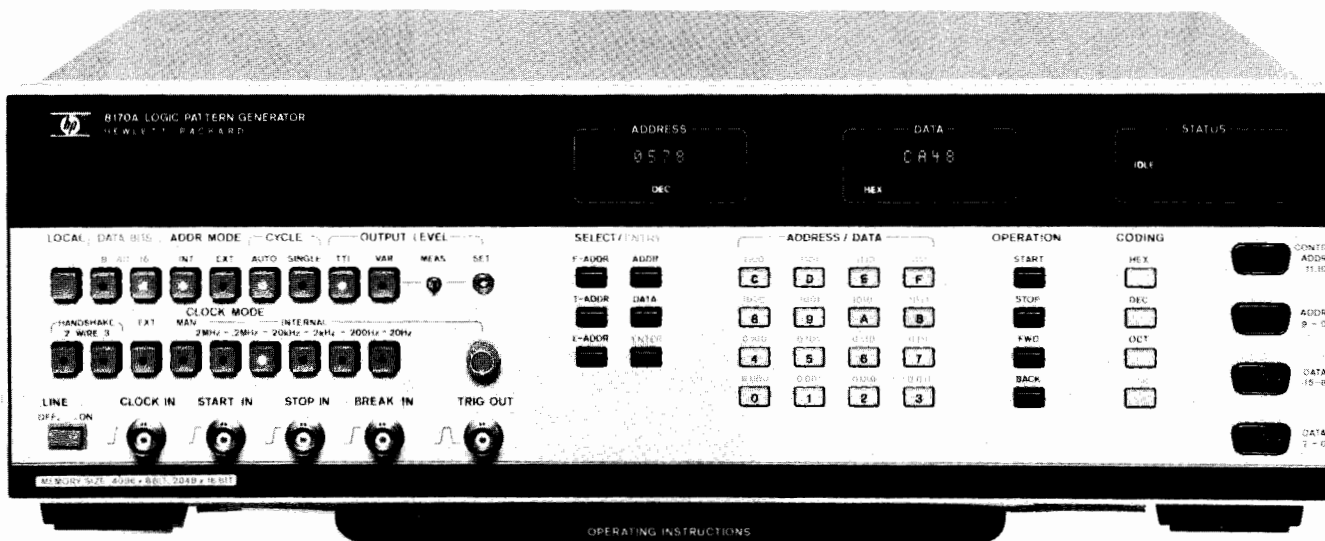

Introduction

The 8170A Logic Pattern Generator is a real-time test stimulus for functional checkout of today's multi-channel logic devices and subassemblies. With data traffic in modern digital systems routed over a shared bus, the 8170A's direct bus driving capability makes design verification at every stage in system development and production a quick, straightforward task.

Data generation by the 8170A is in parallel 8-bit or 16-bit format, to a memory depth of 1024 or 512 words respectively (optionally extendable to four times that capacity). This, combined with a variable clock rate up to 2 MHz permits thorough functional testing at full system operating speed. In addition, output levels of the 8170A ensure a direct match to today's most widely employed logic families—TTL and CMOS, while specially designed mini-probes minimize hook-up problems to the device under test.

Selectable Codes

Designed around the 6800 microprocessor, the 8170A's control scheme permits data, address and operating modes to be entered directly via the instrument keyboard. A sophisticated feature of keyboard programming is the multi-code format available for address and data. Codes include octal, decimal and hexadecimal (see specifications), the microprocessor automatically performing code conversion to the binary base. When fast program check or recall is required, alphanumeric LED's display individual data-address lines in the selected code.

Internal Address Mode

The 8170A's internal address mode is specifically intended for driving digital busses. Typical bus traffic is simulated by generating data in an ascending address sequence, the first and last address being pre-

set by the user. The 8170A can be thus programmed for detailed investigation of selected bus functions.

Whether the tested bus operates synchronously or asynchronously, the 8170A generates the necessary test signal. With NORM selected, the 8170A outputs data in response to a clock signal (internal, external or manual). Where a bus operates in an asynchronous 2-wire or 3-wire handshake system, the 8170A generates data and data valid signals in accordance with the selected protocol.

External Address Mode

In external address mode, 8170A operation is analogous to the RE-PROM. Data is output according to the state of externally applied address and enable lines. The main advantage using the 8170A is the ease with which data can be loaded or modified via the keyboard—as opposed to generally complicated processes demanded by RE-PROM's. Where time is a valuable commodity such as in software test and development, the 8170A presents significant savings in this mode.

HP-IB

With full programmability via the HP-IB interface bus, the 8170A's application base extends to automated test systems. Employing microprocessor control over all interface functions, a syntax has been developed to make remote programming of the 8170A as simple as manual operation.

RS 232C-CCITT V.24

In many applications, a multi-line readout is necessary for quick program set-ups and checks. For this reason, the 8170A is designed to be compatible with the serial RS 232C/CCITT V.24 interface standard. By linking the 8170A to a low cost data terminal over this interface, the multi-line listing of the 8170A memory enables fast data modification.



Specifications

Memory Size

Capacity: 8 kbit.

Data bus format: 8 bit or 16 bit wide.

Operating States

Idle: permits entry of address, data and operating parameters.

Active: continuous data output.

Break: pause in data output. FWD/BACK enables further data output.

Address Modes

Internal: data generation in ascending address sequence from F-ADDR to L-ADDR (F-ADDR, L-ADDR = user-defined first and last addresses).

External: data output follows external address and enable signals. DAV generated at each new address. Data and DAV high impedance when instrument not enabled. Clock and cycle modes disabled.

Maximum address rate: 2 MHz.

Address to output delay: 400 ns typ., 550 ns max.

Enable to output delay: 100 ns typ., 130 ns max. DAV at min.delay.

Clocking

Internal: 20 Hz to 2 MHz in 5 decade ranges.

Rate jitter: <0.2%

External: dc to 2 MHz. For inp. specs, see "Auxiliary inputs".

Manual: operated by FWD and BACK key.

Handshake: 2-wire/3-wire handshake capability selectable.

Cycle Modes

Auto cycle: data is continuously generated between F- and L-ADDR.

Single cycle: data is generated once between F- and L-ADDR. After cycle completion, 8170A returns to IDLE state.

Output Signals

Data: pods provide 16 output lines D0-D7 (model 15455A), low byte, and D8-D15 (model 15456A), high byte. Pos./neg. true select on rear panel.

Control: data valid (DAV) generated with each word. Pos./neg. true selectable on rear panel.

DAV delay (adjustable on rear panel)

Non-handshake: 100 ns to 700 ns.

2- or 3-wire handshake: 300 ns to 800 ns.

Status: idle, active and break states indicated on lines ACS and BRS.

Pod Output Levels

TTL setting

Fan out: 5 standard TTL max.

Levels: high +4.5 V to +5 V; low -0.5 V to +0.4 V; idle 6 mA to ground.

Transition times (+0.4 V to +2.4 V): 25 ns typ. 50 ns max.

Variable setting

Maximum load: 50 pF (high impedance)

Levels: high +3 V to +15 V adj., low -0.5 V to +0.4 V.

Transition times (20% to 80%): 35 ns typ. 60 ns max.

Auxiliary Outputs

Trigger: generated at trigger address (T-ADDR).

Format: NRZ.

Levels: standard TTL.

Fan out: 5 standard TTL.

Probe: +5 V dc.

Address driver outputs (Opt. 002): provides 10 address output lines A0 to A9, positive true.

Fan out: 10 standard TTL.

Levels: high +2.4 V; low +0.5 V; idle 1.5 mA to +5 V.

Transition times (+0.5 V to +2.4 V): 50 ns.

Pod Input Signals

Input RC: > 10 k Ω /≤25 pF.

Levels: high ≥ +2.0 V; low ≤ +0.8 V.

Max. external voltage: ±18 V.

Address input pod (Model 15453A): 10 addressable input lines A0-A9 for operation in external address mode.

Control input pod (Model 15454A): following inp. lines available:

Ready for data (RFD), data accepted (DAC): for handshake mode. In 2-wire handshake RFD level selectable pos./neg. true. In 3-wire handshake, fixed levels for RFD, DAC (see IEE Std. 488-1975)

Enable E1, E2 (E3, E4 at rear panel): for operation in ext. address mode. Selectable levels pos./neg./don't care.

Address A10, A11: for extended memory, option 001.

Auxiliary Inputs

Clock in: for external clock signal input.

Start in: external signal starts data generation. Prompts 8170A transition from idle/break to active state.

Stop in: external signal stops data generation. Prompts 8170A transition from active/break state to idle state.

Break in: external signal halts 8170A at current address, outputs remain active. Prompts 8170A transition from active to break state.

Input conditions (all positive edge triggered)

Input RC: > 10 k Ω /≤25 pF.

Levels: high ≥ +2.0 V, low ≤ +0.8 V.

Min. width (at +1.3 V): Clock 40 ns; Start/Stop/Break 20 ns.

Max. external voltage: ±18 V.

HP-IB

Keyboard mode: remote programming of all front panel keys and functions. Coded loading and readout of data.

Data mode: fast binary loading and readout of data only.

RS 232C/CCITT V.24.

Remote editing and listing of memory content, and display of current data bus format and address/data coding.

Baud rate: 110, 150, 300, 600, 1200, 2400, 4800, 9600 selectable.

General

Power: 100/120/220/240 V rms; +5% - 10%; 48 - 66 Hz, 110 VA max.

Operating Temperature: 0°C to 55°C.

Weight: net 11 kg (24.3 lbs), shipping 15 kg (33.2 lbs).

Dimensions: 133 H x 426 W x 422 mm D (5.2" x 16.8" x 16.6").

Accessories Supplied

2 data output pods (15455A/6A), 1 address input pod (15453A), 1 control pod (15454A), a 2 m power cord and an operating/service manual. Each pod includes Snap-on Assembly 15458A for clip connection to DUT.

Ordering Information

	Price
8170A Logic Pattern Generator*	\$5950
Opt 001: 32 kbit Memory	add \$715
Opt 002: Address Driver Pod (Model 15452A).	add \$440
Opt 907: Front Handle Kit (part number 5061-0089).	add \$32
Opt 908: Rack Mount Kit (part number 5061-0077).	add \$25
Opt 909: Opt 907, 908 Combined (part number 5061-0083).	add \$55
Opt 910: Extra Operating and Service Manual.	add \$70
15457A Pod Connector (Pods can be easily plugged into DUT when this accessory is wired in).	add \$65
15263A Card Reader: rapid memory loading	\$990
*HP-IB cables not furnished, see page 30.	

PULSE & DATA GENERATORS

9-Bit Parallel, 32-Bit Serial, 50 MHz Word Generator

Model 8016A

- 2 complementary outputs per channel, RZ/NRZ formats
- Variable RZ width, 4 delay channels
- Channel serializer
- TTL/ECL output levels selectable

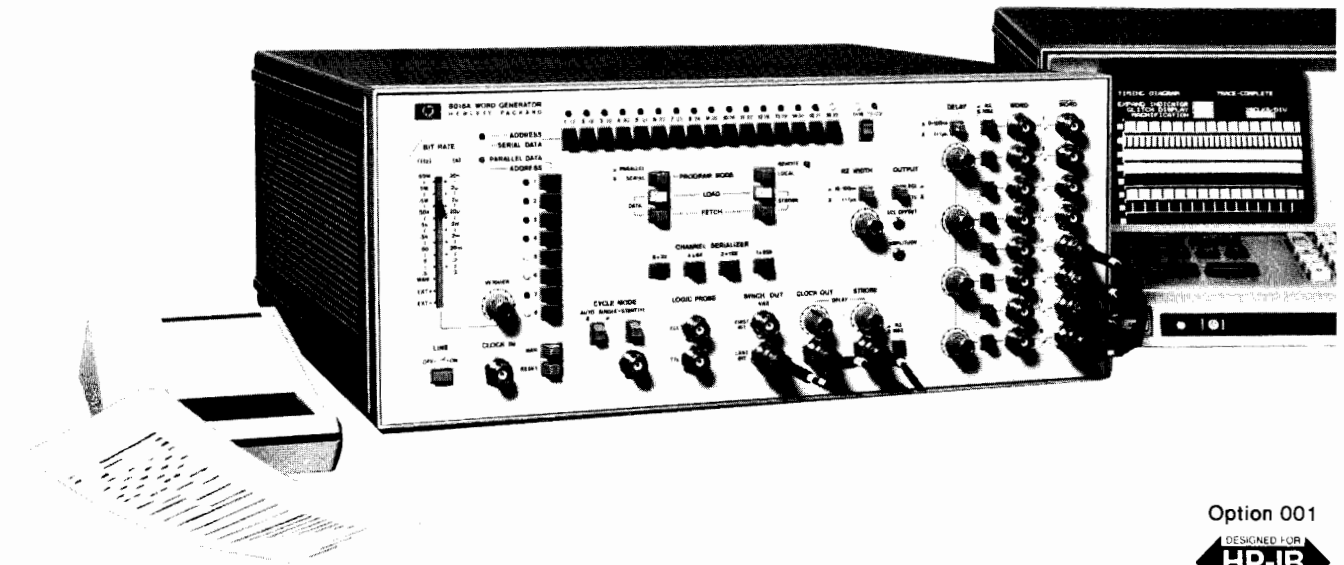

8016A Option 001 + 002

Option 001



The 8016A is a 9-channel data generator capable of serialization up to 256 bits. For the digital designer the 8016A is a natural companion to multichannel data display devices such as logic analyzers. As a bench or systems component, the 8016A provides programmable digital patterns plus adjustable timing parameters necessary for testing ICs and circuit boards.

Functional Test

Bit pattern programmability combined with fast cycle time (50 MHz clock) make the 8016A especially effective in simulating worst case conditions, e.g. high speed IC testing. The 8016A saves time in component evaluation environments because test setups can be rapidly built and reconfigured to meet the demands of testing small quantities of a wide variety of IC types.

Parametric Test

Complete testing of digital circuits and systems requires not only digital patterns for functional test but control of the analog parameters of the pulses as well. Adjustable pulse widths, levels, and inter-channel delays contribute to measurements such as setup and hold times, clock pulse width sensitivities, and system sensitivity to propagation delay variations. To meet these testing requirements, the 8016A includes 6 independent delay circuits. Output levels of the 8016A's 50 Ω output amplifiers are selectable for ECL or TTL test specifications and can be adjusted. In addition, a choice of RZ or NRZ formats with variable RZ pulse width is provided.

Specifications

Data Capacity: 8 data channels plus 1 strobe channel, each 32 bits. 8 data channels can be serialized as four 64-bit channels, two 128-bit channels or a single 256-bit channel.

Data Loading: address channel, enter 32 serial bits in that channel. Alternatively, address parallel word, enter (max 8) bits in that word. Addressing/entry by pushbuttons/LEDs or via HP-IB (option 001).

Data Outputs: (50 Ω source into 50 Ω load).

Format: independent RZ/NRZ selection in each channel.

RZ Width: single continuous adjustment in ranges 10-100 ns, 0.1-1 μ s.

Width jitter: $\leq 0.2\% + 50$ ps

Complement: Simultaneous normal and complement outputs for each channel.

Delay: channels 2, 4, 6, 8 can be delayed independently within the ranges 0-100 ns, 0.1-1 μ s with respect to odd channels.

Jitter: $\leq 0.1\% + 5$ ps

Skew (undelayed): ± 1 ns

Levels: ECL/TTL selectable

Transition Times: ≤ 3.0 ns (ECL ≤ 2.5 ns)

Bit Rate

Internal: 0.5 Hz to 50 MHz.

External: dc to 50 MHz, or manual.

Data Cycling

Auto: Sequence recycles continuously.

Single Cycle: Sequence is triggered/gated by external pulse/level.

General

Operating temperature: 0 $^{\circ}$ C to +50 $^{\circ}$ C.

Power: 100/120/220/240 Vrms; +5%, -10%; 48 Hz to 66 Hz, 200 VA (maximum)

Weight: net, 14.5 kg (32 lb). Shipping 16 kg (35.3 lb).

Size: 177 H \times 426 W \times 422 mm D (7" \times 16.8" \times 16.6").

Ordering Information

8016A Word Generator

Opt 001: HP-IB for data loading*

Opt 002: 15263A Card Reader. Option 001 required

Opt 907: Front Handle Kit (Part No. 5061-0090)

Opt 908: Rack Flange (Part No. 5061-0078)

Opt 909 Opt 907, 908 combined (Part No. 5061-0084)

Opt 910: Additional Operating and Service Manual

Price

\$8570

add \$770

add \$990

add \$40

add \$30

add \$65

add \$48

*HP-IB cables: Refer to page 30.

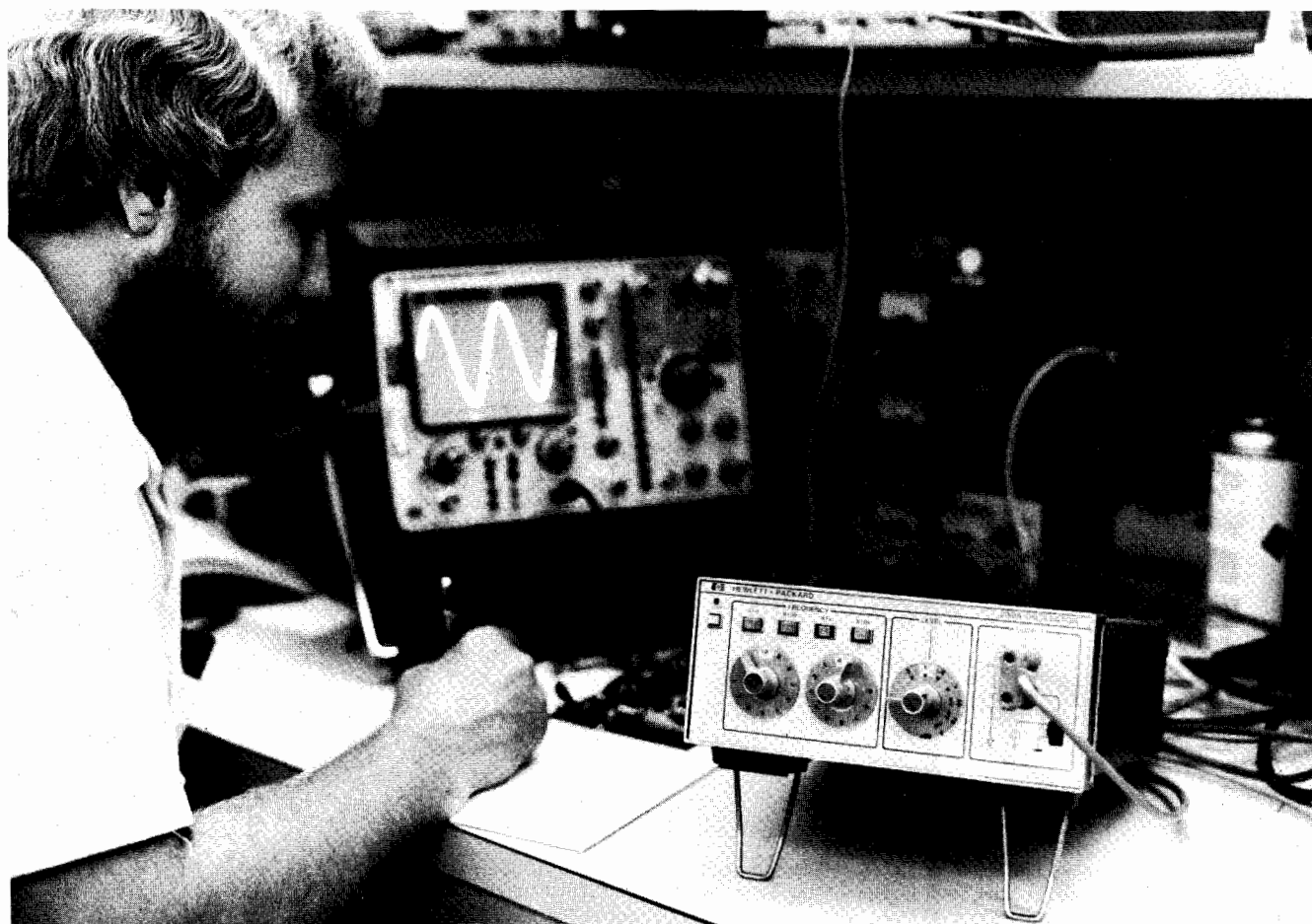

Signal sources are described by various names: oscillators, audio signal generators, function generators, etc. The names are typically associated with the application area. Signal generator describes an oscillator which has modulation capability. The term oscillator refers exclusively to a sinusoidal source while function generator always provides additional wave shapes, most often square waves, triangle waves, and increasingly, pulses.

In this section, we are considering oscillators covering the audio through video frequency range.

Basic Considerations

In choosing a particular oscillator, frequency range, output level and distortion (THD) are the key considerations. Typically, oscillators used for testing of audio equipment, filters, amplifiers, etc., require total harmonic distortion (THD) to be at least 65 dB and often as high as 95 dB. Oscillators used in video testing must provide signals to at least 6 MHz and often to 10 MHz. For many general purpose applications, high level signals are needed, an example being 10 volts in 600 ohms. Hewlett-Packard offers oscillators that meet all of these requirements. Table 1 is a summary chart comparing the main features of all the products.

Distortion

Distortion in total harmonic terms is a measure of the oscillator's signal purity. It is presented as a ratio of the total harmonic

content to the fundamental and expressed either as dB's below the fundamental or as a percentage of it. A typical value for audio work might be a THD of -60 dB ($\approx 0.1\%$). -95 dB is becoming more necessary especially in the audio entertainment and Hi-Fi areas. Hewlett-Packard offers this high level of signal purity in the 239A Oscillator.

Frequency Stability

Frequency stability of an oscillator determines the ability of the instrument to maintain a selected frequency over a period of time. Component aging, power-supply variations and temperature changes all affect stability. Carefully chosen components, such

as precision resistors and variable capacitors in the frequency-determining networks, contribute to long-term stability. Technology, particularly large scale integration, minimizes the adverse effects of temperature and in such situations all but eliminates the effects of discrete component aging.

Amplitude Stability

Amplitude stability with time and over a desired frequency range is an important characteristic in most applications. Hewlett-Packard uses negative feedback techniques to minimize variations in amplitude with time and pays great attention to circuit elements that influence the frequency response of the oscillator.

Oscillator Summary

INSTRU. NO.	FREQUENCY RANGE							POWER OUTPUT	THD	PAGE
	1 Hz	10	100	1 kHz	10 kHz	100 kHz	1 MHz			
200CD	—————							160 mW	0.2%	372
201C		—————						3 W	0.5%	372
204C	—————							10 mW	0.1%	374
204D	—————							10 mW	0.1%	374
209A	—————							40 mW	0.1%	374
239A		—————						17 mW	0.0018%	373
651B	—————							200 mW	1%	375
652A	—————							200 mW	1%	375
654A	—————							200 mW	1%	375

OSCILLATORS

5 Hz to 600 kHz Audio Oscillators

Models 200CD & 201C



200CD



201C

Description

These Hewlett-Packard oscillators have high stability and accurate, easily resettable tuning circuits. Low-impedance operating levels, together with superior insulation, guarantee peak performance throughout years of trouble-free service. The instruments have a wide frequency range, long dial lengths and feature an improved vernier frequency control.

Accessories Available

11000A Cable Assembly	\$20
11001A Cable Assembly	\$20
11004A Line Matching Transformer	\$110
11005A Line Matching Transformer	\$220

Price

Specifications

	200CD	201C
Frequency Range	5 Hz to 600 kHz	20 Hz to 20 kHz
Number of Ranges	5 overlapping	3 overlapping
Dial Accuracy	± 2%	± 1%
Frequency Response	± 1 dB (1 kHz ref)	± 1 dB (1 kHz ref)
Output (into 600Ω load)	>160 mW (10 V)	3 W (42.5 V rms)
Output Impedance	600Ω ± 10%	600Ω ± 10%, 20, 30 and 40 dB settings <600Ω, 0 dB and 10 dB settings
Output Balance	Balance and floating better than 0.1% at lower frequencies and approx. 1% at higher frequencies	One terminal at ground potential
Distortion	0.2%, 20 Hz to 200 kHz 0.5%, 5 Hz to 20 Hz and 200 kHz to 600 kHz	<0.5%, 50 Hz to 20 kHz at 1 W <1%, 20 Hz to 20 kHz at 3 W
Hum and Noise	<0.1% of rated output	<0.1% of rated output (amplitude control at max)
Attenuator	Bridged "T"	0 to 40 dB in 10 dB steps, coarse and fine controls
Input Power	115 or 230 V, 48 to 440 Hz, 90 VA	115 or 230 V, 48 to 440 Hz, 75 VA
Weight (kg (lb))	Net: 9.9 kg (22 lb) Shipping: 10.8 kg (24 lb)	Net: 7.2 kg (16 lb) Shipping: 8.6 (19 lb)
H x W x D Dimensions	292 mm x 187 mm x 365 mm (11.5" x 7.4" x 14.4")	292 mm x 191 mm x 318 mm (11.5" x 7.5" x 12.5")
Price	200CD: \$950	201C: \$950

- < -95 dB THD to 20 kHz
- Calibrated Attenuator
- 10 Hz to 110 kHz

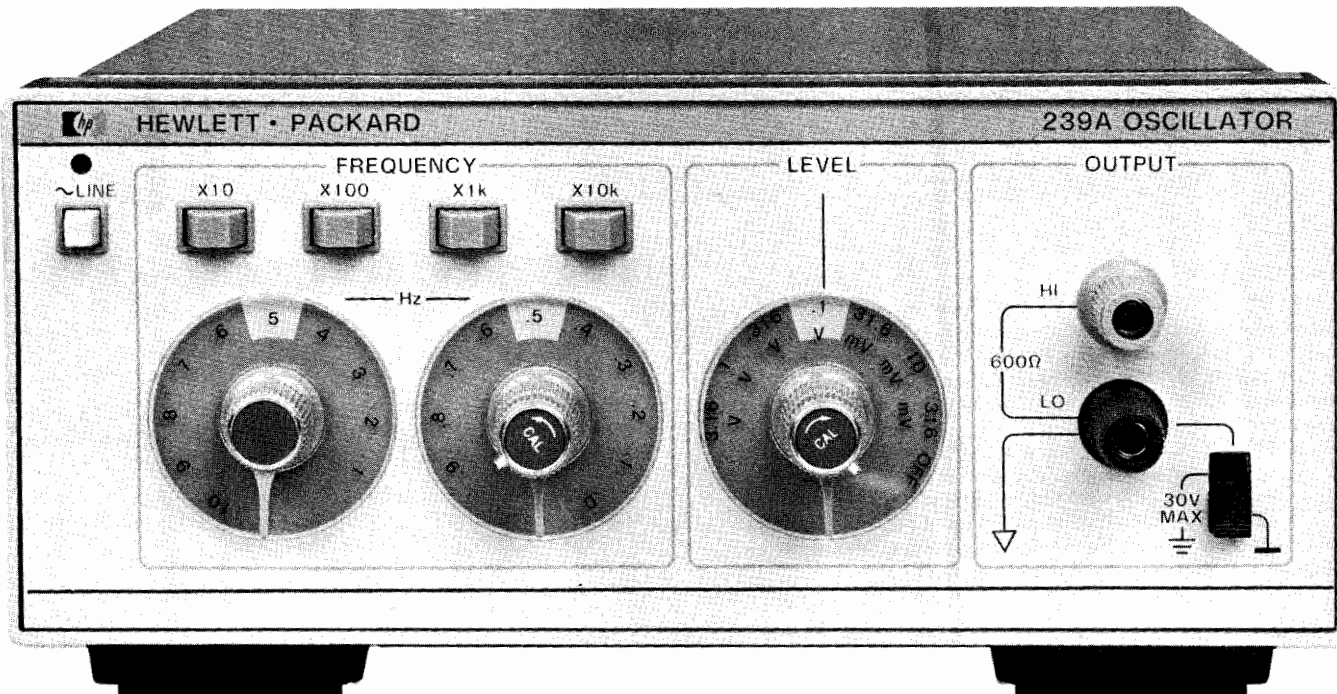

239A

Description

The HP 239A Oscillator provides a low distortion sine-wave output with > 3 Vrms amplitude from 10 Hz to 110 kHz and less than -95 dB (.0018%) total harmonic distortion (THD) to 20 kHz, increasing to -70 dB (.032%) at 110 kHz. Low THD performance combined with a 600Ω output that can be floated to 30 V peak makes the 239A an excellent general purpose audio test source.

Companion Oscillator for Distortion Measurements

The 239A Oscillator is electrically similar to the built-in oscillator used in the HP 339A Distortion Measurement Set and can be used in conjunction with the 339A where a remote audio source is needed for low distortion measurements such as broadcast studio through transmitter tests. Use of the 239A can improve the range of distortion measurements with earlier model analyzers. Its small size and weight makes the 239A convenient to use on the bench or easy to carry for remote tests.

Calibrated Output Attenuator

The accurately calibrated output allows measurements to be made without time consuming external calibration. The output level can be changed in 10 dB steps with ± 0.25 dB/step accuracy over a 60 dB range from a maximum calibrated output of + 10 dBV (3.16 Vrms). The output is continuously variable between steps down to a level of 1 mV with the amplitude vernier control.

Level flatness is ± 0.1 dB from 20 Hz to 20 kHz and less than ± 0.2 dB over the full frequency range.

Accurate Frequency Selection

Frequency selection with $\pm 2\%$ accuracy is easily made with 2-digit resolution using rotary knob tuning and the multiplier push-buttons. The frequency vernier control provides continuous frequency coverage between the second digit switch settings.

239A Specifications

Frequency: 10 Hz to 110 kHz in 4 overlapping decade ranges with 2-digit resolution. Frequency vernier provides continuous frequency coverage between second digit settings. Frequency accuracy: $\pm 2\%$ of selected frequency (with Frequency Vernier in CAL position).

Output level: Maximum calibrated output (1 kHz, 600Ω load): + 10 dBV (3.16 Vrms) $\pm .2$ dB

Output variable from < 1 mV to 3.16 Vrms into 600 ohms.

Output attenuator: Range: 60 dB in 10 dB steps; Accuracy: $\pm .25$ dB/10 dB step. Maximum Cumulative Error ± 1 dB; Output Vernier: > 10 dB range, continuously variable

Level flatness: 20 Hz to 20 kHz: $\leq \pm 0.1$ dB; 10 Hz to 110 kHz: $\leq \pm 0.2$ dB

Distortion ($\geq 600\Omega$ Load, ≤ 3 V Output): 10 Hz to 20 kHz: < -95 dB (0.0018%) THD; 20 kHz to 30 kHz: < -85 dB (0.0056%) THD; 30 kHz to 50 kHz: < -80 dB (0.01%) THD; 50 kHz to 110 kHz: < -70 dB (0.032%) THD

Output impedance: 600Ω $\pm 5\%$

Output terminals may be floated up to 30 V peak.

Operating environment: Temperature: 0°C to 50°C (+32°F to +122°F)

Humidity range: < 95%, 0°C to 40°C (+32°F to +104°F)

Storage temperature: -40°C to +75°C (-40°F to +167°F)

Power: 100/120/220/240 V, +5%, -10%, 48 to 66 Hz, 10 VA max.

Weight: Net 2.5 kg (5.5 lbs.); Shipping 3.9 kg (8.5 lbs.)

Size: 213 mmW x 88 mm H x 269 mm D (8.4" x 3.5" x 10.6")

239A Oscillator

\$675

OSCILLATORS

4 Hz to 2 MHz Sine, Square Wave Oscillators

Models 209A, 204C & 204D

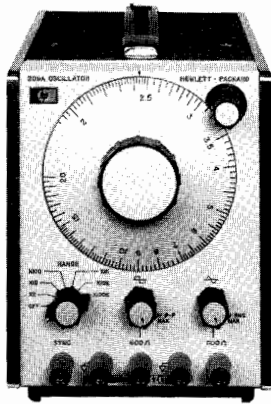

209A

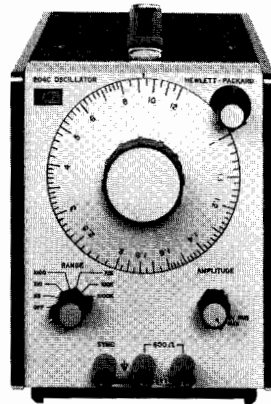

204C

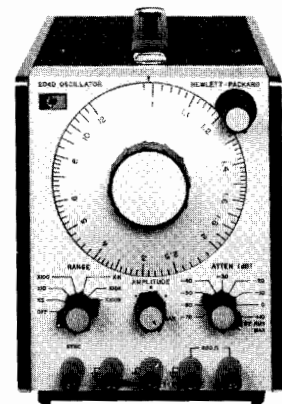

204D

Description

The HP 209A is a small, lightweight, sine/square oscillator. Stable, accurate signals can be synchronized with an external source over a frequency range from 4 Hz to 2 MHz. Separately adjustable sine/square outputs are located on the front panel. Distortion and flatness can be minimized at low frequencies by a rear panel low distortion mode switch.

The HP 204C is a small, lightweight capacitive-tuned oscillator. Interchangeable power packs, line or rechargeable batteries make this instrument ideal for both field and laboratory use.

The HP 204D Oscillator is identical to the 204C with the addition of an 80 dB attenuator and vernier. The attenuator with the vernier provides excellent output amplitude settability.

209A Specifications

Frequency: 4 Hz to 2 MHz in 6 ranges.

Dial accuracy: $\pm 3\%$ of frequency setting.

Flatness at maximum output into 600 Ω load, 1 kHz reference

Low distortion mode	+1%	$\pm 0.5\%$	$\pm 1\%$	$\pm 5\%$
Normal mode	+5%, -1%	$\pm 0.5\%$	$\pm 1\%$	$\pm 5\%$
	4	100	300 k	1 M
				2 M (Hz)

Distortion: 200 Hz to 200 kHz, 0.1% (-60 dB); 4 Hz to 200 Hz, <0.2% (-54 dB); 200 kHz-2 MHz, <1% (-40 dB).

Hum and noise: <0.01% of input.

Output Characteristics Sine Wave

Output voltage: 5 V rms (40 mW) into 600 Ω ; 10 V open circuit.

Output impedance: 600 Ω .

Output control: >26 dB range continuously adjustable.

Output balance: >40 dB below 20 kHz. Output can be floated up to ± 500 V peak between output and chassis ground.

Output Characteristics Square Wave

Output voltage: 20 V p-p open circuit symmetrical about 0 V. Output can be floated up to ± 500 Vp.

Rise and fall time: <50 ns into 600 Ω . Symmetry: $\pm 5\%$.

Output impedance: 600 Ω .

Synchronization

Sync output: sine wave in phase with output; 1.7 V rms, >1 V rms, 50 kHz to 2 MHz into 10 Kohm shunted by 100 pF.

Sync input: same as 204C.

204C Specifications

Frequency: 5 Hz to 1.2 MHz in 6 overlapping ranges.

Dial accuracy: $\pm 3\%$ of frequency setting.

Flatness at maximum output into 600 Ω load, 1 kHz reference

Low distortion mode	$\pm 1\%$	$\pm 0.5\%$	$\pm 1\%$
Normal mode	+5%, -1%	$\pm 0.5\%$	$\pm 1\%$
	5	100	300 k
			1.2 M (Hz)

Distortion: 30 Hz to 100 kHz, 0.1% (-60 dB); 5 Hz to 30 Hz, <0.6% (-44 dB); 100 kHz-1.2 MHz, linearly derated to <1%.

Hum and noise: <0.01% of output.

Output Characteristics

Output voltage: >2.5 V rms (10 mW or +10 dBm) into 600 Ω ; >5 V rms open circuit.

Output impedance: 600 Ω .

Output control: >40 dB range; continuously adjustable.

Output balance: >40 dB below 20 kHz. Can be floated up to ± 500 V peak between output and chassis ground.

Synchronization

Sync output: sine wave in phase with output; >100 mV rms into <100 pF over entire range; impedance 10 k Ω .

Sync input: oscillator can be synchronized to external signal. Sync range, the difference between sync frequency and set frequency, is a linear function of sync voltage. $\pm 1\%/V$ rms for sine wave with a maximum input of ± 7 V peak (± 5 V rms).

204D Specifications

(Identical to 204C except "output control" is replaced by the following):

Output Attenuator

Range: 80 dB in 10 dB steps.

Overall accuracy: ± 0.3 dB, +10 dB through -60 dB ranges; ± 0.5 dB on -70 dB range.

Output vernier: >10 dB range, continuously adjustable.

General

Operating temperature: Specifications are met from 0°C to 55°C.

Power: standard: AC-line 115 V or 230 V $\pm 10\%$, 48 Hz to 440 Hz, <7 VA max. Opt. 002: line/rechargeable batteries 115V or 230V $\pm 10\%$, 48 Hz to 440 Hz, <7 VA max. 22 hours operation per recharge.

Size: 155 mm H (without removable feet) \times 130 mm W \times 203 mm D (6.1" \times 5.1" \times 8").

Weight: net 2.7 kg (6 lb). Shipping, 3.6 kg (8 lb).

Options and Accessories

Option 002, 204 C/D (for rechargeable batt/AC-line) add \$100

00204 - 80003 Rechargeable battery/AC power pack \$250

for 204C/D

11075A Instrument case \$180

5060 - 8762 Rack adapter frame \$72.50

Ordering Information

209A Sine, square wave oscillator \$725

204C Sine wave oscillator \$600

204D Sine wave oscillator \$700

Price

OSCILLATORS

10 Hz to 10 MHz Test Oscillators

Models 651B, 652A, 654A

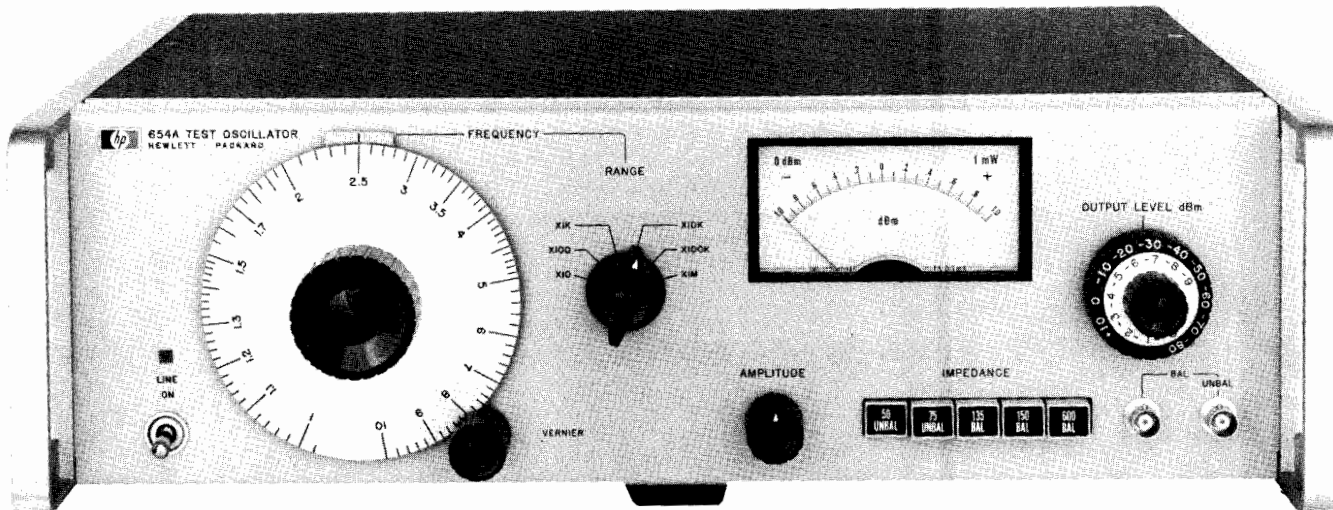

654A

Specifications & General Information

MODEL NO.	651B	652A	654A
Description	Amplitude and frequency stability of this solid state capacitance-tuned test oscillator provides high quality signals for general purpose lab or production measurements.	Similar to Model 651B. HP's Model 652A offers an expandable output monitor for amplitude control to 0.25% across its entire frequency band for greater output and resetability.	Similar to the 651B Test Oscillator, HP's 654A has balanced outputs of 135 Ω , 150 Ω , and 600 Ω , automatic leveling over entire frequency range, and expanded meter.
Frequency Range	10 Hz to 10 MHz, 6 bands.		
Frequency Accuracy	$\pm 2\%$, 100 Hz to 1 MHz; $\pm 3\%$, 10 Hz to 100 Hz and 1 MHz to 10 MHz.		$\pm 2\%$ 100 Hz to 5 MHz; $\pm 3\%$ 10 Hz to 100 Hz; $\pm 4\%$ 5 MHz to 10 MHz.
Frequency Response (Flatness)	$\pm 2\%$, 100 Hz to 1 MHz; $\pm 3\%$, 10 Hz to 100 Hz; ($\pm 4\%$, 1 MHz to 10 MHz applies only at 50 Ω or 75 Ω output and amplitude readjusted to a reference on the output monitor.)	$\pm 0.25\%$, 3 V and 1 V range; $\pm 0.75\%$, 0.3 V to 0.3 mV range; $\pm 1.75\%$, 0.1 mV range. (Amplitude readjusted using expanded scale on output monitor.)	(± 10 dBm and 0 dBm) $\pm 0.5\%$ from 10 Hz to 10 MHz for unbalanced outputs and 10 Hz to 5 MHz for 135 Ω and 150 Ω outputs, and 10 Hz to 1 MHz for 600 Ω output.
Distortion	<1%, 10 Hz to 2 MHz; <2%, 2 MHz to 5 MHz; <4%, 5 MHz to 10 MHz.		10 Hz to 1 MHz, >40 dB below fundamental; 1 MHz to 10 MHz, >34 dB below fundamental.
Output	3.16 V into 50 Ω or 600 Ω ; 6.32 V open circuit. 0.1 mV to 3.16 V full scale. 10 steps in 1, 3, 10 sequence; -70 dBm to +23 dBm (50 Ω output) full scale. 10 dBm per step; 20 dB coarse and fine adjustable amplitude control.		+11 dBm to -90 dBm, 10 dB and 1 dB steps with adjustable ± 1 dB meter range, calibrated for each impedance of 50 Ω and 75 Ω unbalanced and 135 Ω , 150 Ω and 600 Ω balanced.
Output Monitor (Monitor's Level at input of attenuator)	Top scale calibrated in volts, bottom scale in dB. Accuracy $\pm 2\%$ of full scale.	Same as 651B plus Expand Scale which expands reference voltage of the normal scale from 0.9 to 1.0 or 2.8 to 3.2	± 1 dBm with full scale with 0.02 dB resolution. Accuracy ± 0.05 dB.
Output ^a Connectors	BNC connectors.		
Attenuator	90 dB range in 10 dB steps: ± 0.075 dB, -60 dBm to +20 dBm; ± 0.2 dB, -70 dBm to -60 dBm.		99 dB range in 10 dB and 1 dB steps; $\pm 1.5\%$ (0.15 dB) except $\pm 10\%$ (1 dB) at output levels below 60 dBm at frequencies >300 kHz.
Temperature Range	0°C to +50°C (32°F to 122°F).		
Power	115V $\pm 10\%$, 48 Hz to 400 Hz; 230 V $\pm 10\%$ 48 to 66 Hz; 35 VA max.		
Weight	Net, 7.6 kg (17 lb). Shipping, 9.90 kg (22 lb).		Net, 9.4 kg (21 lb). Shipping, 11.8 kg (26 lb).
Dimensions	133 mm H x 425 mm W x 286 mm D (5.21" x 16.75" x 11.25").		
PRICE	\$1325	\$1525	\$1700

^aMaximum dc voltage that can be applied to output: $< \pm 3$ V p.

OSCILLATORS

10 Hz to 1 MHz Digital Oscillator

Model 4204A

- 0.2% frequency accuracy
- Accurate 80 dB output attenuator
- 0.01% frequency repeatability
- Excellent stability
- Flat frequency response



Description

Hewlett-Packard's 4204A Digital Oscillator provides accurate, stable test signals for both laboratory and production work. This one instrument does the job of an audio oscillator, an ac voltmeter, and an electronic counter when an accurate frequency source of known amplitude is required.

Any frequency between 10.0 Hz and 999.9 kHz can be digitally selected with an in-line rotary switch to four significant figures. As many as 36,900 discrete frequencies are available. Infinite resolution is provided by one vernier control, which also extends the upper frequency limit to 1 MHz. Frequency accuracy is better than $\pm 0.2\%$ and repeatability is typically better than $\pm 0.01\%$.

A built-in high impedance voltmeter measures output. The meter is calibrated to read volts or dBm into a matched 600 ohm load. (0 dBm = 1 mW into 600 Ohms.) The output attenuator has an 80 dB range, adjustable in 10 dB steps with a 20 dB vernier. Maximum output power can be increased to 10 volts (22 dBm) into 600 Ohms or 20 volts open circuit.

Frequency response is flat with less than $\pm 3\%$ variation over the entire frequency range at any attenuator setting. Frequency stability is better than 10 parts in 10^6 per minute.

Specifications

Frequency range: 10 Hz to 1 MHz, 4 ranges.

Frequency accuracy: $\pm 0.2\%$ or ± 0.1 Hz (at 25°C).

Frequency stability

$\pm 10\%$ line voltage variation: less than $\pm 0.01\%$.

Change of frequency with temperature: $< \pm 100$ ppm/°C.

Drift: < 10 ppm/minute.

Frequency response: flat within $\pm 3\%$, 9,999 kHz ref. (25°C $\pm 5^\circ$ C).

Output: 10 V (22 dBm) into 600 ohms (160 mW), 20 V open circuit.

Output attenuator: 80 dB in 10 dB steps: $< \pm 0.5$ dB error.

Output monitor: voltmeter monitors level at input of attenuator in volts or dB.

Accuracy: $\pm 2\%$ of full scale.

Flatness: $\pm 1\%$ at full scale, 10 Hz to 500 kHz; $\pm 2\%$ at full scale, 500 kHz to 1 MHz.

Distortion: less than 0.3%, 30 Hz to 100 kHz. Less than 1%, 10 Hz to 600 kHz. Less than 1.2%, 10 Hz to 1 MHz.

Hum and noise: less than 0.05% of output.

Temperature range: 0°C to +50°C.

Power: 115 V/230 V switch, $\pm 10\%$, 10 VA, 50 to 60 Hz.

Weight: net, 8.5 kg (19 lb). Shipping, 11 kg (28 lb).

Size: 141 mm H x 426 mm W x 336 mm D (5½" x 16¾" x 13¼").

Accessories Available

11000A Cable: dual banana plugs \$20

11001A Cable: banana plug to BNC male connector \$20

11004A Line Matching Transformer has a frequency response of 5 kHz to 600 kHz providing fully balanced outputs for 135 or 600 ohms. \$110

11005A Line Matching Transformer has a frequency response of 20 Hz to 45 kHz providing full balanced output into 600 ohms. \$220

16252A Matching Transformer has a frequency response of 10 kHz to 1 MHz providing unbalanced 75 ohm output, terminated in UG-657/U female BNC connector. \$160

Options

001: 4204A Output Monitor top scale calibrated in dBm/600Ω. Bottom scale calibrated in volts add \$33

908: Rack Flange Kit add \$22

910: Extra Manual add \$11

4204A Digital Oscillator

\$2265

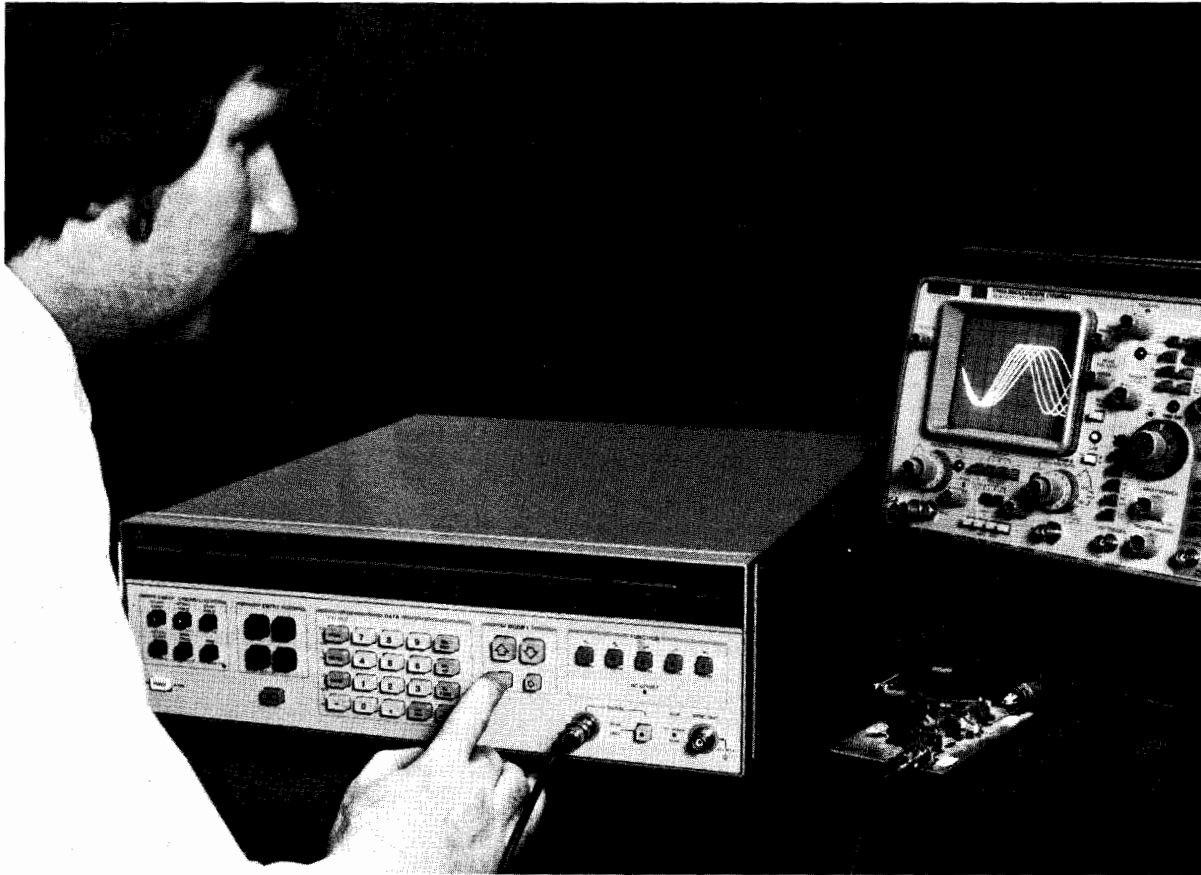

Today's measurement needs are placing increasingly stringent requirements on signal sources for greater frequency resolution and stability. Narrowband component testing, satellite and terrestrial communications, local oscillator and automatic test systems are only a few of the many applications that continually require higher precision sources.

Square waves, triangle waves and pulses are signals typically associated with non-synthesized sources. This situation is changing. Precision signals of these types are finding important applications in mechanical, civil and environmental engineering.

Increased amplitude accuracy and resolution are also must requirements in many applications. The telecommunication industry's Frequency Division Multiplex (FDM) systems require high amplitude accuracy and resolution (0.01 dB) as well as high frequency resolution and stability. These requirements are becoming commonplace in R & D and production test situations.

With technology continuing to reduce the cost of synthesis techniques, the traditional oscillator is giving way to a synthesizer as the primary signal in multi-function sources.

Frequency Synthesis Techniques

Synthesis techniques fall into two major categories: direct and indirect. In this section, only indirect techniques are used. Traditional approaches to indirect synthesis require a phase locked loop for every decade (digit) of frequency resolution required. This does provide adequate performance but is expensive in component parts, leading to an expensive product. A new technique has been developed by Hewlett-Packard which avoids

this problem, enabling a single phase locked loop to offer multidigit resolution. The process is called Fractional Frequency Synthesis or Fractional N—a method of relating the PLL output VCO frequency to the crystal reference frequency by other than an integer N. Up to 11 digits of frequency resolution can be achieved from a single phase locked loop with this new technique. Significant cost savings and increased reliability result.

Signal Quality

The common specifications which describe signal sources include in addition to frequency range and resolution, amplitude range and resolution, distortion and stability. The two

primary additional specifications pertinent to the synthesizer are phase noise and spurious content.

Phase noise: Phase noise describes the short term frequency stability of a signal source. Internal short-term frequency fluctuations will produce phase modulation sidebands about the nominal frequency. Phase noise is a measure of the magnitude of these sidebands. There are two common methods of specifying phase noise—a sideband plot and integrated phase noise.

The first method expresses phase noise as the ratio of the power in one phase noise sideband per hertz of bandwidth to the total

Function Generator Summary

FUNCTIONS	FREQUENCY RANGE	OUTPUT	INST.	PAGE
~ ~ ~ ~ ~	0.01 mHz to 10 MHz	560 mW	3310A/B	379
~ ~ ~ ~ ~	0.1 mHz to 10 MHz	250 mW	3312A ¹	381
~ ~ ~ ~ ~	0.1 Hz to 10 MHz	20 mW	3311A	380
~ ~ ~ ~ ~	0.1 Hz to 10 MHz	250 mW	3325A ²	382
~ ~ ~ ~ ~	1 Hz to 10 MHz	32 V	8111A ³	390
~ ~ ~ ~ ~	0.1 Hz to 10 MHz	32 V	8116A ⁴	391
~ ~ ~ ~ ~	0.1 Hz to 10 MHz	20 V	8165A ⁵	392

¹Two Generators, AM, FM, Sweep, Trigger/Gate

²Synthesizer/Function Generator, AM, PM, Sweep, HP-IB; Opt. 002, 400 mW to 1 MHz.

³Pulse/Function Generator, Haversine/Triangle, VCO, Counted Burst

⁴Pulse/Function Generator, Haversine/Triangle, Sweep, VCO, Counted Burst, AM, FM, PWM, HP-IB

⁵Synthesizer/Function Generator, AM, FM, Sweep, Trigger/Gate, Burst, HP-IB



FUNCTION GENERATORS & FREQUENCY SYNTHESIZERS

General Information (Cont.)

signal power. A sideband plot of the phase noise graphically displays the magnitude and frequency components (spectral density) of the phase noise.

Integrated phase noise is the ratio of the rms value of the total phase noise sidebands in a 30 kHz bandwidth around the carrier (excluding ± 1 Hz) to the power of the carrier.

For a detailed treatment of the subject of phase noise refer to Application Note #207.

Spurious signals: Spurious signals are discrete, non-harmonically related signals appearing in the output. The spurious output specification is the maximum level, in dB below the carrier, of any spurious signal.

Synthesizers

Hewlett-Packard offers a wide range of high quality frequency synthesizers covering the frequency range of DC to 18 GHz. In addition to being high performance synthesizers, they incorporate many additional features which allow them to fulfill the needs for either bench or programmable precision signal sources or as versatile programmable signal generators.

Synthesized Signal Generators

The combined frequency ranges of the HP 8660A/C, 8662A, and 8672A Synthesized Signal Generators span 10 kHz to 18 GHz. These generators couple the frequency accuracy and stability of synthesizers with the modulation capability and precise, calibrated, wide-range level control of high quality signal generators. In addition, each of these generators offer HP-IB remote control of frequency, level, and modulation.

Synthesized Level Generator

The HP 3335A is a synthesized level generator covering the range of 200 Hz to 80 MHz. This instrument is ideal as a stand-alone generator with synthesizer stability or as a companion generator for the HP 3745A/B SLMS and 3586 A/B/C selective level meter. It offers the traditional range of connectors and output impedances, balanced and unbalanced, required by the telecommunications industry. The new 3336A is a 21 MHz synthesized level generator with a similar set of telecommunications features. It too, is ideal as a stand-alone generator or as a companion for HP's new 3586A Selective Level Meter. For more information on these generators, refer to the Telecommunications section.

Sweep Capability

The 3330B, 3335A, 8660C, and 8662A are among the most linear sweepers ever built. Keyboard control of built-in microprocessors gives these instruments digital sweep (a point-by-point sweep with frequency synthesizer accuracy).

The 3325A and the 3336A offer a phase continuous rather than digital sweep over the full frequency range of their output.

The 3330B also offers digital amplitude sweeps. Amplitude can be swept in increments as small as 0.01 dB to test level sensitive circuits like voltage-controlled oscillators and automatic gain control loops.

Synthesizer/Function Generators

The HP 3325A is a function generator whose functions are derived from a primary synthesized oscillator. It provides a high pu-

rity synthesized sinewave from .000001 Hz to 21 MHz, precision squarewaves to 11 MHz, linear ramps and triangle waveforms to 11 kHz, 11 digit resolution ($1 \mu\text{Hz} < 100$ kHz), wideband phase continuous sweep, and HP-IB programmability. The low price makes the 3325A an excellent choice for low frequency systems or bench applications.

Function Generator (non-synthesized)

The function generator is a versatile, multi-waveform signal source capable of very wide frequency coverage. Available are functions ranging from modulation (3312A), sweep (3312A), and trigger/gated waveforms (3310A/B, 3312A). These units provide the full range of commonplace waveforms such as sinewaves, square waves, triangle and ramp waves. The function generator is an indispensable general purpose signal source for production testing, instrument repair, and the electronics laboratory. Diverse fields of applications in which the function generator is being used include medical research, education, chemical, communications, geophysics, industrial control, military, and aerospace.

Programmability (HP-IB)

The 3320B, 3325A, 3335A, 3336 A/B/C, 8660A/C, 3330B, 8165A, 8662A, 8671A, and 8672A are programmable via the Hewlett-Packard Interface Bus (HP-IB), Hewlett-Packard's implementation of IEEE STD 488-1975. Multiple signal sources interfaced to the same interface bus each may be independently programmed for different functions or frequencies.

Synthesizer Summary

HP Model	Frequency Range	Frequency Resolution	Frequency Stability	Level Range dBm - 50 Ω	Level Resolution	Remote Control	Other Features*
3320B (Pg. 384)	DC-13 MHz 5 ranges	0.01 Hz to 10 kHz (4 digits)	10^{-7} /day	-73 to +27	0.01 dB (4 digits)	Freq. & Ampl.	1, 8
3325A*** (Pg. 382)	DC-21 MHz (sine) DC-11 MHz (square)	.000001 Hz or .001 Hz (11 digits)	5×10^{-6} /yr	-56.02 to +23.98 (sine)	.01 dB or .001 mV to .01V (4 digits)	Freq. Ampl. Sweep & Phase	8, 11, 12, 13
3330B (Pg. 385)	DC-13 MHz	0.1 Hz (9 digits)	10^{-8} /day	-87 to +13	0.01 dB (4 digits)	Freq. & Ampl.	2, 3, 4, 6, 8
3335A (Pg. 386)	200 Hz-80 MHz	.001 Hz	10^{-6} /day	-87 to +13	0.01 dB (4 digits)	Freq. & Ampl.	2, 3, 8
3336A/B/C (Pg. 388)	DC-21 MHz (Pg. 370)	.001 Hz or 11 digits	1.5×10^{-8} /day	-71 to +8	0.01 dB	Freq. Ampl. Sweep & Phase	8, 11, 12, 13
8660A/C** (Pg. 400)	10kHz to 2600 MHz (3 plug-ins)	1 Hz or 2 Hz (10 digits)	3×10^{-8} /day	-146 to +13	Local: 10 dB steps plus Vernier Remote: 1dB Steps	Freq., Ampl. & Modulation	8660A: 5, 7, 8 8660C: 3, 5, 7, 8
8662A** (Pg. 398)	10 kHz-1280 MHz	0.1 Hz or 0.2 Hz (11 digits)	5×10^{-10} /day	-139.9 to +13	0.1 dB (4 digits)	Freq. Ampl. Modulation & Sweep	3, 8, 14
8671A (Pg. 415)	2 to 6.2 GHz	1 kHz	5×10^{-10} /day	>+ 8	—	Freq., FM Modulation	8, 9
8672A** (Pg. 416)	2 to 18 GHz	1, 2, 3 kHz	5×10^{-10} /day	-120 to +3	Local: 10 dB steps plus Vernier Remote: 1 dB Steps	Freq., Ampl. & Modulation	8, 10
8165A (Pg. 392)	1 mHz to 50 MHz	4 digits	1×10^6 /day	10.0 mV to 20 V P-P	3 digits	Modulation & Trigger	3, 8, 10

* Other features: (1) 10^{-8} /day freq. stability optional, (2) 5×10^{-10} /day, (3) digital freq. sweep, (4) digital ampl. sweep, (5) internal AM/FM, ϕ M, (6) External AM, (7) 3×10^{-9} /day stability Opt. 001 (8) HP-IB, (9) External FM, (10) External AM & FM, (11) 5×10^{-9} /week stability optional, (12) external AM & ϕ M, (13) phase continuous sweep, (14) Internal & External AM & FM.

** The 8660A/C, 8662A and 8672A are synthesized signal generators. They are discussed in detail in the section labeled "Signal Generators."

*** The 3325A Synthesizer/Function Generator includes squarewaves, positive and negative ramps, and triangle waveforms in addition to sinewaves.

FUNCTION GENERATORS & FREQUENCY SYNTHESIZERS

0.0005 Hz to 5 MHz Function Generators

Model 3310A/B

379

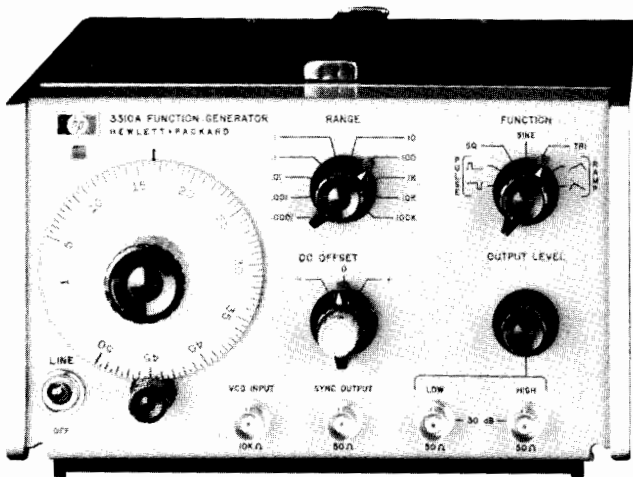

3310A

Description

The 3310A Function Generator is a compact voltage-controlled generator with 10 decades of range. Ramp and pulse functions are available in addition to sine, square and triangle. DC offset and external voltage control provide wide versatility. A fast rise time sync output is provided. Aspect ratio of nonsymmetrical function is 15%/85%.

The 3310B has all the features of the standard 3310A plus single and multiple cycle output capability.

3310A Specifications

Output waveforms: sinusoidal, square, triangle, positive pulse, negative pulse, positive ramp and negative ramp. Pulses and ramps have a fixed 15% or 85% duty cycle.

Frequency range: 0.0005 Hz to 5 MHz in 10 decade ranges.

Sine Wave Frequency Response

0.0005 Hz to 50 kHz: $\pm 1\%$; 50 kHz to 5 MHz: $\pm 4\%$. Reference, 1 kHz at full amplitude into 50 Ω .

Dial Accuracy

0.0005 Hz to 500 kHz all functions: $\pm (1\% \text{ of setting} + 1\% \text{ of full scale})$.

500 kHz to 5 MHz sine, square and triangle: $\pm (3\% \text{ of setting} + 3\% \text{ of full scale})$.

500 kHz to 5 MHz pulse and ramps: $\pm (10\% \text{ of setting} + 1\% \text{ of full scale})$.

Maximum output on high: $> 30 \text{ V p-p}$ open circuit; $> 15 \text{ V p-p}$ into 50 Ω (except for pulses at frequency $> 2 \text{ MHz}$).

Pulse (frequency $> 2 \text{ MHz}$): $> 24 \text{ V p-p}$ open circuit; $> 12 \text{ V p-p}$ into 50 Ω .

Minimum output on low: $< 30 \text{ mV p-p}$ open circuit; $< 15 \text{ mV p-p}$ into 50 Ω .

Output level control: range $> 30 \text{ dB}$. High and low outputs overlap for a total range of $> 60 \text{ dB}$; low output is 30 dB down from high output.

Sine Wave Distortion

0.0005 to 10 Hz: $> 40 \text{ dB}$ (1%).

10 Hz to 50 kHz (on 1 k range): $> 46 \text{ dB}$ (0.5%).

50 kHz to 500 kHz: $> 40 \text{ dB}$ (1%).

500 kHz to 5 MHz: $> 30 \text{ dB}$ (3%).

Square wave and pulse response: $< 30 \text{ ns}$ rise and fall times at full output.

Triangle and ramp linearity: 0.0005 Hz to 50 kHz, $< 1\%$.

Impedance: 50 Ω .

Sync

Amplitude: $> 4 \text{ V p-p}$ open circuit, $> 2 \text{ V p-p}$ into 50 Ω .

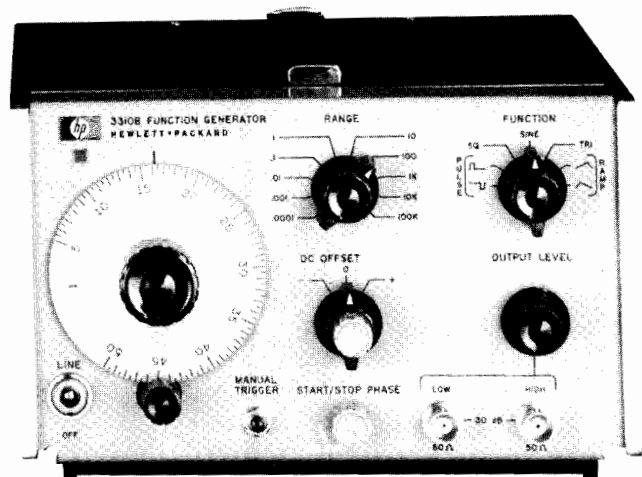

3310B

DC Offset

Amplitude: $\pm 10 \text{ V}$ open circuit, $\pm 5 \text{ V}$ into 50 Ω (adjustable).

Note: max V ac peak + V dc offset is $\pm 15 \text{ V}$ open circuit, $\pm 7.5 \text{ V}$ into 50 Ω .

External frequency control: 50:1 on any range.

Input requirement: with dial set to low end mark, a positive ramp of 0 to $+10 \text{ V} \pm 1 \text{ V}$ will linearly increase frequency 50:1. With dial set at 50, a linear negative ramp of 0 to $-10 \text{ V} \pm 1 \text{ V}$ will linearly decrease frequency 50:1. An ac voltage will FM the frequency about a dial setting within the limits $(1 < f < 50) \times \text{range setting}$.

Linearity: ratio of output frequency to input voltage ($\Delta F/\Delta V$) will be linear within 0.5%.

Sensitivity: approximately 100 mV/minor division.

Input impedance: 10 k Ω .

General

Power: 115 V or 230 V $\pm 10\%$, 48 Hz to 440 Hz, $< 20 \text{ VA}$ max.

Size: 114 mm H (without removable feet), 197 mm W, 203 mm D (4.5" x 7.8" x 8").

Weight: net, 2.7 kg (6 lb); shipping, 4.5 kg (10 lb).

Accessories Available

For rack mounting, order HP 5060-8762 Rack Adapter Frame; 5060-8540, 5060-8760 Filler panels.

3310B Specifications

Same as 3310A with the following additions:

Modes of operation: free run, single cycle, multiple cycle.

Triggered frequency range: 0.0005 Hz to 50 kHz (usable to 5 MHz in normal mode).

Single cycle: ext trigger (ac coupled) requires a positive-going square wave or pulse from 1 V p-p to 10 V p-p. The triggering signal can be dc offset, but $(V \text{ ac peak} + V \text{ dc}) \leq \pm 10 \text{ V}$ ext gate (dc coupled) will trigger a single cycle on any positive waveform $\geq 1 \text{ V}$ but $\leq 10 \text{ V}$ which has a period greater than the period of the 3310B output, and a duty cycle less than the period of the 3310B output. The gate signal cannot exceed 10 V.

Multiple cycle: manual trigger will cause the 3310B to free run when depressed. When the trigger button is released, the waveform will stop on the same phase as it started. Ext. gate will cause the 3310B to free run when the gate is held at between $+1$ and $+10 \text{ V}$. When the gate signal goes to zero, the 3310B will stop on the same phase as it started.

Start-stop phase: the start-stop phase can be adjusted over a range of approximately $\pm 90^\circ$.

Ordering Information

3310A Function Generator

3310B Function Generator

Price

\$975

\$1075

**This specification applies on the X.0001 to X 1 k range only.

FUNCTION GENERATORS & FREQUENCY SYNTHESIZERS

0.1 Hz to 1 MHz

Model 3311A

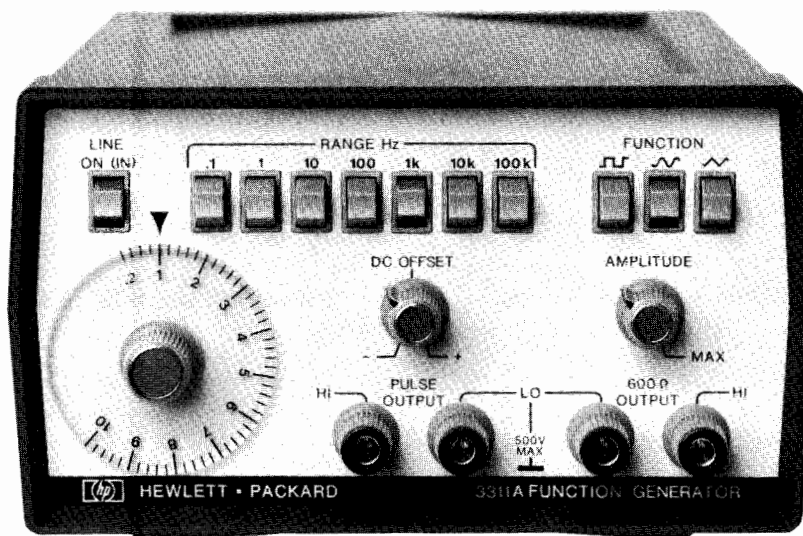

Description

The 3311A Function Generator offers wide functional capability at a modest price. This compact unit has seven decades of range from 0.1 Hz to 1 MHz. Pushbutton range and function selection add convenience to versatility. Added features normally not found on function generators in this price range are 10:1 voltage control and a separate pulse output suitable for synchronization or driving TTL logic circuits.

Output

Ten V p-p into 600Ω (20 V p-p O.C.). This output may be attenuated by >30 dB by a variable attenuator and offset by ±5 V. The DC offset allows the sine, square, and triangle functions to be positioned to the most desired level. This feature adds to the usefulness of all three functions.

VCO

The DC coupled voltage control allows the use of an external source to sweep the 3311A > 10:1 in frequency.

Pulse Output

A separate TTL compatible pulse output provides current sinking for up to 20 TTL loads. The pulse has a 15/85 aspect ratio with a <25 ns rise time.

Specifications

Waveforms: sinusoid, square, triangle, and positive pulse.

Frequency range: 0.1 Hz to 1 MHz in seven decade ranges.

Dial accuracy: ±5% of full scale.

Isolation: using an external supply, outputs may be floated up to ±500 V relative to the instrument case (earth ground).

600 Ohm Output

Maximum output amplitude: 20 V p-p open circuit; 10 V p-p into 600Ω.

Amplitude control: continuously variable, >30 dB range. DC off-

set: up to ±10 V open circuit, ±5 V into 600Ω, continuously adjustable and independent of amplitude control. Maximum V_{ac} peak + V_{dc} offset without clipping is ±10 V open circuit, ±5 V into 600Ω.

Output impedance: 600Ω ± 10%.

Sine wave amplitude flatness: within ±3% of 10 kHz reference (maximum output amplitude) to 100 kHz, ±6% to 1 MHz.

Sine wave total harmonic distortion: <3% (maximum output amplitude).

Triangle linearity: deviation <1% from best straight line at 100 Hz (maximum output amplitude).

Square wave transition time: rise time: <100 ns; fall time: <100 ns.

Square wave time axis symmetry error: ±2% maximum to 100 kHz.

Pulse Output

Output amplitude: >3 V positive (open circuit) TTL compatible.

Duty cycle: 13.5% to 16.5% of the total period.

Transition times: <25ns.

External Frequency Control

VCO range: >10:1 on any frequency range.

Input requirement: with frequency dial set to 1.0, a linear ramp of 0.0 V to -10 V ±2 V will linearly increase frequency >10:1

Input impedance: 10 kΩ ± 10% in parallel with <60 pFd.

General

Operating temperature: 0°C to 55°C; specifications apply from +15°C to +35°C.

Storage temperature: -40°C to +75°C.

Power: 100/120/220/240 V -10%, +5% switchable: 48 Hz to 66 Hz; ≤12 VA.

Size: 89 mm H x 159 mm W x 248 mm D (3.5" x 6.3" x 9.8").

Weight: net, 1.5 kg (3.3 lb); shipping, 2.5 kg (5.5 lb).

Rack Mount Kits: 10851A for one 3311A, 10852A for two.

3311A Function Generator

\$325

- Two Function Generators In One Instrument
- AM-FM, sweep, trigger, gate and burst

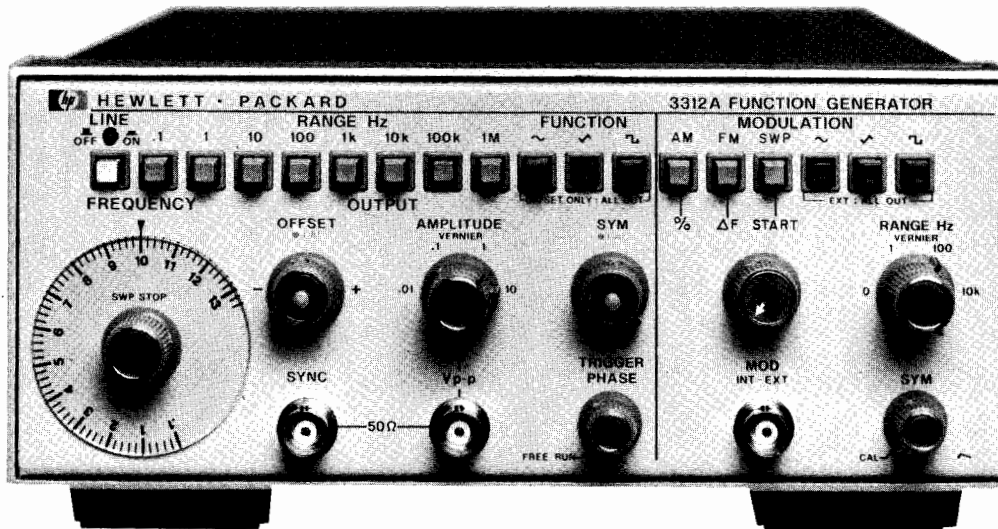

Description

Hewlett-Packard's 3312 A Function Generator combines two separate, independent function generators with a modulator section in one compact instrument.

The main generator can—via pushbutton control—be triggered by the modulation generator to provide sweep functions, AM, FM or tone burst.

Ten V p-p into 50 Ω provides adequate power for most applications. The output attenuator has a range of more than 10,000:1 so clean low-level signals from 10 V to 1 mV p-p into 50 Ω can be obtained. The main generator includes dc offset up to 10 volts p-p into 50 Ω .

Hewlett-Packard's 3312A is an effective low cost solution for generating a multitude of functions.

Specifications

Output waveforms: sine, square, triangle, \pm ramp, pulse, AM, FM, sweep, triggered and gated.

Frequency Characteristics

Range: 0.1 Hz to 13 MHz in 8 decades ranges.

Dial accuracy: $\pm 5\%$ of full scale.

Square wave rise or fall time (10% to 90%): <20 nsec.

Aberrations: <10%.

Triangle linearity error: <1% at 100 Hz.

Variable symmetry: 80:20:80 to 1 MHz.

Sine wave distortion: <0.5% (-46dB) THD from 10 Hz to 50 kHz. (10 kHz range maximum). >30 dB below fundamental from 50 kHz to 13 MHz.

Output Characteristics

Impedance: 50 $\Omega \pm 10\%$.

Level: 20 V p-p into open circuit, >10 V p-p into 50 Ω at 1 kHz.

Level flatness (sine wave): < $\pm 3\%$ from 10 Hz to 100 kHz at full rated output (1 kHz reference). < $\pm 10\%$ from 100 kHz to 10 MHz.

Attenuator: 1:1, 10:1, 100:1, 1000:1 and >10:1 continuous control.

Attenuator error: <5%.

Sync output: impedance: 50 $\Omega \pm 10\%$, >1 V p-p square wave into open circuit. Duty cycle varies with symmetry control.

DC offset: Variable up to ± 10 volts. Instantaneous ac voltage + Vdc offset cannot exceed ± 10 V (open circuit) or ± 5 V (terminated 50 ohm).

Modulation Characteristics

Types: internal AM, FM, sweep, trigger, gate or burst; external AM, FM, sweep, trigger, gate or burst.

Waveforms: sine, square, triangle, ramp or variable symmetry pulse.

Frequency range: 0.01 Hz to 10 kHz.

Output level: >1.0 V p-p into 10 k Ω .

Amplitude Modulation

Depth: 0 to 100%.

Modulation frequency: 0.01 Hz to 10 kHz (internal). DC to >1 MHz (external).

Carrier 3 dB bandwidth: <100 Hz to >5 MHz.

Carrier envelope distortion: <2% at 70% sine wave modulation with $f_c = 1$ MHz, $f_m = 1$ kHz.

External sensitivity: <10 V p-p for 100% modulation.

Frequency Modulation

Deviation: 0 to $\pm 5\%$ (internal).

Modulation frequency: internal: 0.01 Hz to 10 kHz; external: DC to >50 kHz.

Distortion: <-35 dB at $f_c = 10$ MHz, $f_m = 1$ kHz, 10% modulation.

Sweep Characteristics

Sweep width: >100:1 on any range.

Sweep rate: 0.01 Hz to 10 kHz, 90:10 ramp, and 0 Hz Range (provides manual setting of "Sweep Start" without modulation generator oscillating).

Sweep mode: repetitive linear sweep between start and stop frequency settings. Retrace time can be increased with symmetry control.

Ramp output: 0 to >-4 p-p into 5 k Ω .

Gate Characteristics:

Start/stop phase range: +90 $^\circ$ to -80 $^\circ$.

Frequency range: 0.1 Hz to 1 MHz (useful to 10 MHz).

Gating signal frequency range (external): DC to 1 MHz, TTL compatible.

External Frequency Control

Range: 1000:1 on any range.

Input requirement: with dial set at 10, 0 to -2 V $\pm 20\%$ will linearly decrease frequency >1000:1. An ac voltage will FM the frequency about a dial setting within the limits (0.1 < f < 10) x range setting.

Linearity: the frequency versus voltage curve will be linear within 0.5% over a 100:1 frequency range.

Input impedance: 2.8 k $\Omega \pm 5\%$.

General

Operating temperature: 0 $^\circ$ C to +55 $^\circ$ C; specifications apply from 0 $^\circ$ C to 40 $^\circ$ C.

Storage temperature: -40 $^\circ$ C to +75 $^\circ$ C.

Power: 100 V, 120 V, 220 V, 240 V +5%, -10%, switchable; 48 Hz to 440 Hz; ≤ 25 VA.

Size: 102 mm H x 213 mm W x 377 mm D (4" x 8.4" x 14.8").

Weight: net, 3.8 kg (8.4 lb). Shipping, 5.9 kg (13 lb).

3312A Function Generator

\$975

FUNCTION GENERATORS & FREQUENCY SYNTHESIZERS

1 μ Hz to 21 MHz Automatic Synthesizer

Model 3325A

- Function Generator
- Sweeper
- Programmable

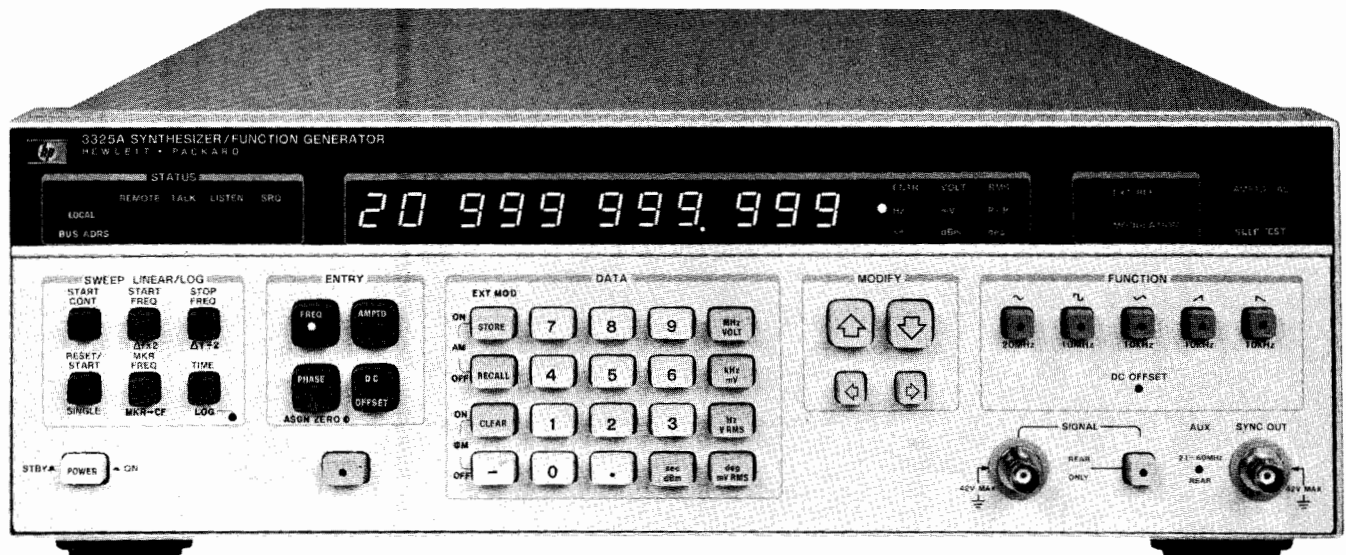

3325A



Description

The 3325A Synthesizer/Function Generator is an uncompromising, high performance synthesizer with 11 digit resolution, a function generator with precision waveforms, a wideband sweeper, and a fully programmable systems instrument.

Synthesizer

The 3325A is first with microhertz resolution below 100 kHz along with frequency coverage from .000001 Hz to 20.999 999 999 MHz. Signal purity, accuracy and stability are as good or better than earlier stand-alone HP synthesizers. Harmonics are 65 dB down below 50 kHz and you can externally modulate with AM and PM.

Function Generator

The 3325A is also a high performance function generator providing precision waveforms with synthesizer accuracy and resolution. Squarewaves to 10.999 999 999 MHz have 20 ns rise and fall times. Triangles and ramps with .05% linearity are available up to 10.999 999 999 kHz. All waveforms can be DC and phase offset.

A Wideband Sweeper

A major contribution is wideband phase continuous sweep, covering up to the full frequency range of each waveform. Sweep log or linear, single or continuous without the phase discontinuities usually associated with synthesizers. Phase lock loop testing is made easier.

Make convenient swept frequency network measurement on filters, amplifiers or any passive or active network. Use the TTL marker to check the frequency of points of interest on a swept frequency display desired. Use the convenient "zoom" functions $\Delta F \times 2$ and $\Delta F \div 2$ to quickly change the frequency span for the display desired.

Fully Programmable

All necessary functions are programmable on the HP-IB, including frequency, amplitude, all functions, phase and DC offset, modulation, all sweep parameters, amplitude cal and self-test, making the 3325A a very versatile and powerful addition to automatic test systems. The isolated interface combined with floating outputs and inputs and talk mode make the 3325A easy to use in Automatic Test Systems.

More Features

The phase of the output can be changed $\pm 719.9^\circ$ with $.1^\circ$ resolution. The phase is advanced (or retarded) with respect to the starting

phase. Two 3325A units can be phase locked together for dual phase output applications.

DC offset is capable of ± 4.5 VDC on the standard instrument. The high voltage option (Opt 002) allows AC voltages up to 40 Vpp and AC + DC up to ± 18 V Total (AC peak + DC).

Ten storage registers can be programmed with ten different combinations of function/parameter settings from the front panel, stored and then recalled.

The 3325A can display 11 digits of frequency and 4 digits of volts or millivolts from 1 mV to 10 volts peak to peak. Conversion to RMS or dBm is simple with the touch of a button.

New Technology

The 3325A provides unprecedented performance per dollar thanks to several major contributions from advances in HP technology. A single loop Fractional-N synthesis technique allows synthesizer accuracy with 11 digits of resolution, and as an added bonus... phase continuous frequency sweep. Fewer parts and integrated circuit technology make the difference. A unique method of triangle and ramp waveform generation provides excellent linearity. Add micro-processor control and Hewlett-Packard Interface Bus (HP-IB) operation and the result is more performance, flexibility and versatility on the bench, or in automatic test systems than previously available, and at a lower cost.

Specifications

Refer to the 3325A Data Sheet for complete specifications.

Waveforms

Sine, Square, Triangle, negative and positive Ramps

Frequency

Range:

Sine: 1 μ Hz to 20.999 999 999 MHz

Square: 1 μ Hz to 10.999 999 999 MHz

Triangle/ramps: 1 μ Hz to 10.999 999 999 kHz

Resolution: 1 μ Hz, < 100 kHz
1 mHz \geq 100 kHz

Aging rate: $\pm 5 \times 10^{-6}$ /year, 20° to 30°C

Warm-up time: 20 minutes to within specified accuracy



Main Signal Output (All Waveforms)

Impedance: 50 Ω

Connector: BNC; switchable to front or rear panel, nonswitchable with option 002, except by internal cable change.

Amplitude

Range: 1 mV to 10 V p-p in 8 amplitude ranges, 1-3-10 sequence (10 dB steps), into 50 Ω load.

Function	Sine		Square		Triangle/Ramps	
	min	max	min	max	min	max
Units Displayed						
peak-peak	1.000 mV	10.00 V	1.000 mV	10.00 V	1.000 mV	10.00 V
rms	0.354 mV	3.536 V	0.500 mV	5.000 V	0.289 mV	2.887 V
dBm (50 Ω)	-56.02	+23.98	-53.01	+26.99	-57.78	+22.22

Resolution: 0.03% of full range or 0.01 dB (4 digits).

Amplitude Accuracy: (without dc offset, relative to programmed amplitude and accuracy)

Sinewave amplitude accuracy:

1 mHz to 100 kHz: ± 1 dB, ≥ 3 Vpp; ± 2 dB, < 3 Vpp

100 kHz to 20 MHz: ± 4 dB, ≥ 3 Vpp; ± 6 dB, $.1 + 3$ Vpp

Squarewave amplitude accuracy:

1 mHz to 100 kHz: 1%, ≥ 3 Vpp; 2.2%, < 3 Vpp

100 kHz to 10 MHz: 11.1%, ≥ 3 Vpp; 13.7%, < 3 Vpp

Triangle amplitude accuracy:

1 mHz to 2 kHz: 1.5%, ≥ 3 Vpp; 2.7%, < 3 Vpp

2 kHz to 10 kHz: 5%, ≥ 3 Vpp; 6.2%, < 3 Vpp

Sinewave Spectral Purity

Phase noise: -60 dB for a 30 kHz band centered on a 20 MHz carrier (excluding ± 1 Hz about the carrier).

Spurious: All non-harmonically related output signals will be more than 70 dB below the carrier (60dB with DC offset), or less than -90 dBm, whichever is greater.

Sinewave harmonic distortion: Harmonically related signals will be less than the following levels (relative to the fundamental) at full output for each range:

Frequency Range	Harmonic Level
0.1 Hz to 50 kHz	-65 dB
50 kHz to 200 kHz	-60 dB
200 kHz to 2 MHz	-40 dB

Squarewave Characteristics

Rise/fall time: ≤ 20 ns, 10% to 90% at full output

Overshoot: $\leq 5\%$ of peak to peak amplitude, at full output

Settling time: < 1 μ s to settle to within .05% of final value.

Phase Offset

Range: $\pm 719.9^\circ$ with respect to arbitrary starting phase or assigned zero phase

Resolution: 0.1 $^\circ$

Accuracy: $\pm 0.2^\circ$

DC Offset

Range: DC only (no AC signal): 0 to ± 5.0 V/50 Ω .

DC + AC: Maximum DC offset ± 4.5 V on highest range, decreasing to ± 4.5 mV on lowest range.

Resolution: 4 digits

Sinewave Amplitude Modulation

Modulation depth at full output for each range: 0-100%

Modulation frequency range: DC to 500 kHz (0-21 MHz carrier frequency)

Sensitivity: ± 5 V peak for 100% modulation

Sinewave Phase Modulation

Range: $\pm 850^\circ$, ± 5 V input

Modulation frequency range: DC -5 kHz

Frequency Sweep

Sweep Time

Linear: 0.01 s to 99.99 s

Logarithmic: 2 s to 99.99 s single, 0.1 s to 99.99 s continuous

Maximum sweep width: Full frequency range of the main signal output for the waveform in use, except minimum log start frequency is 1 Hz.

Phase continuity: Sweep is phase continuous over the full frequency range of the main output.

Auxiliary Inputs and Outputs

Reference input: For phase-locking 3325A to an external frequency reference signal from 0 dBm to +20 dBm into 50 Ω . Reference signal must be a subharmonic of 10 MHz from 1 MHz to 10 MHz.

Auxiliary frequency output: 21 MHz to 60.999 999 999 MHz, under range coverage to 19.000 000 001 MHz, frequency selection from front panel. 0 dBm; output impedance: 50 Ω

Sync output: Square wave with V (high) ≥ 1.2 V, V (low) ≤ 0.2 V into 50 Ω .

X-Axis drive: 0 to $> +10$ V DC linear ramp proportional to sweep frequency, linearity, 10-90%, $\pm .1\%$ of final value.

Sweep marker output: High to low TTL compatible voltage transition at selected marker frequency.

Z-Axis blank output: TTL compatible voltage levels capable of sinking 200 mA from a positive source.

1 MHz reference output: 0 dBm output for phase-locking additional instruments to the 3325A.

10 MHz oven output: 0 dBm internal high stability frequency reference output for phase-locking 3325A. (Opt. 001 only)

Option 001 High Stability Frequency Reference

Ageing rate: $\pm 5 \times 10^{-8}$ /week, 1×10^{-7} /mo.

Ambient stability: $\pm 5 \times 10^{-8}$ (0° to $+55^\circ$ C).

Warm-up time: Reference will be within $\pm 1 \times 10^{-7}$ of final value 15 minutes after turn-on for an off time of less than 24 hours.

Option 002 High Voltage Output

Frequency range: 1 μ Hz to 1 MHz

Amplitude

Range: 4.00 mVpp to 40.00 Vpp (500 Ω , < 500 pf load).

Accuracy and flatness at full output:

Sine, square, and triangle waves: $\pm 2\%$ at 2 kHz

Ramps: $\pm 2\%$ at 500 Hz

Flatness: $\pm 10\%$ relative to programmed amplitude

Sinewave distortion: Harmonically related signals will be the same as the standard instrument to 1 MHz

Maximum output current: 80 mApp.

Output impedance: < 2 Ω at DC, < 10 Ω at 1 MHz

DC offset range: 4 times the specified range of the standard instrument.

General

Operating environment:

Temperature: 0° C to 55° C.

Relative humidity: 95%, 0° C to 40° C.

Altitude: $\leq 15,000$ ft.

Storage temperature: -40° C to $+75^\circ$ C.

Storage altitude: $\leq 50,000$ ft.

Power: 100/120/220/240 V, +5%, -10%, 48 to 66 Hz; 90 VA, 120 VA with all options; 10 VA standby.

Weight: 9 kg (20 lbs.) net; 14.5 kg (32 lbs.) shipping

Size: 132.6 H \times 425.5 W \times 497.8 mm D (5.25" \times 16.75" \times 19.63")

Accessories: 11356A Ground Isolator for breaking signal grounds between input/output connectors.

Ordering Information*

	Price
3325A Frequency Synthesizer	\$3600
Opt. 001 High Stability Frequency Reference	add \$600
Opt. 002 High Voltage Output	add \$225
Opt 907 Front Handle Kit (stand alone orders P/N 5061-0089)	\$32
Opt 908 Rack Flange Kit (stand alone orders P/N 5061-0077)	\$25
Opt 909 Rack Flange and Handle Combination Kit (stand alone orders P/N 5061-0083)	\$55
11356A Ground Isolator	\$60

*HP-IB cable not supplied. See page 30.

FUNCTION GENERATORS & FREQUENCY SYNTHESIZERS

.01 Hz to 13 MHz Frequency Synthesizer

Model 3320B

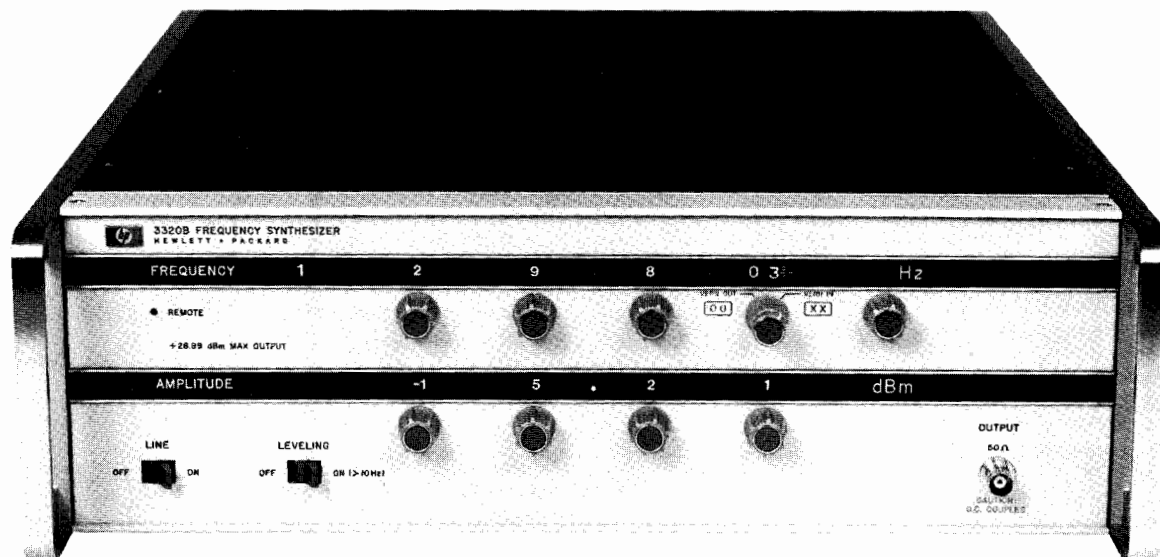

3320B

Specifications

Refer to the 3320B data sheet for complete specifications.

Frequency range: 0.01 Hz to 13 MHz in 7 ranges.

Frequency ranges: 10 MHz, 1000 kHz, 100 kHz, 10 kHz, 1000 Hz, 100 Hz and 10 Hz (optional). 30% overrange on all ranges.

Frequency resolution:

Range	Vernier Out (local or remote)	Vernier In (local)	Vernier In (remote)
10 MHz	10 kHz	10 Hz	1 kHz
1000 kHz	1 kHz	1 Hz	100 Hz
100 kHz	100 Hz	0.1 Hz	10 Hz
10 kHz	10 Hz	0.01 Hz	1 Hz
1000 Hz	1 Hz	1 mHz	0.1 Hz
100 Hz	0.1 Hz	0.1 mHz	0.01 Hz
10 Hz	0.01 Hz	0.01 mHz	0.001 Hz

Frequency Accuracy

Vernier out: $\pm 0.001\%$ of setting for 6 mo, 0°C to 55°C.

Vernier in: $\pm 0.01\%$ of range for 6 mo, 0°C to 55°C.

Frequency Stability

Long term: ± 10 parts in 10^6 of setting per year (vernier out) with ambient temperature reference. Optional high stability crystal reference oven available (Option 002).

Signal-to-phase noise (integrated): >40 dB down in 30 kHz band, excluding ± 1 Hz, centered on carrier. 10 MHz range, vernier out. Improves on lower frequency ranges.

Harmonic distortion: with output frequencies $>0.1\%$ of range at full output amplitude, any harmonically related signal will be less than the following levels: -60 dB with output from 5 Hz to 100 kHz; -50 dB with output from 100 kHz to 1 MHz; -40 dB with output from 1 MHz to 13 MHz.

Spurious: >60 dB down.

Internal frequency standard: 20 MHz crystal.

Phase locking: the 3320B may be phase locked with a 200 mV to 2 V rms signal that is any subharmonic of 20 MHz.

Rear panel output: front or rear panel output is standard.

Auxiliary Outputs

Tracking outputs: 20 MHz to 33 MHz offset signal. >100 mV rms/50Ω.

1 MHz reference output: 220 mV rms/50Ω (>0 dBm/50Ω).

Low level output: same frequency as main output but remains between 50 mV rms and 158 mV rms (into 50Ω) depending on main output level setting.

3320B Amplitude Section

Amplitude range: $+26.99$ dBm ($\frac{1}{2}$ watt) to -69.99 dBm (-73.00 dBm under remote control) into 50Ω. ($+26.99$ dBm = 5 V rms into 50Ω).

Amplitude resolution: 0.01 dB.

Frequency response (10 kHz reference):

	"LEVELING OFF"		"LEVELING ON"	
	dc	10 Hz	10 Hz	13 MHz
± 0.5 dB			± 0.05 dB	$+26.99$ dBm
			± 0.1 dB	-3.00 dBm
			± 0.2 dB	-23.00 dBm
			± 0.4 dB	-53.00 dBm
				-73.00 dBm

Amplitude accuracy (absolute): $+26.99$ dBm, ± 0.05 dB at 10 kHz and (20°C to 30°C).

Output impedance: 50Ω (75Ω Option 001).

General

Operating temperature: 0°C to 55°C.

Storage temperature: -40 °C to $+70$ °C.

Power requirements: 115 V or 230 V $\pm 10\%$, 48 Hz to 63 Hz, 110 VA max.

Weight

3320B: net, 15.9 kg (35 lb). Shipping, 19.5 kg (43 lb).

Size: 132.6 mm H, 425 mm W, 542.9 mm D ($5\frac{1}{32}$ " \times $16\frac{3}{4}$ " \times $21\frac{3}{8}$ ".)

Options and Accessories

Options and Accessories	Price
3320B Opt 001: 75Ω output	N/C
3320B Opt 002: Crystal Oven	\$540
3320B Opt 004: BCD remote control	\$460
3320B Opt 006: 100 Hz/10 Hz ranges	\$260
3320B Opt 007: HP-IB remote control	\$820
11048C: 50Ω feedthrough termination	\$25
11094B: 75Ω feedthrough termination	\$25
11473-74A: Balancing Transformers. (see page 711)	\$450
11475A: Balancing Transformers. (see page 711)	\$425

Ordering Information**

3320B Frequency Synthesizer \$5100

*Field installable.

**Except last vernier digit and line switch.

***HP-IB cable not supplied. See page 30.

FUNCTION GENERATORS & FREQUENCY SYNTHESIZERS

0.1 Hz to 13 MHz Automatic Synthesizer

Model 3330B

385



- Digital sweeping of frequency and amplitude

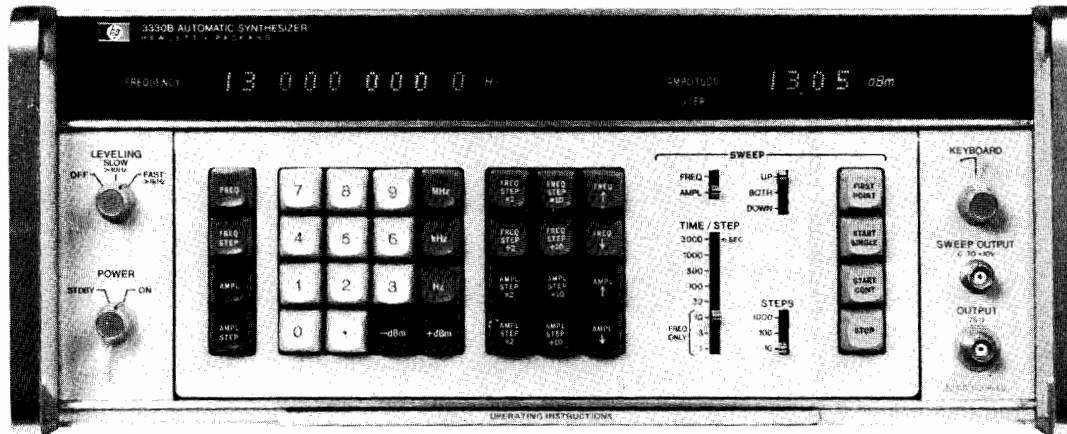

Abbreviated Specifications

(For complete specifications, refer to data sheet)

Frequency range: 0.1 Hz to 13,000,999.9 Hz.

Frequency resolution: 0.1 Hz (8 digits + overrange).

Frequency Stability

Long term: $\pm 1 \times 10^{-7}$ of frequency per day. $\pm 1 \times 10^{-7}$ of frequency per month.

Temperature: $\pm 1 \times 10^{-8}$ of frequency at $25^\circ\text{C} \pm 10^\circ\text{C}$. $\pm 1 \times 10^{-7}$ of frequency at 0°C to 55°C .

Signal to phase noise (integrated): 50 dB down in a 30 kHz band, excluding ± 1 Hz, centered on carrier.

Harmonic distortion: with full output amplitude, any harmonically related signal will be less than the following specified levels.

5 Hz to 100 kHz: -60 dB.

100 kHz to 1 MHz: -50 dB.

1 MHz to 13 MHz: -40 dB.

Spurious

All nonharmonically related spurious signals will be greater than 70 dB below selected output level or ≤ 110 dBm/50 Ω , whichever is greater.

Auxiliary Outputs

20 - 33 MHz tracking output: > 100 mV rms/50 Ω .

1 MHz reference output: > 220 mV rms/50 Ω (0 dBm/50 Ω).

Synthesized search or tune: a frequency step (0.1 Hz min) may be entered. This step may be added to or subtracted from the synthesized output signal. Rate of search or tune is selected by the time per step control.

Digital sweeping of frequency: accomplished by entering and setting the center frequency, a frequency step, number of steps, time per step, and sweep direction.

Sweep width: the product of the step size and number of steps.

Step size: continuously adjustable in 0.1 Hz increments.

Step accuracy: $\pm 1 \times 10^{-8}$ per day for standard reference crystal.

Number of steps: 10, 100, or 1000.

Time per step: 1 ms, 3 ms, 10 ms, 30 ms, 100 ms, 300 ms, 1000 ms, and 3000 ms.

Direction of sweep: up, both, down.

Single sweep: initiated by momentary pushbutton.

Continuous sweep: initiated by momentary pushbutton.

Manual sweep: accomplished by holding down the freq \uparrow or freq \downarrow keys. Display will follow output.

Sweep output: stepped dc voltage proportional to sweep position, 0 to +10V.

Accuracy: $\pm 0.2\%$ of full scale.

Linearity: $\pm 0.1\%$ of full scale.

Amplitude Section

Amplitude: maximum 2.1 V rms into open circuit; maximum 1.05 V rms into 50 Ω .

Amplitude range: +13.44 dBm to -86.55 dBm into 50 Ω .

Amplitude resolution: 0.01 dB.

Output impedance: 50 Ω (75 Ω Opt 001).

Display: four digit readout in dBm with reference to 50 Ω .

Leveled frequency response: (10 kHz reference) 10 Hz-13 MHz.*

+13.44 dBm to -16.55 dBm: ± 0.05 dB.

-16.55 dBm to -36.55 dBm: ± 0.1 dB.

-36.55 dBm to -66.55 dBm: ± 0.2 dB.

-66.55 dBm to -86.55 dBm: ± 0.4 dB.

Amplitude attenuator accuracy: ± 0.02 dB/10 dB step (at 10 kHz) of attenuation down from maximum output.

Amplitude accuracy (absolute): ± 0.05 dB at 10 kHz and +13.44 dBm ($25^\circ\text{C} \pm 5^\circ\text{C}$). (For absolute accuracy at other frequencies and amplitudes, add 0.05 dB to the leveled frequency response specification, plus the attenuator accuracy specification.)

Amplitude modulation: requires external modulation source. Rear panel BNC. ALC switch must be in slow position.

Modulating signal: 100 Hz to 100 kHz.

Modulation depth: 0.95 V rms modulating signal for 95% modulation depth.

General

Operating temperature: 0°C to $+55^\circ\text{C}$.

Storage temperature: -40°C to $+70^\circ\text{C}$.

Turn on time: application of power to "On": 20 min to within $\pm 1 \times 10^{-7}$ of the final frequency.

"Standby" to "On": 15 s to full specifications.

Power requirements: 115 V or 230 V $\pm 10\%$, 48 Hz to 63 Hz, 20 W standby, 200 W on.

Weight: net, 22.6 kg (53 lb). Shipping, 26.8 kg (63 lb).

Size: 177 mm H \times 426 mm W \times 547 mm D (7" \times 16.8" \times 21.5").

Options

001: 75 Ω -1 V output

002: High stability crystal oven

005: 5 V-50 Ω output

Price

N/C

add \$610

add \$310

3330B Automatic Synthesizer
(includes isolated HP-IB)

\$8900

FUNCTION GENERATORS & FREQUENCY SYNTHESIZERS

200 Hz to 80 MHz Automatic Synthesizer

Model 3335A

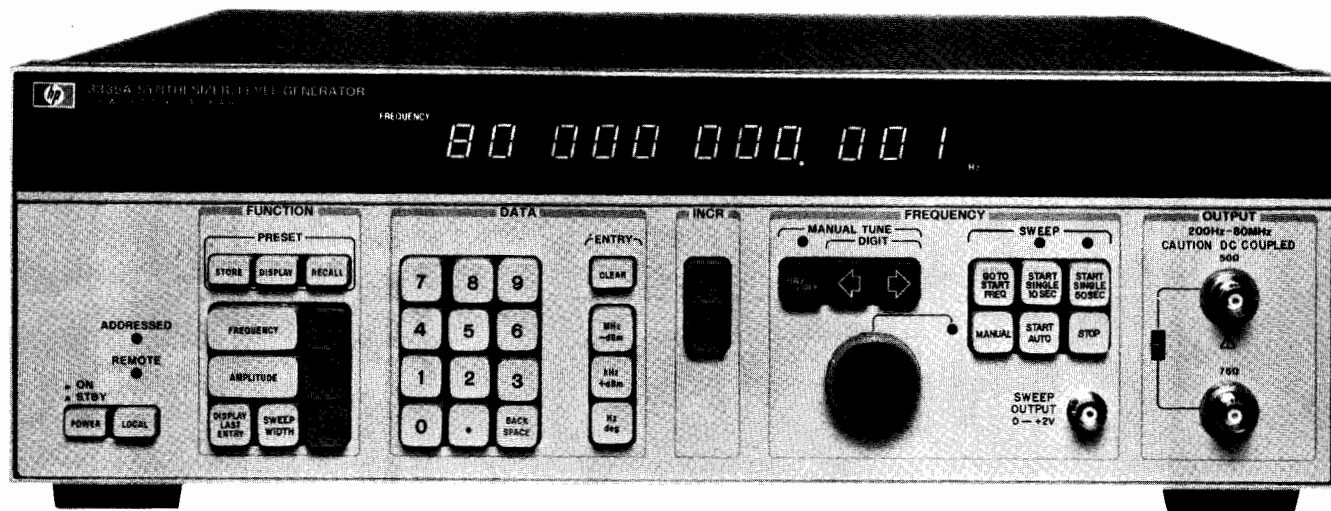

- 1 mHz Resolution
- High Spectral Purity
- Precision Amplitude Control
- Program Storage
- HP-IB



Description

Covering a frequency range of 200 Hz–80 MHz, the 3335A Synthesizer/Level Generator has performance characteristics that make it ideally suited for the telecommunications industry, as well as for traditional synthesizer applications, including testing of Frequency Division Multiplex (FDM) equipment and R & D and production testing of communications systems. It features precision level control, milli-Hertz resolution, high spectral purity, internal frequency sweep, HP-IB programmability and numerous user conveniences.

Internal Storage

Up to 10 different front panel settings (frequency, level, θ incr, etc.) can be stored in internal memory registers for later recall. The DISPLAY key allows viewing of register contents without altering the synthesizer output.

Precision Amplitude

Increasing channel capacity of Frequency Division Multiplex (FDM) systems is continually placing more stringent requirements on the testing of transmission parameters. To meet these performance standards, the 3335A incorporates a state-of-the-art attenuator resulting in attenuator accuracies of up to ± 0.025 dB over the 80 MHz frequency range.

Programmability

The 3335A is fully programmable via the Hewlett-Packard Interface Bus (HP-IB), HP's implementation of IEEE Standard 488–1975. Most Hewlett-Packard 9800 Series Programmable Calculators, as well as Models 21 MX and 2100 series minicomputers, are easily interfaced to the HP-IB.

Frequency Stability

The 3335A synthesizes its output frequency from an internal temperature-controlled crystal oscillator which provides $\pm 1 \times 10^{-8}$ /day frequency stability ($\pm 5 \times 10^{-10}$ is optional). The 3335A can also be phase-locked to any external frequency standards.

Automatic Frequency Sweep

The 3335A combines the precision frequency accuracy and stability of a synthesizer with the time-saving convenience of a digital sweeper.

SLMS - Tracking Generator

The 3335A operates as a tracking generator with the HP 3745A/B Selective Level Measuring Set (SLMS), or the 3586A/B/C Selective

Level Meter for automatic or semi-automatic testing of FDM systems. For closed-loop tracking where the 3335A and 3745A/B are in the same location, the frequency of the generator is controlled by the microprocessor in the SLMS.

Abbreviated Specifications

(complete specifications are shown on the 3335A data sheet.)

Frequency

Range: 200 Hz–80.999 999 999 MHz.

Resolution: 0.001 Hz.

Stability (higher stability available with Opt 001): $\pm 1 \times 10^{-8}$ /day; $\pm 1 \times 10^{-7}$ /month.

Frequency switching and settling time: <20 ms to within 90° of final phase.

Spectral Purity

Harmonic components (relative to fundamental, full output):

200 Hz – 10 MHz: –45 dB.

10 MHz – 80 MHz: –40 dB.

Spurious: all non-harmonically related outputs will be greater than 75 dB below the carrier or –125 dBm, whichever is greater.

Integrated phase noise (30 kHz band, excluding ± 1 Hz centered on the carrier): 9.9 MHz: –63 dB; 20 MHz: –70 dB; 40 MHz: –64 dB; 80 MHz: –58 dB.

Amplitude

Range

50 Ω : +13.01 dBm to –86.98 dBm; **75 Ω :** +11.25 dBm to –88.74 dBm.

Resolution: 0.01 dB.

Absolute accuracy (full amplitude at 100 kHz, 10°C to 35°C): ± 0.05 dB

Note: To determine absolute accuracy tolerances at other frequencies or amplitudes, the flatness and attenuator specifications must be added to the above accuracy specification.

Flatness (relative to 100 kHz, full amplitude): 1 kHz – 25 MHz: ± 0.07 dB; 200 Hz – 80 MHz: ± 0.15 dB.

Attenuator

Range: 98 dB in 2 dB steps.

Accuracy (1 year)

Z ₀	ATTENUATION (dB)	FREQUENCY		
		200 Hz	25 MHz	80 MHz
50 Ω	0 to 38	± 0.025 dB		
75 Ω		± 0.04 dB	± 0.15 dB	
50 Ω	40 to 58	± 0.03 dB		
75 Ω		± 0.09 dB	± 0.25 dB	
50 Ω	60 to 98	± 0.09 dB		
75 Ω		± 0.2 dB	± 0.50 dB	

Amplitude switching time: <500 ms to within ±0.02 dB of final value.

Sweep Characteristics

Sweep modes:

Single: 10 or 50s single sweep from min. to max. frequency.
Auto: repetitive sweep from min. to max. frequency at a nominal 125 ms rate.

Number of steps: 10 sec., 50 sec., MANUAL: 1000 steps; AUTO (125 ms): 100 steps.

Phase discontinuities: there will be no significant phase discontinuities provided the following breakpoints are not crossed:

200 Hz – <10 MHz: 1MHz points, e.g. 1 MHz, 2 MHz, etc.
 10 MHz – <20 MHz: 250 kHz points, e.g. 10.25 MHz, 10.5 MHz, etc.
 20 MHz – <40 MHz: 500 kHz points.
 40 MHz – 80 MHz: 1 MHz points.

Opt 001 (High Stability Frequency Reference)

Aging rate: ± 5 x 10⁻¹⁰/day; ± 2 x 10⁻⁸/month; ± 1 x 10⁻⁷/year.

Opt 002/004

For specifications not listed below, refer to standard instrument specifications, or the 3335A data sheets.

Frequency

Range: 75Ω: 200 Hz–80.999 999 999 MHz; 124Ω: 10 kHz–10 MHz; 135Ω: 10 kHz–2 MHz.
Resolution: .001 Hz.

Amplitude

Range: +11.25 dBm to –88.74 dBm.
Resolution: 0.01 dB.

Flatness (relative to 100 kHz at full amplitude):

75Ω: 1 kHz – 25 MHz: ±0.07 dB; 200 Hz – 80 MHz: ±0.15 dB
 124Ω: 50 kHz – 10 MHz: ±0.15 dB; 10 kHz – 10 MHz: ±0.40 dB
 135Ω: 10 kHz – 2 MHz: ±0.18 dB

Accuracy at full output (100 kHz, 10°C to 35°C): 75Ω: ±0.05 dB; 124Ω/135Ω: ±0.10 dB

Amplitude accuracy (includes the effects of flatness and attenuator)

75 Ω	200 Hz	1 kHz	25 MHz	80 MHz
+ 11.25				
- 8.74	± 0.25 dB	± 0.15 dB	± 0.35 dB	
-48.74	± 0.30 dB	± 0.20 dB	± 0.45 dB	
-88.74	± 0.40 dB	± 0.30 dB	± 0.70 dB	

124 Ω	10 kHz	50 kHz	10 MHz
+ 11.25			
- 8.74	± 0.60 dB	± 0.35 dB	
-48.74	± 0.65 dB	± 0.40 dB	
-70.0*	± 1.1 dB	± 0.85 dB	

135 Ω	10 kHz	2 MHz
+ 11.25		
- 8.74	± 0.35 dB	
-48.74	± 0.40 dB	
-70.0*	± 0.85 dB	

*Levels down to –88.74 dBm can be selected, however, accuracies are unspecified due to spurious noise floor of –100 dBm.

Outputs

Output impedances: 75Ω unbalanced, 124Ω balanced, 135Ω balanced
Signal balance (100 kHz): >60 dB.

Opt 002

75Ω: commercial equivalent of WECO type 477B (accepts WECO plug 358A).

124Ω: commercial equivalent of WECO type 477B at 16 mm (0.625") spacings (accepts WECO plug 372A)

135Ω: commercial equivalent of WECO type 223A at 16 mm (0.625") spacings (accepts WECO plug 241A).

Opt 004

75Ω: commercial equivalent of WECO type 560 A (accepts WECO plug 439A or 440A).

124Ω: commercial equivalent of WECO type 560A at 12.7 mm (0.5") spacings (accepts WECO plug 443A).

135Ω: commercial equivalent of WECO type 223A at 16 mm (0.625") spacings (accepts WECO plug 241A).

Opt 003

Frequency

Range: 75Ω: 200 Hz - 80.999 999 999 M Hz; 150Ω: 10 kHz - 2 MHz
Resolution: .001 Hz.

Amplitude

Range: + 11.25 to –88.74 dBm.
Resolution: 0.01 dB.

Flatness (relative to 100 kHz at full amplitude): 75Ω: 1 kHz–25 MHz: ±0.07 dB, 200 Hz–80 MHz: ±0.15 dB; 150Ω: 10 kHz–2 MHz: ±0.18 dB.

Accuracy at full output (100 kHz, 10°C to 35°C): 75Ω: ±0.05 dB; 150Ω: ±0.10 dB.

Amplitude accuracy (includes the effects of flatness and attenuator)

75 Ω	200 Hz	1 kHz	25 MHz	80 MHz
+ 11.25				
- 8.75	± 0.25 dB	± 0.15 dB	± 0.35 dB	
-48.74	± 0.30 dB	± 0.20 dB	± 0.45 dB	
-88.74	± 0.40 dB	± 0.30 dB	± 0.70 dB	

150 Ω	10 kHz	2 MHz
+ 11.25		
- 8.74	± 0.35 dB	
-48.74	± 0.40 dB	
-70.0*	± 0.85 dB	

*Levels down to –88.74 dBm can be selected, however accuracies are unspecified due to spurious noise floor of –100 dBm.

Outputs

Output impedances: 75Ω Unbalanced, 150Ω Balanced
Signal balance (100 kHz): >60 dB

Connectors

75Ω: BNC; 150Ω: Pair of BNC's at 20 mm (0.8") spacings

General

Operating Environment

Temperature: 0°C to 55°C.
R.H.: <95%, 0°C to +40°C.
Storage temperature: –40°C to +75°C.
Power: 100/120/220/240 V, +5%, –10%; 48 to 66 Hz; 195 VA.
Weight: net: 18.2 kg. (40 lbs). Shipping: 26.8 kg. (59 lb).
Size: 132.6 mm H x 425.5 mm W x 497.8 mm D (5¼" x 16¾" x 19½").

Ordering Information*

3335A Synthesizer/Level Generator	\$8500
Opt 001: High Stability Reference	add \$580
Opt 002: Connector Option	add \$350
Opt 003: Connector Option	add \$200
Opt 004: Connector Option	add \$350
Opt 907: Front Handle Kit	add \$32
Opt 908: Rack Mount Kit	add \$25

*HP-IB cable not supplied. See Page 30.

FUNCTION GENERATORS & FREQUENCY SYNTHESIZERS

Synthesizer/Level Generator

Model 3336 A/B/C

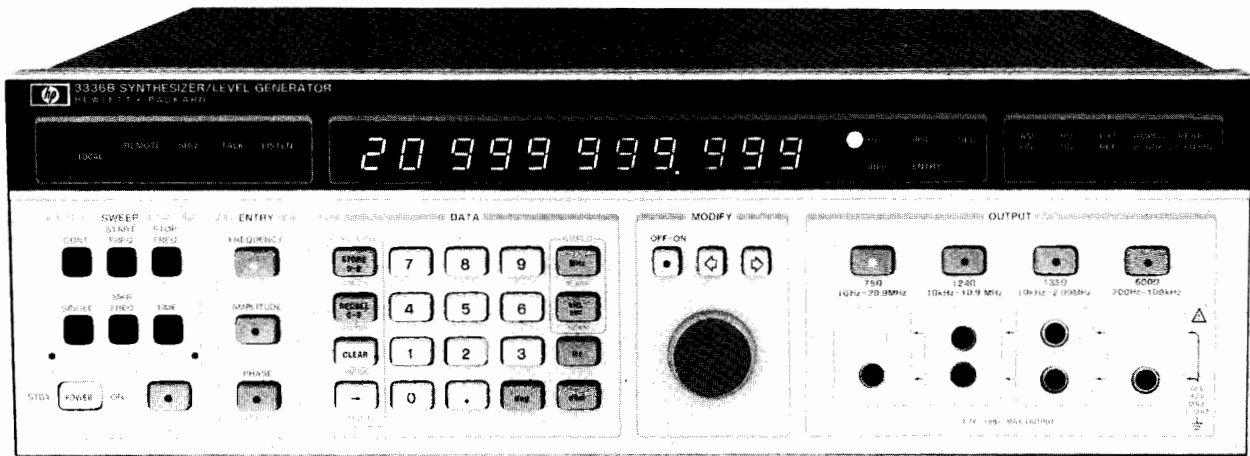

3336B

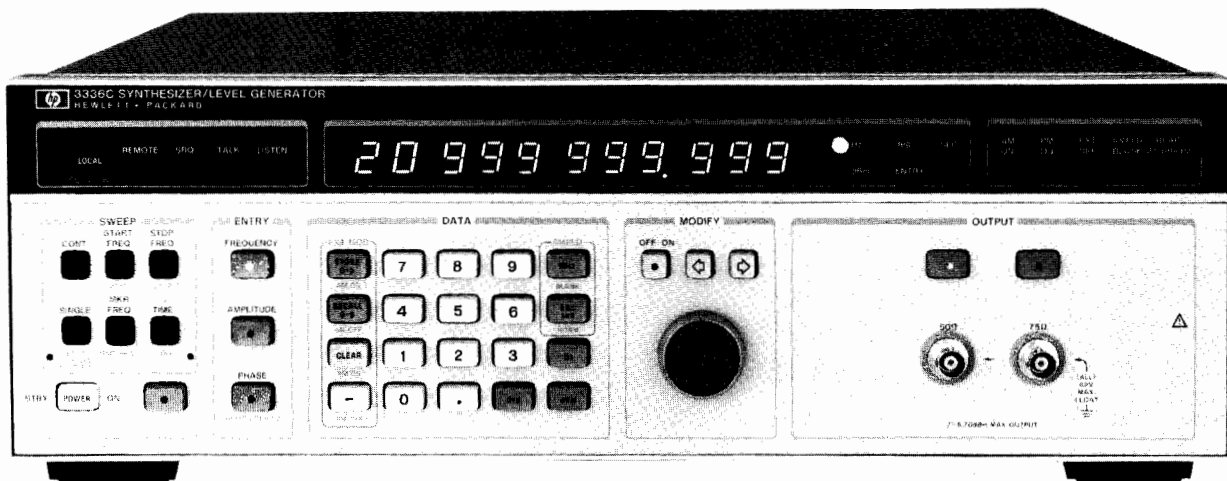

3336C



Description

Covering a frequency range of 10 Hz to 20.999 MHz, the 3336A (CCITT) and 3336B (Bell) Synthesizer/Level Generators have performance characteristics that make them ideally suited for the telecommunications industry. The 3336C is designed for traditional synthesizer applications as well as R&D and production testing of systems or components. All three feature precision level control, high spectral purity, optional frequency stability of $\pm 5 \times 10^{-8}$ /week, internal frequency sweep and numerous user conveniences. All models include HP-IB (IEEE Std. 488-1975) as a standard feature for use in automatic test systems.

Precision Frequency Measurements

Major advances in HP technology have provided a single loop, fractional-N synthesis technique which allows synthesizer accuracy with 11 digits of resolution, plus . . . completely phase continuous frequency sweep over any of the instrument's frequency ranges. Microhertz resolution below 100 kHz allows precise frequency measurements over a range of 10 Hz to 20.999 999 999 MHz. Harmonics are below 60 dB over the range from 50 Hz to 1 MHz (50 dB to 20 MHz), with spurious signals below 70 dBc or -100 dBm in the standard instrument, -115 dBm with an option.

± 0.05 dB Amplitude Accuracy

New HP attenuator technology coupled with custom designs in leveling loops and thermal converters produce amplitude accuracies seen only in instruments at much greater cost. The fast leveling loop makes extremely flat sweeps possible at fast sweep speeds. External leveling is also available for those custom applications where a control loop is desired.

HP-IB

The 3336A, B and C come standard with HP-IB. Remote programming of major front panel controls makes these instruments a versatile and powerful addition to automatic test systems. The isolated interface combined with floating inputs and outputs contributes to ease of use in systems applications.

Other Features

Both the 3336A & B have true balanced outputs which can be floated. All three models (the 3336A, B & C) have 10 storage registers; amplitude blanking capability during frequency switching; linear or logarithmic phase continuous sweep capabilities; RPG (rotary pulse generator) to simplify modification of any digit in the display; phase offset capability; output connector and impedance flexibility; AM and PM modulation, and many other features. Refer to the data sheet for complete information.



Abbreviated Specifications

Frequency

Signal Output	3336A	3336B	3336C
50 Ω Unbalanced			10 Hz to 20.999 999 999 MHz
75 Ω Unbalanced	10 Hz to 20.999 999 999 MHz		
124 Ω Balanced		10 kHz to 10.999 999 999 MHz	
135 Ω Balanced		10 kHz to 2.099 999 999 MHz	
150 Ω Balanced	10 kHz to 2.099 999 999 MHz		
600 Ω Balanced	200 Hz to 109.999 999 kHz		

Resolution: 1 μ Hz for frequencies < 100 kHz, 1 mHz for frequencies \geq 100 kHz

Accuracy: $\pm 5 \times 10^{-6}$ of programmed frequency (20° to 30°C)

Aging rate: $\pm 5 \times 10^{-6}$ /year (20° to 30°C)

Warm-up time: 30 minutes to within specified accuracy

Amplitude

Range: 50 Ω : -71.23 to +8.76 dBm; 75 Ω and 600 Ω : -72.99 to +7.00 dBm; 124 Ω , 135 Ω , 150 Ω : -78.23 to +1.76 dBm

Absolute accuracy: $\pm .05$ dB, 20° to 30°C (for the top 9.99 dB of amplitude range at 10 kHz, 50 kHz for 124 Ω , 135 Ω , 150 Ω); $\pm .08$ dB, 0° to 55°C

Flatness: 50/75 Ω , $\pm .1$ dB ($\pm .07$ dB with option 005) referenced to 10 kHz, 124, 135, 150 Ω , ($\leq \pm .15$ dB referenced to 50 kHz).

Attenuator accuracy: (Instruments without Option 005)

	10 Hz	1 MHz	10 MHz	20.9 MHz
10 to 19.99 dB	$\pm .1$ dB	$\pm .15$	$\pm .2$ dB	$\pm .2$ dB
20 to 39.99 dB	$\pm .15$ dB	$\pm .2$ dB	$\pm .25$ dB	$\pm .25$ dB
40 to 79.99 dB	$\pm .2$ dB	$\pm .25$ dB	$\pm .3$ dB	$\pm .3$ dB

Note: Amplitude Accuracy is the sum of the Absolute Accuracy and, as necessary, Flatness and Attenuator Accuracy. See page 592 (3336 A/B) for overall amplitude. Accuracy specification expressed versus output level.

Amplitude blanking: output drops to less than -85 dBm during frequency switching

Main Signal Outputs

Return loss (on carrier), balance

Output	Return Loss	Balance
50 Ω (3336C)	>30 dB, 10 Hz to 10 MHz, >25 dB, 10 MHz to 20 MHz	Unbalanced
75 (3336 A/B/C)	>30 dB, 10 Hz to 20 MHz	Unbalanced
124 Ω (3336B)	>20 dB, 10 kHz to 30 kHz >30 dB, 30 kHz to 10 MHz	>30 dB 10 kHz to 10 MHz
135 Ω (3336B)	>20 dB, 10 kHz to 30 kHz >30 dB, 30 kHz to 2 MHz	>36 dB 10 kHz to 2 MHz
150 Ω (3336A)	>20 dB, 10 kHz to 30 kHz >30 dB, 30 kHz to 2 MHz	>36 dB 10 kHz to 2 MHz
600 Ω (3336 A/B)	Not specified	>38 dB 300 Hz to 50 kHz

Spectral Purity:

Harmonic distortion: harmonically related signals will be less than the following levels relative to the fundamental (normal leveling):

Frequency Range*	Harmonic Level
50 Hz to 1 MHz	-60 dB
1 MHz to 5 MHz	-55 dB
5 MHz to 20 MHz	-50 dB

Integrated phase noise: (3336C) -64 dB, over a 30 kHz band, centered on a 20 MHz carrier, excluding 1 Hz about the carrier; (3336A & B) -72 dB for a 3 kHz band, 2 kHz either side of carrier.

Spurious: all non-harmonically related signals will be more than 70 dB below the fundamental or -100 dBm (-115 dBm with Option 005)

*Refer to data sheet for specifications below 50 Hz.

Phase Offset

Range: $\pm 719.9^\circ$ with respect to arbitrary reference phase.

Resolution: 0.1°

Accuracy: $\pm 0.2^\circ$

Frequency Sweep

Sweep time: linear; 0.01 s to 99.99 s. Single Log; 2 s to 99.99 s. Continuous Log; 0.1 s to 99.99 s.

Maximum sweep width: specified frequency range of selected output

Minimum sweep width: log; 1 decade. Linear; minimum BW (Hz) = .1 (Hz/s) x Sweep Time (s)

Phase continuity: phase is continuous over full frequency range.

Sweep flatness: fast leveling; $\pm .15$ dB, 10 kHz to 20 MHz, .03 s

Sweep time: normal leveling; $\pm .15$ dB, 50 Hz to 1 MHz, .5s sweep time.

Amplitude Modulation

Modulation depth: 0 to 100%

Modulation frequency range: 50 Hz to 50 kHz

Envelope distortion: < -30 db to 80% modulation (1 kHz modulating frequency)

Phase Modulation

Range: 0° to $\pm 850^\circ$

Linearity: $\pm 0.5\%$ from best fit straight line

Modulation frequency range: dc to 5 kHz

Input sensitivity: ± 5 V peak for 850° phase shift (170°/volt)

Auxiliary Outputs

AUX 0 dBm: frequency range is 21 MHz to 60.999 999 999 MHz

SYNC OUT: TTL square wave with $V_{high} > 1.2$ V into 50 ohms.

REF OUT: 0 dBm (50 Ω), 1 MHz signal for phase locking.

10 MHz OVEN OUT: Instruments with Opt 004 only. 0 dBm (50 Ω), 10 MHz temperature stabilized, crystal oscillator.

X DRIVE: 0 to $> +10$ Vdc linear ramp.

Z BLANK: sweep related TTL compatible voltage levels.

MARKER: TTL compatible high to low level transition at the programmed Marker Frequency.

Auxiliary Inputs

EXT REF IN: For phase-locking the Model 3336 to an external frequency reference. Signal from 0 dBm to +20 dBm (50 Ω).

AMPTD MOD: See Amplitude Modulation specifications.

PHASE MOD: See Phase Modulation specifications.

EXTERNAL LEVELING: Input from an External Leveling voltage source to regulate the signal amplitude at a remote point.

Option 004: High Stability Frequency Reference (all models)

Accuracy: $\pm 5 \times 10^{-8}$

Aging rate: $\pm 5 \times 10^{-8}$ /week after 72 hours continuous operation
 $\pm 1 \times 10^{-7}$ /month after 15 days continuous operation

Ambient stability: $\pm 5 \times 10^{-8}$ maximum, 0° to 55°C.

Option 005: High Accuracy Attenuator (Models 3336 A/B/C)

Accuracy: attenuation

10 to 19.99 dB	$\pm .035$ dB
20 to 29.99 dB	$\pm .06$ dB
40 to 79.99 dB	$\pm .1$ dB

General

Operating environment:

Temperature: 0° to 55°C

Relative humidity: $\leq 85\%$, 0° to 40°C

Altitude: 15,000 ft, ≤ 4600 meters

Storage temperatures: -50° to +65°C

Storage altitude: $\leq 50,000$ ft, 15,240 meters

Power requirements: 100/120/220/240 V, +5%, -10%, 48 to 66 Hz, 60 VA, (100 VA with all options), 10 VA standby

Size: 132.6 H x 425.5 W x 497.8 D or 5.2" x 16.8" x 19.6"

Weight: net, 10 kg. (22 lbs.); shipping, 15.5 kg. (34 lbs.)

Ordering Information*

	Price
3336A Synthesizer/Level Generator (CCITT)	\$4400
3336B Synthesizer/Level Generator (N. American)	\$4400
3336C Synthesizer/Level Generator (General Purpose)	\$4100
Opt 004 High Stability Frequency Reference	add \$550
Opt 005 High Accuracy Attenuator	add \$550
Opt 907 Front Handle Kit	add \$32
Opt 908 Rack Flange Kit	add \$25
Opt. 909 Rack Flange and Handle Kit	add \$55

*HP-IB cables not furnished. See page 30.

390 FUNCTION GENERATORS & FREQUENCY SYNTHESIZERS

1 Hz–20 MHz Pulse/Function Generator

Model 8111A

- Sine, triangle, square, haverfunctions
- 20 MHz, 32 Vpp for all waveforms
- Variable duty cycle or pulse width
- Trigger, gate, VCO and optional burst
- Digital display for all parameters
- Error recognition



8111A Option 001

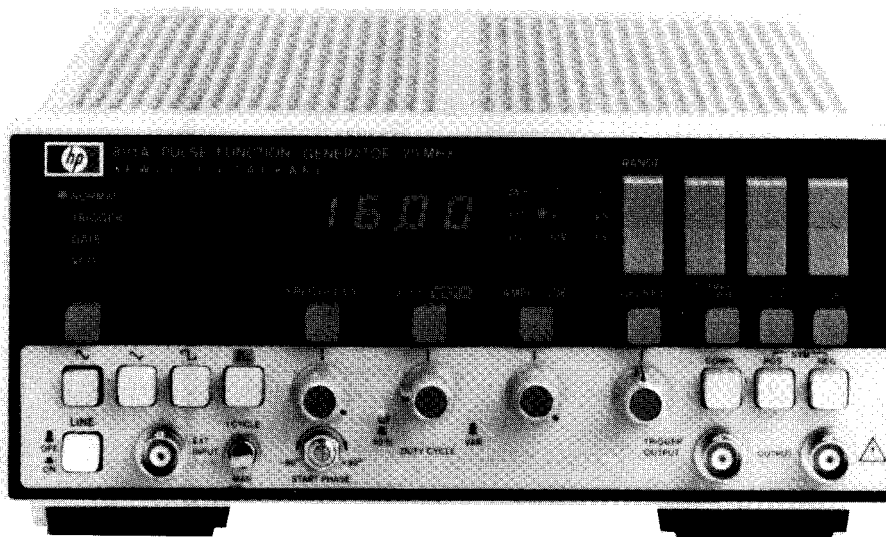

The 8111A combines pulse generator and function generator capabilities in a single, compact unit. Triggered operation for all waveforms, and the ability to define rectangular waveforms in terms of pulse width or duty cycle, are examples of the 8111A's versatility.

Saves Space and Equipment

Small size and manifold capability make the 8111A an ideal source for service and bench. Digital display, error detector and good repeatability assure high operating confidence. This reduces the need for output monitoring and consequently saves equipment.

Flexible

Operating modes include VCO which permits frequency-shift keying and dc-to-frequency conversion as well as sweep and FM applications. Option 001's Burst mode simplifies tone burst generation and digital preconditioning by generating a precise number of waveform cycles. An "extra cycle" feature activated after a burst allows critical events to be examined.

Pulse mode's variable width down to 25 ns and clean 10 ns transitions provide useful digital test capability. High analog flexibility is assured because all waveforms can be generated in trigger, gate and burst modes. Adjustable duty cycle up to 999 kHz means that CRT sawtooth waveforms and rectangular signals for dc motor control can be simulated.

Specifications (50-ohm load resistance)

Waveforms:

sine, triangle, ramp, square, pulse, haverfunctions.

Timing

Frequency

Range: 1.00 Hz to 20.0 MHz (3-digit resolution).

Accuracy (50% duty cycle): 5% ($\pm 10\%$ below 10 Hz).

Jitter: $< 0.1\% + 50$ ps.

Stability: $\pm 0.2\%$ (1 hour), $\pm 0.5\%$ (24 hours).

Duty Cycle (sine, triangle, square, haverfunctions):

	Calibrated	Variable (below 1 MHz)
Range:	50% nominal	10% to 90%.
Resolution:	2 digits	2 digits.
Accuracy:	± 1 digit	± 6 digits (± 3 in range 20 to 80%).

Pulse Width

Range: 25.0 ns to 100 ms (3-digit resolution).

Accuracy: $\pm 5\% \pm 2$ ns.

Output Characteristics

(voltages double into high impedance)

Amplitude

Range: 1.60 mVpp to 16.00 Vpp ($3\frac{1}{2}$ digit resolution).

Accuracy: $\pm 5\%$ (at 1 kHz for sine and triangle).

Flatness (sine, triangle): $\pm 3\%$ ($+10\%$, -15% above 1 MHz).

Offset

Range: 0.00 mV to ± 8.00 V (3-digit resolution).

Accuracy: $\pm 0.5\%$ setting $\pm 1\%$ ampl ± 20 mV

(ampl ≥ 160 mVpp),

$\pm 0.5\%$ setting $\pm 1\%$ ampl ± 1 mV

(ampl < 160 mVpp).

Distortion: THD $< 1\%$ (-40 dB) below 100 kHz, $< 3\%$ (-30 dB) above 100 kHz; may increase by 3dB at 0°C and 55°C .

Linearity (triangle): $< \pm 3\%$ ($< \pm 1\%$ below 1 MHz)

Pulse and Squarewave Performance

Transitions: < 10 ns.

Perturbations: $< \pm 5\%$ ($< \pm 10\%$ below 0.16 Vpp).

Output impedance: ± 50 ohm $\pm 5\%$.

Modes:

normal, trigger*, gate*, VCO and (Option 001) burst*.

*Adjustable start-phase for haversine, havertriangle

VCO range: 2 decades, ext. signal 0.1 V to 10 V (dc to 1 kHz).

Burst length: 1 to 1999 periods for all waveforms.

General

Repeatability: factor 2.5 better than accuracy.

Environmental

Storage temperature: -40°C to $+75^\circ\text{C}$.

Operating temperature: 0°C to 55°C .

Humidity: 95% RH, 0°C to 40°C .

Power: 100/120/220/240 V rms; $+5\% - 10\%$; 48 to 440 Hz; 70 VA max.

Weight: net, 4.6 kg (10 lb). Shipping, 6.6 kg (15 lb).

Size: 89 H x 212.3 W x 345 mm D (3.5 x 8.36 x 13.6 in).

Ordering Information

8111A Pulse/Function Generator

Opt 001: Burst

Opt 910: Extra Operating and Service Manual

5061-2001: Bail Handle Kit

5061-0072 Rack Mount Kit (single 8111A)

5061-0074 Rack Mount Kit (two instruments)

5061-0094 Lock Link Kit (for use with 5061-0074)

Price

\$1775

add \$375

add \$20

\$25

\$50

\$20

\$42

FUNCTION GENERATORS & FREQUENCY SYNTHESIZERS

1 MHz–50 MHz Pulse/Function Generator

Model 8116A

391



- Sine, triangle, square, haversine and dc
- 1 MHz–50 MHz, 32 Vpp for all waveforms
- Variable (10 ns min) pulse width, 6 ns transitions
- Wide range of operating capability
- Self-prompting operating concept
- Error recognition and self test

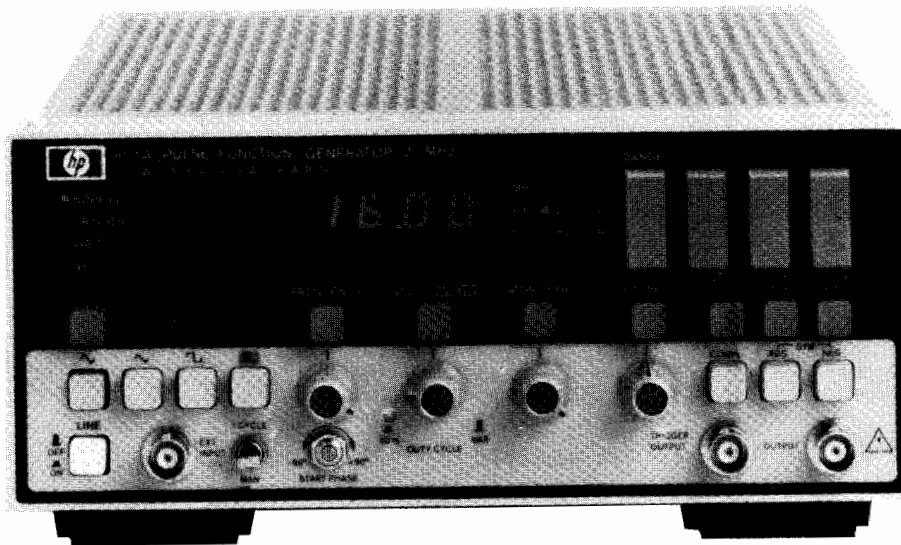

8116A
Option 001



The fully programmable 8116A features pulse as well as function generator capabilities in one small unit. A broad 1 MHz–50 MHz band for all waveforms and a wide choice of operating and modulating modes assure high flexibility. These factors, plus good repeatability, make the 8116A a sound, long-term investment.

Unique Operating Concept Saves Engineering Time

HP's custom IC's have made it feasible to put the many 8116A capabilities into such a small volume. Handling is simplified by a unique, microprocessor-controlled, operating concept which ensures a clear overview of the compact front panel at all times. When the mode and waveform have been selected, illuminated labels show which parameters must be set. There's no clutter, no confusion.

Auto vernier. In normal mode, the 8116A's auto-vernier increments any desired parameter continuously until a stop signal is applied. This means that thresholds can be measured automatically, without a controller.

Level or amplitude programming. The 8116A's output can be programmed in terms of high and low levels or in terms of amplitude and offset. Consequently a direct, automatic, conversion is always feasible so that the 8116A can be programmed in the same terms as the device is specified.

Safe limit. Devices can be protected by the limit feature. This prevents the output from exceeding a given magnitude.

Rectangular Waveforms

For applications such as laser diodes or dc motors, square waves can be programmed for constant duty cycles from 10% to 90%. For digital test, or for simulating very low duty-cycle events, pulse width can be programmed down to 10 ns. Square wave and Pulse modes provide clean 6 ns edges that are ideal for many technologies. Pulse width modulation and pulse recovery capability are available in Pulse mode.

Sine and Triangle Functions

10% to 90% duty cycle, programmable in 1% steps, provides ramps and asymmetrical sine waves for testing VCO's, servos, amplifier linearity and industrial process control systems. Haversine functions,

available in External Trigger, Gate and Burst modes, extend the applications to areas such as telephone line and vibration testing.

Modulation

All waveforms can be amplitude or frequency modulated. VCO operation allows frequency variation over two decades with an external voltage; consequently transducer output can be conditioned for mag tape recording, or frequency-shift keying or linear sweep can be carried out.

Option 001

10 1/2-decade log sweep. Sweep mode covers the wide 1 MHz–50 MHz band in a single up sweep. Test setups require no more than an X-Y recorder or scope because all necessary control signals are available. The 8116A sweeps can be internally triggered, if desired.

Accurate, counted bursts. A preprogrammed number of cycles of any waveform can be generated in Burst mode. With sine, triangle and square functions, bursts can be triggered internally as well as externally.

Hold capability. For material stress testing, low frequency functions can be held at instantaneous levels. Hold is controlled by an external signal.

Low-Cost Automation for Bench and Systems

Powerful capability, small size and wide specified temperature range make the 8116A a good choice for automatic test systems. Also, the low cost means that it's now realistic to automate those routine bench jobs and leave more time for design. Comfortable software features such as easy syntax and flexible format contribute to rapid system design.

Operating Confidence

There's reliance in the 8116A's output because proper operation is always ensured by the instrument's error detector. This helps the user to recover from an incorrect front panel or programming operation by indicating the offending parameter. Also, the built-in test and diagnosis feature verifies correct function each time the instrument is switched on.

Specifications: see page 354.



FUNCTION GENERATORS & FREQUENCY SYNTHESIZERS

50 MHz Programmable Signal Source

Model 8165A

- Pulse/function capability
- Sine, triangle, square to 50 MHz
- Pulses and ramps to 20 MHz
- Trigger, gate and counted burst
- Synthesizer stability, precision amplitude
- Storage of operating parameters

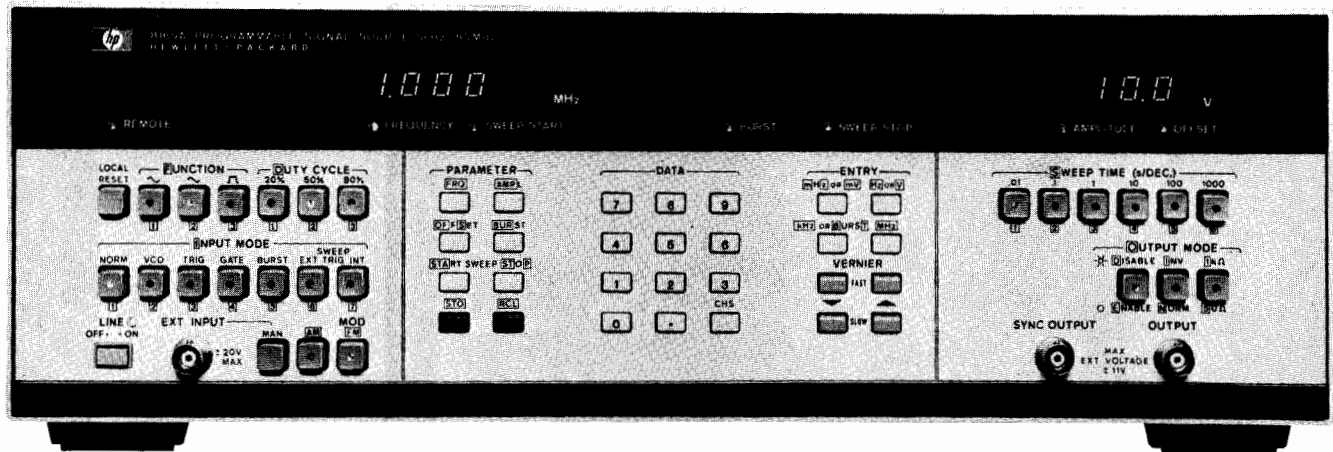

8165A Option 002

Versatility and Simplicity for Systems and Bench

The 8165A Programmable Signal Source is a versatile function generator with good accuracy and many trigger features. Micro-processor control assures rapid, accurate setup whether programming locally or via HP-IB.

Operating Set Storage

Ten complete sets of operating information can be stored and recalled. In the event of power failure, battery back up retains all data plus the active settings.

Stability and Resolution

Very stable frequency is ensured with phase lock loop techniques and internal crystal reference. The four-digit frequency display means a 1 μ Hz resolution in the 1 to 9.999 MHz range.

Specifications

Waveforms and Frequency Range

Sine, Square, Triangle (50% duty cycle): 1.000 MHz to 50.00 MHz.

Pulse/Ramp (20, 80% symmetry): 1.000 MHz to 19.99 MHz.

Haversine/havertriangle: please inquire for special option.

Output Characteristics

Range: amplitude and offset independently variable within ± 10 V window.

Source impedance: selectable 50 Ω \pm 1% or 1 k Ω \pm 10%

Amplitude: 10.0 mVpp to 10.0 Vpp (50 Ω into 50 Ω)
2.00 Vpp to 20.0 Vpp (1k Ω into 50 Ω)

Accuracy: (sine, square) \pm 2%, \pm 5% above 5 MHz

Offset: 0 \pm 10 mV to \pm 5.00 V (50 Ω into 50 Ω)
0 \pm 20 mV to \pm 10.0 V (1k Ω into 50 Ω)

Accuracy: \pm 1% programmed value \pm 1% signal Vpp \pm 20 mV.

Sine characteristics

Distortion: total harmonic distortion (THD) for fundamental up to 1 MHz: \pm 1%.

Harmonic signals: (fundamental 1-10 MHz): \leq -36 dB

Harmonic signals: (fundamental above 10 MHz): \leq -30 dB.

Non-harmonic: \leq -40 dB.

Square/pulse characteristics

Transition times: (10% to 90%): \leq 5 ns (50 Ω into 50 Ω), \leq 7 ns (1 k Ω into 50 Ω)

Preshoot/Overshoot/ringing: \leq \pm 5% (50 Ω into 50 Ω), \pm 10% (1k Ω into 50 Ω).

Triangle/ramp characteristics

Linearity: (10% to 90%): \leq \pm 1% (\leq \pm 5% above 5 MHz).

Operating Modes

Norm (continuous phase locked), **VCO** (external sweep voltage),

Trig (ext or man. one-shot), **Gate**, **Burst** (1-9999 counted cycles),

Frequency modulation.

HP-IB: control and learn capability for all modes and parameters.

General

Memory: non volatile. 10 addressable locations plus one for active operating state. Each location can store a complete set of operating parameters and modes.

Power: 100/120/220/240 Vrms; \pm 5%, -10%; 48 to 66 Hz, 200 V A max.

Operating Temperature: 0 $^{\circ}$ to 50 $^{\circ}$ C

Weight: net 12 kg (26.5 lbs). Shipping 16 kg (35.3 lbs).

Size: 133 H \times 426 W \times 422 mm D (5.2" \times 16.8" \times 16.6").

Ordering Information

8165A Programmable Signal Source*

Opt 002: Sweep + AM

Opt 003: Rear Panel Connectors

Opt 907: Front Handle Kit (Part No 5061-0089)

Opt 908: Rack Mounting Kit (Part No 5061-0077)

Opt 909: Opt 907, 908 combined (Part No 5061-0083)

Opt 910: additional Operating and Service Manual

*HP-IB cables not supplied, see page 30.

Price

\$6810

add \$880

N/C

add \$32

add \$25

add \$55

add \$70



SIGNAL GENERATORS

Signal Generators to 40 GHz



Hewlett-Packard offers a complete line of easy to use HF, VHF, UHF, and SHF signal generators covering a frequency range from 10 kHz to 40 GHz. This line includes synthesized signal generators and solid-state mechanically tuned generators as well as performance-proven vacuum tube signal generators. Each includes the following features: 1) accurately calibrated variable frequency, 2) accurately calibrated variable output level, and 3) wide modulation capability.

HP signal generators ensure the utmost convenience and accuracy for a wide variety of measurements, including receiver tests such as sensitivity and selectivity. Signal generators are also used for signal simulation measurements such as signal-to-noise ratio, gain bandwidth, conversion loss, and antenna gain. They also provide power to drive mixers, bridges, slotted lines, etc.

Solid State, Mechanically Tuned Generators

Solid-state mechanically tuned generators combine fundamental oscillators with solid-state circuitry to yield excellent spectral purity for modern performance requirements. The 8640 and 8680 series also feature outstanding frequency stability and modulation performance. For economy applications, the 8654 is a low-cost solution.

2.3 to 12.5 GHz Solid-State Generators

The 8680 series solid-state microwave signal generators are high performance generators designed to meet the stringent requirements of modern microwave radar and communications testing. With the 8683A, 8683B covering from 2.3 to 6.5 GHz, and 8684A, 8684B spanning 5.4 to 12.5 GHz, these generators feature state-of-the-art cavity-tuned oscillators to provide excellent frequency stability and spectral purity.

Also providing high performance AM, FM, and pulse modulation, microprocessor enhancements, and ease of serviceability, the 8680 series signal generators represent a new level of performance in mechanically-tuned generators.

Both the 8683 and the 8684 are available in the "A" version, optimized for communications testing, and the "B" version, offering higher maximum leveled output power and high performance internal pulse modulation for radar testing. The B models feature an internal pulse generator and an internal pulse modulator yielding a > 80 dB on/off ratio, and rise/fall times < 10 ns, with pulsed power leveled to within 0.5 dB of the level set in CW mode.

The 8683A and 8684A offer the same outstanding spectral purity and performance as the B models, but with only limited external pulse modulation to yield outstanding value for communications testing. Both the A and B models have low distortion AM and FM, and feature an internal variable sawtooth for FM swept measurements. Both models also feature outstanding ± 2 dB output level accuracy and 1% frequency accuracy.

0.5 to 1024 MHz, High Performance

The high performance leaders of the RF solid-state, mechanically tuned family are the 8640A and 8640B signal generators, covering 450 kHz to 550 MHz. Frequency coverage can be extended to 1024 MHz with an internal doubler (Option 002), and an optional built-in audio oscillator extends the CW range down to 20 Hz (Option 001). The 8640 provides wide output level range and high power output from +19 to -145 dBm. Featuring high performance AM and FM with low phase noise at typical receiver channel spacings, the 8640 is an ideal generator for a wide variety of receiver measurements.

The 8640B with built-in counter has the ability to count external signals at frequencies up to 550 MHz and to phase-lock the

generator's RF output to the counter time base for frequency stability of better than 5×10^{-8} /hour. The 8640A utilizes a mechanical slide rule frequency dial.

For avionics navigation and communications applications, the 8640B Option 004 can be combined with suitable external modulation sources for testing ILS, VOR, and VHF communications receivers.

10 to 520 MHz, Compact, Field Portable

Compact, portable signal generators form another part of the solid-state, mechanically tuned family. The 8654A and 8654B cover from 10 to 520 MHz, providing output power from +10 to -130 dBm. Small size and light weight make them well suited for field maintenance and operational readiness checks in addition to general purpose signal generator applications. The 8654B has fully calibrated and metered AM and FM, whereas the 8654A is an AM generator with uncalibrated FM capability.

Synthesized Signal Generators

Synthesized signal generators combine the frequency stability, resolution and programmability of a high quality synthesizer with the calibrated variable output and modulation of a signal generator. Collectively covering a frequency range from 10 kHz to 18 GHz, these highly versatile programmable signal generators find application in a wide variety of automated systems and high performance applications.

0.1 to 990 MHz Low Cost Synthesized Signal Generator

The 8656A, an economical programmable RF signal generator, provides synthesized signals from 0.1 to 990 MHz. The 8656A offers a wide range of standard features, including 100 and 250 Hz resolution, full keyboard control, reverse power protection to 50W, and HP-1B programmability.



Featuring AM and FM and simultaneous modulation with external modulating signals or internal 400 Hz and 1 kHz tones, the 8656A is ideal for in-channel receiver testing. Receiver channels are easily selected with the frequency increment feature. And because HP-IB is standard, the 8656A is a cost-effective programmable solution for these in-channel measurements, as well as being an ideal general-purpose RF source for other automatic system applications.

The 8656A also features excellent output level accuracy of ± 1.5 dB and precise output level resolution of 0.1 dB for increased measurement accuracy and settability. Low RFI leakage allows the 8656A to be used for low-level testing of RFI-susceptible devices.

10 kHz to 1280 MHz Low Noise Synthesized Signal Generator

The HP 8662A covers 10 kHz to 1280 MHz with calibrated output level from +13 to -140 dBm. A high performance AM/FM signal generator, the 8662A achieves extremely low phase noise and spurious signals while maintaining fast frequency switching. The low phase noise close to the carrier (-112 dBc/Hz at a 100 Hz offset) optimizes the 8662A for the most critical low noise applications (e.g., local oscillator). The low phase noise at typical channel spacings (-132 dBc/Hz at a 10 kHz offset) allows both in-channel and out-of-channel receiver measurements to be made under programmable control.

The 8662A utilizes an internal micro-processor to provide ease of operation, including keyboard control and incrementing

capability of all functions. Totally HP-IB programmable, the 8662A also features a powerful precision digital sweep.

10 kHz to 2600 MHz Synthesized Signal Generator

The HP 8660A/C is a particularly versatile synthesized signal generator family, offering two mainframes and a variety of RF and modulation plug-ins. The 8660A mainframe utilizes thumbwheel switches for frequency selection. The 8660C has a more versatile keyboard control featuring synthesized digital sweep and frequency-step capability. Both HP-IB and BCD programming interfaces are available.

Three plug-in RF sections provide separate frequency ranges: 10 kHz to 110 MHz, 1 MHz to 1300 MHz, and 1 MHz to 2600 MHz. Output levels are calibrated over >140 dB range. Five different modulation plug-ins provide versatile combinations of AM, FM, Φ M and pulse modulation.

2 to 18 GHz Microwave Synthesized Signal Generator

The HP 8672A is an AM/FM Signal Generator providing synthesized signals from 2 to 18 GHz. Calibrated output level from +3 to -120 dBm is standard, with Option 008 providing high power output to +8 dBm.

A companion unit for use in local oscillator applications, the 8671A is a synthesizer only, with a minimum output of +8 dBm from 2 to 6.2 GHz and internal FM capability only. Both units are programmable via the HP Interface Bus.

Typical 8672A applications include use as a programmable signal simulator in automatic test systems, for satellite receiver test-

ing requiring highly stable signals, general purpose lab use, and production use.

Performance-proven Vacuum Tube Signal Generators

Hewlett-Packard's microwave vacuum tube signal generators provide coverage from 800 MHz to 21 GHz. The 618C, 620B, 626A, and 628A incorporate cavity-tuned klystron oscillators with low drift and residual FM. Pulse, square-wave and frequency modulation capabilities make them useful for microwave receiver testing as well as SWR and transmission line measurements.

The 8614A and 8616A Signal Generators, covering 0.8 to 2.4 GHz and 1.8 to 4.5 GHz, feature built-in PIN diode modulators. These modulators allow internal or external output power leveling as well as high performance pulse and amplitude modulation.

HP 938A and 940A Frequency Doubler Sets provide low-cost signal generator capability in the 18 to 40 GHz range by doubling the frequency of signal sources in the 9 to 20 GHz range.

Signal Generator Accessories

A variety of accessories are available to enhance the operation of HP signal generators. These include frequency doublers, a fuse holder, balanced mixers, filters, a series of PIN modulators, a pulse modulator and a down converter. The 11720A Pulse Modulator provides high performance pulse modulation capability over the range of 2 to 18 GHz. The 11710B Down Converter extends the frequency range of the 8640 and 8654 down to 10 kHz.

Signal Generator Summary

Frequency Range	Model	Characteristics	Page
0.5 to 512 MHz	8640B Opt. 004 Avionics Generator	Same as 8640B with AM phase shift $< \pm 0.01^\circ$ at 30 Hz, demodulated AM output, 1 dB sweep attenuator. For use with external VOR/ILS audio generators.	407
10 to 520 MHz	8654A, 8654B Signal Generators	Calibrated and leveled output from +10 to -130 dBm. Amplitude and frequency modulation. Compact, portable (17.5 lb).	408
0.5 to 1024 MHz	8640A, 8640B Signal Generators	Calibrated and leveled output from +19 to -145 dBm. AM, FM, and ext. pulse modulation. 8640B has built-in counter and phase lock capability.	404
0.1 to 990 MHz	8656A Synthesized Generator	± 1.5 dB absolute level accuracy from +13 dBm to -127 dBm in 0.1 dB steps. Calibrated AM and FM. Frequency resolution of 100 Hz or 250 Hz. Time base aging rate of ± 2 ppm/year.	396
0.01 to 1280 MHz	8662A Synthesized Generator	Low noise. 0.1 Hz frequency resolution, 5×10^{-10} /day stability. Calibrated and leveled output from +13 to -140 dBm. Digital sweep. Completely HP-IB programmable. AM/FM modulation.	398
0.01 to 110 MHz 1 to 1300 MHz 1 to 2600 MHz	8660A, 8660C Synthesized Generators	1 Hz frequency resolution, 3×10^{-10} /day stability. Calibrated and leveled output from +13 to -146 dBm. HP-IB and BCD programmable. AM, FM, Φ M, pulse modulation. Plug-ins determine frequency range and modulation capability.	400
0.8 to 2.4 GHz 1.8 to 4.5 GHz	8614A, 8616A Signal Generators	Output +10 (8616; +3 dBm above 3 GHz) to -127 dBm into 50 ohms, leveled below 0 dBm. Internal square-wave; external pulse, AM and FM. Auxiliary RF output.	409
2 to 6.2 GHz	8671A Synthesizer	1 kHz frequency resolution, 5×10^{-10} /day stability, +8 dBm minimum output. Completely HP-IB programmable. Ext. FM.	415
3.8 to 7.6 GHz 7 to 11 GHz	618C, 620B Signal Generators	Output +0 to -127 dBm into 50 ohms. Int. pulse, frequency or square-wave modulation; ext. FM or pulse modulation. Auxiliary RF output.	410
2.3 to 6.5 GHz 5.4 to 12.5 GHz	8683B, 8684B Signal Generators	High spectral purity, stability. ± 2 dB absolute level accuracy from +10 to -110 dBm. AM, FM, and high performance int. pulse modulator, int. pulse generator. Portable, rugged (19.1 kg).	412
2.3 to 6.5 GHz 5.4 to 12.5 GHz	8683A, 8684A Signal Generators	Same as B models except with only limited ext. pulse modulation, +0 dBm standard output power.	412
2 to 18 GHz	8672A Synthesized Generator	1 to 3 kHz frequency resolution, 5×10^{-10} /day stability. Calibrated and leveled output from +3 to -120 dBm. Completely HP-IB programmable. Metered external AM and FM.	416
10 to 15.5 GHz 15 to 21 GHz	626A, 628A Signal Generators	Output +10 to -90 dBm; int. pulse, frequency or square-wave modulation; ext. FM or pulse modulation.	411
18 to 26.5 GHz 26.5 to 40 GHz	938A, 940A Frequency Doublers	Driven by 9 to 13.25 GHz. 13.25 to 20 GHz sources (HP 626A, 628A, 8690, 8672A, 8350A, and 8620 series sweepers or klystrons). 100 dB precision attenuator.	411

SIGNAL GENERATORS

Synthesized Signal Generator

Model 8656A

- 100 kHz to 990 MHz
- ± 1.5 dB absolute output level accuracy
- 0.1 dB output level resolution
- Versatile modulation
- Increments and Store/Recall/Sequence
- Fully HP-IB programmable

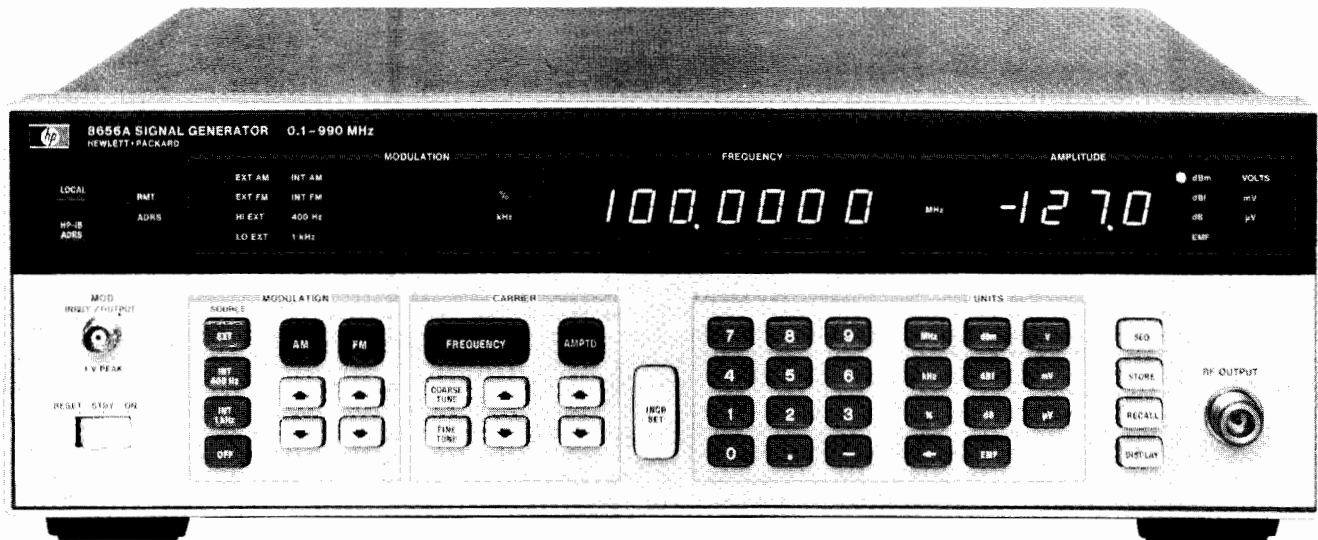

8656A



Description

The 8656A is a programmable synthesized signal generator that offers exceptional value through versatility, ease of operation, and a broad range of standard features.

Frequency

The 8656A provides frequency coverage from 0.1 to 990 MHz (with underrange to 10 kHz). This wide range covers the IF and LO frequencies as well as the RF frequencies of most receivers. It also allows testing in a variety of communication systems including the 800 MHz FM mobile band and some telemetry bands. Frequency resolution of 100 Hz or 250 Hz allows convenient setting of increments including 6.25 kHz channel spacings. Frequency accuracy and stability are determined by the reference used. The standard internal reference has an aging rate of 2 ppm/year. Improved stability and accuracy can be achieved by adding the optional 1×10^{-9} /day high stability time base (Option 001) or using an external reference of 1, 5, or 10 MHz.

Output

The 8656A features ± 1.5 dB absolute accuracy and 0.1 dB resolution for more accurate receiver sensitivity tests, circuit characterization, and R&D applications. The output levels are calibrated from +13 to -127 dBm and may be set and displayed in convenient units including dBm, volts, $\text{dB}\mu\text{V}$, or EMF. Shielding keeps leakage at $< 1\mu\text{V}$ for testing RFI susceptible devices, and standard resettable reverse power protection for up to 50 watts guards against accidental damage from transmitters.

Modulation

The 8656A has versatile modulation capabilities: internal 400 Hz and 1 kHz tones, simultaneous and mixed modulation modes (AM-AM, FM-FM, AM-FM) from internal and external sources, and the ability to accept low frequency digital unsquelching signals. For calibrated external modulation, a 1V peak signal is required. HI/LO annunciators on the 8656A indicate when the external signal is within 5% of the correct amplitude.

Ease of Operation

A microprocessor-based controller provides a broad range of operating features for simple but efficient control. Keyboard data entry uses a function/data/units format, and all function entries are made using a left-to-right keystroke sequence. All information entered is visible via LED displays and annunciators. Modulation, frequency, and level functions can be individually incremented by step sizes that are set by convenient keyboard entries. In addition, resolution control keys allow coarse and fine tuning of output frequency in decade steps.

Up to ten front-panel setups can be stored and recalled. A sequence function allows you to cycle through stored setups at the touch of a key or via remote control.

HP-IB Programmability

Full HP-IB programmability is standard in the 8656A. Each programming command has an easy-to-remember, two-character, alphanumeric HP-IB code, and all functions are quickly programmed using the same format as in the manual mode.



8656A Specifications

Frequency

Range: 100 kHz to 990 MHz (8 digit LED display).

Resolution: 100 and 250 Hz.

Accuracy and stability: same as internal time base.

Time base characteristics:

Typical Characteristics	Standard Time Base	Option 001 Time Base
Aging Rate	± 2 ppm/year	1 x 10 ⁻³ /day
Frequency	50 MHz	10 MHz
External Reference Input (rear panel)	Accepts any 10, 5 or 1 MHz (±0.002%) frequency standard at a level >0.15 Vrms into 50 ohms.	
Frequency Underrange	10 kHz with uncalibrated output	

Typical frequency switching speed (to be within 100 Hz of final frequency): < 2 seconds.

Spectral Purity

Spurious signals (≤ +7 dBm output levels)

Harmonics: < -25 dBc.

Non-harmonic spurious (greater than 5 kHz from carrier in CW mode): < -60 dBc.

Sub-harmonic spurious: none.

Residual FM:

Post Detection Noise Bandwidth	Frequency Range (MHz)			
	0.1 to 123.5	123.5 to 247	247 to 494	494 to 990
0.3 to 3 kHz	<15 Hz rms	<3 Hz rms	<6 Hz rms	<15 Hz rms
0.05 to 15 kHz	<30 Hz rms	<8 Hz rms	<16 Hz rms	<30 Hz rms

Residual AM (0.05 to 15 kHz post detection noise bandwidth): < -70 dBc.

Typical SSB phase noise (CW only):

Offset from Carrier	0.1 to 123.5 MHz (dBc/Hz)	123.5 to 247 MHz (dBc/Hz)	247 to 494 MHz (dBc/Hz)	494 to 990 MHz (dBc/Hz)
20 kHz	<-115	<-127	<-121	<-115
500 kHz	<-125	<-135	<-131	<-125

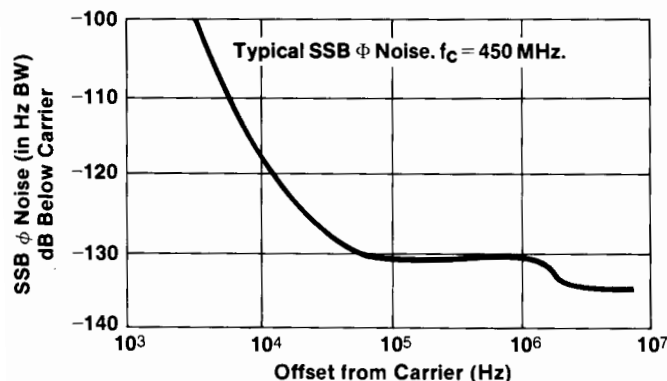

Output

Level range (into 50 ohms): +13 dBm to -127 dBm (3½ digit LED display).

Resolution: 0.1 dB.

Absolute level accuracy: ≤ 1.5 dB.

Level flatness (100 kHz to 990 MHz): ≤ ± 1.0 dB at an output level setting of 0.0 dBm.

Reverse power protection: protects signal generator from application of up to 50 watts (typical) of RF power to 990 MHz into generator output; dc voltage cannot exceed 25V.

Modulation

Amplitude modulation (2 digit LED display)

AM depth¹: 0 to 99% to +7 dBm and 0 to 30% to +10 dBm.

Resolution: 1%.

AM rate: internal 400 Hz and 1 kHz, ± 3%; external (1 dB bandwidth), 25 Hz to 25 kHz.

AM distortion (at internal rates): < 1.5%, 0-30% AM; < 3%, 31-70% AM; < 5%, 71-90% AM.

Indicator accuracy (for depths < 90% and internal rates)¹: (± 4% of reading) ± 2%.

Incidental phase modulation (at 30% AM depth and internal rates): < 0.3 radian peak.

Frequency modulation (2 digit LED display)

FM peak deviation:

Center Frequency (f_c)	Maximum Peak Deviation (Δf_{pk})*	
	Rates ≥ 60 Hz	Rates < 60 Hz
0.1-123.5 MHz	99 kHz	1600 x Rate
123.5-247 MHz	25 kHz	400 x Rate
247-494 MHz	50 kHz	800 x Rate
494-990 MHz	99 kHz	1600 x Rate

*FM not specified for $f_c - \Delta f_{pk} < 100$ kHz.

Resolution: 100 Hz for deviations less than 10 kHz; 1 kHz for deviations greater than 10 kHz.

FM rate: internal 400 Hz and 1 kHz, ± 3%; external (1 dB bandwidth, ac coupled), 25 Hz to 25 kHz.

FM distortion (for 100 Hz to 99 kHz peak deviations and internal rates): < 0.5% THD.

Indicator accuracy¹: ± 5% of reading at internal rates. (Add ± 5% if 250 Hz frequency increments are used).

Incidental AM (for center frequency ≥ 500 kHz, peak deviation > 20 kHz and internal rates): < 0.1%.

Digital FM: will accept typical digital unquenching signals. Sag of resultant demodulated signal is typically less than 8% at 1 kHz deviation for a 10 Hz square-wave modulating signal.

Remote Programming

Interface: HP-IB (Hewlett-Packard's implementation of IEEE Standard 488).

Interface functions implemented: SH1, AH1, T0, L2, SRO, RL1, PP0, DC1, DT0, and C0.

General

Operating temperature range: 0 to +55°C.

Leakage: conducted and radiated interference is within the requirements of methods CE03 and RE02 of MIL STD 461A, VDE 0871, and CISPR Publication 11. Furthermore, RF leakage of less than 1.0 μV is induced in a two-turn loop, 2.5 cm in diameter, held 2.5 cm away from the front surface.

Power requirements: 100, 120, 220, or 240V, (+5, -10%); 48 to 66 Hz; 125 VA maximum.

Weight: net, 18.1 kg (40 lb); shipping, 24.5 kg (54 lb).

Size: 133 H x 425 W x 520 D mm (5.25" x 16.75" x 20.5"). 5.25" x 1Mw x 17", system II module. For cabinet accessories, see pages 714-719.

Rack slides and transit case: HP part numbers are: slide kit, 1494-0018; tilt slide kit, 1494-0025; full module transit case, 9211-2661.

Ordering Information

8656A Signal Generator²

Option 001: High stability time base

Option 002: Rear panel input and output

Option 907: Front handle kit

Option 908: Rack flange kit

Option 909: Rack flange and front handle kit

Option 910: Extra operating & service manual

Price

\$6,750

add \$850

add \$175

add \$32

add \$25

add \$55

add \$30

¹AM depth and FM deviation are further limited by Indicator Accuracy specifications.

²HP-IB cables not supplied, see page 30 for description and prices.

SIGNAL GENERATORS

Synthesized Signal Generator

Model 8662A

- 10 kHz to 1280 MHz frequency range
- 0.1 Hz frequency resolution
- <420 μ s frequency switching speed
- SSB phase noise < -144 dBc/Hz at 10 kHz offset
- ± 1 dB level accuracy
- Fully HP-IB programmable



8662A



8662A Synthesized Signal Generator

The 8662A is a high performance synthesized signal generator covering the wide frequency range of 10 kHz to 1280 MHz in a single instrument while providing a wide range of accurately calibrated output power as well as full AM/FM capability.

Precision Synthesized Signal Generator

The 8662A derives exceptional RF performance from an indirect frequency synthesis technique that results in frequency resolution of 0.1 Hz (0.2 Hz above 640 MHz). Its frequency accuracy and stability are determined by a low noise quartz reference oscillator which has an aging rate of less than 5×10^{-10} /day.

The 8662A output level ranges from +13 dBm (+16 dBm in over-range) to -139.9 dBm with 0.1 dB resolution in both manual and remote (HP-IB) operation. From +13 to -120 dBm the absolute level accuracy is held to ± 1 dB using microprocessor correction. These exceptional output level characteristics make the 8662A an ideal generator for performing precise receiver sensitivity tests either manually or in automated systems.

The 8662A offers versatile phase-locked AM/FM using either internal 400 Hz and 1 kHz rates or externally applied modulating signals, which can be either dc or ac coupled. Several different modes of simultaneous modulation (such as AM + FM or FM + FM) are possible using internal and external modulation as well as a rear panel auxiliary FM input.

Exceptional Spectral Purity

The key contribution of the 8662A is spectral purity. Fast-tuning, switched-inductance oscillators combined with a low noise reference oscillator result in very low SSB phase noise, especially at small offsets from the carrier. The phase noise at 20 to 50 kHz offsets is comparable to that of the best cavity-tuned fundamental oscillators. Such excellent noise performance combined with programmability makes possible complete automation of receiver adjacent channel selectivity measurements.

With its excellent long and short-term frequency stability, high output power, fine frequency resolution, and broad frequency range the 8662A also meets the requirements of the most critical low noise local oscillator applications. In addition, its fast frequency switching and sweep capabilities also permit its use in many frequency agile and swept local oscillator applications.

Measurement Efficiency

An advanced microprocessor-based controller allows convenient keyboard control of all 8662A functions. For example, all functions can be incremented and decremented in any user-defined step size within the resolution of the synthesizer using the "increment" keys and the "knob". Up to nine full front panel setups can be stored in the 8662A's memory and recalled for later use in any user-defined sequence at the touch of a pushbutton. This permits time-saving semi-automation of generator operation in production setups where the generator must perform many different tests.

The microprocessor controller also allows convenient HP-IB programmability of all generator functions with the same resolution as manual operation. Each front panel button is represented by a two-character alphanumeric HP-IB programming code. The sequence of HP-IB commands used in remote operation is identical to the sequence of keystrokes used in manual operation. In addition, two special programming "learn" modes allow the HP-IB controller to store 8662A front panel settings or decrease the 8662A frequency switching time to under 420 microseconds. Partial remote 8662A operation without an HP-IB controller is possible using a rear panel auxiliary control connector.

Precision Digital Sweep

Fast frequency switching combined with microprocessor control gives the 8662A a powerful sweep capability. Automatic, single, and manual modes are available for both linear and logarithmic sweeps with user-selectable step size and number of steps. Five different sweep speeds can be chosen and up to five amplitude or Z-axis markers can be set for calibrating swept frequency displays. All sweep parameters can be controlled with full synthesizer resolution.

With this kind of sweep capability, the 8662A is ideal for the characterization of extremely narrow-band devices such as crystal filters. By storing two different sweep setups in the 8662A memory and using its "auto-sequence" capability, both wide-band and narrow-band swept characteristics of a device under test can be viewed simultaneously on an oscilloscope or network analyzer.



8662A Specifications

Frequency

Range: 10 kHz to 1280 MHz (1279.999998 MHz).

Resolution: 0.1 Hz (0.2 Hz above 640 MHz).

Accuracy and stability: same as reference oscillator.

Internal reference oscillator: 10 MHz quartz oscillator. Aging rate $< 5 \times 10^{-10}$ /day after 10 day warm-up (typically 24 hrs in normal operating environment).

Spectral Purity

Residual SSB phase noise in 1 Hz BW ($320 \leq f_c < 640$ MHz):

Offset from carrier				
10 Hz	100 Hz	1 kHz	10 kHz	100 kHz
-100 dBc	-112 dBc	-121 dBc	-131 dBc	-132 dBc

SSB broadband noise floor in 1 Hz BW at 3 MHz offset from carrier: < -146 dBc for f_c between 120 and 640 MHz at output levels above +10 dBm.

Spurious signals:

	Frequency range (MHz)				
	0.01 to 120	120 to 160	160 to 320	320 to 640	640 to 1280
Spurious non-harmonically related ^{1,2}	-90 dBc	-100 dBc	-96 dBc	-90 dBc	-84 dBc
Sub-harmonically related ($\frac{f}{2}, \frac{3f}{2}, \dots$)	none	none	none	none	-75 dBc
Power line (60Hz) related or microphonically generated (within 300 Hz) ³ .	-90 dBc	-85 dBc	-80 dBc	-75 dBc	-70 dBc
Harmonics	< -30 dBc				

Output

Level range: +13 to -139.9 dBm (1 V to 0.023 μ V_{rms} into 50 Ω).

Resolution: 0.1 dB.

Absolute level accuracy (+15° to +45°C): ± 1 dB between +13 and -120 dBm, ± 3 dB between -120 and -130 dBm.

SWR: Typically from 1.5 to 1.8 depending on output level and frequency.

Reverse Power Protection: Typically up to 30W or ± 8 Vdc.

Amplitude Modulation

Depth: 0 to 95% at output levels of +8 dBm and below (+10 dBm in uncorrected mode). AM available above these output levels but not specified.

Resolution: 1%, 10 to 95% AM; 0.1%, 0 to 9.9% AM.

Incidental PM (at 30% AM): 0.15-640 MHz, < 0.12 radian peak; 640-1280 MHz, < 0.09 radian peak.

Incidental FM (at 30% AM): 0.15-640 MHz, $< 0.12 \times f_{mod}$; 640-1280 MHz, $< 0.09 \times f_{mod}$.

Indicated accuracy: $\pm 5\%$ of reading $\pm 1\%$ AM. Applies for rates given in table below, internal or external mode, for depths $\leq 90\%$.

Rates and distortion with internal or external modulating signal:

Frequency range	AM rate	AM Distortion		
		0-30% AM	30-70% AM	70-90% AM
0.15-1 MHz	dc-1.5 kHz	2%	4%	5.75%
1-10 MHz	dc-5 kHz	2%	4%	5.75%
10-1280 MHz	dc-10 kHz	2%	4%	5.75%

Frequency Modulation

FM rates (1 dB bandwidth): external ac, 20 Hz to 100 kHz; external dc, dc to 100 kHz.

FM deviation: from 25 to 200 kHz depending on carrier frequency. **Indicated FM accuracy:** $\pm 8\%$ of reading plus 10 Hz (50 Hz to 20 kHz).

FM resolution: 100 Hz for deviations < 10 kHz, 1 kHz for deviations ≥ 10 kHz.

Incidental AM (AM sidebands at 1 kHz rate and 20 kHz deviation): < -72 dBc, $f_c < 640$ MHz; < -65 dBc, $f_c \geq 640$ MHz.

FM distortion: $< 1.7\%$ for rates < 20 kHz, $< 1\%$ for rates < 1 kHz.

Center frequency accuracy and long term stability in AC mode: same as CW mode.

Remote Programming

Interface: HP-IB (Hewlett-Packard's implementation of IEEE Standard 488).

Functions controlled: all functions controlled from the front panel with the exception of the line switch are programmable with the same accuracy and resolution as in manual mode.

General

Operating temperature range: 0° to +55°C.

Leakage: meets radiated and conducted limits of MIL STD 461A methods RE02 and CE03 as well as VDE 0871. Furthermore, less than 1 μ V is induced in a two-turn, 1-inch diameter loop 1 inch away from the front panel and measured into a 50 ohm receiver.

Power requirements: 115 (90-126) V or 230 (198-252) V; 48 to 66 Hz; 420 VA max.

Weight: net 30 kg (65.5 lb); shipping 36 kg (80 lb).

Size: 178 mm H x 425 mm W x 572 mm D (7" x 16.75" x 22.5"); depth includes front panel depth of 45 mm (1.75").

Supplemental Characteristics

Typical SSB Phase Noise:

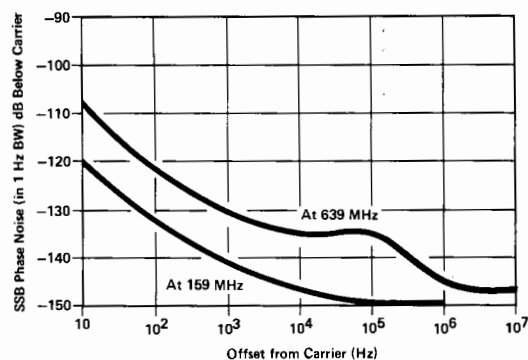

Frequency switching speed:⁴ From 420 μ sec to 12.5 msec, depending on the programming mode.

Ordering Information

8662A Synthesized Signal Generator

(Note: HP-IB cables not supplied; see page 30)

Option 001: Rear-panel RF output add \$175

Option 907: Front handle kit add \$40

Option 908: Rack flange kit add \$30

Option 909: Rack flange & front handle kit add \$65

Option 910: Extra operating & service manual add \$35

11721A External frequency doubler for operation to \$285

2.56 GHz

11714A Service Support Kit (required for service) \$500

¹In the remote mode it is possible to have microprocessor clock related spurious signals spaced 3 MHz apart at an absolute level of typically less than -145 dBm.

²Spurious signals can be up to 3 dB higher in the dc FM mode.

³At a 50 Hz line frequency, power line or microphonically related spurious signals may be up to 3 dB higher and appear at offsets as high as 1 kHz from the carrier.

⁴Due to automatic leveling loop bandwidth changes, brief (30 msec) level inaccuracies may occur when switching through 150 kHz and 1 MHz RF output frequencies.

SIGNAL GENERATORS

Synthesized Signal Generators

Models 8660A and 8660C

- 10 kHz to 2600 MHz
- Synthesizer stability and accuracy
- 1 Hz resolution (2 Hz above 1300 MHz)
- Calibrated output over > 140 dB range
- AM, FM, Φ M, or pulse modulation
- Fully BCD or HP-IB programmable

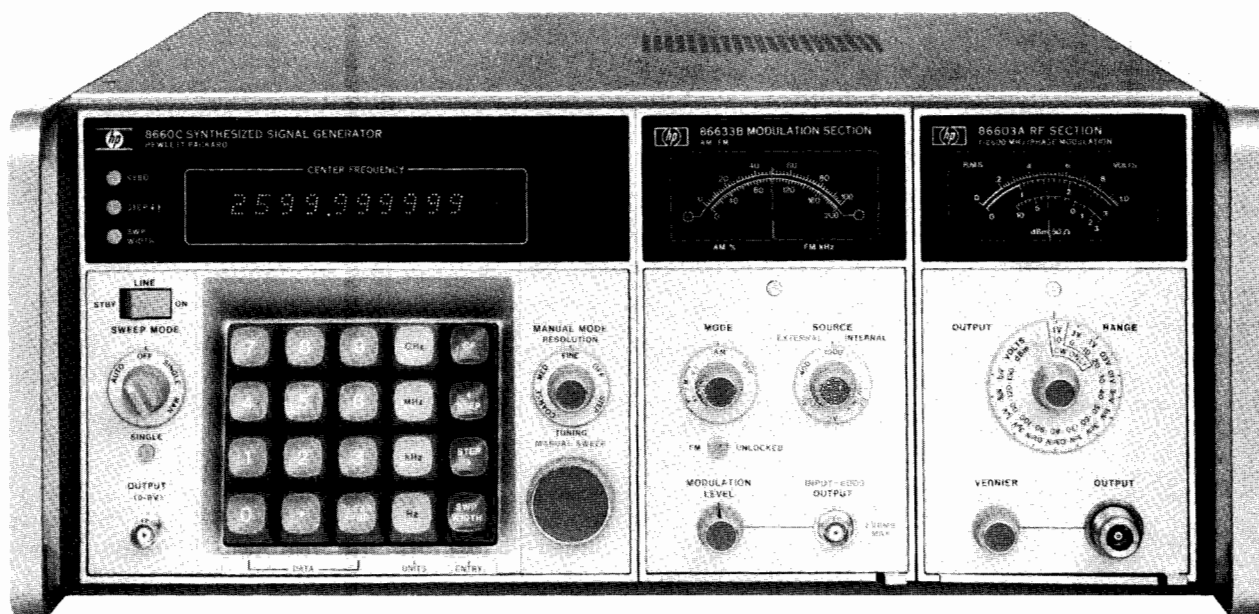

8660C



8660A, 8660C Synthesized Signal Generators

System Concept

The 8660A/C family is a modular solid-state plug-in system. Each system includes: 1) a programmable synthesized signal generator mainframe, 2) at least one RF section plug-in, and 3) at least one modulation section. This modular plug-in construction allows an 8660 system to be configured for any specific application while minimizing the added expense of unnecessary features.

As its name implies, the 8660 is a true frequency synthesizer. Yet it is finding even broader appeal as a high performance signal generator. And being completely programmable, the 8660 is an excellent choice for most automated receiver or component testing situations.

Mainframes

There are two different synthesized signal generator mainframes to choose from. Both feature complete TTL programming of frequency, output levels, and most modulation functions. The standard programming interface is BCD and an optional HP-IB interface is available. Both mainframes can operate from an internal crystal reference or external frequency standard.

The 8660A mainframe uses thumbwheel switches to select CW output frequencies. Frequencies up to 1300 MHz can be entered directly with 1 Hz resolution. For applications requiring frequencies above 1300 MHz the 8660A must be used with the 86603A Option 003. The frequency selection process involves selecting one-half of the desired RF output frequency and activating the 86603A Option 003 front panel doubler switch.

The 8660C keyboard mainframe provides direct keyboard entry of CW frequencies up to 2600 MHz. Added capabilities of the 8660C include digital sweep, frequency stepping, synthesized search, and a ten-digit numerical display.

Swept testing of very narrowband devices such as crystal filters is made possible by the 8660C's digital sweep. Since the RF output consists of discrete synthesized steps, the result is a very linear sweep with extremely low residual FM. A 0–8 V horizontal sweep output is provided for driving XY plotters, oscilloscopes, etc.

For applications which require frequency to be changed in uniform increments, a frequency stepping capability is provided on the 8660C. For example, if a receiver with 50 kHz channel spacing is being test-

ed, a 50 kHz step size can be entered and the frequency stepped to the next higher or lower channel with a single keystroke.

Synthesized search provides the dial tuning convenience of a signal generator while maintaining synthesizer signal quality. As the dial is turned the output frequency is tuned up or down in discrete synthesized steps which may be chosen as small as 1 Hz.

Plug-In RF Sections

There are three RF sections to choose from. The 86601A covers the 10 kHz to 110 MHz frequency range with calibrated output of +13 to -146 dBm. The 86602B covers 1 MHz to 1300 MHz with output of +10 to -146 dBm, and the 86603A covers 1 MHz to 2600 MHz with output of +7 to -136 dBm. Both the 86602B and the 86603A must be used with an 11661B Frequency Extension Module. The 11661B is installed internal to an 8660 mainframe, and therefore is not visible from the front panel. All RF sections have 1 Hz frequency resolution (2 Hz above 1300 MHz with the 86603A). In the remote mode, output level can be programmed in 1 dB steps over the full operating range.

Plug-In Modulation Sections

There are five modulation sections to choose from. The 86632B and 86633B are both AM/FM modulation sections. An accurate modulation meter indicates % AM or FM peak deviation. The 86633B differs from the 86632B in that the carrier is phase-locked for FM rates and deviations from 20 Hz to 100 kHz. The 86632B utilizes a free-running VCO during FM but allows rates and deviations from dc to 1 MHz. Any drift can be removed by depressing the FM CF CAL button.

The 86634A offers phase modulation at rates to 10 MHz and metered deviations to 100° below 1300 MHz and 200° above 1300 MHz. The 86635A Φ M/FM Modulation Section is similar in performance to the 86634A except rates are limited to 1 MHz and FM capability is also included. (The 86634A and 86635A must be used with Option 002 RF sections.)

The 86631B Auxiliary Section provides both external AM and pulse modulation. The 86631B Auxiliary Section must be used when another modulation section is not installed.

All modulation functions of the 86632B, 86633B, and 86635A are fully programmable.

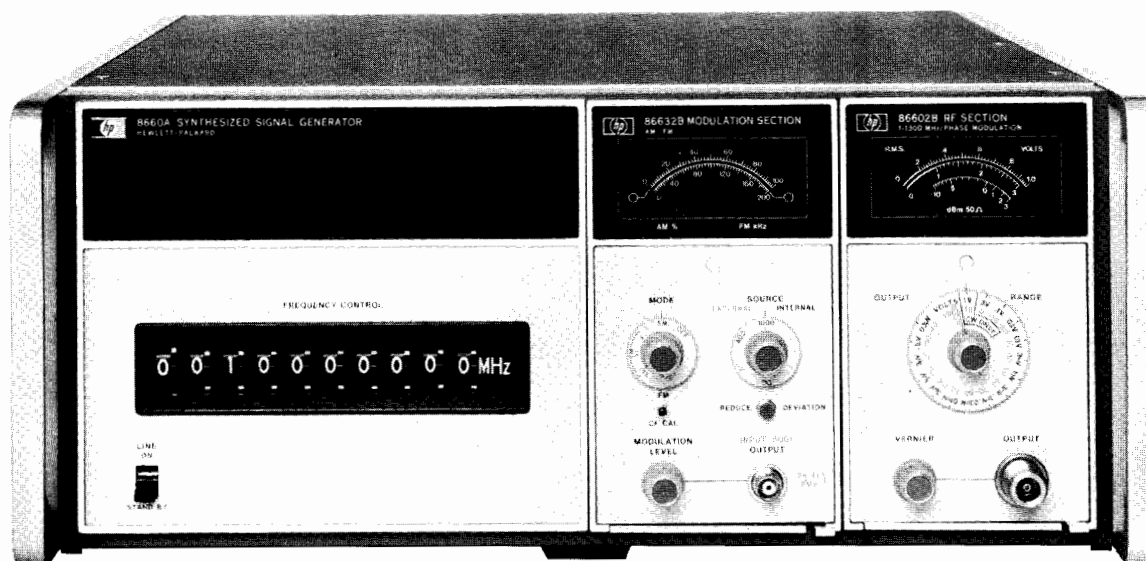

8660A



8660A, 8660C Mainframe Specifications

Frequency accuracy and stability: CW frequency accuracy and long term stability are determined by internal reference oscillator (3×10^{-8} /day), or by external reference.

Reference Oscillator

Internal: 10 MHz quartz oscillator. Aging rate less than ± 3 parts in 10^6 per 24 hours after 72 hours warm-up (± 3 parts in 10^9 per 24 hours, Option 001).

External: rear panel switch allows operation from 5 MHz or 10 MHz frequency standard at a level between 0.5 V and 2.5 Vrms into 170 ohms.

Reference output: rear panel BNC connector provides output of reference signal selected at level of at least 0.5 Vrms into 170 ohms.

Digital sweep (8660C): auto, single, or manual. Selectable speeds 0.1, 1, or 50 seconds.

Remote Programming

Functions

8660A: all front panel frequency and output level (and most modulation functions) are programmable.

8660C: CW frequency, frequency stepping (STEP \uparrow , STEP \downarrow), output level, and most modulation functions are programmable. Note: digital sweep is NOT programmable.

Programming Input

Connector type: 36-pin Cinch type 57 (mating connector supplied). 24-pin Cinch type 57 for optional HP-IB interface (mating connector NOT supplied).

Logic: TTL compatible (negative true).

Switching time: less than 5 ms to be within 100 Hz of any new frequency selected. (Less than 100 ms to be within 10 Hz.)

General

Operating temperature range: 0 to $+55^\circ\text{C}$.

Power: 100, 120, 220, or 240 volts $\pm 5\%$, -10% , 48-66 Hz; approximately 350 watts.

Weight (mainframe only): net, 23.2 kg (51 lb); shipping, 28.6 kg (63 lb).

Supplemental Characteristics

Typical single sideband phase noise

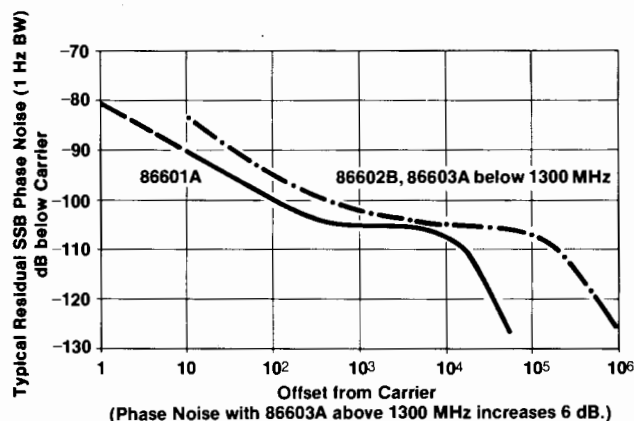

RF Section Specifications (Installed in 8660A or 8660C mainframe)

FREQUENCY CHARACTERISTICS	86601A	86602B (requires 11661B)	86603A (requires 11661B)	
	0.01—110 MHz (109.999999 MHz)	1—1300 MHz (1299.999999 MHz)	CF < 1300 MHz	CF \geq 1300 MHz
Frequency Range			1—2600 MHz (2599.999998 MHz)	
Frequency Resolution	1 Hz	1 Hz		2 Hz
Harmonics	< -40 dBc	< -30 dBc (< -25 dBc above +3 dBm)		< -20 dBc ¹
Spurious Non Harmonically Related	-80 dBc	-80 dBc below 700 MHz -80 dBc above 700 MHz within 45 MHz of carrier -70 dBc above 700 MHz > 45 MHz from carrier -50 dBc on +10 dBm range		-74 dBc within 40 MHz of carrier ¹ -64 dBc > 45 MHz from carrier < -64 dBc
Power Line Related (CW, AM, ϕ M only) ²	-70 dBc	< -70 dBc		
Signal To Phase Noise Ratio (CW, AM, ϕ M only) ²	> 50 dB	> 45 dB		> 39 dB

¹For output levels +3 dBm and below; slightly higher +3 to +7 dBm.

²Measured in a 30 kHz band centered on the carrier excluding a 1 Hz band centered on the carrier.



10 kHz to 110 MHz

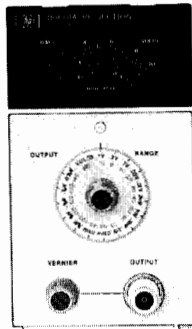

86601A

1 MHz to 1300 MHz

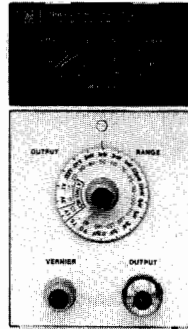
86602B
(11661B required)

1 MHz to 2600 MHz

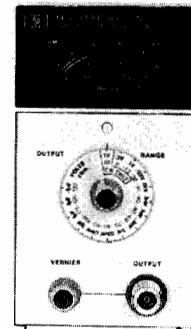
86603A
(11661B required)

RF Section Specifications (cont.)

		86601A	86602B (requires 11661B)	86603A (requires 11661B)		
		0.01-110 MHz	1-1300 MHz	1-1300 MHz	1300-2600 MHz	
OUTPUT CHARACTERISTICS	Output Level (into 50 Ω)	+13 dBm to -146 dBm	+10 to -146 dBm	+10 to -136 dBm	+7 to -136 dBm ³	
	Output Accuracy (local and remote)	± 1 dB, +13 to -66 dBm ± 2 dB, -66 to -146 dBm	± 1.5 to -76 dBm ± 2.0 to -146 dBm	± 2.5 dB to -76 dBm ³ ± 3.5 dB to -136 dBm		
	Flatness (output level variation with frequency)	$< \pm 0.75$ dB	$< \pm 1.0$ dB	$< \pm 2.0$ dB (1-2600 MHz)		
	Impedance	50 Ω				
MODULATION CHARACTERISTICS	AM	AM Modulation Depth	0 to 95%	0 to 90% ⁴	0 to 50% ⁴	
		3 dB Bandwidth:	0-30%	200 Hz, CF < 0.4 MHz 10 kHz, 0.4 \leq CF < 4 MHz 100 kHz, CF \geq 4 MHz	10 kHz, CF < 10 MHz 100 kHz, CF \geq 10 MHz	10 kHz
			0-70%	125 Hz, CF < 0.4 MHz 6 kHz, 0.4 \leq CF < 4 MHz 60 kHz, CF \geq 4 MHz	6 kHz, CF < 10 MHz 60 kHz, CF \geq 10 MHz	N/A
			0-90%	100 Hz, CF < 0.4 MHz 5 kHz, 0.4 \leq CF < 4 MHz 50 kHz, CF \geq 4 MHz	5 kHz, CF < 10 MHz 50 kHz, CF \geq 10 MHz	N/A
	Distortion, ⁵ THD at 30% AM at 70%AM at 90%AM		$< 1\%$, 0.4-110 MHz $< 3\%$, 0.4-110 MHz $< 5\%$, 0.4-110 MHz	$< 1\%$ $< 3\%$ $< 5\%$	$< 5\%$ N/A N/A	
	FM	FM Rate	dc to 1 MHz with 86632B 20 Hz to 100 kHz with 86633B	dc to 200 kHz with 86632B and 86635A 20 Hz to 100 kHz with 86633B		
		Maximum Deviation (peak)	1 MHz with 86632B 100 kHz with 86633B	200 kHz with 86632B and 86635A 100 kHz with 86633B	400 kHz w/86632B, 86635A 200 kHz w/86633B	
		Distortion, THD (at rates up to 20 kHz)	$< 1\%$ up to 200 kHz dev. $< 3\%$ up to 1 MHz dev.	$< 1\%$ up to 200 kHz dev. $< 1\%$ up to 400 kHz dev.		
	PULSE	Pulse Rise/Fall Time	200 ns	50 ns		
		ON/OFF Ratio (with pulse level control at max.)	> 50 dB	> 40 dB > 60 dB		
PM	μ M Rate	N/A	dc to 1 MHz with 86635A dc to 1 MHz for CF < 100 MHz with 86634A dc to 10 MHz for CF \geq 100 MHz			
	Maximum Peak Deviation	N/A	0 to 100 degrees 0 to 200 degrees			
	Distortion, THD	N/A	$< 5\%$ up to 1 MHz rates $< 7\%$ up to 5 MHz rates $< 15\%$ up to 10 MHz rates			
GENERAL	Weight	Net 5 kg (11 lb) Shipping 6.8 kg (15 lb)	Net 4.1 kg (9 lb) Shipping 5.5 kg (12 lb)	Net 5 kg (11 lb) Shipping 6.4 kg (14 lb)		
		11661B: Net 2.3 kg (5 lb), shipping 2.7 kg (6 lb)				

3. For +3 to +7 dBm output levels, output accuracy and flatness will be slightly degraded (above 1300 MHz only).

4. For RF output level meter readings from +3 dB to -6 dB and only at +3 dBm and below.

5. Applies only at 400 Hz and 1 kHz rates with output meter set between 0 and +3 dB. At -6 dB meter setting the distortion approximately doubles.

6. Phase modulation is only possible with Option 002 RF Sections.

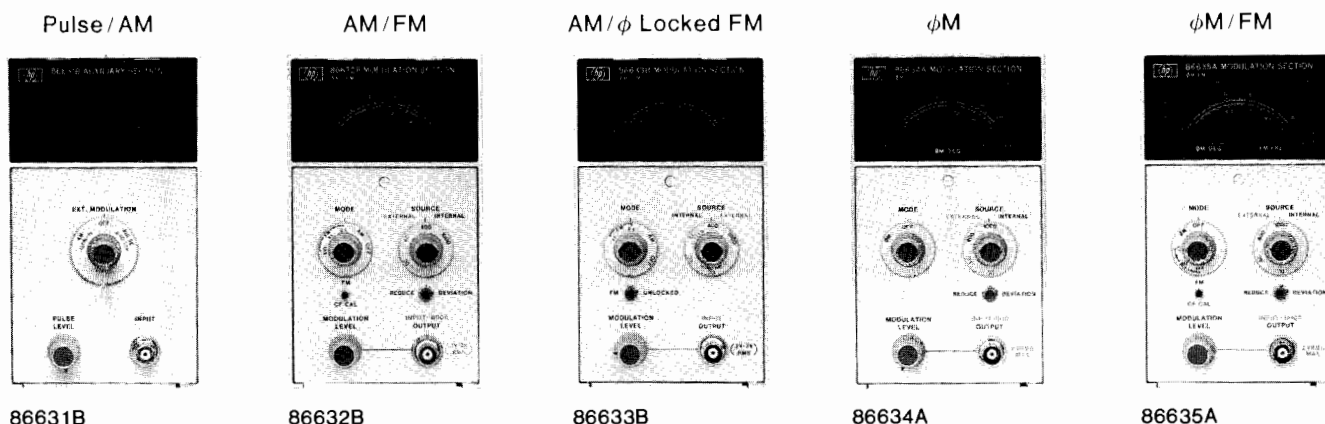

Modulation Section Specifications

		86631B	86632B	86633B	86634A	86635A
AM	Functions	Ext. Only	Int. and Ext.	Int. and Ext.	—	—
	Indicated Accuracy (at 400 and 1000 Hz rates)	—	± 5% of full scale With 86601A RF Section: ± 7%, center frequency ≥ 100 MHz With 86603A RF Section: ± 10%, center frequency ≥ 1300 MHz.		—	—
FM	Functions	—	Int. and Ext., FM CF CAL	Int. and Ext.	—	Int. and Ext., FM CF CAL
	Center Frequency Long Term Stability	—	Typically less than 200 Hz/h	Same as in CW Mode (3 x 10 ⁻⁶ /day)	—	Typically less than 200 Hz/h
	Indicated Accuracy (up to 20 kHz rates)	—	± 5% of full scale		—	± 5% of full scale
Pulse	Functions	Ext. Only	—	—	—	—
φM	Functions	—	—	—	Int. and Ext.	Int. and Ext.
	Indicated Accuracy (15°C to 35°C)	—	—	—	± 5% of full scale up to 100 kHz rates ± 8% of full scale up to 2 MHz rates ± 15% of full scale up to 10 MHz rates	
Meter		—	0—100% AM 0—10, 100, 1000 kHz FM Pk. Dev. (0—20, 200, 2000 kHz FM for CF ≥ 1300 MHz)	0—100% AM 0—10, 100 kHz FM Pk. dev. (0—20, 200 kHz FM for CF ≥ 1300 MHz)	0—100° Peak φM (0—200° for CF ≥ 1300 MHz)	0—10, 100, 1000 kHz FM, 0—100° Pk φM (0—20, 200, 2000 kHz FM, 0—200° Pk. φM for CF ≥ 1300 MHz)
Internal Modulation Source Output		None	400 Hz and 1 kHz ± 5% 200 mV minimum into 10kΩ. Available at front panel BNC connector			
Input Impedance		50Ω Pulse 600Ω AM	600Ω	600Ω	50Ω	600Ω
Weight		Net. 1.4 kg (3 lb) Shipping, 2.3 kg (5 lb)	Net. 2.7 kg (6 lb) Shipping, 4.1 kg (9 lb)	Net. 2.7 kg (6 lb) Shipping, 4.1 kg (9 lb)	Net. 1.8 kg (4 lb) Shipping, 3.2 kg (7 lb)	Net. 2.7 kg (6 lb) Shipping, 4.1 kg (9 lb)

Ordering Information

8660A Synthesized Signal Generator Mainframe \$8000

8660C Synthesized Signal generator Mainframe \$10,950

Options for 8660A, 8660C

- Option 001:** ± 3 x 10⁻⁹/day internal reference oscillator add \$210
- Option 002:** no internal reference oscillator less \$300
- Option 003:** operation from 50 to 400 Hz line add \$155
- Option 004:** 100 Hz frequency resolution (200 Hz above 1300 MHz) less \$350
- Option 005:** HP-IB programming interface \$250
- Note:** HP-IB cables not supplied, see page 30.
- Option 009:** (8660A only) LED display indicates selected frequency in 1-2-4-8 BCD code add \$210
- Option 100:** 11661B factory installed inside mainframe add \$4600
- Option 908:** Rack Flange Kit \$22.50
- 86601A** 0.01–110MHz RF Section \$4500

Price

- 86602B** 1–1300 MHz RF Section \$5800
- 86603A** 1–2600 MHz RF Section \$8500
- Note:** 86602B and 86603A RF sections require an 11661B for operation.
- Option 001:** no RF output attenuator (all RF Sections) less \$600
- Option 002:** adds phase modulation capability (86602B, 86603A only) add \$1800
- Option 003:** allows operation of 86603A with 8660A mainframe add \$250
- 11661B** Frequency Extension Module \$4600
- 86631B** Auxiliary Section \$400
- 86632B** AM/FM Modulation Section \$2500
- 86633B** AM/FM Modulation Section \$2700
- 86634A** φM Modulation Section \$1950
- 86635A** φM/FM Modulation Section \$2950
- 11672A** Service Accessory Kit \$650
- 11707A** Test Plug-in \$1300

SIGNAL GENERATORS

Mechanically Tuned VHF Generator

Models 8640A, 8640B

- 0.5 to 512 MHz frequency range with optional coverage to 1024 MHz
- +19 to -145 dBm output power range
- Low SSB phase noise
- Calibrated, metered AM, FM, and pulse modulation
- 8640B also features: internal phase lock/synchronizer, digital frequency readout, external count capability to 550 MHz

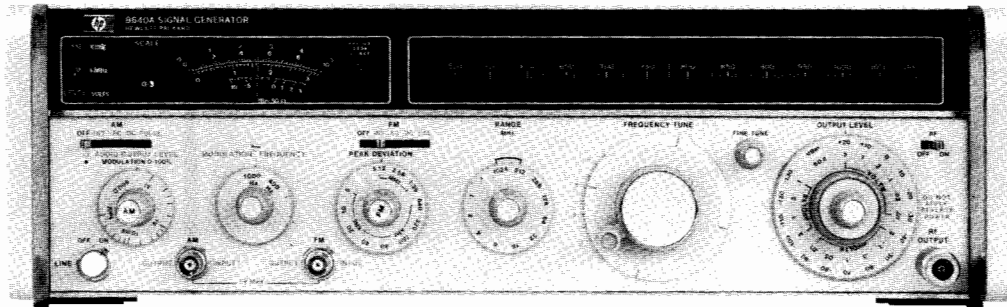

8640A (with Option 002)

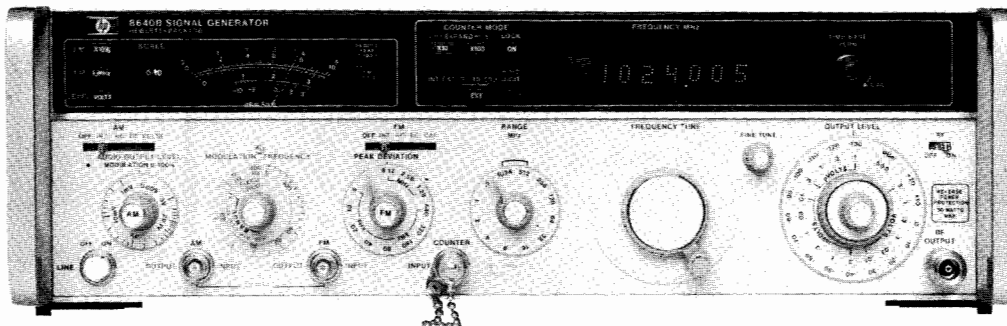

8640B (with Option 001, 002, 003)

8640A and 8640B Signal Generators

The 8640 Signal Generator covers the frequency range 500 kHz to 512 MHz (450 kHz to 550 MHz with band overrange) and can be extended to 1024 MHz with an internal doubler (Opt 002). Using the 11710B Down Converter, the 8640 frequency range can be extended down to 10 kHz. An optional audio oscillator (Opt 001) is also available with a frequency range of 20 Hz to 600 kHz. This broad coverage, together with calibrated output and modulation, provides for complete RF and IF performance tests on virtually any type of HF, VHF, or UHF receiver.

Both solid state generators, 8640A and B have an output level range of +19 to -145 dBm (2V to 0.013 μ V) which is calibrated, metered, and leveled to within ± 0.5 dB across the full frequency range of the instrument.

The 8640A and 8640B generators provide AM, FM, and pulse modulation for a wide range of receiver test applications. This modulation is calibrated and metered for direct readout under all operating conditions.

A reverse power protection option (Opt 003) is available to eliminate instrument damage due to accidental transmitter keying. This module protects against up to 50 watts of applied power and automatically resets upon removal of the reverse power.

Spectrally Pure Output Signals

Noise performance of the 8640 is state-of-the-art for a solid-state generator. The high-Q cavity oscillator has been optimized with use of a low-noise microwave transistor for spectrally pure output signals. At a 20 kHz offset from the carrier, SSB phase noise is < -130 dBc for carrier frequencies from 230 to 450 MHz, and rises to -122 dBc at 550 MHz. The SSB phase noise level decreases by approximately 6 dB for each division of the output frequency down to the broadband noise floor of better than 140 dB/Hz. This exceptional noise performance is also preserved during FM modulation and in the phase-locked mode of the 8640B.

Mechanical Dial or Built-in Counter

There are two versions of the 8640 Signal Generator. The 8640A has an easy-to-read slide rule dial with scales for each of the 10 output frequency ranges. There is an additional scale to provide direct readout of the output frequency even in the Option 002 INTERNAL DOUBLER band, 512-1024 MHz.

The 8640B combines the same performance features as the 8640A with a built-in 550 MHz frequency counter and phase lock synchronizer.

The internal 6 digit counter displays the output frequency and can also be used to count external input signals from 20 Hz to 550 MHz. This eliminates the need for a separate frequency counter in many measurement systems.

Internal Pushbutton Synchronizer

At the push of a button, the 8640B built-in phase lock synchronizer locks the RF output frequency to the crystal time base used in the counter. In this locked mode, the output stability is better than 5×10^{-6} /h and the spectral purity and FM capability of the unlocked mode are preserved. For higher stability, it is possible to lock to an externally applied 5 MHz standard. Two 8640B's can also be locked together for various 2-tone measurements.

In the phase locked mode, increased resolution is available by using the $\frac{1}{2}$ digit increment button. For example, 500 Hz resolution is possible for frequencies between 100 and 1000 MHz.

FM While Phase Locked

In the phase locked mode, full FM capability is preserved down to modulation rates of 50 Hz. The narrow bandwidth of the phase lock loop (< 5 Hz) provides for FM modulation up to 250 kHz rates and assures no degradation in noise from the unlocked mode. This crystal stability, coupled with the precision modulation and low noise, makes the 8640B ideal for testing narrowband FM or crystal-controlled receivers.

8640A and 8640B Specifications

(See technical data sheet for complete specifications.) All specifications apply over the nominal frequency ranges and over the top 10 dB of the output level vernier range unless otherwise specified.

Frequency

Range: 500 kHz to 512 MHz in 10 octave ranges (to 1024 MHz with option 002 internal frequency doubler).

Ranges and range overlap: ranges extend approximately 10% below and 7% above the nominal frequency ranges shown below.

Frequency ranges (MHz)		
0.5-1	8-16	128-256
1-2	16-32	256-512
2-4	32-64	512-1024
4-8	64-128	(opt 002)

Fine Tuning

8640A and 8640B unlocked: >1000 ppm total range.

8640B locked mode: > ±20 ppm by varying internal time base vernier.

Internal counter resolution (8640B unlocked):

Frequency Ranges (MHz)	Normal Mode	Expand X10	Expand X100
0.5-1	10 Hz	1 Hz	0.1 Hz
1-16	100 Hz	10 Hz	1 Hz
16-128	1 kHz	100 Hz	10 Hz
128-1024	10 kHz	1 kHz	100 Hz

Optimum counter resolution when phase-locked (8640B):

Frequency Ranges (MHz)	With 6 Digits	+ $\frac{1}{2}$ Digit
0.5-0.9999995	1 Hz	0.5 Hz
1.0-9.999995	10 Hz	5 Hz
10.0-99.99995	100 Hz	50 Hz
100.0-999.9995	1 kHz	500 Hz
1000-1024	10 kHz	5 kHz

Accuracy:

8640A: mechanical dial; accuracy better than ±1.0%, resetability better than 0.1%.

8640B: 6½ digit LED display with X10 and X100 expand; accuracy depends on internal or external reference used.

Stability (after 2 hour warmup):

Normal: <10 ppm/10 min.

Locked: (8640B) <0.05 ppm/h.

Restabilization time after frequency change:

Normal: <15 min.

Locked (8640B): <1 min. after relocking to be within 0.1 ppm of steady state frequency.

Output

Range: 10 dB steps and 18 dB vernier provide the following output power settings into 50Ω.

Frequency Range (MHz)	8640A/B	With Option(s)		
		002	003	002/003
0.5 to 512	+19 to -145 dBm	+18.5 to -145 dBm	+18.5 to -145 dBm	+18 to -145 dBm
512 to 1024 (Option 002)		+13 to -145 dBm		+12 to -145 dBm

Level flatness (referred to output at 50 MHz and applies to 1 V range and for top 10 dB of vernier range)

Frequency Range (MHz)	8640A 8640B	With Option(s)		
		002	003	002/003
0.5 to 64	±0.5 dB	±0.5 dB	+0.75 dB -1.25 dB	+1.0 dB -2.0 dB
64 to 512		±1.0 dB		
512 to 1024 (Option 002)		±1.5 dB		±2.0 dB

Level accuracy: (worst case as indicated on level meter) ±1.5 dB to ±4.5 dB depending on level, frequency, and options installed.

Spectral Purity

Harmonics (at 1 volt, +10 dBm output range and below):

>30 dB below fundamental, 0.5 to 512 MHz.

>12 dB below fundamental, 512 to 1024 MHz (option 002).

Spurious output signals (excluding frequencies within 15 kHz of the signal whose effects are specified in residual AM and FM)

Frequency Range (MHz)	Subharmonically Related		Non-harmonically Related	
	8640A	8640B	8640A	8640B
0.5 to 512	none detectable	>100 dBc	none detectable	>100 dBc
512 to 1024 (Option 002)	>20 dBc ¹			

¹dBc = dB below the carrier.

Residual AM (averaged rms): 0.3 to 3 kHz post-detection noise bandwidth >85 dBc.

Residual FM (averaged rms): 0.3 to 3 kHz post-detection noise bandwidth. (CW and up to ¼ maximum allowable peak deviation.)

0.5 to 512 MHz: <5 Hz.

512 to 1024 MHz: <10 Hz.

Measured SSB noise (typical): in graph below, triangular markers indicate specified limits.

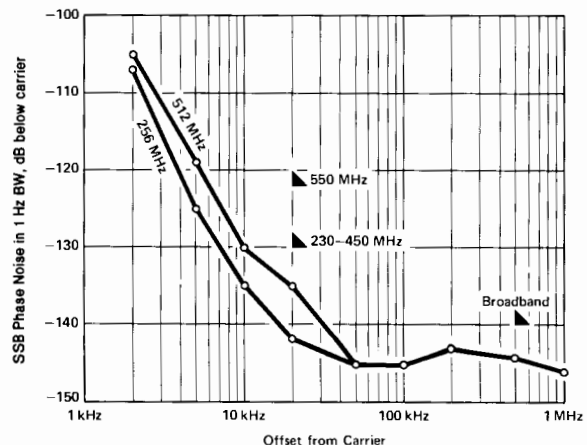



Modulation

General

Types: Internal AM and FM; External AM, FM, and PULSE; simultaneous AM and FM or PULSE and FM.

Internal modulation sources (independently adjustable output level is available at front panel):

Standard: 8640A or 8640B.

Frequency: fixed 400 Hz and 1 kHz, $\pm 3\%$.

Output level: 10 mV to 1 V rms into 600 Ω .

Optional (internal variable audio oscillator Option 001, 8640A or 8640B):

Frequency: variable 20 Hz to 600 kHz, $\pm 15\%$ plus fixed 400 Hz and 1 kHz $\pm 3\%$.

Output level: 1 mV to 3 V rms into 600 Ω .

Amplitude Modulation

Depth:

0.5 to 512 MHz: 0 to 100% for output levels from +13 dBm and below.

512 to 1024 MHz: 0 to 100% for output levels of +7 dBm and below, excluding the top 6 dB of output vernier range.

AM Rates: INT and EXT ac, 20 Hz to AM 3 dB bandwidth; EXT dc, dc to AM 3 dB bandwidth.

AM 3 dB bandwidth:

Frequency Ranges	0 to 50% AM	50 to 90% AM
0.5 to 2 MHz	20 kHz	12.5 kHz
2 to 8 MHz	40 kHz	25 kHz
8 to 512 MHz	60 kHz	50 kHz
512 to 1024 MHz	60 kHz	50 kHz

AM distortion (at 400 Hz and 1 kHz rates):

Frequency Ranges	0 to 30% AM	30 to 50% AM	50 to 90% AM
0.5 to 512 MHz	<1%		<3%
512 to 1024 MHz	<10%		<20%

External AM sensitivity (400 Hz and 1 kHz rates):

0.5 to 512 MHz: (0.1 \pm 0.005)% AM per mV peak into 600 Ω with AM vernier at full clockwise position.

512 to 1024 MHz: nominal 0.1% AM per mV peak into 600 Ω with AM vernier at full clockwise position.

Indicated AM accuracy (400 Hz and 1 kHz rates using internal meter):

0.5 to 512 MHz: $\pm 5.5\%$ of reading $\pm 1.5\%$ of full scale from 0 to 50 $^{\circ}$ C.

512 to 1024 MHz: not specified; each generator can be individually calibrated using operating manual procedure.

Peak incidental phase modulation (at 30% AM):

0.5 to 128 MHz: <0.15 radian.

128 to 512 MHz: <0.3 radian.

512 to 1024 MHz: <0.6 radian.

Peak incidental frequency deviation: equals peak incidental phase modulation x modulation rate.

Pulse Modulation¹

	Frequency Ranges (MHz)					
	0.5-1	1-2	2-8	8-32	32-512	512-1024
Rise and Fall Times	<9 μ s	<4 μ s	<2 μ s	<1 μ s		<1 μ s typical
Pulse Repetition Rate	50 Hz to 50 kHz		50 Hz to 100 kHz	50 Hz to 250 kHz	50 Hz to 500 kHz	
Pulse Width Minimum ²	10 μ s		5 μ s	2 μ s		
Pulse ON/OFF ratio at max. vernier	>40 dB				>60 dB	
Peak Input Required	Nominally +0.5 V (5 V max). Sinewave or pulse return to zero into 50 Ω					

¹Pulse performance degrades below 500 Hz repetition rates.

²For level accuracy within 1 dB of CW (>0.1% duty cycle).

Frequency Modulation

Deviation: maximum allowable deviation equals 1% of lowest frequency in each nominal output frequency range.

Frequency Range (MHz)	Maximum Peak Deviation (kHz)
0.5-1	5
1-2	10
2-4	20
4-8	40
8-16	80
16-32	160
32-64	320
64-128	640
128-256	1280
256-512	2560
512-1024	5120

FM 3 dB Bandwidth: internal and external ac, 20 Hz to 250 kHz; external dc, dc to 250 kHz. (8640B locked mode: FM above 50 Hz only.)

FM distortion (at 400 Hz and 1 kHz rates):

<1% for deviations up to $\frac{1}{2}$ maximum allowable.

<3% up to maximum allowable deviation.

External FM sensitivity: 1 volt peak into 600 Ω yields maximum deviation indicated on PEAK DEVIATION switch with FM vernier at full clockwise position.

Indicated FM accuracy (400 Hz and 1 kHz rates from 15 $^{\circ}$ to 35 $^{\circ}$ C, using internal meter): $\pm 7\%$ of reading +1.5% of full scale.

Incidental AM (at 400 Hz and 1 kHz rates)

0.5 to 512 MHz: <0.5% AM for FM up to $\frac{1}{2}$ maximum allowable deviation; <1% AM for FM at maximum allowable deviation.

512 to 1024 MHz (Opt 002): <1% AM for FM up to $\frac{1}{2}$ maximum allowable deviation; <7% AM for FM deviations up to maximum allowable.

Counter (8640B)

External RF Input

Frequency range: 1 Hz to 550 MHz.

Sensitivity: ≥ 100 mV rms into 50 Ω , ac only.

Resolution: 6-digit LED display.

Mode	Normal	Expand X10	Expand X100
0-10 MHz	100 Hz	10 Hz	1 Hz
10-550 MHz	10 kHz	1 kHz	100 Hz

External reference input: 5 MHz, nominally >0.5 V p-p (5 V maximum) into 1 k Ω .

Internal Reference (after 2 h warm-up and calibration at 25 $^{\circ}$ C)

Aging Rate: <0.05 ppm/h; <2 ppm/90 days.

Temperature Drift:

< ± 2 ppm from 15 $^{\circ}$ to 35 $^{\circ}$ C.

< ± 10 ppm from 0 $^{\circ}$ to 50 $^{\circ}$ C.

Typical Overall Accuracy (within 3 months of calibration and from 15 $^{\circ}$ to 35 $^{\circ}$ C): ± 2 ppm.

General

Operating temperature range: 0 to 55 $^{\circ}$ C.

Power Requirements: 100 or 120 volts (+5%, -10%) from 48 to 440 Hz; or 220 or 240 volts (+5%, -10%) from 48 to 66 Hz. 175 VA max (Option 002: 190 VA max).

Weight (8640A and 8640B): net, 20.8 kg (46 lb); shipping, 24.1 kg (53 lb).

Size: 140 H x 425 W x 476 D (5.5" x 16.75" x 18.75").

Ordering Information

8640A Signal Generator Price \$6900

8640B Signal Generator Price \$8000

Option 001: internal variable audio oscillator, 20 Hz to 600 kHz (8640A/B)

add \$300

Option 002: internal doubler 512-1024 MHz (8640A/B)

add \$900

Option 003: reverse power protection (8640A/B)

add \$300

Option 004: avionics option (8640B only)

add \$1000

Option 90B: rack mount kit (8640A/B)

add \$22

Option 910: extra operating and service manual (8640A/B)

add \$25

- Demodulated output from RF detector, ac and dc

- Phase shift less than 0.01° at 30 Hz

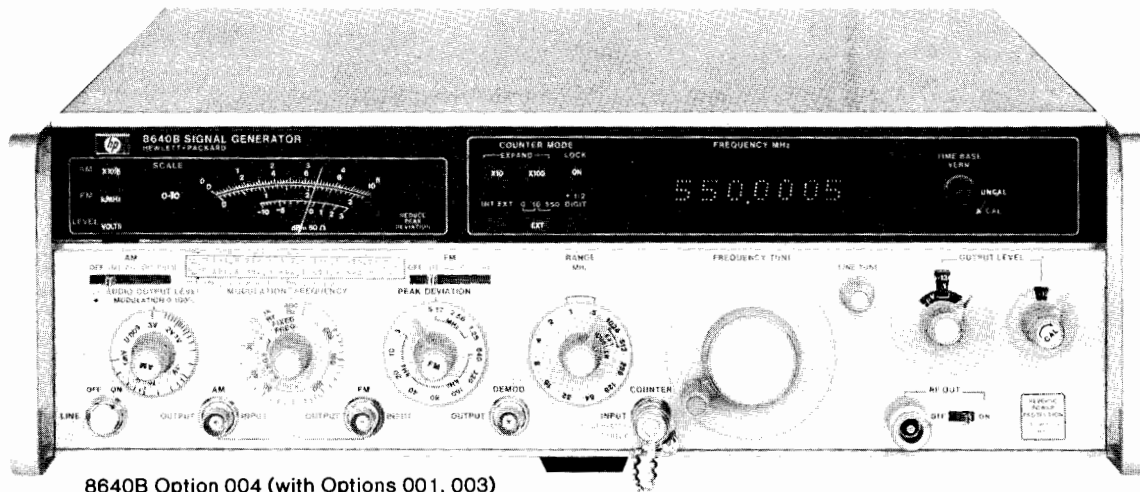

8640B Option 004 (with Options 001, 003)

8640B Avionics Option 004 Signal Generator

The Hewlett-Packard Model 8640B Option 004 NAV/COM Signal Generator is an 8640B AM/FM Signal Generator specially adapted for testing ILS (Marker Beacon, Localizer and Glide Slope), VOR and VHF communications receivers used throughout the aviation industry. VOR, LOCALIZER and VHF communications frequencies (108 to 136 MHz) are available on one frequency band for rapid channel selection. GLIDE SLOPE (329 to 335 MHz) and MARKER BEACON (75 MHz) frequencies are also easily set using the 6-digit LED display.

The 8640B Option 004 provides highly stable, spectrally pure RF signals for testing narrow-channel, crystal controlled receivers. For avionics testing, external audio generators are required to provide the composite modulation. Designed with versatile AM and FM modulation, Option 004 features low distortion modulation when used with suitable, external VOR/ILS Audio Generators.

Operation and specifications of the 8640B Option 004 are the same as the Standard 8640B AM/FM Signal Generator with the following additions:

Demodulated Output

One front panel BNC connector provides demodulated output from the RF peak detector for precise AM settings. A choice of combined ac/dc at 1 V rms or ac only at 5 V rms is provided.

Output Level Setting

To ensure the best possible demodulated output linearity, Option 004 combines a 10 dB step attenuator and a 1 dB step attenuator with a vernier. This provides output levels from +15 dBm to -142 dBm (1.3 V to 0.018 μ V). The output level can be read directly from the attenuator dial in dBm or from the front panel meter in dBm or volts.

External AM Input Impedance

External AM input impedance of 2 k Ω allows compatible operation with old and new generations of external audio generators.

Low Distortion Modulation

The 8640B Option 004 provides flat AM response and minimum phase shift at 30 Hz and 9960 Hz as well as constant group delay between 9 kHz and 11 kHz for accurate VOR and ILS testing.

8640B Option 004 Specifications

(These specifications apply to 8640B Option 004 in addition to standard 8640B specifications. See 8640B AM/FM Signal Generator technical data for complete specifications.)

Spectral Purity

Noise: SSB broadband noise floor greater than 1 MHz offset from carrier: > 130 dB down.

Output Characteristics

Range: +15 dBm to -142 dBm (1.3 V to 0.018 μ V).

Attenuators: a 10 dB step attenuator plus a 1 dB step attenuator with vernier allow selection of any output level over the full output level range.

Vernier: 2 dB continuously variable from a CAL detent position.

Level flatness (referred to 190 MHz and for +10 to -10 dBm): < ± 0.75 dB from 0.5 to 512 MHz; < ± 0.5 dB from 108 to 336 MHz.

Level accuracy:

Output Level (dBm)	+15 to -10	-10 to -50	-50 to -142	With Option 003
Total Accuracy as Indicated on Level Meter	± 1.5 dB	± 2.0 dB	± 2.5 dB	Add ± 0.5 dB except from 108 to 336 MHz

Modulation Characteristics

Demodulated output (Output vernier in CAL position, 108 to 118 and 329 to 336 MHz): an internal selector switch allows selection of ac only or ac and dc at the demodulated output.

AC only output: directly proportional to AM depth (90 to 150 Hz modulation frequency).

%AM equals: (20 \pm 0.6)% per V rms, 0 to 55°C; (20 \pm 0.4)% per V rms, 20 to 30°C; (20 \pm 0.2)% per V rms (using calibration sheet provided).

AC and DC output: AC output voltage is directly proportional to AM depth (90 to 150 Hz modulation frequency). DC output equals (1.414 \pm 0.010) V dc with vernier in CAL position.

%AM equals: (100 \pm 3)% per V rms, 0 to 55°C; (100 \pm 2)% per V rms, 20 to 30°C; (100 \pm 1)% per V rms (using calibration sheet provided).

AM Characteristics (+10 dBm Output and Below)

External input impedance: nominally 2 k Ω .

Frequency response: < 0.04 dB from 90 Hz through 150 Hz (108 to 118 and 329 to 335 MHz.); < 0.1 dB, 9 kHz through 11 kHz (108 to 118 MHz); ± 3 dB (0 to 50% AM), dc through 50 kHz (8 to 512 MHz); ± 3 dB (0 to 70% AM), dc through 35 kHz (8 to 512 MHz).

Phase shift from audio input to demodulated output (108 to 118 MHz, AM EXT DC mode, meter function on VOLTS):

30 Hz < $\pm 0.01^\circ$; 30 Hz to 10 kHz < $\pm 3^\circ$; 9 kHz to 11 kHz < $\pm 2^\circ$.

Ordering Information

8640B Signal Generator with Avionics Option 004 \$9000

Option 001: Internal variable audio oscillator, 20 Hz to 600 kHz add \$300

Option 002: not available with Option 004

Option 003: Reverse power protection add \$300

Option 908: Rack mount kit add \$22

Option 910: Extra Operating and Service Manual add \$25

SIGNAL GENERATORS

Rugged Solid-State Generator 10 to 520 MHz

Models 8654A, 8654B

- Calibrated output power
- Calibrated AM, FM; internal, external
- 25 Watt reverse power protection (optional)

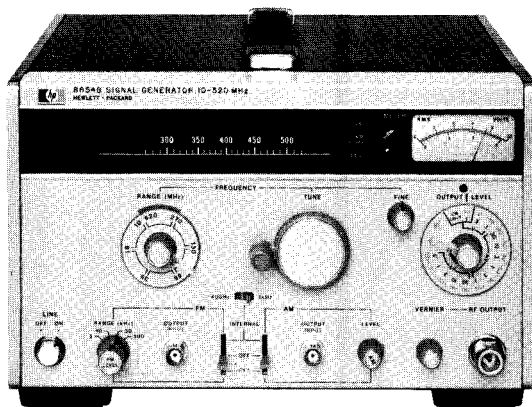

8654B

8654A/B Signal Generators

The HP 8654A/B Signal Generators are portable, low-cost solid-state generators providing calibrated output and versatile modulation capabilities over the 10 to 520 MHz frequency range. The 8654 provides clean RF signals for testing receivers, amplifiers, antennas, and filter networks.

Its compactness allows the 8654 to fit easily into production, mobile, airborne, and shipboard test locations. Its rugged, lightweight construction is also suitable for field maintenance and service applications.

A front-panel meter accurately indicates amplitude modulation depth from 0 to 90%. Additionally, the 8654B provides calibrated and metered FM over four deviation ranges. FM on the 8654A is uncalibrated.

Effective RF shielding and output range permit receiver sensitivity measurements to be made down to power levels of 0.1 μ V.

8654A/B Specifications

Specifications apply from 10 to 520 MHz for output power \leq +10 dBm and over the top 10 dB of output level vernier range unless otherwise specified.

Frequency Characteristics

Range: 10 to 520 MHz in 6 ranges.

8654A ranges (MHz): 10 to 18.6, 18.6 to 35, 35 to 66, 66 to 130, 130 to 250, 250 to 520.

8654B ranges (MHz): 10 to 19, 19 to 35, 35 to 66, 66 to 130, 130 to 270, 270 to 520.

Accuracy: \pm 3% after 2-hour warm-up.

Settability: settable to within 5 ppm of the desired frequency with an external indicator after 1-hour warm-up.

Stability (after 2-hour warm-up and 15 min. after frequency change): $<$ (1 kHz plus 20 ppm)/5 min.

Spectral Purity

Harmonic distortion (output power \leq +3 dBm): $<$ -20 dBc; $<$ -15 dBc with Option 003.

Subharmonics and non-harmonic spurious (excluding line related): $<$ -100 dBc.

Residual AM (average rms): $<$ -55 dBc in a 50 Hz to 15 kHz post-detection noise bandwidth.

Residual FM on CW (averaged rms deviation): $<$ 0.3 ppm in a 0.3 to 3 kHz post-detection noise bandwidth; $<$ 0.5 ppm in a 50 Hz to 15 kHz post-detection noise bandwidth.

Output Characteristics

Range: 10 dB steps and a 13 dB vernier provide power settings from +10 dBm to -130 dBm (0.7 V to 0.07 μ V) into 50 Ω . With Option 003, maximum output power is +8 dBm (0.56 V).

Impedance: 50 Ω ac coupled. SWR $<$ 1.3 on 0.1 V range or lower. With Option 003, SWR $<$ 1.5 on 0.1 V range or lower.

Level accuracy (total as indicated on level meter): +10 to -7 dBm, \pm 1.5 dB; -7 to -57 dBm, \pm 2.0 dB; -57 to -97 dBm, \pm 2.5 dB; -97 to -127 dBm, \pm 3 dB.

Level flatness: \pm 1 dB referenced to the output at 250 MHz for output levels $>$ -7 dBm.

Auxiliary RF output: $>$ -7 dBm (100 mV) into 50 Ω .

Leakage (with all RF outputs terminated properly): leakage limits are below those specified in MIL-I-6181D. With an output level $<$ 0.01 V, less than 0.5 μ V is induced in a 2-turn, 25 mm diameter loop 25 mm away from any surface and measured into a 50 Ω receiver.

Reverse power protection (Option 003): protects signal generator from accidental applications of up to 25 W (+44 dBm) of RF power (between 10 and 520 MHz) into generator output.

Modulation Characteristics

Amplitude modulation: specifications apply for output power $<$ +3 dBm.¹

Depth: 0 to 90%.

Modulation rate: internal, 400 and 1000 Hz \pm 10%; external 3 dB bandwidth, dc to $>$ 20 kHz.

External AM sensitivity:² (0.1 \pm 0.01)% AM/mV pk into 600 Ω .

Indicated AM accuracy:² \pm (5% of reading +5% of full scale).

Peak incidental frequency deviation (30% AM):² $<$ 200 Hz.

Envelope distortion:² $<$ 3%, 0 to 70% modulation; $<$ 5%, 70 to 90% modulation.

Frequency Modulation

8654B: fully calibrated.

Peak deviation: 0 to 30 kHz from 10 to 520 MHz.

0 to 100 kHz from 80 to 520 MHz.

Deviation ranges: 0 to 3 kHz, 0 to 10 kHz, 0 to 30 kHz, 0 to 100 kHz.

Modulation rate: internal, 400 and 1000 Hz \pm 10%; external 3 dB bandwidth, dc to $>$ 25 kHz.

FM distortion:² $<$ 2% for deviations up to 30 kHz, $<$ 3% for deviations up to 100 kHz.

External FM sensitivity (with FM vernier fully clockwise):² 1 volt peak yields maximum deviation indicated on peak deviation meter.

Sensitivity accuracy (15° to 35°C):² \pm 12%. For 100 kHz deviation above 130 MHz, add 3%.

Indicated FM accuracy (15° to 35°C):² \pm (12% of reading +3% of full scale). For 100 kHz deviation above 130 MHz, add 3% of reading.

Incidental AM:² $<$ 1% AM at 30 kHz deviation.

Frequency modulation, 8654A: uncalibrated.

Deviation: $>$ 0.1% of carrier frequency, maximum.

Modulation rate: internal, 400 & 1000 Hz \pm 10%. External 3 dB bandwidth, dc coupled to $>$ 25 kHz driven from 600 Ω or less.

External FM sensitivity: 10 V_{pk} into 600 Ω yields $>$ 0.1% deviation (\pm 15 volts max).

General Characteristics

Power: 100 or 120 volts (+5%, -10%) from 48 to 440 Hz; or 220 to 240 volts (+5%, -10%) from 48 to 66 Hz. Power consumption is 25 VA max. 2.3m (7.5 ft.) power cable furnished with mains plug to match destination requirements.

Weight: net, 8.0 kg (17.5 lb); shipping, 9.5 kg (21 lb).

Size: 178 H x 267 W x 306 mm D (7" x 10.5" x 12").

¹AM is possible above +3 dBm as long as the combination of the AM depth plus carrier output level does not exceed +9 dBm.

²400 and 1000 Hz modulation rates.

Ordering Information

8654A AM/FM Signal Generator

Price

\$2950

8654B AM/FM Signal Generator

\$3650

Option 003: Reverse power protection (for 8654A/B)

add \$300

Option 910: Extra operating and service manual

add \$10

- Stable, easy to use, 800-2400MHz, 1800-4500MHz



8614A, 8616A Signal Generators

The HP 8614A and 8616A Signal Generators provide stable, accurate signals from 800 to 2400 MHz (8614A) and from 1800 to 4500 MHz (8616A). Both frequency and attenuation are set on direct-reading digital dials. Selectable functions include CW, leveled output, square-wave modulation, and external AM, FM and pulse modulation. Modulation can be accomplished simultaneously with or without leveling.

Two RF power outputs are simultaneously available from separate front-panel connectors. One provides at least 10 mW (2 mW above 3000 MHz) or a leveled output from 0 to -127 dBm. The other is at least 0.5 mW across the band. This signal can be used for phase-locking the signal generators for extreme stability, or it can be monitored with a frequency counter for extreme frequency resolution without adversely affecting the primary output.

A unique PIN diode modulator permits amplitude modulation from dc to 1 MHz or RF pulses with a 2 μ s rise time. This broad modulation bandwidth permits remote control of output level or precise leveling using external equipment. The internal leveling is also obtained by using a PIN modulator.

The 8614A and 8616A can also be used with companion modulators, HP 8403A modulators and HP 8730-series PIN modulators to provide 80 dB pulse on/off ratio (see page 418). In addition, TWT amplifiers can be used with these generators to provide high power levels.

Specifications

8614A

Frequency range: direct reading within 2 MHz, 800 to 2400 MHz.
Vernier: ΔF control has a minimum range of 1.0 MHz for fine tuning.

Frequency calibration accuracy (0 dBm & below): ± 5 MHz.

Frequency stability: approximately 50 ppm/ $^{\circ}$ C change in ambient temperature, less than 2500 Hz peak residual FM; 30 ppm change for line voltage variation of $\pm 10\%$.

RF output power: +10 dBm (0.707 V) into 50 Ω load. Output attenuation dial directly calibrated in dBm from 0 to -127 dBm. A second uncalibrated output (approximately -3 dBm) is provided on front panel.

RF output power accuracy (with respect to attenuation dial): ± 0.75 dB + attenuator accuracy (0 to -127 dBm) including leveled output variations.

Attenuator accuracy: +0, -3 dB from 0 to -15 dBm; ± 0.2 dB ± 0.06 dB/10 dB from -15 to -127 dBm; direct reading dial, 0.2 dB increments.

Output impedance: 50 Ω ; SWR < 2.0.

Modulation: on-off ratio at least 20 dB for square wave, pulse.

Internal square wave: 950 to 1050 Hz. Square wave can be synchronized with a +1 to +10 V signal at PULSE input.

External pulse: 50 Hz to 50 kHz; 2 μ s rise time, +20 to +100 V peak input.

External AM: dc to 1 MHz.

External FM: front-panel connector capacity-coupled to repeller of klystron; four-terminal rear-panel connector (Cinch-Jones type S304AB) is dc-coupled to repeller of klystron.

Power source: 115 or 230 V $\pm 10\%$, 50 to 60 Hz, approximately 130 W.

Size: cabinet, 141 H x 425 W x 467 mm D (5.5" x 16.75" x 18.4"); rack mount, 133 H x 416 W x 483 mm D (5.2" x 16.4" x 19").

Weight: net, 19.5 kg (43 lb); shipping, 22.7 kg (50 lb).

Accessory furnished: 11500A Cable Assembly.

8616A

Frequency range: direct reading within 2MHz, 1800 to 4500 MHz.
Vernier: ΔF control has a minimum range of 1.0 MHz for fine tuning.

Frequency calibration accuracy (0 dBm & below): ± 10 MHz.

Frequency stability: approximately 50 ppm/ $^{\circ}$ C change in ambient temperature, less than 2500 Hz peak residual FM; 30 ppm change for line voltage variation of $\pm 10\%$.

RF output power: +10 dBm (0.707 V) to -127 dBm into 50 Ω load, 1800 to 3000 MHz; +3 dBm to -127 dBm from 3000 to 4500 MHz into a 50 Ω load. Output attenuation dial directly calibrated in dBm from 0 to -127 dBm. A second uncalibrated output (approximately -3 dBm) is provided on the front panel.

RF output power accuracy (with respect to attenuation dial): ± 1.0 dB + attenuator accuracy (0 to -127 dBm).

Attenuator accuracy: +1, -2 dB from 0 to -10 dBm; ± 0.2 dB ± 0.06 dB/10 dB from -10 to -127 dBm.

Output impedance: 50 Ω ; SWR < 2.0.

Modulation: on-off ratio at least 20 dB for square wave, pulse.

Internal square wave: 950 to 1050 Hz. Other frequencies available on special order.

External pulse: 50 Hz to 50 kHz; 2 μ s rise time, +20 to +100 V peak input.

External AM: dc to 1 MHz.

External FM: front panel connector capacity-coupled to repeller of klystron; four-terminal rear panel connector (Cinch-Jones type S304AB) is dc-coupled to repeller of klystron.

Power Source: 115 or 230 V $\pm 10\%$, 50 to 60 Hz, approximately 130 W.

Size: cabinet, 141 H x 425 W x 467 mm D (5.5" x 16.75" x 18.4"); rack mount, 133 H x 416 W x 483 mm D (5.2" x 16.4" x 19").

Weight: net, 19.5 kg (43 lb); shipping, 22.7 kg (50 lb).

Accessory furnished: 11500A Cable Assembly

Ordering Information

	Price
8614A Signal Generator (800-2400 MHz)	\$5950.00
8616A Signal Generator (1800-4500 MHz)	\$5950.00

8614A and 8616A Options

Option 001: External modulation input connectors on rear panel in parallel with front-panel connectors; RF connectors on rear panel only.	add \$25.00
Option 908: Rack mounting flange kit	add \$22.00
Option 910: Extra operating and service manual	add \$7.50

SIGNAL GENERATORS

SHF Signal Generators

Models 618C, 620B

- Signal simulations, 3.8-7.6 GHz, 7-11 GHz
- FM, Pulse modulation

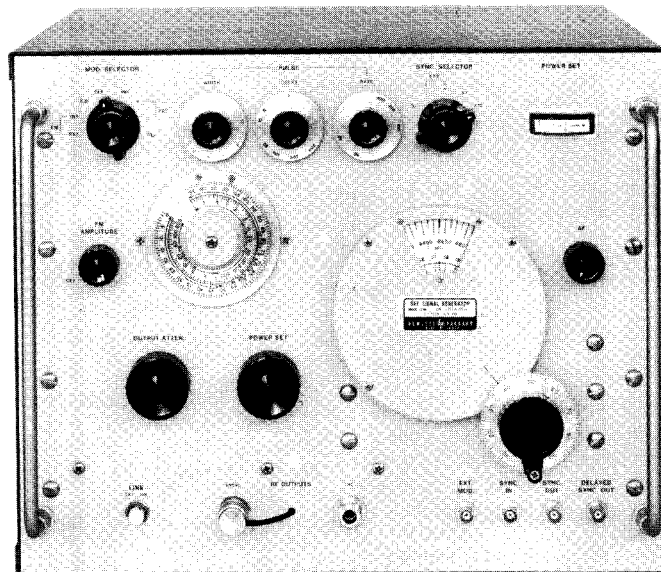

618C

618, 620B SHF Signal Generators

The Models 618C and 620B SHF Signal Generators provide versatility, accuracy, and stability in the range from 3.8 to 11 GHz. Frequency is set on a large, direct-reading dial. A ΔF vernier control provides ultra-fine tuning capability. There is also a provision for remote fine tuning.

A calibrated output from 0 to -127 dBm (0.224 volt to 0.1 microvolt) is also set on a large, direct-reading dial. The dial is calibrated in both dBm and volts. An auxiliary output of at least 0.3 milliwatt is available and is independent of attenuator setting. Thus, it can be used for phase-locking the signal generator when crystal-oscillator stability is required, or it can be monitored with a frequency counter for extreme frequency resolution.

The 618C and 620B Generators each feature a reflex klystron oscillator with an external resonant cavity. Oscillator frequency is determined by a movable plunger which varies the length of the cavity. Oscillator output is monitored by a temperature-compensated detector circuit. This circuit operates virtually unaffected by ambient temperature conditions.

Modulation includes internal pulse, square wave, and frequency modulation plus external pulse and frequency modulation.

618C, 620B Specifications

Output

Frequency Range

618C: 3.8 to 7.6 GHz in a single band.

620B: 7 to 11 GHz in a single band; repeller voltage automatically tracked and proper mode automatically selected.

Calibration: direct reading; frequency calibration accuracy better than $\pm 1\%$.

Frequency stability: with temperature, less than 60 ppm/ $^{\circ}$ C change in ambient temperature; with line voltage, less than 200 ppm change for line voltage variation of $\pm 10\%$; residual FM < 15 kHz peak.

Output range: 0 dBm to -127 dBm (0.224 volt to 0.1 microvolt) into 50 ohms; directly calibrated in dBm and volts; coaxial type N connector.

Output accuracy: within ± 2 dB from -7 to -127 dBm, within ± 3 dB from 0 to -7 dBm, terminated in 50-ohm load.

Source impedance: 50 ohms nominal; SWR < 2.0 .

Modulation

Internal pulse modulation: repetition rate variable from 40 to 4,000 pps, pulse width variable 0.5 to 10 microseconds.

Sync out signals: simultaneous with RF pulse, positive; in advance of RF pulse, positive, variable 3 to 300 microseconds (better than 1 microsecond rise time and 20 to 100 volts amplitude into 1,000-ohm load).

External synchronization: sine wave: 40 to 4,000 Hz, 5 to 50 V rms; pulse: 40 to 4,000 pps, 5 to 50 V peak, positive or negative, 0.5 to 5 μ s wide, 0.1 to 1 μ s rise time.

Internal square-wave modulation: variable 40 to 4,000 Hz.

Internal FM: sawtooth sweep rate adjustable 40 to 4,000 Hz; frequency deviation to 5 MHz peak-to-peak over most of the frequency range.

External pulse modulation: requires pulse amplitude from 15 to 70 volts positive or negative, width 0.5 to 2,500 microseconds.

External FM: frequency deviation approximately 5 MHz peak-to-peak over most of the band; sensitivity approximately 20 V/MHz at front-panel connector, approximately 10 V/MHz at rear-panel connector (mating connector supplied); front-panel connector is capacitively coupled to klystron repeller; rear-panel connector is dc-coupled to klystron repeller and is suitable for phase-lock control input.

General

RFI: Radiated interference is within the limits of VDE 0871 and CISPR publication 11.

Power source: 115 or 230 volts $\pm 10\%$, 50 to 60 Hz, approximately 230 W.

Dimensions: cabinet, 353 H x 445 W x 518 mm D (13.9" x 17.5" x 20.4"); rack mount, 355 x 483 x 483 mm (14" x 19" x 19").

Weight: net, 31.1 kg (69 lb); shipping, 33.5 (74 lb).

Accessory furnished: 11500A Cable Assembly, 1830 mm (6 ft) of RG-214A/U 50-ohm coax, terminated on each end by type N male connectors.

Ordering Information

618C or 620B SHF Signal Generator (cabinet mount)

Price

\$7250.00

618CR or 620BR SHF Signal Generator (rack mount)

\$7250.00

Option 910: Extra operating and service manual

add \$7.50

SIGNAL GENERATORS

SHF Generators, Doublers

Models 626A, 628A, 938A, 940A

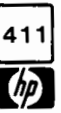

- Stable calibrated signals, 10-15.5 GHz, 15-21 GHz

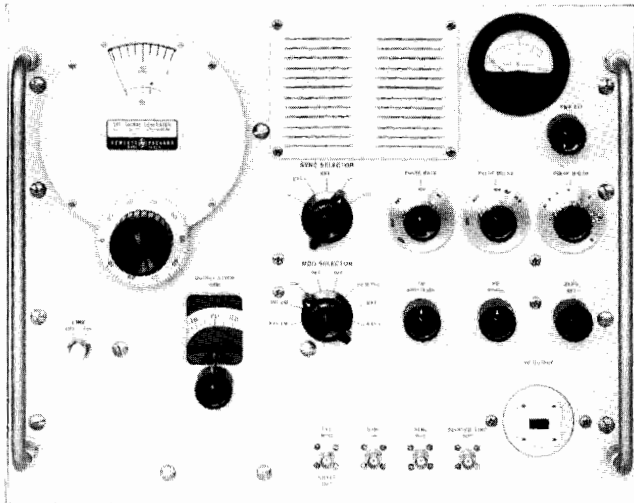

628A

626A, 628A SHF Signal Generators

The 626A covers frequencies 10 to 15.5 GHz, and the 628A covers frequencies 15 to 21 GHz. In design and operation, the instruments are similar to HP's 618C and 620B Signal Generators. Carrier frequency is set and read directly on the large tuning dial. No voltage adjustment is necessary during tuning because repeller voltage is tracked with frequency changes automatically. Oscillator output is also set and read directly, and no frequency correction is necessary throughout operating range. A frequency logging scale permits frequency to be reset within 0.1%.

Both the 626A and 628A offer internal pulse, squarewave and frequency modulation, plus external pulse and frequency modulation. The pulse generators may be synchronized with an external sine wave and positive or negative pulse signals.

The high power output of these signal generators makes them ideally suited for driving HP 938A and 940A Frequency Doubler sets. These doubler sets retain the modulation and stability of the driving source and have accurate power monitors and attenuators.

626A, 628A Specifications

- Frequency range:** 626A, 10 to 15.5 GHz; 628A, 15 to 21 GHz.
- Frequency calibration:** dial direct-reading in GHz, accuracy better than $\pm 1\%$.
- Output range:** 10 mW to 1 pW (+10 dBm to -90 dBm); attenuator dial calibrated in output dBm.
- Source SWR:** <2.5 at +10 dBm; <1.35 at 0 dBm and below.
- Output monitor accuracy:** better than ± 1 dB; temperature-compensated thermistor bridge circuit monitors RF oscillator power level.
- Output connector:** 626A: WR75 waveguide, flat cover flange, 21.6 x 12.0 mm (0.85 x 0.475 in.). 628A: WR51 waveguide, flat cover flange, 15.0 x 8.5 mm (0.59 x 0.335 in.).
- Output attenuator accuracy:** better than $\pm 2\%$ of attenuation in dB introduced by output attenuator.
- Modulation:** internal pulse, FM, or square wave; external pulse and FM.
- Internal pulse modulation:** repetition rate variable from 40 to 4000 pps; pulse width variable 0.5 to 10 μ s.

- Doubler sets for signals 18-26.5 GHz, 26.5-40 GHz

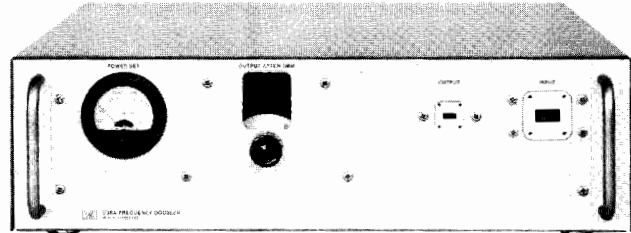

938A

- Internal square-wave modulation:** variable 40 to 4000 Hz controlled by "pulse-rate" control.
- Internal frequency modulation:** power line frequency; deviation up to ± 5 MHz.
- External pulse modulation:** requires pulse amplitude of 15 to 70 volts peak positive or negative; width 1 to 2500 μ s.
- External frequency modulation:** provided by capacitive coupling to the klystron repeller; maximum deviation approximately ± 5 MHz.
- Sync out signals:** positive 20 to 100 V peak into 1000-ohm load; better than 1 μ s rise time; 1) simultaneous with RF pulse, positive; 2) in advance of RF pulse, positive, variable 5 to 300 μ s.
- External synchronization:** sine wave, 40 to 4000 Hz, 5 to 50 V rms amplitude; pulse signals, 40 to 4000 pps, 5 to 50 V amplitude, positive or negative, 0.5 to 5 μ s width, 0.1 to 1 μ s rise time.
- Power:** 115 or 230 volts $\pm 10\%$, 50 to 60 Hz, approx. 200 watts.
- Size:** cabinet, 356 H x 432 W x 381 mm D (14" x 17" x 15"); rack mount, 356 H x 483 W x 313 mm D (14" x 19" x 12.8").
- Weight:** net, 26.8 kg (59 lb); shipping, 29.8 kg (66 lb).
- Accessories furnished:** 626A, MX 292B and MP 292B Waveguide Adapters; 628A, NP 292A and NK 292A Waveguide Adapters.
- Accessories available:** M362A low-pass filter.

938A, 940A Frequency Doubler Sets

Model 938A supplies power from 18 to 26.5 GHz and Model 940A from 26.5 to 40 GHz when driven by 9 to 13.25 GHz and 13.25 to 20 GHz sources respectively. For a swept output, use a swept-frequency source such as Model 8690B or Model 8620A/B/C series with appropriate RF units.

938A, 940A Specifications

- Frequency range:** 938A, 18 to 26.5 GHz; 940A, 26.5 to 40 GHz.
- Conversion loss:** less than 18 dB at 10 mW input.
- Output power:** approximately 0.5-1 mW when used with typical 626A, 628A signal generators; input power 100 mW maximum.
- Output attenuator:** accuracy, $\pm 2\%$ of reading or ± 0.2 dB, whichever is greater; range, 100 dB.
- Output reflection coefficient:** approx. 0.33 at full output; less than 0.2 with attenuator set to 10 dB or greater.
- Output flange:** 938A, K-band flat cover flange for WR-42 waveguide; 940A, R-band flat flange for WR-28 waveguide.
- Size:** 137 H x 489 W x 457 mm D (5.4" x 19.25" x 18").
- Weight:** net, 9 kg (20 lb); shipping, 11.8 kg (26 lb).

Ordering Information

	Price
626A or 628A SHF Signal Generator (cabinet)	\$10,100
626AR or 628AR SHF Signal Generator (rack)	\$10,100
Option 910: Extra operating & service manual	add \$7.50
938A or 940A Frequency Doubler	\$6500.00
Option 910: Extra operating & service manual	add \$1.00

SIGNAL GENERATORS

Solid-State Microwave Signal Generators

Models 8683A, 8683B, 8684A, 8684B

- Spectrally pure signals, 2.3–6.5 GHz; 5.4–12.5 GHz
- +10 to –130 dBm calibrated output
- Calibrated AM, FM and Pulse Modulation
- Communications and radar versions
- 2 kW reverse power protection (optional)
- Internal service diagnostic



8684B



8680 Microwave Signal Generators

The 8683 and 8684 are rugged, portable signal generators which provide similar capabilities in two overlapping frequency ranges. Each is available as a communications version (8683/84A) or a more versatile radar/communications version (8683/84B).

Freq. Band	Communication Appl.	Radar/Commun. Appl.
2.3–6.5 GHz	8683A	8683B
5.4–12.5 GHz	8684A	8684B

The “B” versions differ from the “A” versions by offering higher maximum leveled output power and high performance internal pulse modulation.

Clean, Stable Cavity-Tuned Oscillator

At the heart of the signal generators is their mechanically tuned-cavity oscillators. The oscillators are the result of coupling state-of-the-art electronics with sophisticated mechanical design and precision manufacturing techniques. Mechanical cavity-tuning is chosen

for its excellent frequency stability and spectral purity. The oscillators’ active elements (bipolar transistors in the 8683 and GaAs FET’s in the 8684) help attain the impressive residual FM and spurious response specifications of the generators. Refinements in both the electronic and mechanical designs stretch this performance over the broad frequency ranges.

Microprocessor Enhancements

A microprocessor has been incorporated into the design of these manually tuned generators. Many microwave component characteristics vary with frequency necessitating some form of compensation to ensure optimal accuracy. The microprocessor provides an effective and economical means for this compensation. It is responsible for the specified 1% frequency accuracy as well as the ± 2 dB output level accuracy.

The microprocessor also makes possible convenience features such as displaying output level in absolute dBm, dB relative to a user-selected power level, or with a specified Cable Offset. When Cable Offset is selected, the output level display indicates the power level at the end of a user-selected length of RG-214 cable rather than the level at the generator’s output connector.

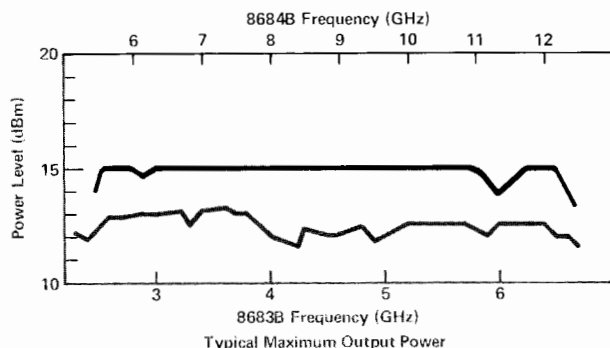

8683B, 8684B

These generators offer the advantage of extremely wide dynamic range coupled with excellent level accuracy. Output level ranges from –130 to +10 dBm. The versatility of the “B” models is expanded with the inclusion of six modulation modes, including internal and external AM, FM and pulse modulation. Low distortion coupled with display accuracy provides the AM and FM performance required for communications applications. The internal FM sawtooth with variable deviation is well suited for narrow-band swept measurements. Pulse performance is particularly noteworthy with modulation specifications of >80 dB on/off ratio, and rise/fall times <10 ns. The internal pulse generator offers pulse widths from 100 ms. to less than 100 ns., rates from 10 Hz to 1 MHz, and delays from 100 ms. to less than 50 ns. Pulsed-power is leveled to within 0.5 dB of the level set in CW mode. This performance level is especially important for modern radar system measurements.

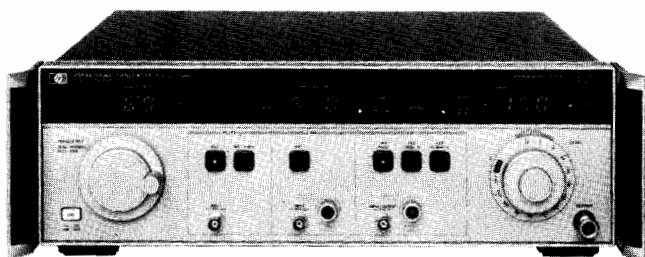

8683A



8683A, 8684A

These generators also offer impressive performance. Spectral purity and stability are identical to the "B" models. They provide 130 dB of dynamic range (-130 to 0 dBm) with ± 2 dB level accuracy. Their modulation section is well suited for communications applications with built-in, calibrated AM and FM capabilities. Limited external pulse modulation has been included, optimizing the value of the "A" model in communications systems.

Capabilities for Specific Microwave Measurements

The 8683 and 8684 were designed to meet the requirements of major microwave systems applications. In making out-of-channel communications receiver measurements, wide frequency range, low spurious, and a low noise floor are imperative. Receiver sensitivity measurements require excellent signal generator performance at low signal levels. These performance features are built into the 8683 and 8684. In addition, convenience features such as Cable Offset can significantly simplify the measurement of communication system parameters.

The features included in the "B" models provide the capability to handle advanced radar applications. With the addition of the high performance pulse modulator and internal pulse generator, simulation of a wide variety of radar transmissions is possible. Simultaneous FM and pulse allow chirping, while simultaneous AM and pulse allow simulation of antenna scan patterns. Of course, basic receiver sensitivity and AGC measurements can easily be made.

Reliability and Serviceability

The 8683 and 8684 were designed with reliability and serviceability as major considerations. The instruments were type tested to rigorous military specifications (MIL-T-28800 Class IV) for operating and non-operating temperature, humidity, condensation, shock and vibration, and EMI. The instruments' success in these tests is an indication of their ruggedness. Confidence that a desired output signal has been accurately generated is derived, in part, from a diagnostic test which is automatically executed on turn-on. These tests monitor most critical circuit nodes within the generator locating possible problem areas prior to the generator entering its operating mode. Reliability is further enhanced with optional low-cost reverse power protection.

Excellent serviceability results from the combination of accessibility to components, completeness of service manuals, and internal diagnostic capability. In the diagnostic mode, failures can be isolated to at least circuit function level with the aid of the front panel display or a computer terminal.

8683A/B, 8684A/B Specifications

(See technical data sheet for complete specifications.)

Frequency Characteristics

Frequency range: 8683, 2.3–6.5 GHz; 8684, 5.4–12.5 GHz.

Frequency resolution: 8683, 5 MHz using a 4 digit LED display; 8684, 10 MHz using a 3½ digit LED display.

Calibration accuracy: $\pm 1\%$.

Stability,

vs. time (20 min. after turn-on): < 30 kHz/min.

vs. time (60 min. after turn-on): < 100 kHz/hr.

vs. temperature: 8683, < 20 MHz; 8684, < 35 MHz from 0 to 55°C .

vs. line voltage (transients of $+5\%$ / -10%): < 30 ppm.

Spectral Purity

Harmonics (< 18 GHz, at specified maximum output): < -25 dBc.

Spurious (non-harmonically related): < 80 dBc. Typically, < -90 dBc.

Residual FM (50 Hz to 15 kHz post detection bandwidth): < 5 kHz peak.

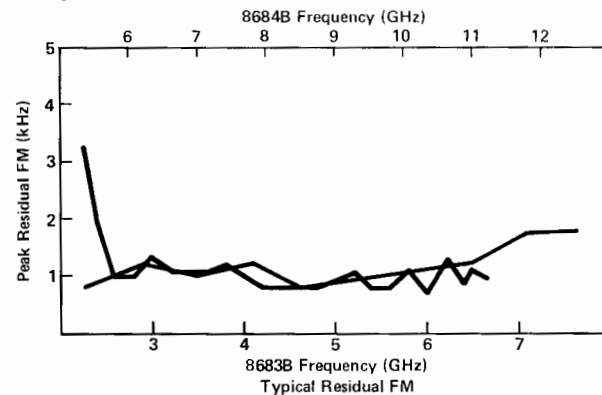

Single-sideband phase noise (avg. rms, 1 Hz BW, 10 kHz offset from carrier, typical): 8683, < -74 dBc; 8684, < -65 dBc.

Residual AM (avg. rms, 300 Hz to 15 kHz post detection bandwidth): < -65 dBc.

Output Characteristics

Level range (leveled into 50Ω): 8683/84A, 0 to -130 dBm; 8683/84A opt. 001 and 8683/84B, $+10$ to -130 dBm.

Resolution: 0.1 dB using a 3½ digit LED display.

Level Accuracy: ± 2.0 dB from maximum specified output to -110 dBm. ± 3.0 dB from -110 to -120 dBm. Option 002, reverse power protection, affects level accuracy $< \pm 0.5$ dB.

Level flatness (power level > -10 dBm): ± 1.0 dB.

Reverse power protection: The generators will typically accept 1 watt avg. or 100 watts peak power with no damage resulting. Option 002 increases this protection to approx. 10 watts avg. or 2 kilowatt peak.

Typical output impedance: 50Ω nominal. 8683 SWR < 2.0 ; 8684 SWR < 2.5 on $+10$ and 0 dBm ranges, < 2.0 for -10 dBm and below.

Auxiliary output: rear panel Type N output is typically > -15 dBm into 50Ω , being derived prior to AM or pulse modulation. Source impedance is approximately 50Ω .



8683A/B, 8684A/B Specifications (Cont.)

Modulation Characteristics

Types: Internal AM (1 kHz square wave)
Internal FM (1 kHz Sawtooth)
Internal Pulse (8683/84B only)
External AM; FM; Pulse
Simultaneous AM/FM, AM/Pulse, FM/Pulse, AM/FM/Pulse.

Metering: single 3-digit LED display. Selectable indication of AM depth or FM deviation.

Amplitude Modulation

AM specifications are valid for an output vernier range 5 to 15 dB below maximum vernier and for output levels at least 5 db below the specified maximum.

Depth: 0–70%.

AM rates (3 dB BW at 50% depth): dc to 10 kHz (dc coupled); 20 Hz to 10kHz (ac coupled).

AM distortion: <5% at 50% depth and 10 kHz rate.

Indicated AM accuracy: $\pm 5\%$ of full scale depths up to 50% at a 10 kHz rate.

Incidental FM (30% AM depth): <10 kHz peak to peak.

Internal AM: Fixed 1 kHz square wave with a duty cycle of $50 \pm 5\%$. Square wave on/off ratio is identical to that specified for pulse modulation.

Frequency Modulation

Peak deviation: ± 5 MHz.

FM rates: (3 dB BW): dc to 10 MHz (dc coupled), 50 Hz to 10 MHz (ac coupled).

FM distortion: <5% at 100 kHz rate and <1 MHz peak deviation.

Indicated FM accuracy: $\pm 20\%$ at a 100 kHz rate.

Incidental AM (rate <100 kHz, peak deviation <1 MHz): <5%.

Internal FM: FM sawtooth with a fixed sweep rate of 1 kHz and variable deviation up to specified maximum for external FM.

Phase lock input: rear panel BNC with typical sensitivity of -5 MHz/V. Input impedance is nominally > 1 k Ω .

Pulse Modulation

8683/84A External Pulse Input Requirements

Rate: 0 to 10 kHz.

Width: > 10 μ s.

On level: $> +3.0$ V peak.

Off level: $< +0.5$ V peak.

8683/84A RF Pulse Characteristics

Rise time: < 5 μ s.

Fall time: < 1 μ s.

On/off ratio (at maximum leveled power): > 30 dB.

8683/84B Internal pulse generator

Pulse repetition frequency: 10 Hz to 1 MHz in 5 ranges with continuous adjustment within ranges. Calibration accuracy is 20% of full scale.

Pulse width: 50 ns to 100 ms in 7 ranges with continuous adjustment within ranges. Calibration accuracy is 20% of full scale.

Pulse delay (time between sync out and video out): < 30 ns to 100 ms in 7 ranges with continuous adjustment within ranges. Calibration accuracy is 20% of full scale. The range for < 100 ns is uncalibrated.

Synchronizing Signals

Video out: > 3 V peak positive replica of the selected RF pulse, delayed no more than 50 ns in advance of the RF pulse.

Sync out: > 1 V peak positive pulse into 50 Ω with a nominal width of 20 ns. Sync out appears in advance of the RF pulse and video pulse according to the delay set with the pulse delay control.

External trigger: 0–1 MHz, dc coupled. On levels must be > 0.8 V positive polarity and held > 20 ns to affect trigger. Input impedance is approx. 50 Ω .

Pulse UNCAL indicator: Annunciator warns operator of improper setting of PRF, width, and delay controls.

8683/84B External Pulse Input Requirements

Rate: 0 to 1 MHz.

Width: > 100 ns.

On level: $> +3.0$ V peak.

Off level: $< +0.5$ V peak.

8683/84B RF Pulse Characteristics

Rise or fall time: < 10 ns.

On/off ratio: > 80 dB.

Ring and overshoot: $< 20\%$.

Minimum pulse width: < 100 ns.

Video feedthru: 25 mV max. (at 0 dB attenuation).

Maximum pulse repetition frequency: > 1 MHz.

Pulse width compression: < 50 ns.

Minimum duty cycle: 0.01% (may become unleveled below 0.01%).

Peak pulse power: ± 0.5 dB of level set in CW mode.

General

Operating temperature range: 0° to 55°C.

EMI: MIL-STD-461.

Environmental (operating and non-operating temperature, humidity, shock and vibration): type tested to MIL-T-28800B Class IV requirements.

Safety: meets the requirements of IEC 348.

Power: 100, 120, 220, or 240, +5%, -10% , for line frequencies of 48 to 66 Hz. Option 003 adds 400 Hz line frequency operation at 100 or 120 V. Power consumption is < 200 VA.

Weight:

Model	8683	8684
Net	<17.3 kg (38 lb)	<15.9 kg (35 lb)
Shipping	<22.8 kg (50 lb)	<21.4 kg (47 lb)

Dimensions: 145 H x 457 W x 472 mm D (5.7 x 18 x 18.6 in).

Ordering Information

	Price
8683A Microwave Signal Generator	\$12,000
8684A Microwave Signal Generator	\$12,000
8683B Microwave Signal Generator	\$15,000
8684B Microwave Signal Generator	\$15,000
Option 001: +10 dBm output power, 8683A, 8684A	add \$1,500
Option 002: Reverse power protection, 8683A/B	add \$100
Option 002: Reverse power protection, 8684A/B	add \$400
Option 003: 400 Hz line frequency operation	add \$180
Option 910: Extra operating and service manual	add \$25
Option 913: Rack mounting flange kit	add \$31

- 2-6.2 GHz frequency range
- 1 kHz frequency resolution
- $<5 \times 10^{-10}$ /day stability

- Low spurious and phase noise
- +8 dBm minimum output power
- HP-IB programmability

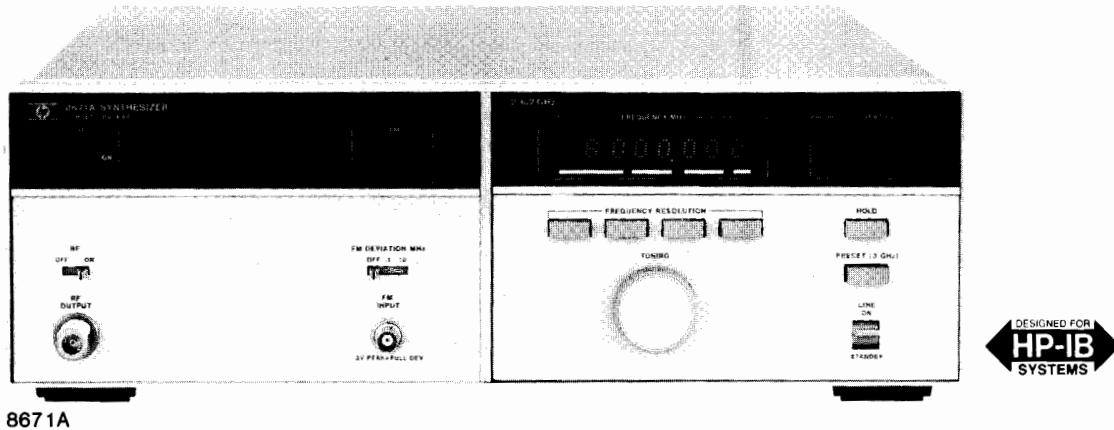

8671A Synthesizer

The 8671A microwave frequency synthesizer covers the frequency range of 2.0 to 6.2 GHz in 1 kHz steps with excellent stability and spectral purity. It is well suited for most LO applications that require state-of-the-art performance as well as broadband capability.

Spectral Purity

Spurious responses (except power line related) are greater than 70 dB below the carrier across the full frequency band. Phase noise, a critical parameter in many applications, is low enough to permit extremely sensitive measurements.

Output Power

The 8671A has a guaranteed output of +8 dBm at all frequencies. This is well within the operating range of most commercial mixers. However, for applications requiring greater power, the 8671A produces clean outputs as high as +10 dBm at many frequencies (see figure 1).

Wideband FM

The 8671A also has frequency modulation capability at rates up to 10 MHz and peak deviations up to 10 MHz (with externally applied signals). Carrier phase-lock is maintained in the FM mode.

HP-IB Programmability

The standard programming interface offered with the 8671A is directly compatible with the Hewlett-Packard Interface Bus. Programmable functions include frequency, FM, and RF ON/OFF.

8671A Specifications

(See technical data sheet for complete specifications.)

Frequency Characteristics

Frequency range: 2.0-6.2 GHz (6.199999 GHz).

Frequency resolution: 1 kHz.

Time base: internal 10 MHz ($<5 \times 10^{-10}$ /day aging rate) or external 5 or 10 MHz.

Switching time: <15 ms to be within 1 kHz.

Harmonics: <-15 dBc.

Single-sideband phase noise (1 Hz BW, CW mode):

	Offset from F_c				
	10 Hz	100 Hz	1 kHz	10 kHz	100 kHz
SSB level	-58 dBc	-70 dBc	-78 dBc	-86 dBc	-110 dBc

Spurious

Non-harmonically related: <-70 dBc.

Power line related (CW mode, and within 5 Hz below any line related frequency):

	Offset from F_c		
	<300 Hz	300 Hz to 1 kHz	>1 kHz
Power line spurious	-50 dBc	-60 dBc	-65 dBc

Output Characteristics

Power (unleveled): +8 dBm (min.), +15 to 35°C.

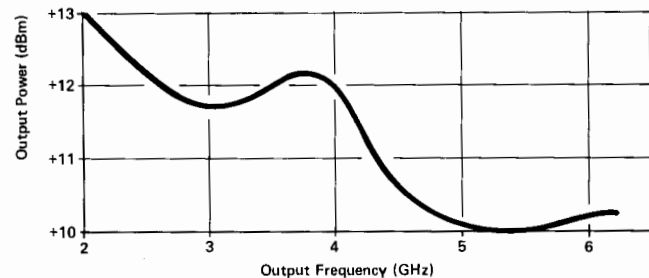

Figure 1. Typical output power available.

Flatness: <6 dB total variation across full frequency band.

Source impedance: 50Ω

Frequency Modulation

Peak deviation (max): 10 MHz or $f_{mod} \times 5$, whichever is smaller.

Sensitivity: 50 kHz/V and 5 MHz/V ranges; max input 2V peak.

Rates (3 dB BW): 50 Hz to 10 MHz typical.

Remote Programming

Frequency: programmable over full range with 1 kHz resolution.

FM modulation: OFF, 50 kHz/V, and 5 MHz/V ranges.

Other: RF ON/OFF.

Programming format: HP-IB (Hewlett-Packard Interface Bus).

General

Operating temperature range: 0 to +55°C.

Power: 100, 120, 220, or 240 V +5, -10%; 48-66 Hz; 300 VA max.

Weight: net, 24 kg (53 lb); shipping, 29.5 kg (65 lb).

Size: 133 H x 425 W x 603 mm D (5.25" x 16.75" x 23.75"). 1 MW x 5/4 H x 23 D System II Module. For cabinet accessories, see pages 714-719.

Ordering Information

8671A Microwave Frequency Synthesizer
(Note: HP-IB cable not supplied. See page 30.)

Price
\$19,700

Option 002: No internal reference	less \$550
Option 003: Operation at 400 Hz line	add \$250
Option 005: Rear panel RF output	add \$ 75
Option 006: Chassis slide kit	add \$ 45
Option 907: Front panel handle kit	add \$32
Option 908: Rack mounting flange kit	add \$25
Option 909: Front panel handle plus rack mounting flange kit	add \$55
Option 910: Extra operating and service manual	add \$30
11712A Support Kit	\$575

SIGNAL GENERATORS

Synthesized Signal Generator

Model 8672A

- 2 to 18 GHz frequency range
- 1 to 3 kHz frequency resolution
- Low spurious and phase noise
- +3 to -120 dBm calibrated output
- $<5 \times 10^{-10}$ /day stability
- Metered AM/FM

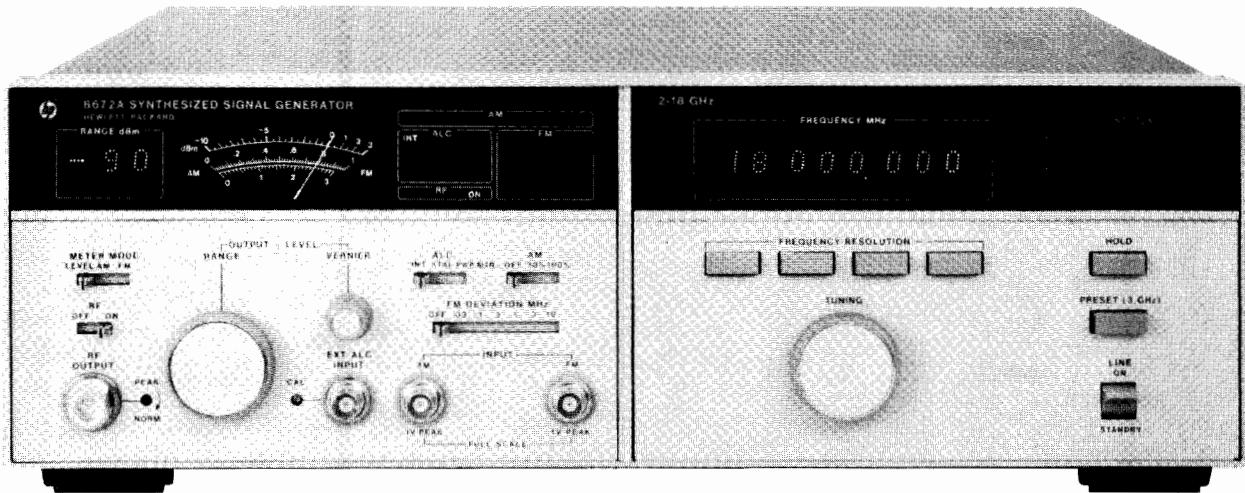

8672A



8672A Synthesized Signal Generator

The 8672A Synthesized Signal Generator covers the entire 2.0 to 18.0 GHz frequency range in one compact solid-state package (133 mm, 5.25 in. high) while providing calibrated output and complete AM/FM modulation capability. The 8672A can replace two, three, or even four instruments in many applications.

Advanced Thin Film Technology

An indirect synthesis technique is used to phase lock a wideband 2.0 to 6.2 GHz YIG-tuned transistor oscillator (YTO) to the internal (or external) time base. The output of the YTO drives a YIG-tuned multiplier (YTM), a product made possible by HP's advanced microcircuit technology, to attain the 2 to 18 GHz coverage. The YTM produces spectrally pure harmonics of the input frequency and selects the proper harmonic automatically.

Excellent Spectral Purity

The 8672A has been designed for very low single-sideband phase noise (see figure 2). This characteristic is very important for LO

applications and many tests on communication and radar systems. Non-harmonic spurious signals are also controlled to prevent undesired responses. Such signals are -70 dBc from 2 to 6.2 GHz, -64 dBc from 6.2 to 12.4 GHz and -60 dBc from 12.4 to 18 GHz, excluding power line related frequencies.

Wide Dynamic Output Range

For broadband component and receiver testing applications the 8672A exhibits an exceptionally flat frequency response across the full 2 to 18 GHz range. The calibrated 110 dB RF step attenuator on the output results in accurate output control from +3 to -120 dBm, enabling very sensitive receiver tests to be made. For LO applications, an "overrange" position provides additional power at most frequencies across the full 2 to 18 GHz band. Even more power is available from the 8672A Option 008, which provides a leveled +8 dBm from 2 to 18 GHz. Typical maximum unleveled output power from both the 8672A and 8672A Option 008 are shown in figure 1.

Calibrated AM/FM Modulation

To expand the versatility of the 8672A for accurate receiver testing, AM/FM capability is provided (with externally applied modulation signals). AM depth at rates up to 100 kHz can be accurately set using the front panel meter. FM is allowed at rates and peak deviations up to 10 MHz. The meter can also be used to monitor peak deviations on any of six selectable ranges. Both AM depth and FM deviation are linearly controlled by varying the input voltage up to 1 volt maximum. The 8672A remains phase locked in both the AM and FM modes.

All Functions Fully Programmable

The 8672A provides full programmability of all front-panel functions: frequency, output level (in 1 dB steps), and modulation selection. The 8672A has an HP-IB interface (standard on all units) and can be used with any HP 9800 series calculator or minicomputer for automatic systems application.

Fast Pulse Capability Available

High performance pulse modulation of the 8672A output is available via the 11720A Pulse Modulator (see page 419). This pulse modulator provides >80 dB on/off ratios with 5 nanosecond (typical) rise and fall times over the 2 to 18 GHz range of the 8672A.

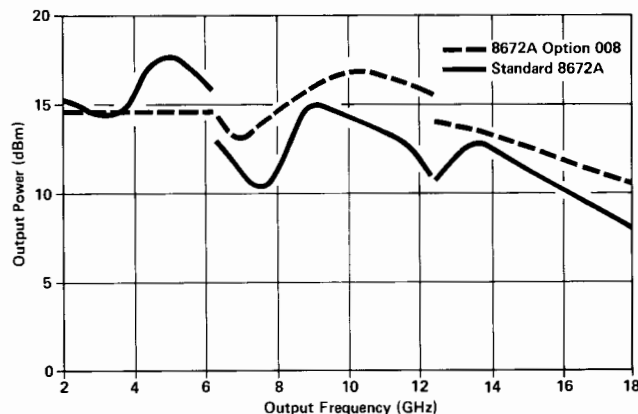

Figure 1. Maximum power typically available from standard and Option 008 instruments at 25°C.



8672A Specifications

(See technical data sheet for complete specifications)

Frequency Characteristics

Frequency range: 2.0–18.0 GHz (with overrange to 18.599997 GHz).

Frequency resolution: 1 kHz to 6.2 GHz, 2 kHz to 12.4 GHz, 3 kHz to 18.0 GHz.

Time base: internal 10 MHz ($<5 \times 10^{-10}$ /day aging rate) or external 5 or 10 MHz.

Frequency switching time: <15 ms to be within 1 kHz, 2–6.2 GHz; 2kHz, 6.2–12.4 GHz; 3 kHz, 12.4–18 GHz.

Spectral Purity

Harmonics, subharmonics and multiples (≤ 18 GHz): <-25 dBc.

Single-sideband phase noise (1 Hz BW, CW mode):

F_c	Offset from F_c				
	10Hz	100 Hz	1kHz	10kHz	100kHz
2.0-6.2 GHz	-58 dBc	-70 dBc	-78 dBc	-86 dBc	-110 dBc
6.2-12.4 GHz	-52 dBc	-64 dBc	-72 dBc	-80 dBc	-104 dBc
12.4-18.0 GHz	-48 dBc	-60 dBc	-68 dBc	-76 dBc	-100 dBc

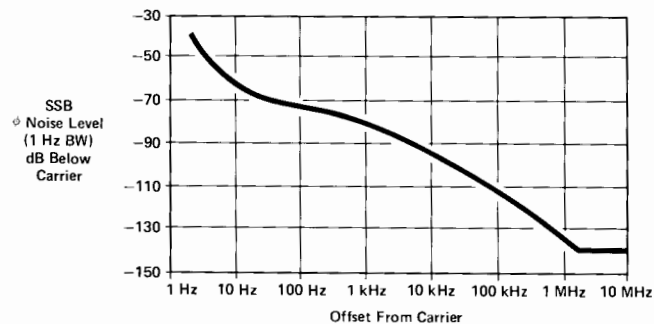

Figure 2. Typical 8672A single-sideband phase noise performance using the internal standard, 2.0-6.2 GHz.

Spurious (CW and AM modes)

Non-harmonically related:

<-70 dBc, 2.0-6.2 GHz.

<-64 dBc, 6.2-12.4 GHz.

<-60 dBc, 12.4-18.0 GHz.

Power line related (CW mode, and within 5 Hz below line frequency, and multiples):

F_c	Offset from F_c		
	<300 Hz	300 Hz to 1 kHz	>1 kHz
2.0-6.2 GHz	-50 dBc	-60 dBc	-65 dBc
6.2-12.4 GHz	-44 dBc	-54 dBc	-59 dBc
12.4-18.0 GHz	-40 dBc	-50 dBc	-55 dBc

Output Characteristics

Output level (+15°C to +35°C): +3 to -120 dBm.

Total indicated meter accuracy (+15°C to +35°C):

Frequency Range	Output Level Range			
	0 dBm	-10 dBm	-20 dBm	-30 dBm and below
2.0-6.2 GHz	± 1.75 dB	± 2.25 dB	± 2.45 dB	± 1.75 dB ± 0.3 dB/10 dB step below 0 dBm range
6.2-12.4 GHz	± 2.0 dB	± 2.5 dB	± 2.7 dB	± 2.0 dB ± 0.3 dB/10 dB step below 0 dBm range
12.4-18.0 GHz	± 2.25 dB	± 2.85 dB	± 3.05 dB	± 2.25 dB ± 0.4 dB/10 dB step below 0 dBm range

Remote programming accuracy: 0.75 dB better than indicated meter accuracy.

Flatness (+15°C to +35°C): ± 0.75 dB, 2.0-6.2 GHz; ± 1.00 dB, 2.0-12.4 GHz; ± 1.25 dB, 2.0-18.0 GHz.

Output level switching time: <20 ms.

Source impedance: 50 Ω .

Amplitude Modulation

AM depth (for RF output meter readings ≤ 0 dB, +15°C to +35°C):

0-75%, 2.0-6.2 GHz; 0-60%, 6.2-12.4 GHz; 0-50%, 12.4-18.0 GHz.

Sensitivity: 30%/V, 100%/V ranges. Max. input 1 V peak into 600 Ω .

Rates (3 dB BW): 10 Hz-100 kHz.

Indicated AM meter accuracy (100 Hz – 10 kHz rates): $\pm 5\%$ of range.

Distortion (rates ≤ 10 kHz, RF output ≤ 0 dB, +15°C to +35°C): $<3\%$ at 30% depth.

Frequency Modulation

Peak deviation (max.): the smaller of

10 MHz or $f_{mod} \times 5$, 2.0–6.2 GHz.

10 MHz or $f_{mod} \times 10$, 6.2–12.4 GHz.

10 MHz or $f_{mod} \times 15$, 12.4–18.0 GHz.

Sensitivity: 30, 100, 300 kHz/V and 1, 3, 10 MHz/V ranges; max. input 1 volt peak into 50 Ω .

Rates (3 dB BW typical): 30, 100 kHz/V ranges: 50 Hz to 10 MHz; 300 kHz/V and 1, 3, 10 MHz/V ranges: 1 kHz to 10 MHz.

Distortion: $<12\%$ for rates <3 kHz decreasing linearly with frequency to 5% at 20 kHz; $<5\%$ for 20 kHz to 100 kHz rates.

Indicated FM meter accuracy (100 kHz rate, +15°C to 35°C): $\pm 10\%$ of full scale.

Residual FM in FM and CW modes, 2-6.2 GHz:

Range	Post Detection BW	
	20 Hz–1 kHz ¹	20 Hz–3kHz ¹
CW, 30, 100, 300 kHz/V; and 1, 3, 10 MHz/V	6 Hz rms	12 Hz rms
10MHz/V	10 Hz rms	20 Hz rms

¹Residual FM doubles for 6.2-12.4 GHz, triples for 12.4-18 GHz

Remote Programming Capability

Frequency: programmable over full range with same resolution as in manual mode.

Output level: programmable over full range in 1 dB steps.

AM modulation: OFF, 30%/V, and 100%/V ranges.

FM modulation: OFF, 30, 100, 300 kHz/V and 1, 3, 10 MHz/V ranges.

Other: RF ON/OFF, ALC INT./EXT. (crystal or power meter).

Programming format: HP-IB (Hewlett-Packard Interface Bus).

General

Operating temperature range: 0 to +55°C.

Power: 100, 120, 220, 240 V +5, -10%; 48-66 Hz; 300 VA max.

Weight: net, 27 kg (60 lb); shipping, 32.5 kg (72 lb).

Size: 133 mm H x 425 mm W x 603 mm D (5.25" x 16.75" x 23.75"). 1 MW x 5 1/4 H x 23 D System II Module. For cabinet accessories, see pages 714-719.

Ordering Information

8672A Synthesized Signal Generator

Price

\$34,500

(Note: HP-IB cable not supplied. See page 30.)

Option 001: No RF output attenuator less \$600

Option 002: No internal reference oscillator less \$550

Option 003: Operation at 400 Hz line add \$250

Option 004: Rear panel RF output add \$ 75

Option 005: Rear panel RF output without RF attenuator less \$525

Option 006: Chassis slide kit add \$ 45

Option 008: +8 dBm output level add \$3500

Option 907: Front panel handle kit add \$32

Option 908: Rack mounting flange kit add \$25

Option 909: Front panel handle kit plus rack mounting flange kit add \$55

Option 910: Extra operating and service manual add \$25

11712A Support Kit \$575

SIGNAL GENERATORS

PIN Modulators, Pulse Driver

8730 Series, 8403A

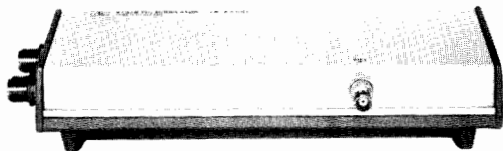

8730B Series

8730 Series PIN Modulators

With HP 8730 series PIN Modulators, signal sources, including klystrons, can be pulse-modulated, leveled or amplitude-modulated with sinusoidal and complex waveforms. Fast-rise times, low incidental FM and a nearly constant impedance match to source and load are typical of these absorption-type modulators.

8403A Modulator

The Model 8403A provides complete control of the PIN modulators, supplying the appropriate modulation wave shapes and bias levels for fast rise times, rated on/off ratios and amplitude modulation. An internal square-wave and pulse modulator with PRF of 50 Hz to 50 kHz and adjustable pulse width and delay also provide square wave and pulses for general pulse applications. For applications requiring an absorption-type modulator plus controls in a single unit, a PIN modulator can be installed in the Model 8403A.

8403A Specifications

Output characteristics (available separately at front panel).

For driving 8730 PIN modulators: AM and pulse output, pulse output specially shaped for optimum RF rise and decay times.

For general pulse applications: positive dc-coupled pulse 25 to 30 volt in amplitude, approximately symmetrical about 0 volt; no AM signal.

Modulation

Internal square wave

Frequency: variable from 50 Hz to 50 kHz.

Symmetry: better than 45/55%.

Internal pulse

Repetition rate: variable from 50 Hz to 50 kHz.

Delay: variable from 0.1 μ s to 100 μ s, between sync out pulse and RF output pulse.

Width: variable from 0.1 μ s to 100 μ s.

External sync

Signal: 5 to 20 volts peak, + or -, pulse or sine wave.

Input impedance: approximately 2000 ohms, dc-coupled.

8730 Series Specifications

HP Model	8731A	8731B	8732A	8732B	8733A	8733B	8734A	8734B	8735A	8735B	8731B-H10*
Frequency range (GHz)	0.8-2.4	0.8-2.4	1.8-4.5	1.8-4.5	3.7-8.3	3.7-8.3	7.0-12.4	7.0-12.4	8.2-12.4	8.2-12.4	0.4-1.2
Dynamic range (dB)	35	80	35	80	35	80	35	80	35	80	35
Max. residual atten. (dB) ¹	<1.5	<2.0	<2.0	<3.5 ²	<2.0	<3.0	<4.0	<5.0	<4.0	<5.0	<2.0
Typical rise time (ns) ³	40	30	40	30	30	30	30	30	30	30	40
Typical decay time (ns) ³	30	20	30	20	20	20	20	20	20	20	30
SWR, min. attenuation	1.5	1.6	1.5	1.6 ⁴	1.8	2.0	1.8	2.0	1.7	2.0	1.5 ⁷
SWR, max. attenuation	1.8	2.0	1.8	2.0	2.0	2.2	2.0	2.2	2.0	2.2	2.0 ⁷
Forward bias input resistance (ohms)	300	100	300	100	300	100	300	100	300	100	300
RF connector type	N(f)	N(f)	N(f)	N(f)	N(f)	N(f)	N(f)	N(f)	W/G ⁵	W/G ⁵	N(f)
Weight, net kg (lb)	1.4 (3.0)	2.5 (5.5)	1.4 (3.0)	2.7 (6.0)	1.0 (2.1)	1.4 (3.0)	1.3 (2.8)	1.4 (3.0)	1.4 (3.0)	1.4 (3.0)	2.5 (5.5)
shipping kg (lb)	1.9 (4.2)	3.3 (7.3)	1.9 (4.2)	3.5 (7.8)	1.4 (3.2)	1.9 (4.2)	1.8 (3.9)	1.9 (4.2)	1.9 (4.1)	1.9 (4.2)	3.3 (7.3)
Dimensions											
Height, mm (in)	57 (2.25)	57 (2.25)	57 (2.25)	57 (2.25)	57 (2.25)	57 (2.25)	57 (2.25)	57 (2.25)	57 (2.25)	57 (2.25)	57 (2.25)
Width, mm (in)	83 (3.25)	124 (4.9)	83 (3.25)	124 (4.9)	83 (3.25)	83 (3.25)	83 (3.25)	83 (3.25)	83 (3.25)	83 (3.25)	124 (4.9)
Depth, mm (in)	283 (11.1)	289 (11.4)	283 (11.1)	289 (11.4)	213 (8.4)	311 (12.3)	213 (8.4)	311 (12.3)	171 (6.75)	267 (10.5)	289 (11.4)
Prices	\$840	\$1200	\$840	\$1300	\$900	\$1350	\$950	\$1350	\$950	\$1350	\$1200

Maximum ratings: maximum input power, peak or CW: 1 W; bias limits: +20 V, -10 V.

Bias polarity: negative voltage increases attenuation.

RFI: radiated leakage limits are below those specified in MIL-I-6181D at input levels <1 mW; at all input levels radiated interference is sufficiently low to obtain rated attenuation.

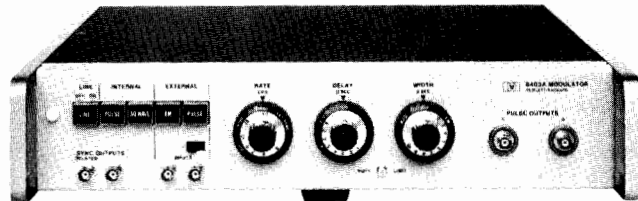

8403A

Trigger out

Sync out: simultaneous with or 0.1 to 100 μ s in advance of RF pulse, as set by delay control.

Delayed sync out: simultaneous with output pulse.

Amplitude: approximately -2 volts.

Source impedance: approximately 330 ohms.

External Pulse

Amplitude and polarity: 5 volts to 20 volts peak, + or -.

Repetition rate: maximum average PRF, 500 kHz/s.

Input impedance: approximately 2000 ohms, dc-coupled.

Width: minimum 0.1 μ s; maximum 1/PRF -0.4 μ s.

Amplitude Modulation (with 8730 series)

Frequency response: dc to approximately 10 MHz (3 dB).

Sensitivity: approximately 10 dB/volt with HP 8730A series; approximately 20 dB/volt with HP 8730B series.

Input impedance: approximately 1000 ohms.

General

Power: 115 or 230 volts \pm 10%, 50 to 400 Hz, approximately 10 watts.

Size: 96 H x 425 W x 467 mm D (3.75" x 16.73" x 18.4").

Weight: net, 7.4 kg (16.5 lb); shipping, 9 kg (20 lb).

Ordering Information

8403A Modulator

Price

\$1900

Option

001: 8731A PIN Modulator installed in 8403A	add \$890
002: 8731B PIN Modulator installed in 8403A	add \$1250
003: 8732A PIN Modulator installed in 8403A	add \$890
004: 8732B PIN Modulator installed in 8403A	add \$1350
005: 8733A PIN Modulator installed in 8403A	add \$950
006: 8733B PIN Modulator installed in 8403A	add \$1480
007: 8734A PIN Modulator installed in 8403A	add \$1050
008: 8734B PIN Modulator installed in 8403A	add \$1400
009: Input and Output Connectors on rear panel	add \$50
908: Rack flange kit	add \$25.00
910: Extra Manual	add \$7.50

- 2 to 18 GHz
- < 10 ns rise and fall times
- > 80 dB ON/OFF ratio

- Extends frequency range down to 10 kHz on all 8640 and 8654 series generators
- Preserves calibrated output level and modulation

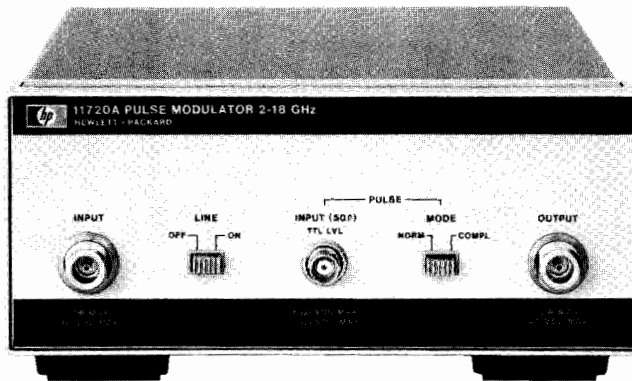

11720A

11720A Pulse Modulator

The 11720A Pulse Modulator is a high performance microwave pulse modulator covering the range of 2 to 18 GHz. Because of this wide frequency coverage, it can be used to increase the modulation capabilities of many microwave sources (sweepers or signal generators) and eliminate the need for several individual modulators in broadband applications.

In addition to wide frequency coverage, the 11720A features extremely short rise and fall times (<10 ns) and a high on/off ratio (>80 dB), making it suitable for almost any pulsed RF application.

The modulator used in the 11720A is a unique series-shunt PIN diode switch offering superior performance to that of a simple shunt-diode switch which reflects the input power back to the source in the "off" state. In the 11720A the series components reduce this reflection without significantly increasing the insertion loss.

The 11720A contains all the necessary modulator drive circuitry to achieve specified performance so that a standard pulse generator, or any other source that can deliver >3 V peak into 50 ohms, can supply the input. In addition, a normal/complement function is provided to adapt the 11720A to positive-true or negative-true logic inputs.

11720A Specifications

Frequency range: 2 to 18 GHz.

ON/OFF ratio: >80 dB.

Rise and fall times: <10 ns.

Insertion loss: <6 dB, 2 to 12.4 GHz; <10 dB, 2 to 18 GHz.

Maximum RF input power: +20 dBm.

Maximum repetition rate: >5 MHz.

Minimum RF pulse width: <50 ns.

Video feedthrough: <60 mV peak-to-peak.

Pulse Input

Normal mode: >3 V (on), <0.5 V (off).

Complement mode: <0.5 V (on), >3 V (off).

Impedance: 50 Ω nominal.

Operating temperature: 0°C to +55°C.

Power: 100, 120, 220, 240 V +5, -10%; 48-400 Hz; 25 VA max.

Weight: net, 2.6 kg (5 lb 12 oz); shipping, 3.6 kg (8 lb).

Size: 101 mm H x 212 mm W x 290 mm D (4.0" x 8.4" x 11.4"). ½ MW x 3½ H x 11 D System II Module. For cabinet accessories, see pages 714-719.

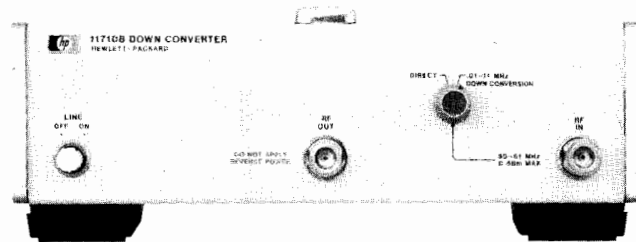

11710B

11710B Down Converter

The 11710B Down Converter is an accessory for the 8640 and 8654 series signal generators. Frequency inputs from 50.01 to 61 MHz are down converted to the 10 kHz to 11 MHz range respectively. The output level and modulation functions of the 8640 and 8654 remain calibrated. A straight-through selection switch allows the input to pass through unchanged and thus minimizes the necessity to move cables when testing. Option 001 provides rails and semi-rigid coax for combining the 11710B with an 8654A, B Signal Generator.

11710B Specifications

Input

Down-conversion mode: 50.01 to 61.00 MHz at ≤0 dBm.

Straight-through mode: 0.01 to 1100 MHz (dc coupled).

Down-converted Output

Frequency range: 10 kHz to 11 MHz.

Level range: 0 to -107 dBm.

Level flatness: RF source flatness ±0.5 dB (referred to 4.0 MHz).

Total level accuracy: ± (1 dB plus input level accuracy).

Harmonics: >35 dB below the carrier (dBc).

Intermixing spurious: >60 dBc.

Local oscillator feed-through (50 MHz): <-100 dBm.

Internal Reference Characteristics

Time base output: 1 MHz or 5 MHz selectable, nominally > 0.5 V p-p into 500Ω. This will drive an 8640B external time base input.

Typical overall accuracy: within 3 months of calibration and from 15°C to 35°C: ± 2 ppm.

General

Operating temperature range: 0 to 55°C.

Power requirements: 100, 120, 220, 240 V (+5%, -10%), 48 to 440 Hz; 25 VA maximum.

Weight: net, 3.2 kg (7 lb); shipping, 4.5 kg (9 lb).

Size: 102 H x 266 W x 295 mm D (4" x 10.5" x 11.6"). ½ MW x 4 H x 11 D System I Module.

Ordering Information

11720A Pulse Modulator

Option 910: Extra manual

11710B Down Converter

Option 001: Combining Kit

Option 910: Extra operating & service manual

Price

\$2800.00

add \$5.00

\$1500.00

add \$100.00

add \$3.50

SIGNAL GENERATORS

Accessories, Frequency Doublers

Models 10514A, 10534A, 11509A, 11687A, 11690A, 11697A,B,C, 11721A

- Additional capabilities for signal generators

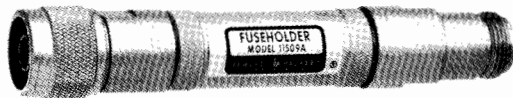

11509A



11687A

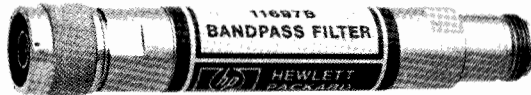

11697B

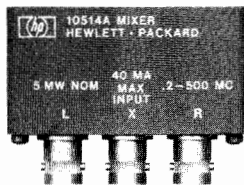

10514A

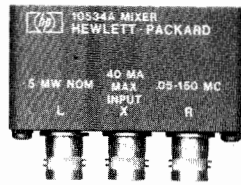

10534A

10514A, 10534A Double Balanced Mixers

These mixers are excellent in a variety of mixing applications as well as AM, pulse, and square-wave modulation applications. The careful balancing of the hot carrier diodes in the 10514A and 10534A provides excellent output suppression of the local oscillator and input frequencies. Frequency ranges are 0.2-500 MHz for the 10514A and 0.05-150 MHz for the 10534A. Connectors are BNC.

11509A Fuseholder

Accidental burnout of attenuators in HP 8640 and 8654 Signal Generators can be prevented by using this fuse element between the signal generator and a transceiver. The fuseholder has a frequency range of dc to 480 MHz, insertion loss of ≤ 1 dB, SWR of ≤ 1.35 (50 Ω load), and Type N connectors. Ten extra fuses are furnished.

11687A 50-75 Ω Adapter

This 50-75 Ω Adapter with Type N connectors is recommended for use with HP 8640, 8654, 8660, 8656, and 8662 Signal Generators for measurements in 75 Ω systems. The voltage calibration on the output level meter is unaffected by use of the adapter, but 1.76 dB must be subtracted from the dB scale on the meter to determine the output in dBm into 75 Ω . Frequency range is dc to 1300 MHz.

11697A, B, C Bandpass Filters

These filters reduce any harmonic and subharmonic-related spurious signals present in the output of doubled signal sources (such as the HP 8640 Signal Generator with Option 002 Internal Doubler or 11690A external Frequency Doubler). The 11697A and 11697B cover the USA UHF television band and the 11697C covers the range used for navigation aids and mobile radio. Midband attenuation is ≤ 0.6 dB, pass band attenuation is ≤ 1.1 dB, and pass band SWR is ≤ 1.4 . Connectors are Type N.

Rejection band attenuation:

Model	Below Passband		Above Passband	
	Frequency (MHz)	Attenuation	Frequency (MHz)	Attenuation
11697A	≤ 337	≥ 20 dB	768-3000	≥ 20 dB
11697B	≤ 445	≥ 20 dB	1011-3000	≥ 20 dB
11697C	≤ 550	≥ 20 dB	1333-3000	≥ 20 dB

- Increased signal generator frequency range



11690A

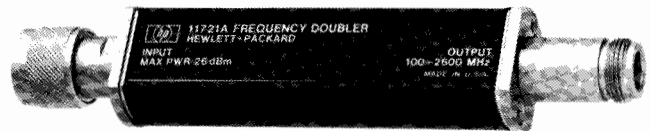

11721A

11690A Frequency Doubler

The 11690A extends the frequency range of all HP 8640 series Signal Generators by doubling the 256-512 MHz frequency band up to 1024 MHz (to 110 MHz with band overrange). All 8640's indicate the correct doubled output frequency on a dial or counter when the 512-1024 MHz range is selected. The 11690A will also perform well with any source meeting the input requirements of 200-550 MHz at +10 to +19 dBm. Conversion loss is < 13 dB, output flatness has < 4 dB total variation, and the 1st and 3rd input harmonics are suppressed > 20 dB. Connectors are BNC.

11721A Frequency Doubler

The 11721A Doubler is an ideal accessory for extending the useable frequency range of signal generators, frequency synthesizers, or other signal sources. Operating on input frequencies of 50 MHz to 1300 MHz, it provides a doubled output in the range of 100 MHz to 2600 MHz. The 11721A will work well with any RF source with an output in the range 50 to 1300 MHz.

The 50 Ω passive circuit of the 11721A offers low conversion loss, low spurious, and excellent flatness over its entire frequency range when operated above +10 dBm.

11721A Specifications

Input frequency range: 50 to 1300 MHz.

Output frequency range: 100 to 2600 MHz.

Conversion loss (+13 dBm input, 50 to 1280 MHz): < 15 dB.

Spurious referenced to desired output frequency f (+13 dBm input with harmonics < -50 dBc, 50 to 1280 MHz): $f/2$, -15 dB; $3f/2$, -15 dB.

Input SWR: 1.5 typical.

Input/output impedance: 50 Ω nominal.

Operating temperature range: 0 to +50°C.

Connectors: input, type N male; output, type N female.

Size: 161 L x 30 W x 20.5 mm H (6 $\frac{3}{8}$ " x 1 $\frac{1}{8}$ " x 1 $\frac{1}{8}$ ").

Weight: net, 181 g (6.4 oz); shipping, 335 g (11.8 oz).

Ordering Information

11514A Double Balanced Mixer (0.2-500 MHz)

10534A Double Balanced Mixer (0.05-150 MHz)

10509A Fuseholder

11687A 50 Ω -75 Ω Adapter

11690A Frequency Doubler

11697A Bandpass Filter (512-674 MHz)

11697B Bandpass Filter (674-890 MHz)

11697C Bandpass Filter (800-1100 MHz)

11721A Frequency Doubler

Price

\$155

\$116

\$100

\$150

\$180

\$325

\$325

\$325

\$350

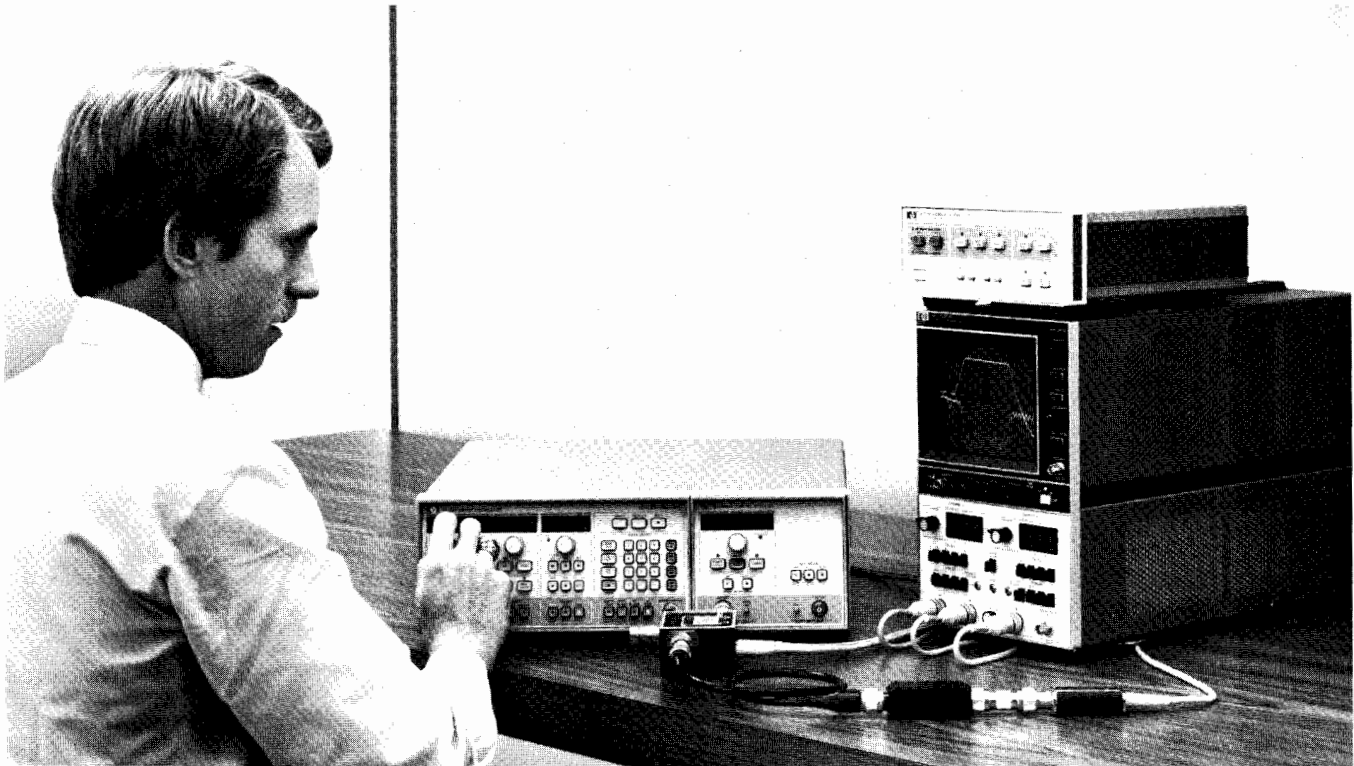

Sweep Oscillators

Swept frequency oscillators are used in applications where the characteristics of a device must be determined over a wide, continuous range of frequencies. Combined with a broadband detector and display test set, sweep oscillators provide many benefits compared to CW frequency sources. A swept measurement provides a dynamic display of the data. The results of any adjustments to the unknown test device are seen immediately (real time) on the display. By replacing laborious point-by-point techniques swept measurements increase the speed and convenience of broadband testing. The continuous frequency characterization of the unknown device also eliminates the chance of missing important information between frequency points. Swept techniques are applicable in all phases of design, manufacture and maintenance.

Hewlett-Packard Sweep Oscillators

Hewlett-Packard sweepers cover the entire frequency spectrum from dc to 50 GHz. Self-contained, multi-octave sweepers cover the frequency range to 110 MHz. The 8690 series of backward wave and solid state oscillators features plug-ins from 400 kHz to 50 GHz. The 8620 family of solid state oscillators provide a versatile choice of configurations—single band, straddle band, or very wide band plug-ins from 10 MHz to 22 GHz. 10 MHz to 26.5 GHz coverage is available in the new 8350 family of plug-in sweep oscillators. A chart of the individual frequency bands available appears on page 405.

Sweep Oscillator Features

Sweep Flexibility

Every HP sweeper has several different sweep modes available for setting the fre-

quency limits of the instrument. A full band or independently adjustable start/stop frequency sweep can be selected. Alternatively, a marker sweep or a symmetrical ΔF sweep about the desired center frequency can be chosen. Switching from one sweep mode to another is a simple pushbutton operation. In the auto mode the sweep retriggers automatically. Sweep times from 0.01 to more than 100 seconds can be selected. A manual sweep is also available as a front panel control, a real convenience for calibrating displays such as X-Y recorders. An external trigger is provided as well for applications where the sweeper must be synchronized to other instrumentation or remotely controlled.

On all sweeps a linear voltage proportional to frequency is available on an external connector which is useful for driving the horizontal of a display. Blanking and pen lift signals are also provided at rear output connectors during flyback time when the RF is off.

Marker capability, both Z-axis intensity dots and RF pips, are available on HP sweepers to note your important measurement frequencies. Two or more independent markers are offered on all sweepers with up to five markers on the new 8350A mainframe. Crystal markers are offered on the 86222B and 83522A 10 MHz to 2.4 GHz RF plug-ins, and the 83525A 10MHz to 8.4 GHz plug-in.

Another powerful feature available on the new 8350A sweeper mainframe is Save/Recall Mode. With Save/Recall Mode up to nine complete front panel states can be stored in memory and later recalled when the measurement is repeated. This saves considerable time when repetitive tests are required.

Power output and leveling

Power output is continuously adjustable at the front panel over approximately a 10 dB range of all plug-ins. Built-in attenuators are also available on most plug-ins for greater power control. Internal or external leveling is employed to obtain (1) a constant power output and (2) a good source match (low VSWR). This ensures high accuracy when making swept measurements.

The new 83500 series of plug-ins offer calibrated output power and internal leveling as standard features. Power is calibrated over a 15 dB range with 0.1 dB resolution (programmable to 0.02 dB); with Option 002, internal step attenuator, the calibrated range is extended to 85 dB.

Power as well as frequency can be swept using the 8350A and 83500 series plug-ins. This means that both the frequency response and power response of level sensitive devices like transistors and amplifiers can be measured using the same test setup. Using the Power Sweep function 1 dB gain compression can easily be measured at a CW frequency (Figure 1). Also, the ability to alternate between two discreet power levels on successive sweeps (8350A and 83500 series plug-

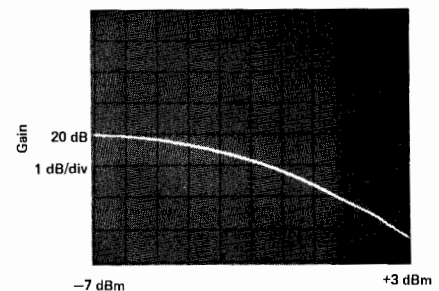



SWEEP OSCILLATORS

General Information

ins) allows a swept measurement of 1 dB compression point. Output power characteristics can be optimized simultaneously (Figure 2).

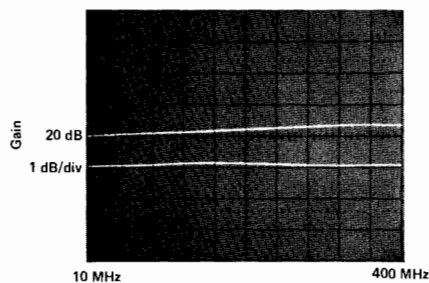

Figure 2.

Modulation

Modulation capabilities further extend the sweeper's usefulness both as a sweeper and a signal generator for signal simulations. Wide AM and FM bandwidths are useful for a variety of tests on communication receivers. The flexible FM capability allows remote analog frequency programming which is important for many applications.

External pulse modulation is also available on many plug-ins. Most plug-ins also accept the 27.8 kHz square wave modulation required by the HP8755C Frequency Response Test Set directly, eliminating the need for an external modulator. The 8350A mainframe will even supply the 27.8 kHz square wave modulation directly to the plug-in.

MLA Compatibility

In communications applications where up-converter simulation is required in conjunction with the HP Microwave Link Analyzer, the 86200 series of plug-ins provides this capability as an option in frequency ranges from 500 MHz to 18 GHz. Group delay of less than 1 nanosecond and linearity of better than 0.5% across 30 MHz across most of the frequency range permit very accurate RF to RF, RF to IF and RF to BB distortion measurements. See page 607 for more information.

Programming

The 8350A mainframe and 83500 series plug-ins are the first sweep oscillator system to offer total HP-IB control of all front panel functions. Not only CW frequencies, but sweeps, markers, power levels, etc., can be remotely programmed via the HP-IB. This means there are no limitations to designing customized automatic systems for either component or system testing.

The 8620C solid state sweeper mainframe provides optional BCD or HP-IB programming capability. More than ten thousand frequency points per band permit very fine frequency control. In addition, band selection, sweep mode, RF attenuator, and remote-local can be controlled remotely. This allows the sweeper to be used in a wide variety of automatic systems and sophisticated signal simulation applications.

For example, a 1 MHz to 18.6 GHz frequency synthesizer can be configured using a controller, the 86290B/8620C 2-18.6 GHz Sweep Oscillator, and the 8660 UHF Synthesizer. (See Figure 3). Harmonics of the

8660 are used to phase lock the sweeper to the accuracy and stability of the synthesizer. The desktop computer is then used to control the sweeper, the UHF synthesizer, and RF switches to allow keyboard selection of a CW signal or to step the source across a band of interest.

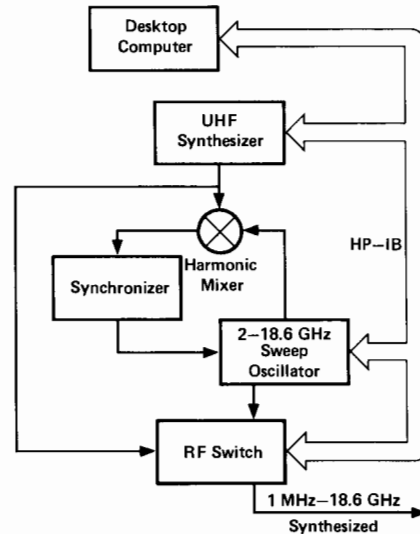

Figure 3.

In addition to controlling sweeper frequency, a computer can be used to assimilate data from a frequency response test set (HP-8755C) or network analyzer (HP8410B). With systems such as the one in Figure 4 the

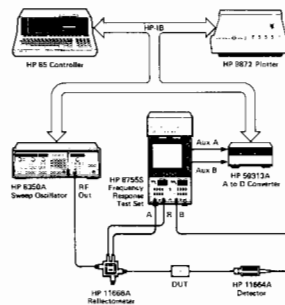

Figure 4.

computer can completely set up the measurement, sweep width, markers, power level, etc., and then document the measurement results in a printed or plotted format. For operations requiring a minimum of user interactions specification comparisons can be made for automatic "go no-go" testing. Us-

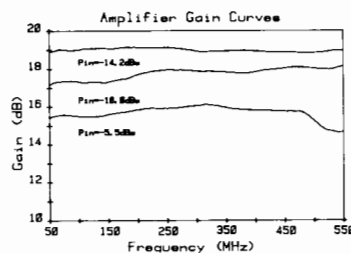

Figure 5.

ing the programmable power capability of the 83500 series plug-ins, automatic power as well as frequency response testing is possible (see figure 5).

Digital Sweeping Synthesizers

The 3325A, 3330B, 3335A, 8660C, and 8662A combine the precision frequency accuracy and stability of a synthesizer with the time saving convenience of a sweeper. Parameters such as start/stop/center frequencies, sweep width, frequency step and sweep time are entered and executed through a convenient keyboard or remote programming. Some additional features are phase continuous linear/log sweep in the 3325A and amplitude sweeping in steps as small as 0.01 dB in the 3330B. This in conjunction with frequency sweeping can provide a comprehensive family of curves.

Sweeper Applications

Sweepers are used extensively with swept frequency test sets to characterize the amplitude response of broadband devices or with network analyzers when the phase characteristics of the device (or S-parameters) are also needed. Two measurements—transmission and reflection—are basic to both types of analyzer. Hewlett-Packard offers a complete line of directional couplers, power splitters, and other transducers which together with the analyzers and sweep oscillators provide a total swept measurement solution.

The HP8755C Frequency Response Test Set operates over the 10 MHz to 26.5 GHz frequency range (operation at higher frequencies can be achieved using the HP 11664C Detector Adapters). It is a two channel diode detection receiver system with -50 dBm sensitivity and ratio capability. Combined with the 8350A and broadband plug-ins like the 83592A (.01 - 20 GHz) it is ideal for simultaneous magnitude-only transmission and reflection measurements. Convenience is enhanced since the 8350A provides the required 27.8 kHz modulation directly. With the 8755C alternate sweep testing is possible, since Channel 1 is only permitted to respond to the 8350A's current state while channel 2 responds to the alternate state. This allows "simultaneous" measurements of both filter skirt and passband responses (see Figure 6).

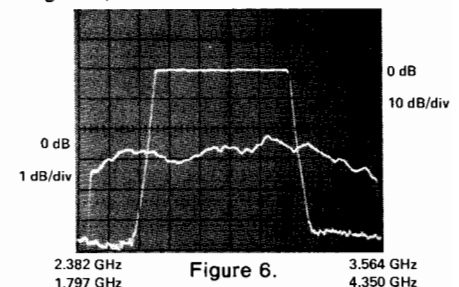

Figure 6.

For measurements requiring more sensitivity and/or phase information, sweepers may be used with network analyzers. These measurements can easily be made across many octaves of frequency. For example, with the 83522A or 86222A/B RF Plug-ins and the 8410B Network Analyzer, phase-magnitude transmission or reflection coefficients can be measured across the full, 0.11-2.4 GHz

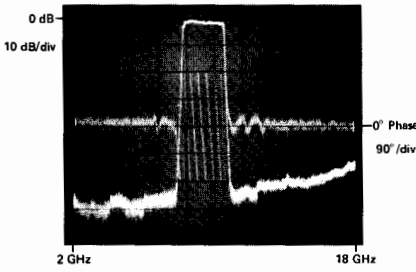

Figure 7

Figure 7 is a CRT photo of simultaneous phase and magnitude transmission characteristics of an 8 to 10 GHz using the 86290B Sweep Oscillator Plus-in.

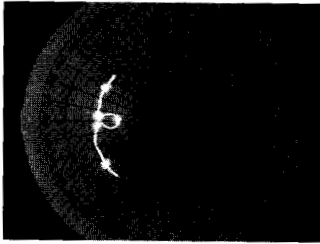

Figure 8

range in one continuous sweep. Since the 8410B is a tuned receiver there is a spurious-free sensitivity of -78 dBm.

Figure 8 shows an 8414A Polar Display with all five 8350A markers used to note critical frequencies.

For high power applications such as RFI-susceptibility tests and high attenuation measurements, Hewlett-Packard offers TWT amplifiers which provide better than 1 watt from 1 to 18 GHz.

Synthesizer accuracy and stability can be obtained by phase-locking the Hewlett-Packard sweep oscillators to a harmonic of a very stable source. This high stability is important in many applications including microwave spectroscopy and high-Q swept frequency measurements.

Two-tone sweep testing of devices such as mixers and receiver front ends requires two signals offset from each other by the IF. This is accomplished by phase-locking the difference frequency of two sweep oscillators to a very stable source. The sweepers may then be swept across the band of interest.

The modulation and built-in attenuator features of Hewlett-Packard sweep oscillators make them useful in many traditional CW signal generator applications. In addition, accuracy, linearity, and flatness of the broadband plug-ins like the 83590A,

83594A, 83595A, 83592A, 86290A/B/C, 83525A, 86222A/B, and 83522A make them more than adequate in many applications requiring a general purpose CW generator.

For wideband applications these RF plug-ins feature performance that rivals octave band oscillators in the areas of frequency purity and accuracy, harmonics, flatness, and power.

For a complete discussion of swept frequency measurements the following application notes and others are available from your local Hewlett-Packard sales office.

AN 155-1 "Active Device Measurements with the 8755..."

AN 155-2 "100 dB Dynamic Range Measurements, using the 8755 Frequency Response Test Set"

AN 183 "High Frequency Swept Measurements"

AN 187-2 "Configuration of a 2-18.6 GHz Synthesized Frequency Source using the 8620C Sweep Oscillator"

AN 187-4 "Configuration of a Two-Tone Sweeping Generator"

AN 187-5 "Calculator Control of the 8620C Sweep Oscillator using the HP-IB"

AN 187-6 "Frequency Performance of the 8620C Sweep Oscillator Under Remote Programming"

Sweep Oscillator—Summary Chart

Frequency Range*	Model Number				100 kHz	1 MHz	10 MHz	100 MHz	1 GHz	2 GHz	4 GHz	8 GHz	12 GHz	18 GHz	26 GHz	40 GHz
	8350 Series	8620 Series**	8690 Series	Other Sweepers												
0.1 Hz-13 MHz 10 Hz-21 MHz 1 μ Hz-21 MHz 1 mHz-50 MHz 200 Hz-80 MHz 10 kHz-1280 MHz 10 kHz-2600 MHz				3312A 3336A/B/C 3325A 8165A 3335A 8662A 8660C	←	←	←	←	←	←	←	←	←	←	←	←
100 kHz-110 MHz 400 kHz-110 MHz 10 MHz-1.3 GHz 10 MHz-2.4 GHz 10 MHz-8.4 GHz 10 MHz-20 GHz 10 MHz-26.5 GHz	83522A 83525A 83592A 83595A	86220A 86222A/B	8698B	8601A	←	←	←	←	←	←	←	←	←	←	←	←
0.1-4.0 GHz 1.0-2.0 GHz 1.4-2.5 GHz 1.7-4.2 GHz			8699B 8691A/B 8691A Opt 200 8692B Opt 100		←	←	←	←	←	←	←	←	←	←	←	←
1.7-4.3 GHz 1.8-4.2 GHz 2-4 GHz 2.8-4 GHz 3.6-8.6 GHz 2-18.6 GHz 2-20 GHz 2-22 GHz 2-26.5 GHz	83540A 83590A 83594A	86235A 86230B 86240A/B 86240C 86290A/B/C 86290A/B Opt H08	8692A/B		←	←	←	←	←	←	←	←	←	←	←	←
3.2-6.5 GHz 3.5-6.75 GHz 3.7-8.3 GHz 4-8 GHz		86241A		8693A Opt 200 8693B Opt 100 8693A/B	←	←	←	←	←	←	←	←	←	←	←	←
5.9-9.0 GHz 5.9-12.4 GHz 7-11 GHz 8-12.4 GHz 8-18 GHz	83545A	86242D 86245A 86250D Opt H08 86250D		8694A/B Opt 200 8694A/B 8694A/B Opt 300	←	←	←	←	←	←	←	←	←	←	←	←
10-15.5 GHz 12.4-18 GHz 17-22 GHz 18-26.5 GHz 26.5-40 GHz 33-50 GHz	83570A	86260B 86260A 86260C		8695A Opt 100 8695A/B 8696A 8697A 8697A Opt H50	←	←	←	←	←	←	←	←	←	←	←	←

*Other Special Frequency Ranges Can Be Provided Upon Request.

**86200 Series RF Plug-ins are usable with the 8350A Mainframe via the 11869A Adapter. 83500 Series Plug-ins are not usable in the 8620C Mainframe.



SWEEP OSCILLATORS

8350 Family: 10MHz – 26.5 GHz

Model 8350A

- Versatile Microprocessor-Controlled Mainframe
- Single-Band, Straddle-Band and Broad Band Plug-ins
- 10 MHz to 26.5 GHz in one Plug-In
- 8 mW Output Power to 26.5 GHz
- Total HP-IB Programmability

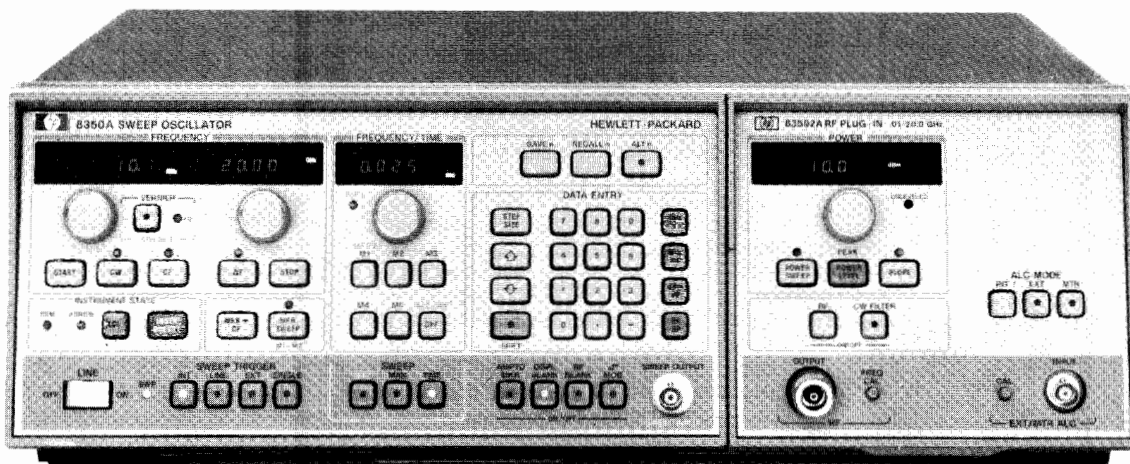

8350 System

The HP 8350 is a powerful RF and microwave source for swept measurements, wideband CW signal generation and automatic testing. It incorporates the efficiency of microprocessor control with state-of-the-art YIG-tuned oscillators and GaAs FET amplifiers to produce a high performance sweep oscillator system ideally suited for either manual or automatic measurements.

You can easily configure a source to meet your application's frequency coverage and power requirements. Just combine the versatile 8350A mainframe with any of the 27 standard RF plug-ins (see table at right) and you are ready to make measurements. Both the advanced 83500 series plug-ins and the existing 86200 series plug-ins (via the 11869A adapter) are accepted by the 8350A mainframe.

8350A Mainframe

The 8350A has been designed to include many features that not only speed and simplify measurements but also improve accuracy. In addition, it is the first sweep oscillator to provide total computer control of all front panel function settings.

All function values (sweep limit frequencies, marker frequencies, etc.) are indicated on high resolution digital displays, thus eliminating the time consuming task of reading and interpolating between dial scale graduations. Function values are easily modified using the appropriate knob, step keys, or data entry keyboard. The knob provides a "continuous" analog feel while the step keys allow values to be increased or decreased by specific amounts. Fast entry of precise values is made from the data entry keyboard.

Five independent, continuously variable markers are available to note your measurement frequencies. The active marker frequency or the difference frequency between any two markers is read easily from high resolution digital display. You can also use marker sweep to zoom in on a particular frequency span while retaining your original sweep limits.

Another particularly useful feature in making repetitive measurements is the 8350A's Save/Recall Mode. Once the sweeper has been set for a particular measurement, all front panel settings (8350A and 83500 series plug-in) can be *Saved* and later *Recalled* to repeat the measurement by accessing one of nine internal storage registers.

In the past, HP-IB programming of sweepers was limited to a series of CW frequencies. With the 8350A all front panel functions, e.g. sweeps, markers, sweep time, even output power (83500 series plug-ins) can be programmed. This means there are no limitations in designing your own customized test systems. Utilizing the Learn Mode function, the 8350A becomes a "talker" as well as "listener" on the bus, transferring all manually entered front panel controls to the computer.

Full compatibility with both the HP 8410B Network Analyzer and the HP 8755 Frequency Response Test Set are provided for convenient vector and scalar measurement with the 8350A. The HP 5343A Counter can be combined with the 8350A to measure Start, Stop, or marker frequencies with up to 100 kHz accuracy while sweeping.

83500 Series Plug-ins

Broadband frequency coverage from 10 MHz to 26.5 GHz with high output power is provided in the 83500 series RF plug-ins. One plug-in, the 83595A, operates over the entire 10 MHz to 26.5 GHz range without sacrificing frequency accuracy (20 MHz at 26.5 GHz). The 18 GHz to 26.5 GHz band is filled by the 83570A RF plug-in and boasts a 8 mW power level (comparable to most BWO's).

The 83500 series plug-ins offer output power level control previously unavailable on a swept source. First, power level control is calibrated with 0.1 dB resolution and up to 80 dB range (with Opt 002 attenuator). Second, calibrated power sweeps are available for characterizing device performance as a function of power. And third, slope and internal leveling controls are standard on all units.

All 83500 series front panel functions and HP-IB programmable including power level. This means your automatic test systems can now characterize a device both as a function of frequency and input power level.

86200 Series Plug-ins

Simply combining the 86200 series plug-in (including the one you may already own) with an 11869A Adapter makes all the convenient digital controls, markers, and HP-IB capability of the 8350A immediately available to you. The 86200 series are a particularly attractive plug-in choice when economical single-band operation is desired with the 8350A mainframe. For measurements with HP Microwave Link Analyzer, specially characterized 86200 series plug-ins can be used with the 8350A to create an upconverter for communications distortion measurements.

The 86290A/B/C plug-ins cover the 2-18 GHz frequency range with 5 mW, 10 mW, and 20 mW of output power respectively. Frequency accuracy at 18 GHz is 20 MHz exceeding that available on most single-band plug-ins. Both 83500 series and 86200 series plug-ins compatible with the 8350A Mainframe are summarized in the table below. Note that the 11869A Adapter is required with all 86200 series plug-ins. See specifications on page 434.

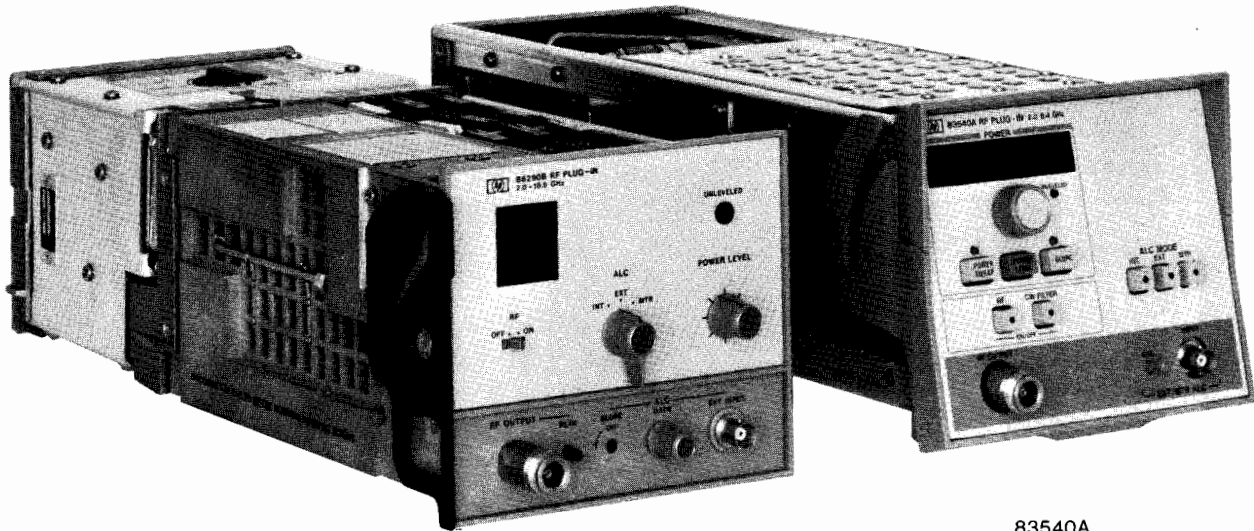

86290B

83540A



	Model number	Frequency range (GHz)	Leveled power output	Frequency accuracy (MHz)	Complete specifications on page
Broad-band Plug-ins	83595A	.01-26.5	4 mW	±30	428, 429
	83594A	2-26.5	4 mW	±30	428, 429
	83592A	.01-20	10 mW	±20	428, 429
	83590A	2-20	10 mW	±20	428, 429
	83525A	.01-8.4	20 mW	±20	430, 431
	83522A	.01-2.4	20 mW	±10	430, 431
	86222A/B	.01-2.4	20 mW	±10	437
	86290A	2-18	5 mW	±20	438
86290B	2-18.6	10 mW	±20	438	
86290C	2-18.6	20 mW	±20	438	
Straddle-band Plug-ins	83540A	2-8.4	40 mW	±20	432, 433
	86240A	2-8.4	40 mW	±20	439
	86240B	2-8.4	20 mW	±20	439
	86240C	3.6-8.6	40 mW	±20	439
Single-band Plug-ins	86220A	.01-1.3	10 mW	±10	440, 441
	86230B	1.8-4.2	10 mW	±15	440, 441
	86235A	1.7-4.3	40 mW	±20	440, 441
	86241A	3.2-6.5	3.2 mW	±30	440, 441
	86242D	5.9-9	10 mW	±35	440, 441
	83545A	5.9-12.4	50 mW	±40	432, 433
	86245A	5.9-12.4	50 mW	±40	440, 441
	86250D	8.0-12.4	10 mW	±40	440, 441
	86260B	10-15.5	10 mW	±50	440, 441
	86260A	12.4-18	10 mW	±50	440, 441
	86260C	17-22	10 mW	±50	440, 441
	83570A	18-26.5	8 mW	±40	432, 433

NOTE: The 11869A Adapter is required to interface 86200 series plug-ins with the 8350A mainframe.

SWEEP OSCILLATORS

- Accurate, high resolution, digital displays
- Five markers with Marker Δ and Marker Sweep
- Save/Recall 9 complete front panel states
- Accepts new 83500 series plug-ins
- Total HP-IB programmability

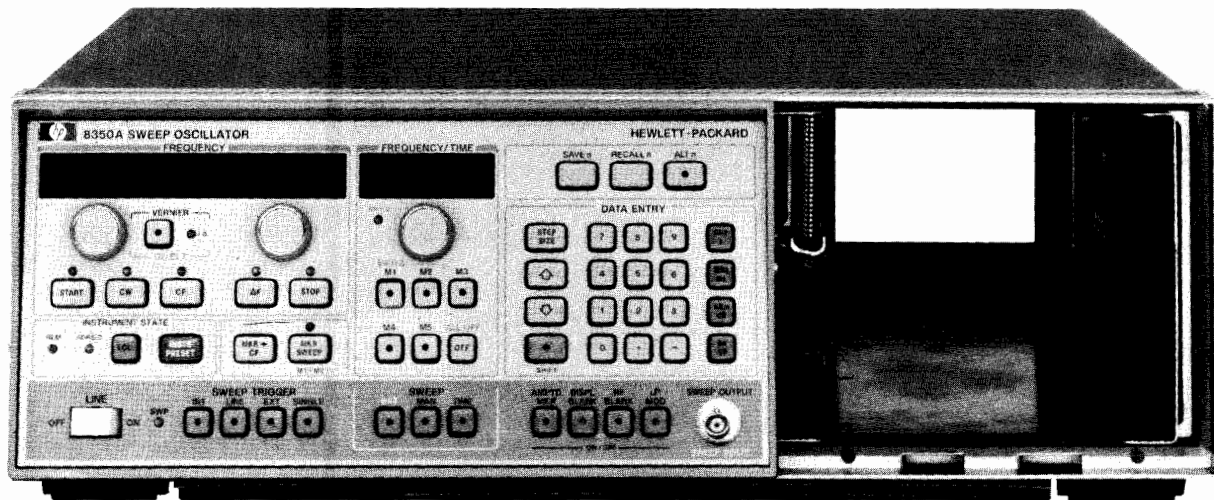

8350A



8350A Mainframe:

Sweep Oscillator applications are greatly expanded by the new features of the HP8350A. Along with the traditional swept and CW frequency functions the 8350A adds five markers with extensive capabilities, versatile data entry and complete HP-IB programmability. The 8350A mainframe accepts the 86200 series plug-ins via the 11869A Adapter as well as the new wideband 83500 series plug-ins. In order to aid system set ups, the 8350A is directly compatible with the HP 8410B and HP8755 network analyzers. The frequency accuracy is easily enhanced when the HP5343 Counter is used to count the START, STOP, or ACTIVE MARKER frequency.

The 8350A has three methods of changing function values; control knobs, keyboard entry, or step key entry. The traditional control knob provides an analog "feel" of control which is useful for continuous parameter adjustment. Numerical keyboard entry allows for fast, accurate input. Finally, quantized inputs are possible with step keys.

Five markers are available with the 8350A. These markers combined with the high resolution digital readout make the accurate location of important frequency responses easy. A key marker feature, marker Δ , computes the difference between any two markers. While the markers are in this mode the trace is intensified between the two markers, thereby aiding the user's visual comprehension. This feature is particularly useful for measurements such as the determination of the bandwidth between 3 dB points. With the extensive marker capabilities key frequency ranges may be marked and swept. The markers can modify the center frequency (marker — CF) or the START/STOP frequency (Marker Sweep). These expanded marker capabilities simplify sophisticated measurements.

A necessity in making repetitive measurements or automatic tests is the Save/Recall Feature. Once the 8350A controls have been set for a particular measurement, all of the front panel controls can be "saved" in a memory location and later "recalled" when the measurement is

repeated. This feature supplies nine memory locations, each storing a complete front panel set up. Memory storage or access may be done randomly or sequentially. Option 001 provides a non-volatile memory in which all memories are retained even when line power is removed.

The HP8350A makes "simultaneous" comparison of two separate frequency ranges or power levels easy via the alternate sweep mode. When the alternate sweep mode is activated the 8350 alternates between the current front panel setting and any stored memory setting on successive sweeps. The output from this function may be processed through a network analyzer such as the HP8755C and viewed on a two channel display.

All front panel controls (except the ac line power switch) may be programmed or controlled via the HP-IB. The 8350A may interact as a listener or as a talker on the HP-IB. As a talker the 8350A is capable of outputting the manually entered front panel information to a controller. The HP-IB capabilities of the 8350 are far more extensive than in other sweepers hence increasing its range of applications.

As a result of the 8350's internal microprocessor design, a self test is performed at turn on or whenever the instrument pre-set function is activated. This function verifies that the 8350A is functioning properly. If there is a problem, error codes are displayed on the front panel to help locate the problem quickly to the board and component level.

In the 8350A the frequency resolution is determined by the digital to analog converters that are used to produce the tuning voltage and marker pulses. The center frequency resolution is 0.024% of the full band (4096 points across the band). A vernier is used to increase the CF resolution by adding 64 points between each CF point which increases the CF resolution to 0.00038% of the full band range. The ΔF resolution is variable, such that higher resolution is provided for narrow sweep widths. The ΔF resolution is 0.1% of the full band range for full bands sweeps and improves to 0.0015% of the full band range for very narrow band sweeps.

8350A Specifications

Instrument Control

Control knobs, Step keys and data entry keyboard: All instrument parameters whether time, frequency or power may be set three ways: control knobs, keyboard entry, or step keys. The step size either can be entered by the user or the pre-programmed default values may be used. The SHIFT key is used to effect the functions written in blue.

Frequency Control Functions

Range: Determined by RF plug-in unit used

Linearity: Refer to RF unit specifications

START/STOP sweep: Sweeps up from the START frequency to the STOP frequency.

CF/ΔF Sweep: Sweeps symmetrically upward, centered on CF

ΔF: Frequency Width of sweep. Continuously adjustable from zero to 100% of frequency range.

ΔF Accuracy: Refer to RF unit specifications.

CF Accuracy: Refer to RF unit specifications.

CF Resolution: 0.24% (4096 points across band)

ΔF Resolution: 0.1% of full band (1024 points across band)

0.012% of band for 1/2 of band or less

0.0015% of band for 1/4 of band or less

Display resolution: 5 digits

CW Operation: Single frequency RF output.

CW Accuracy: Refer to RF unit specifications.

CW Resolution: Same as CF.

Vernier: Adjusts CW frequency or swept center frequency up to 0.05% of RF plug-in band being swept.

Vernier resolution: 4 ppm (64 points between each CW point; 262, 144 points across band)

Offset: Allows the CW frequency or center frequency to be offset by any amount up to the full range of the plug-in.

Resolution: same as CF

Accuracy: Refer to RF unit specifications

Frequency markers: Five frequency markers are independently adjustable and fully calibrated over the entire sweep range. Amplitude or intensity markers available.

Resolution: 0.4% of selected sweep width (256 points/sweep)

Accuracy: Refer to frequency accuracy.

Marker output: Rectangular pulse, typically -5 volts peak available from the POS Z BLANK connector on rear panel.

Marker sweep: RF output is swept between Marker 1 and Marker 2.

Marker—CF: Causes the CW or the swept center frequency to equal the frequency of the active marker.

Sweep and Trigger Modes

Internal: Sweep recurs automatically

Line: Sweep triggered by ac power line frequency.

External trigger: Sweep is actuated by external trigger signal.

Single: Selects mode and triggers a single sweep.

Sweep time: Continuously adjustable from 10 msec to 100 seconds.

Manual sweep: Front panel controls provide continuous manual adjustment of frequency between end frequencies.

External sweep: Sweep is controlled by external signal applied to front or rear panel SWP OUTPUT/SWP INPUT connector.

Sweep output: Direct-coupled sawtooth, zero to approximately ± 10 volts, at front or rear panel concurrent with swept RF output.

Instrument State Storage

Save n / Recall n: Up to 9 different front panel settings can be stored in the 8350A via the Save n (n = 1 through 9) function. Settings can be recalled randomly or in sequence.

Alt n: Causes the RF output to alternate on successive sweeps between the current front panel setting and a setting stored in memory.

Instrument State

Instrument preset: Sets the front panel of the 8350A into a pre-determined state. It also causes an internal analog and digital self-test to occur. If internal errors or failures are detected they are indicated via error codes.

Local operation: This key is used to return the 8350A to local control from the remotely controlled state. The REM lamp indicates remote control. The ADRS'D lamp indicates transmitted or received data over the HP-IB.

Modulation

External AM: Refer to RF unit specifications.

Internal AM: Square wave modulation available at all sweep speeds. Factory preset to 27.8 kHz although selectable to 1000 Hz or 27.8 kHz. On/off ratio, refer to RF unit specifications.

External FM: Refer to RF unit specifications.

Phase-lock: Refer to RF unit specifications.

Remote Programming (HP-IB)

The 8350A has both input and output capability. The HP-IB address can be displayed on the front panel and is selectable (any number from 0 to 31).

Input mode functions: All front panel controls except the ac line power switch are programmable. Numerical values typically have greater entry resolution than is displayed.

Frequency resolution: Same as CF/ΔF plus vernier.

Power resolution: See 83500 Series Plug-ins.

Output mode functions: The 8350A can output to a controller an instrument state message that describes the present instrument status.

General Specifications

Non volatile memory:

Option 001: Continuous memory that retains the contents of all instrument state storage registers, the HP-IB address, and current instrument state when ac line power is off.

Blanking:

RF: When enabled, RF turns off during retrace and remains off until next sweep.

Display: POS Z BLANK; direct-coupled rectangular pulse approximately +5.0 volts during retrace and bandswitch points of sweep. NEG Z BLANK; direct-coupled rectangular pulse approximately -5.0 volts coincident in time with RF blanking.

Pen Lift: Output to control the pen lift function of XY recorder at end point of sweep.

Counter trigger (CNTR TRIG): Output for controlling the external trigger input of the HP 5343A Frequency Counter.

Stop sweep: Input for stopping the progress of a forward sweep, used with HP 5343A Frequency Counter.

Program connector: Additional control of and information on the 8350A instrument state is provided via a 25 pin rear panel connector.

8410B Interface Cable: Permits multi-octave operation of HP 8410B Network Analyzer with 8350A.

Operating temperature range: 0°C to +55°C

Power: 100, 120, 220 or 240 volts +5-10%, 50 to 60 Hz (Option 400, 60 to 400 Hz). Approximately 270 volt-amperes including RF unit.

Weight (not including RF unit): Net 16.5 kg (36.4 lb). Shipping 22.7 kg (50 lb)

Dimensions: 425 mm wide, 133.3 mm high, 422 mm deep (16.75" x 5.25" x 16.6")

Ordering Information

8350A Sweep Oscillator Mainframe

Price
\$4250

Options:

001: Non-Volatile Memory	add \$250
400: 400 Hz Power Line Frequency Operation	add \$200
907: Front Handles Kit	add \$32
908: Rack Mounting Kit	add \$25
909: Rack Mounting/Front Handles Kit	add \$55
910: Extra Manual	add \$25
803: HP 5343A Interface Cables	add \$60
850: HP 8410B Source Control Cable	add \$100



SWEEP OSCILLATORS

8350A Family: Broadband Plug-ins

Models 83595A, 83592A, 83594A, 83590A

- Calibrated output power with 0.1 dB resolution
- +10 dBm from 0.01–20 GHz
- 20 MHz frequency accuracy at 26.5 GHz

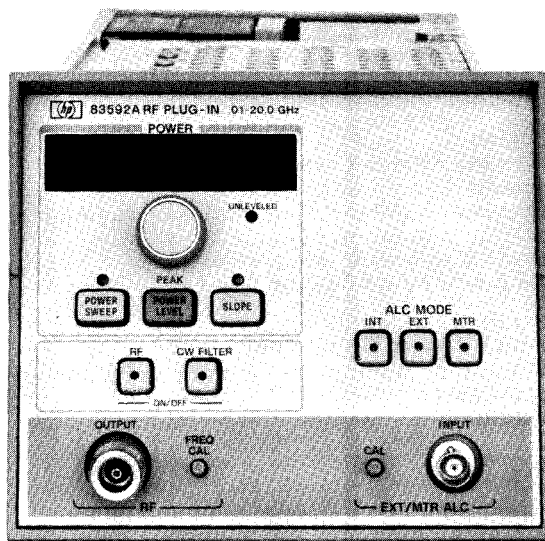

83592A



The four 83590 series plug-ins feature ultra-wideband frequency coverage as exemplified by the 83595A which covers 0.01–26.5 GHz in a single sweep. While the 83590 series features broadband sweeps, they still maintain narrowband precision. The frequency output exhibits excellent stability and accuracy. At 26.5 GHz the 83595A maintains an accuracy of ± 20 MHz. The 83592A does not sacrifice power for broadband high frequency coverage, the output power is internally leveled for a minimum ± 10 dBm output with ± 0.9 dB flatness. Power output capabilities have been expanded to provide power sweep and slope control. In addition the 83590 series plug-ins are completely HP-IB programmable.

The most outstanding feature of the 83590 series plug-ins is their broad frequency range. Innovative technology is used to create this precision frequency range. The principle behind this technology is the Switched YIG Tuned Multiplier circuit (SYTM). This circuit contains a pin diode switch and a YIG Tuned Multiplier (YTM) in a single package. More specifically, the YTM circuit uses the output of a fundamental oscillator to drive a high-efficiency multiplier that has been integrated together with a tracking YIG filter in order to create and select high order harmonics to be used as output frequencies. On the 83595A, for example, the PIN diode allows the low frequency heterodyne band to be switched to the output for a single 0.01–26.5 GHz sweep. From this method, five frequency bands may be identified; one from the heterodyne, and then four bands resulting from the 1st, 2nd, 3rd or 4th harmonics. For wideband sweeps these bands have very small overlap areas (20 MHz), yet for narrow band sweeps these bands are flexible enough to contain the complete sweep in one band.

Another figure of merit for the 83590 series are their flat output power over the entire frequency range. The output power is internally leveled within 0.9 dB for a minimum output power of 10 dBm, with a displayed resolution of 0.1 dB. The power level may be controlled to a minimum settable power level of -5 dBm. This level may be extended to -75 dBm on the 83592A and 83590A with Option 002 (70 dB Step Attenuator) or to -60 dBm on the 83595A and 83594A with Option 002 (55 dB Step Attenuator).

Since power parameters are critical to high frequency measurements the 83590 Series (along with all 83500 series plug-ins) offer many modes of power output. In addition to a single power output, the 83590 Series offers a power sweep function. The power sweep function sweeps a power range for characterizing level sensitive devices like amplifiers and transistors. The slope mode is also supplied to provide compensation for cable or test set losses. In all these modes

- Internal leveling and slope standard
- HP-IB

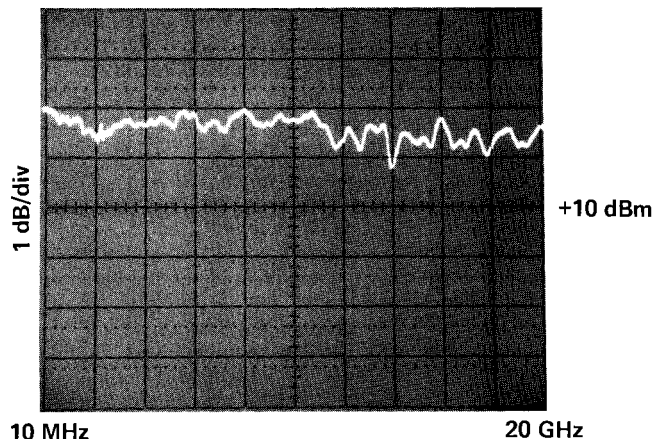

10 MHz

20 GHz

the power output is internally monitored and leveled. If preferred, the power may be externally leveled.

HP-IB programmability is an essential feature when one of the 83590 series is used in automatic test systems. For example, the automated tests of amplifiers for gain compression are possible. These plug-ins are completely programmable which means the power mode may be set, or the power level may be set with .02 dB resolution.

The 83590 series plug-ins are excellent sources for high frequency, broadband network measurements. These plug-ins accept a 27.8 kHz squarewave modulation from the 8350 mainframe and hence become directly compatible with the HP 8755 Frequency Response Test Set. By eliminating the need for an external modulator, full sweeper power is available at the test device. Phase/Amplitude network analysis is possible when these plug-ins are used in conjunction with the HP 8410B Network Analyzer. The 8410B becomes automatically phase-locked over multi-octave sweeps when it is interfaced with a source control cable from the 8350A mainframe and the 1V/GHz from the plug-in. In addition, a low frequency, auxiliary output may be used for counting or phase-locking to improve the frequency accuracy and stability.

General Specifications

Sweep time (minimum): 10 msec for a single band (Bands 0, 1, 2, 3, 4). 25 msec for full band.

Switch Points: 83595A, 83592A: Internal bands are 0.01–2.4 GHz, 2.3–7.0 GHz, 6.9–13.5 GHz, 13.4–20.0 GHz and 19.9–26.5 GHz (83595A only). Broadband switch points are at approximately 2.4 GHz, 7.0 GHz, 13.5 GHz and 20.0 GHz (83595 only). 83594A, 83590A: Internal bands are 2.0–7.0 GHz, 6.9–13.5 GHz, 13.4–20.0 GHz and 19.9–26.5 GHz (83594A only). Broadband switch points are at approximately 7.0 GHz, 13.5 GHz and 20.0 GHz (83594A only).

Auxiliary Output: 83595A, 83592A: Rear Panel 2.3–7.0 GHz fundamental oscillator output, nominally 0 dBm 83594A, 83590A: Rear Panel 2.0–7.0 GHz fundamental oscillator output, nominally 0 dBm.

Frequency Reference Output: 83595A, 83592A: nominal 1V/GHz (0.01–19 GHz) ± 20 mV rear panel BNC output. 83594A, 83590A: Nominal 1V/GHz (2–19 GHz) ± 20 mV rear panel BNC output.

RF Output Connector: 83595A, 83594A: Type APC 3.5 male. 83592A, 83590A: Type N female (Option 005 APC–7 RF Output Connector).

Weight: Net 6.0 kg (13.2 lb.) Shipping 9.2 kg (20 lb.)

Output Characteristics

Impedance: 50 Ω nominal

VSWR: <1.9:1

Power Sweep (with option 002 Power Sweep cannot cross an attenuator step)

Calibrated range: 83590A, 83592A: >10 dB (15 dB typical); 83594A, 83595A: 9 dB

Accuracy (Including Linearity): < ±1.5 dB typical

Resolution: 0.1 dB

Slope Compensation (with option 002 Slope cannot cross an attenuator step)

Calibrated range: Up to 5 dB/GHz (10 dB over full range)

Linearity: <.3 dB typical

Resolution: 0.1 dB/GHz

Modulation Characteristics

External AM

Frequency response: Typically 100 kHz

Input impedance: Approximately 10 kΩ

Range of amplitude control: Typically 15 dB

Sensitivity: 1 dB/V typical

Maximum input: 15 V

External FM

Maximum Deviations for Modulation Frequencies

DC to 100 Hz: ± 75 MHz

100 Hz to 1 MHz: ± 10 MHz

1 MHz to 2 MHz: ± 5 MHz

2 MHz to 10 MHz: ± 1.5 MHz

Sensitivity

FM Mode: -20 MHz/V typical

Phase-lock mode: -6 MHz/V typical

Input Impedance: 2 kΩ nominal

Frequency response: (DC to 2 MHz): ± 3 dB

Ordering Information

83590A 2.0 to 20 GHz RF Plug-in

Option 002: 70 dB Step Attenuator

Option 004: Rear Panel RF Output

83592A 0.01 to 20 GHz RF Plug-in

Option 002: 70 dB Step Attenuator

Option 004: Rear Panel RF Output

83594A 2.0 to 26.5 GHz RF Plug-in

Option 002: 55 dB Step Attenuator

Option 004: Rear Panel RF Output

83595A 0.01 to 26.5 GHz RF Plug-in

Option 002: 55 dB Step Attenuator

Option 004: Rear Panel RF Output

Price

\$19,250

add \$900

add \$150

\$23,500

add \$900

add \$150

\$22,750

add \$900

add \$150

\$27,000

add \$900

add \$150

	83592A 83590A (excluding Band 0)					83595A 83594A (excluding Band 0)					
	Band 0	Band* 1	Band 2	Band 3	Full Band	Band 0	Band* 1	Band 2	Band 3	Band 4	Full Band
	.01-2.4	2.4-7.0	7.0-13.5	13.5-20	.01-20	.01-2.4	2.4-7.0	7.0-13.5	13.5-20	20-26.5	.01-26.5
Frequency Characteristics											
Accuracy: (25°C ± 5°C)											
CW Mode: (MHz)	± 5	± 5	± 10	± 15		± 5	± 5	± 10	± 15	± 20	
Typically: (MHz)	± 2	± 2	± 3	± 4		± 2	± 2	± 3	± 4	± 5	
All Sweep Modes (100msec Sweep Time): (MHz)	± 15	± 20	± 25	± 30	± 50	± 15	± 20	± 25	± 30	± 35	± 50
Linearity: Typ. (MHz)	± 2	± 2	± 4	± 6	± 10	± 2	± 2	± 4	± 6	± 8	± 10
Stability											
With Temperature: Typically (MHz/°C)	± .2	± .2	± .4	± .6	± .6	± .2	± .2	± .4	± .6	± .8	± .8
With 10% Line Voltage Change: (kHz)	± 50	± 50	± 100	± 150	± 150	± 50	± 50	± 100	± 150	± 200	± 200
With 10 Power Level Change: (kHz)	± 200	± 200	± 400	± 600	± 600	± 200	± 200	± 400	± 600	± 800	± 800
With 3:1 Load VSWR: (kHz)	± 100	± 100	± 200	± 300	± 300	± 100	± 100	± 200	± 300	± 400	± 400
With Time (in 10 minute period after 1 hour warmup)											
Typically (kHz)	<100	<100	<200	<300	<300	<100	<100	<200	<300	<400	<400
Residual FM (10 kHz bandwidth, peak): (kHz)	<8	<8	<15	<15		<8	<8	<15	<15	<20	
Output Characteristics											
Maximum Leveled Power: (mW) (25 C 5 C)	10	10	10	10	6.3	10	10	10	10	4	2.5
Power Level Accuracy											
(Internally Leveled): (dB)	<±1.5	<±1.3	<±1.3	<±1.4	<±1.5	<±1.5	<±1.3	<±1.3	<±1.4	<±2.0	<±2.0
Minimum Settable Power: (dBm)	-5	-5	-5	-5	-5	-5	-5	-5	-5	-5	-5
Remote Programming Resolution Displayed: (dB)	.1	.1	.1	.1	.1	.1	.1	.1	.1	.1	.1
Settable (dB)	.02	.02	.02	.02	.02	.02	.02	.02	.02	.02	.02
Power Variation (Max. Rated Pwr)											
Internally Leveled: (dB)	<±.9	<±.7	<±.7	<±.8	<±.9	±.9	±.7	±.7	±.8	±.9	±1.0
Externally Leveled (Excludes Coupler/Detector Variation)											
(For Negative Crystal Detector and HP 432A/B/C Power Meter: (dB)	<±.2	<±.2	<±.2	<±.2	<±.2	<±.2	<±.2	<±.2	<±.2	<±.2	<±.2
With Temperature: (dB/C)	.1	.1	.1	.1	.1	.1	.1	.1	.1	.1	.1
Residual AM in 100 kHz Bandwidth: (dBc)	>50	>50	>50	>50	>50	>50	>50	>50	>50	>50	>50
Spurious Signals											
Harmonically Related: (dBc)	>25	>25	>25	>25	>25	>25	>25	>25	>25	>20	>20
Typically: (dBc)	>35	>40	>35	>35	>35	>35	>40	>35	>35	>25	>25
Non-Harmonics: (dBc)	>25	>50	>50	>50	>25	>25	>50	>50	>50	>50	>50

*Band 1 on the 83590A and the 83594A covers 2.0-7.0 GHz.

SWEEP OSCILLATORS

8350 Family: Broadband Plug-ins

Models 83522A and 83525A

- 10MHz-2.4 GHz and 10 MHz-8.4 GHz in one continuous sweep
- Calibrated Output Power
- Power Sweep
- 1, 10, and 50 MHz Crystal Markers

- Complete HP-IB programmability
- Internally leveled flatness
 $\pm .25$ dB over full band 83522A
 ± 1 dB over full band 83525A

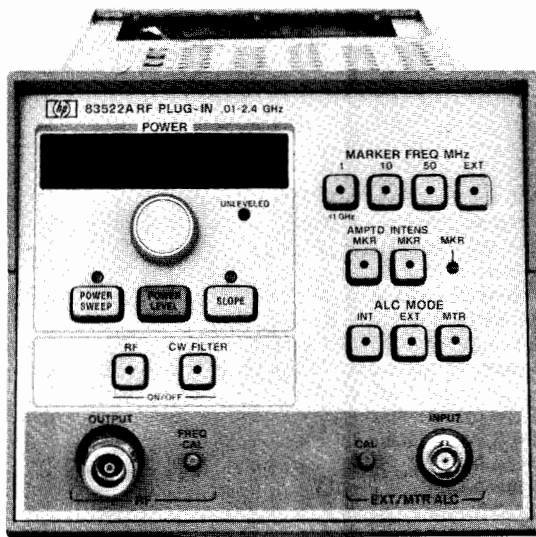

83522A

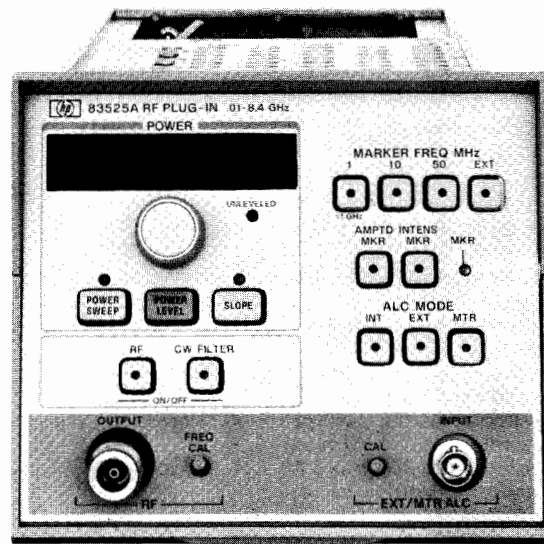

83525A



Broadband frequency measurements may be made with the HP83522A (10 MHz to 2.4 GHz) plug-in and the HP 83525A (10 MHz to 8.4 GHz) plug-in. These plug-ins have similar functions as well as individual merits which are all described in the following article.

83522A

The 83522A uses a heterodyne circuit to provide high performance 10 MHz to 2.4 GHz frequency coverage. This frequency range is covered in one continuous sweep having excellent frequency characteristics. Frequency accuracy is maintained within 5 MHz and the linearity is within 2 MHz over the full band. The power output is internally leveled to ± 0.25 dB flatness over the entire 10 MHz to 2.4 GHz range while maintaining a power level ≥ 13 dBm.

83525A

The 83525A covers the unmatched frequency range of 10 MHz to 8.4 GHz with excellent frequency stability, accuracy, and output power. This wide frequency range is created by automatically switching two bands together with a PIN diode switch. The lower frequency band covers 0.01-2.1 GHz which results from a heterodyne circuit. The upper frequency band is produced by a 2-8.4 GHz YIG oscillator. This 0.1 GHz frequency overlap is provided to enable smooth, narrowband sweeps around the switch point. On a full band sweep (10 MHz to 8.4 GHz) the band discontinuity at the switchpoint will be typically < 15 MHz. The 83525A maintains excellent frequency parameters with a lower band accuracy within ± 5 MHz and an upper band accuracy within 15 MHz. Full band frequency linearity is ± 6 MHz while the lower band maintains a linearity of ± 2 MHz.

The 83525A plug-in, with its extremely broad frequency range, does not sacrifice power. This plug-in provides at least +13 dBm of output power while being internally leveled to a flatness of ± 1 dBm.

83522/83525 Common Features

Crystal Marker Capability

A powerful feature offered by both the 83522A and the 83525A is Crystal Marker capability. This capability provides harmonic markers at 10 or 50 MHz intervals over the full range of the 83522A and below 2 GHz with the 83525A. In addition, 1 MHz harmonic markers are available below 1 GHz with both plug-ins. These markers may

either be seen as intensity spots or amplitude dips. The x-axis intensity markers are compatible with the HP8755 Swept Frequency Response Test Set. These crystal markers simplify and speed up precision frequency measurements.

Power Output

Both the 83522A and the 83525A have a calibrated output power range of typically 15 dB that may be extended to 80 dB with Option 002 (70 dB attenuator). The output power level accuracy is within 1 dB on the 83522A and within 1.5 dB on the 83525A. The front panel digital resolution enables the power to be manually set to a 0.1 dB resolution. The power may be remotely HP-IB programmed to 0.02 dB resolution.

These plug-ins also offer a variety of power functions. An innovative feature offered on these plug-ins is Power Sweep, which sweeps the output power from one level to another. With this function, power response measurements may be made in a single test. Slope compensation is provided for situations that involve lossy cables or test set ups. This function slopes the power to compensate for high frequency losses via a "Slope" control.

Programmability

The 83522A and the 83525A are completely programmable plug-ins. This infers that the power level, power mode (Power Sweep, Slope, etc.), crystal markers and other plug-in functions may be externally controlled via the HP-IB. Programmability is a key feature for automatic test systems or production environments requiring multiple, repetitive tests.

Network Measurements

Increased dynamic range scalar measurements can be made using either the HP83522A or the 83525A with the HP8755 Swept Frequency Response Test Set. The dynamic range is increased by internally modulating the RF output with the required 27.8 KHz square wave (produced by the 8350A). This causes the output to be modulated before it is passed through the output amplifier, thereby avoiding modulation of the amplifier noise. The advantage of increased dynamic range is complemented by the simple interface between the sweep oscillator and the HP8755. In addition these plug-ins are directly compatible with the HP 8410B Network Analyzer for vector measurements.



Frequency Characteristics

Range	83522A		83525A	
	.01-2.4 GHz		.01-8.4 GHz	
			.01-2 GHz	2-8.4 GHz
Accuracy¹ (25°C ± 5°C)				
CW Mode:	± 5 MHz	± 5 MHz	± 5 MHz	± 15 MHz
Typically:	± 1.5 MHz	± 1.5 MHz	± 1.5 MHz	± 3.5 MHz
All Sweep Modes	± 15 MHz	± 15 MHz	± 15 MHz	± 20 MHz
Linearity Typically:	± 2 MHz	± 2 MHz	± 2 MHz	± 6 MHz
Stability				
With Temperature: Typically	± 200 kHz/°C	± 200 kHz/°C	± 200 kHz/°C	± 200 kHz/°C
With 10% Line Voltage Change:	± 20 kHz	± 20 kHz	± 20 kHz	± 20 kHz
With 10 dB Power Level Change:	± 100 kHz	± 100 kHz	± 100 kHz	± 1 MHz
With 3:1 Load SWR:	± 10 kHz	± 10 kHz	± 10 kHz	± 250 kHz
With Time (in 10 minute period one hour after warmup): Typically	± 100 kHz	± 100 kHz	± 100 kHz	± 200 kHz
Residual FM (10 Hz-10 KHz Bandwidth), peak	< 5 kHz	< 5 kHz	< 5 kHz	< 9 kHz

¹When calibrated using internal crystal markers and FREQ CAL adjustment.

Output Characteristics

	83522A		83525A	
			.01-2 GHz	2-8.4 GHz
Maximum Leveled Output Power (25°C ± 5°C) With Option 002	+20 mW	+20 mW	+20 mW	+20 mW
Power Level Accuracy (Internally Leveled):	± 1 dB	± 1.5 dB	± 1.5 dB	± 1.5 dB
Calibrated Range:	15 dB	15 dB	15 dB	15 dB
With Option 002:	85 dB	85 dB	85 dB	85 dB
Attenuator Accuracy (per 10 dB step):	± .5 dB	± .3 dB	± .3 dB	± .3 dB
Resolution (displayed):	.1 dB	.1 dB	.1 dB	.1 dB
Remote Programming (Settable):	± .02 dB	± .02 dB	± .02 dB	± .02 dB
Power Variation (Max. Rated Pwr) Internally Leveled:	± .25 dB	± 1 dB	± 1 dB	± 1 dB
Externally Leveled (Excludes Coupler/Detector Variation) For Negative Crystal Detector and HP 432A/B/C Power Meter: With Temperature:	< ± .1 dB ± .02 dB/°C	< ± .1 dB ± .02 dB/°C	< ± .1 dB ± .02 dB/°C	< ± .1 dB ± .02 dB/°C
Residual AM in 100 kHz Bandwidth:	> 50 dBc	> 50 dBc	> 50 dBc	> 50 dBc
Spurious Signals				
Harmonics:	> 25 dBc	> 20 dBc	> 20 dBc	> 20 dBc
Typical:	> 30 dBc	> 25 dBc	> 25 dBc	> 25 dBc
Non-Harmonics:	> 25 dBc	> 30 dBc	> 30 dBc	> 60 dBc
Typical:	> 30 dBc	> 35 dBc	> 35 dBc	> 60 dBc
Output VSWR (internally leveled)	< 1.5	< 2.0	< 2.0	< 1.6

Impedance: 50 Ω nominal

Power Sweep

Calibrated range: 15 dB

Accuracy (Including linearity): < ± 1.5 dB Typical

Resolution: 0.1 dB

Slope Compensation

Calibrated range: up to 1 dB/GHz (10 dB over full range, typically 15 dB)

Linearity: < .2 dB Typical

Resolution: .1 dB/GHz

Modulation Characteristics

External AM

Frequency response: 100 kHz Typically

Input impedance: Approximately 10 kΩ

Range of amplitude control: 15 dB Typically

Sensitivity: 1 dB/V Typically

Maximum input: 15 V

Pulse modulation: (83525A, 2-8.4 GHz)

Rise/fall time: 20 nsec Typically

Minimum pulse width: Leveled: 400 nsec Typically

Unleveled: 50 nsec Typically

Internal AM

Selectable (by Internal Jumper in 8350A) to 1 kHz or 27.8 kHz square wave modulation. 27.8 kHz Modulation guarantees operation with HP 8755 Frequency Response Test Set.

On/Off Ratio: ≥ 30 dB (> 40 dB above 2 GHz)

External FM

Maximum Deviations for Modulation Frequencies

DC to 100 Hz: ± 75 MHz

100 Hz to 1 MHz: ± 7 MHz

1 MHz to 2 MHz: ± 5 MHz

2 MHz to 10 MHz: ± 1 MHz

Sensitivity

FM Mode: -20 MHz/V Typical

Phase-lock mode: -6 MHz/V Typical

Input impedance: 2 kΩ nominal

Frequency response (DC to 2 MHz): ± 3 dB

Crystal Marker Capability

Internal crystal markers: Harmonic markers of 10 and 50 MHz are available over the full range of the 83522A and below 2 GHz with 83525A. 1 MHz harmonic markers are available below 1 GHz with the 83522A and 83525A. Markers are output as intensity spots through the POS Z BLANK connector on the 8350A or as amplitude dips on the RF output.

Accuracy of center frequencies (25°C): ± 5 x 10⁻⁶

Typical Marker Width Around Center Frequency

1 MHz Markers: ± 100 kHz

10 MHz Markers: ± 200 kHz

50 MHz Markers: ± 300 kHz

Temperature stability: ± 2 x 10⁻⁶/°C Typically

External marker input: Generates amplitude or Z-axis marker when sweep frequency equals external input frequency.

Frequency range: .01 to 2.4 GHz

Marker width: ± 300 kHz

Marker indicator light: LED lights when coincident with crystal or external marker for accurate CW calibration.

General Specifications

Sweep Time (minimum over full band)

83522A (.01-2.4 GHz): 10 ms

83525A (.01-8.4 GHz): 17 ms

Switch points (83525A Only): Low Band .01-2.1 GHz, High Band 2.0-8.4 GHz. Internal band switch point at 2.0-2.1 GHz

Frequency reference output: Nominal 1 V/GHz (over full sweep range) ± 10 mV rear panel BNC output.

RF Output connector: Type N female

Weight: Net 4.5 kg. (10 lb.). Shipping 7.7 kg. (17 lb.)

Ordering Information

83522A +13 dBm .01-2.4 GHz RF Plug-in

Price

\$7,450

Options:

002: Programmable 70 dB Step Attenuator (10 dB steps) add \$800

004: Rear Panel RF Output add \$150

83525A +13 dBm .01-8.4 GHz RF Plug-in

\$12,500

Options:

002: Programmable 70 dB Step Attenuator (10 dB steps) add \$700

004: Rear Panel RF Output add \$150

SWEEP OSCILLATORS

8350 Family: RF Plug-Ins

Models 83540A, 83545A, 83570A

- 83570A offers 7.9 mW internally leveled 18-26.5 GHz output
- 83540A offers 40 mW internally leveled 2-8.4 GHz output
- 83540A offers 50 mW internally leveled 5.9-12.4 GHz output
- Calibrated Output Power with 0.1 dB resolution
- Power Sweep
- Complete HP-IB programmability

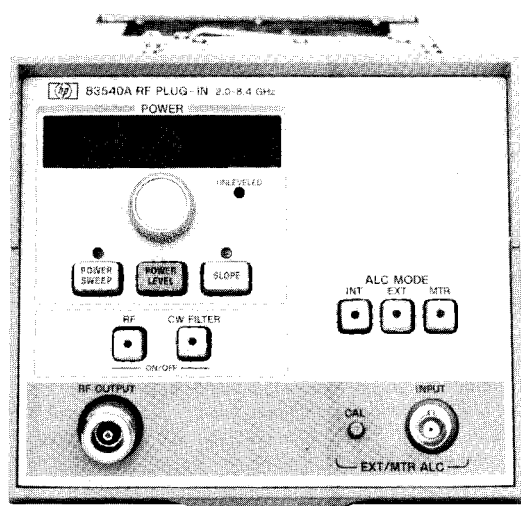

83540A

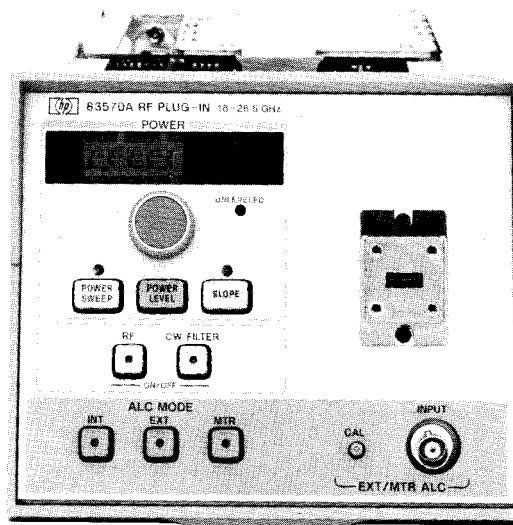

83570A



83570A

Now precision measurements to 26.5 GHz are possible with the solid state 83570 plug-in. The 83570 plug-in maintains a minimum leveled output power of 9 dBm which is comparable to the output power of Backward Wave Oscillators. Power is internally leveled to a flatness $< \pm 1.4$ dB. At the output, power losses are minimized with a waveguide output connector (a coaxial output connector may be made using the HP K281C Adapter). Full range coverage of the 83570 extends from 18 GHz to 26.5 GHz. This frequency range maintains a 30 MHz frequency accuracy and 0.1% linearity. With high frequency coverage, complete HP-IB programmability and outstanding leveled output power, the 83570 plug-in, combined with the many features of the 8350A mainframe adds a new dimension to microwave measurements above 18 GHz.

The output power has a calibrated range of 15 dB which can be extended with external attenuators such as the HP 8495K. The power level may be manually set to a 0.1 dB resolution, or the power level may be remotely HP-IB programmed to a 0.02 dB resolution. In addition to a single output power, the 83570 also has a power sweep function. This function sweeps the power from one level to another. Another important feature that the 83570 offers is slope compensation. This compensates for high frequency power losses in external tests by attenuating the power at lower frequencies.

Scalar measurements at high frequencies may be easily made since the 83570 provides internal 27.8 KHz modulation required to inter-

face with the HP 8755 Swept Frequency Response Test Set. In addition to simplifying the interface circuitry, internal modulation reduces connection losses which are critical at high frequencies.

The 18-26.5 GHz signal is generated by doubling the output of a 9-13.25 GHz YIG oscillator. This half frequency is coupled off to an output which may be used for phase locking or counting. Key to the high power of the HP 83570 is a single doubler package. This package contains the frequency doubler, amplifier, modulator and the leveling coupler with detector. This single package configuration significantly reduces power losses. (See 83570A Block Diagram.)

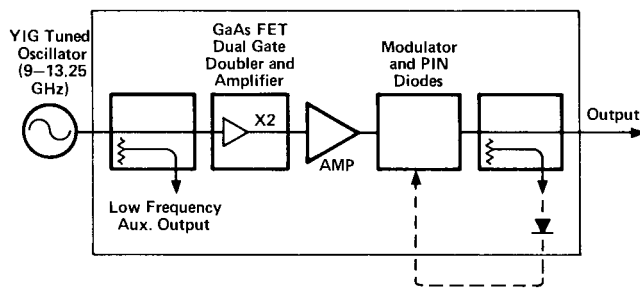

83570A Block Diagram

83540A

High power, high performance, straddle band frequency coverage from 2-8.4 GHz is provided by the 83540 plug-in. The output power is leveled at a minimum of 16 dBm with variations less than 1 dB. The calibrated power output range is 15 dB which may be extended to 80 dB with Option 002 (70 dB Step Attenuator). This plug-in also features Power Sweep which allows power response measurements to be made in a single test. Another power function is slope compensation which adjusts for high frequency cable or test set losses. All plug-in features are completely HP-IB programmable. The frequency outputs are accurate within 15 MHz while maintaining a full band linearity typically within 0.1%. In addition to its sweeper functions, the 83540 is also directly compatible with the HP 8755 Swept Frequency Response Test Set and the HP 8410B Network Analyzer.

83545A

The 83545 plug-in features high performance 5.9-12.4 GHz frequency coverage with exceptionally high output power. The output power is internally leveled to at least 17 dB, with power variations less than 0.6 dB! The calibrated output power has a range of 15 dB which is expandable to 80 dB with Option 002 (70 dB Step Attenuator). A power sweep function is available for power response measurements. In addition, the 83545 provides slope compensation and complete HP-IB programmability. The frequency output is accurate to 20 MHz with excellent stability and linearity (typically 0.1%). Network analysis is simplified since the 83545 provides 27.8 kHz internal modulation for direct compatibility with the HP 8755 Swept Frequency Response Test Set and it is also directly compatible with the HP 8410B Network Analyzer.

Frequency Characteristics

Linearity: (83540A, 83545A, 83570) ± 0.1 Typically
Reference output: (83540A, 83545A) DC-coupled voltage proportional to RF frequency. Typically 1V/GHz (up to 20V) with accuracy of ± 100 mV.

Output Characteristics

Power level accuracy: ± 1 dB Typically
Option 002 (70 dB Step Attenuator): (83540A, 83545A) ± 0.2 dB/10 dB step

RF power leveling:

Internal: Selected by front panel switch; Refer to chart for figures. Standard

External:

Crystal input: Approximately -20 to -250 mW for specified leveling at rated output; For use with negative polarity detectors such as 780 Series Directional Detectors, 423A/B and 424 Series Crystal detectors.

Power meter input: Switch selects proper compensation for HP 432A/B/C Power Meters.

Indicator: Front panel indicator lights when RF power becomes unleveled. Residual AM in 100 kHz Bandwidth: > 50 dBc

Power Sweep:

Calibrated range: 15 dB
Accuracy: ± 1 dB
Resolution: 0.1 dBm
Slope compensation: Compensates for high frequency power losses in external test sets by attenuation power at lower frequencies.
Calibrated range: up to 1 dB/GHz (10 dB max., typically 15 dB)
Linearity: $< .2$ dB Typical
Resolution: 0.1 dB/GHz

General Specifications

Auxiliary output: (83570A) Rear Panel 9-13.25 GHz fundamental oscillator output, nominally 0 dBm

Weight: 83540A, 83545A: Net 3.8 kg (8.4 lbs); Shipping 7 kg (15.4 lbs). 83570A: Net 5.4 kg (12 lbs); Shipping 8.7 kg (19 lbs).

Ordering Information

	Price
83540A 2-8.4 GHz Plug-in (Internal leveling standard)	\$7500
83545A 5.9-12.4 GHz Plug-in (Internal leveling standard)	\$8250
83570A 18-26.5 GHz Plug-in (Internal leveling standard)	\$9500

Options

002: 70 dB Step Attenuator (83540A, 83545A)	Add \$800
004: Rear Panel RF Output Connector (83540A, 83545A)	Add \$150

	83540A	83545A	83570A
Frequency Characteristics			
Range:	2-8.4 GHz	5.9-12.4 GHz	18-26.5 GHz
Accuracy (25°C \pm 5°C)			
CW Mode:	± 15 MHz	± 20 MHz	± 30 MHz
Typical:	± 3.5 MHz	± 10 MHz	± 20 MHz
All Sweep Modes: (for sweep time > 100 msec)	± 20 MHz	± 35 MHz	± 55 MHz
Stability			
With Temperature:	± 500 kHz/ $^{\circ}$ C	± 700 kHz/ $^{\circ}$ C	± 700 kHz/ $^{\circ}$ C
With 10% Line Voltage Change:	± 20 kHz	± 40 kHz	± 80 kHz
With 10 dB Power Level Change:	± 1 MHz	± 1.5 MHz	± 1 MHz
With 3:1 Load SWR Change:	± 250 kHz	± 250 kHz	± 500 kHz
With Time (after warmup): Typ./10 min.	± 200 kHz	± 200 kHz	± 400 kHz
Residual FM: (in 10 kHz bandwidth, CW mode):	< 9 kHz peak	< 15 kHz peak	< 30 kHz peak
Output Characteristics			
Maximum Leveled Power (25°C \pm 5°C)	> 40 mW	> 50 mW	> 7.9 mW
Opt 002 (70 dB step atten.)	> 32 mW	> 40 mW	
Power Variation (At max. rated power)			
Internally Leveled:	$< \pm 1$ dB	$< \pm .6$ dB	$< \pm 1.4$ dB
Unleveled: Typically	$< \pm 2$ dB	$< \pm 3$ dB	$< \pm 2$ dB
Externally Leveled (Excluding coupler and detector variation):			
Crystal Detector or Power Meter	$< \pm 1$ dB	$< \pm 1$ dB	$< \pm 1$ dB
Spurious Signals: (Below fundamental at specified maximum power)			
Harmonically Related:	> 20 dB (@ 20 mW) > 16 dB (@ 40 mW)	> 17 dB 5.9-7 GHz > 30 dB 7-12.4 GHz	> 25 dB
Non-Harmonics:	> 60 dB	> 60 dB	> 50 dB
Source VSWR: 50 nominal impedance			
Internally leveled:	< 1.6	< 1.6	< 2.5
Unleveled: Typically		< 2.5	
Modulation Characteristics			
External FM			
Maximum Deviations for Modulation Frequencies			
DC to 100 Hz:	± 75 MHz	± 75 MHz	± 75 MHz
100 Hz to 1 MHz:	± 7 MHz	± 7 MHz	± 7 MHz
1 MHz to 2 MHz:	± 5 MHz	± 5 MHz	± 5 MHz
2 MHz to 10 MHz:	± 1 MHz	± 1.5 MHz	± 1.5 MHz
Sensitivity: Nominal			
FM Mode:	-20 MHz/V	-20 MHz/V	-20 MHz/V
Phase-lock Mode:	-6 MHz/V	-6 MHz/V	-6 MHz/V
External AM			
Input Impedance: nominal	5K Ω	5K Ω	5K Ω
Frequency Response: Typical	100 kHz	100 kHz	100 kHz
Range: Typical	15 dB	40 dB	20 dB
Pulse Modulation			
Rise/Fall Time: Typical	20 nsec	15 nsec	10 nsec
Minimum Pulse Width			
Leveled: Typical	1 μ sec	1 μ sec	1 μ sec
Unleveled: Typical	100 nsec	100 nsec	100 nsec
Square Wave Response			
ON/Off Ratio: Typical	> 30 dB	> 40 dB	> 30 dB
Symmetry: Typical	40/60	40/60	40/60
Internal AM:			
Selectable to 1 kHz or 27.8 kHz square wave (Guarantees HP 8755 Frequency Response Test Set compatibility)			
On/Off Ratio:	> 40 dB	> 40 dB	> 25 dB

SWEEP OSCILLATORS

8350 Family: Plug-In Adapter

Model 11869A

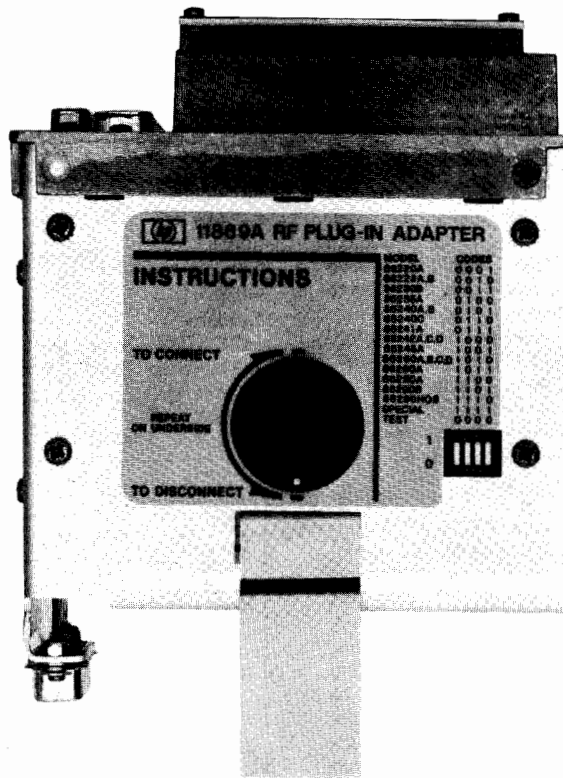

11869A Adapter

The 11869A Adapter provides the electrical and mechanical interface between the 8350A and 86200 series plug-in. All of the 8350A's standard operating features, including HP-IB remote programming, are available. However, specific plug-in functions (output power level, RF on/off, etc.) cannot be controlled or remotely programmed by the 8350A mainframe.

Plug-ins with rear panel RF output

Option 004 allows the adapter to be used in 86200 plug-ins that are equipped with rear panel RF output. Supplied with Option 004 are two pre-shaped, semi-rigid coax cables with the appropriate mating connectors so that the RF output can be extended to the rear panel of the adapter.

Rear Panel Description

On the rear panel of the 11869A are five hole plugs that pop out to allow connections to be made to the rear panel. Four of the holes are for low frequency (small diameter) cables while one is for high frequency (large diameter) RF cable. For user convenience four of the holes are labeled — EXT ALC IN, PULSE IN, FREQ REF AND RF OUT.

Three BNC cables are supplied to extend the plug-in rear panel inputs/outputs to the rear panel of the adapter. A separate cable (BNC/Multi-pin) is provided for connection of the plug-in FM input to the adapter/mainframe.

Plug-ins Compatible with the 11869A Adapter

The 11869A Adapter attaches to the back of the plug-in and is equipped with a switch for setting the specific interface code for the plug-in being used.

The following plug-ins will operate in the 8350A by using the 11869A Adapter.

86220A (0.01–1.3 GHz)	86242A/C/D (5.9–9.0 GHz)
86222A/B (0.01–2.4 GHz)	86245A (5.9–12.4 GHz)
86230B (1.8–4.2 GHz)	86250A/B/C/D (8.0–12.4 GHz)
86235A (1.7–4.3 GHz)	86260A (12.4–18.0 GHz)
86240A/B (2.0–8.4 GHz)	86290A (2.0–18.0 GHz)
86240C (3.6–8.6 GHz)	86290B (2.0–18.6 GHz)
86241C (3.2–6.5 GHz)	86290B H08 (2.0–22 GHz)

Special Plug-ins

For factory modified 86200 series plug-ins with non-standard frequency coverage a special PROM must be inserted in the 11869A Adapter. Consult your local HP Sales and Service Office for further information.

Plug-ins Not Compatible with the 11869A Adapter

The 8621B RF Drawer and 86300 series RF modules are not compatible with the 11869A and will not operate in the 8350A.

Furnished: Three BNC cables for extending plug-in rear panel inputs/outputs to adapter rear panel; BNC/multi-pin cable for connecting plug-in FM input to adapter/mainframe; plug-in handle assembly for simplified installation in the 8350A mainframe.

Ordering Information

11869A Adapter

Option 004: Extension Cables for Plug-ins with Rear Panel RF Output (Opt. 004) Add \$200

Special PROM module: For plug-ins with non-standard frequency coverage. (Consult Sales and Service Office)

Approx. \$50

Price:

\$200

SWEEP OSCILLATORS

Solid State Sweeper Family, 10 MHz to 22 GHz
Model 8620 System

435
hp

- Single-band, straddle-band and broadband plug-ins
- > 10 mW to 22 GHz



8620 System

The Hewlett-Packard 8620 solid state sweeper system offers the flexibility of the 8620C mainframe in addition to a choice of single-band, multiband, straddle-band, and broadband plug-ins. The 8620 system also offers high output with solid state reliability—greater than 10 mW leveled to 22 GHz.

The fundamental oscillators used in the plug-ins and modules are YIG tuned transistor or bulk effect circuits. YIG tuning results in exceptional tuning linearity, low noise, and low spurious content; it also allows frequency modulation at high rates and wide deviations with low distortion.

Typical unlevelled power output

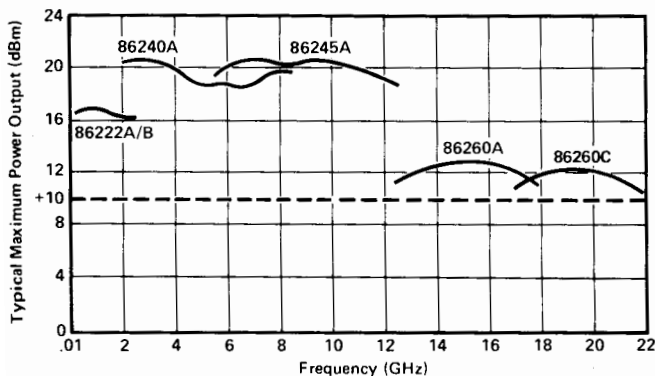

8620C Sweeper Mainframe

The 8620C has many features which are highly useful in stringent applications. With convenient functionally grouped controls and lighted pushbutton indicators the mainframe offers extreme ease of operation and flexibility. In addition, it can be a completely programmable source, either HP-IB or BCD, an indispensable feature for automatic systems and signal simulation applications.

86222A/B and 86290A/B/C Broadband Plug-ins

Now the 10 MHz to 18.6 GHz frequency range can be covered with just two plug-ins—the 86222A/B and 86290A/B/C. Besides their broad frequency range these plug-ins offer many special features including unique crystal markers in the 86222B and better than ± 30 MHz frequency accuracy in a 86290A/B/C even at 18 GHz.

86240A/B Straddle-Band Plug-Ins

Covering more than two octaves of frequency the 86240A and B span 2 to 8.4 GHz with major advances in power output and signal purity. The 86240A offers more than 40 mW leveled output across the full band. The 86240B specifies harmonics of > 45 dBc which can be very important when making measurements across more than one octave.

86200 Series Single-Band Plug-Ins

The 86200 series of plug-ins covers both ends of the frequency spectrum from 10 MHz to 22 GHz with a choice of more than nine plug-ins.

Plug-In Compatibility with 8350A

The entire line of 86200 series plug-ins can be used in the 8350A Sweep Oscillator mainframe with no degradation in performance by using the 11869A Adapter.

Ordering Information

Opt A91: Panel color change to previous standard (olive black/mint gray) for compatibility with existing 8620C/86200 sweepers.

SWEEP OSCILLATORS

8620 Family: Mainframe

Model 8620C

- Optional BCD or HP-IB Programming
- 3 Markers

- 100% ΔF Capability, fully calibrated

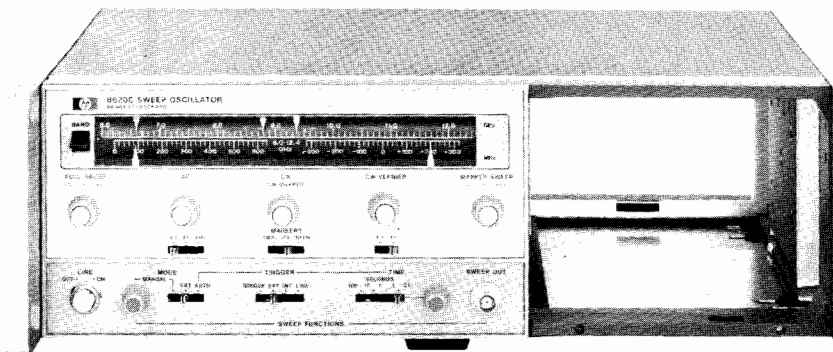

The 8620C offers many features as standard equipment. For example, up to four separate bands and their respective frequency scales can be selected with a band select lever to the left of the dial scale. Pushbuttons, concentrically located in the frequency control knobs, light when actuated to indicate the sweep function in use. The sweep functions available are: FULL SWEEP, MARKER SWEEP, CW/ ΔF and CW. Three markers are available, controlled by the START MARKER, STOP MARKER, and CW MARKER knobs.

The 8620C is fully and continuously calibrated for any ΔF sweep width. The sweep is symmetrical about the CW MARKER setting and three continuously variable ΔF ranges are available by using the range switch below the ΔF knob. This allows calibrated sweep widths of up to 1%, 10% or 100% of full band.

When in CW/ ΔF or CW modes, the CW VERNIER knob allows for excellent frequency resolution. In terms of improved frequency resolution the vernier increases the effective length of the dial scale to 7.5 meters (300 inches).

Another feature is the capability to fully program the sweeper. The standard 8620C includes inputs for band selection, sweep function selection, and analog frequency control. In addition to this, more flexible digital frequency programming options are available to control the 8620C via the HP-IB (Option 011) or by BCD programming (Option 001).

8620C Specifications

Frequency

Frequency range accuracy and linearity: determined by band select lever and RF unit specs.

Sweep Functions

FULL SWEEP: sweeps the full band as determined by the plug-in and the band select lever.

MARKER SWEEP: sweeps from START MARKER to STOP MARKER frequency settings: up to the full range of the plug-in can be set to sweep either up or down in frequency.

ΔF Sweep: sweeps symmetrically upward in frequency, centered on CW setting, CW vernier can be activated for fine control of center frequency.

Width: continuously adjustable and calibrated from zero to 1%, zero to 10%, or zero to 100% of frequency band.

CW operations: single-frequency RF output controlled by CW MARKER knob selected by depressing pushbutton in CW MARKER control.

CW vernier: calibrated directly in MHz about CW setting. CW vernier activated by pushbutton in CW vernier control. Zero to $\pm 0.5\%$ or zero to $\pm 5\%$ of full bandwidth, selectable with front panel switch.

Frequency markers: three constant width frequency markers are fully calibrated and independently adjustable over the entire range in FULL SWEEP function, controlled by START MARKER, STOP MARKER, and CW MARKER controls. In ΔF sweep START and STOP MARKERS are available, and in MARKER SWEEP the CW MARKER is available. Front panel switch provides for the selection of either amplitude or intensity markers (amplitude modulating the RF output or Z-axis modulating the CRT display).

Marker output: rectangular pulse, typically -5 volts peak available from Z-axis BNC connector on rear panel. Source impedance, approximately 1000 ohms.

Sweep Modes (auto, line or externally triggered)

Sweep time: continuously adjustable from 0.01 to 100 seconds.

Single sweep, manual sweep and external sweep control also available.

Sweep output: direct-coupled sawtooth, zero to approximately +10 volts, at front panel BNC connector, concurrent with swept RF output.

Modulation

External AM, FM and phase-lock capability; internal 1000 Hz square wave AM modulation available.

Remote Control

Remote band select: frequency range can be controlled remotely by three binary contact closure lines available at rear panel connector.

Remote Frequency Programming, Opt 001 (BCD) and Opt 011 (HP-IB)

Functions

Band: manual enable or remote control of four bands.

Mode: seven modes are selectable, including digital control in three modes with a resolution of 10,000 points. For more information on remote control of the 8620C refer to Application Note 187-5.

General

Blanking

RF: with blanking switch enabled, RF automatically turns off during retrace, and remains off until start of next sweep.

Display (Z-AXIS/MKR/PEN LIFT Output): direct-coupled rectangular pulse approximately +5.0 volts coincident in time with RF blanking is on rear panel.

Negative (Negative blanking output): direct-coupled rectangular pulse approximately -5.0 volts coincident in time with RF blanking.

Pen lift: for use with X-Y recorders having positive power supplies. Transistor-switch signal is available on Z-AXIS/MKR/PEN LIFT connector. This signal is also available on the programming connector.

Furnished: 2.29 m (7½-foot) power cable with NEMA plug; 2 spare 3 amp fuses; extender board for servicing; calibration scale; incandescent lamp; and 50 pin connector that mates with rear panel programming connector. With Option 011, an HP-IB connector/adaptor are included.

Power: 100, 120, 220, or 240 volts $\pm 5 - 10\%$, 50 to 400 Hz. Approximately 140 watts.

Weight: (not including RF unit): Net, 11.1 kg (24 lb). Shipping 13.4 kg (30 lb).

Size: 132.6 mm H x 425 mm W x 337 mm D (5.29" x 16.75" x 13.25").

Ordering Information

	Price
8620C Sweep Oscillator Mainframe	\$3150
Opt 001: BCD Frequency Programming	add \$650
Opt 011: HP-IB Frequency Programming	add \$950
Opt 908: Rack Flange Kit	add \$22
Opt A91: Panel color change to previous standard (olive black/mint gray) for compatibility with existing 8620C/86200 sweepers.	add \$50

SWEEP OSCILLATORS

8620 Family: 10 MHz to 2.4 GHz Plug-Ins

Models 86222A and 86222B

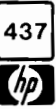

- 10 MHz to 2.4 GHz in ONE, CONTINUOUS sweep
- Internally leveled FLATNESS ± 0.25 dB over full range

- 1, 10, and 50 MHz crystal marker combs with 86222B
- Marker accuracy even in CW with 86222B

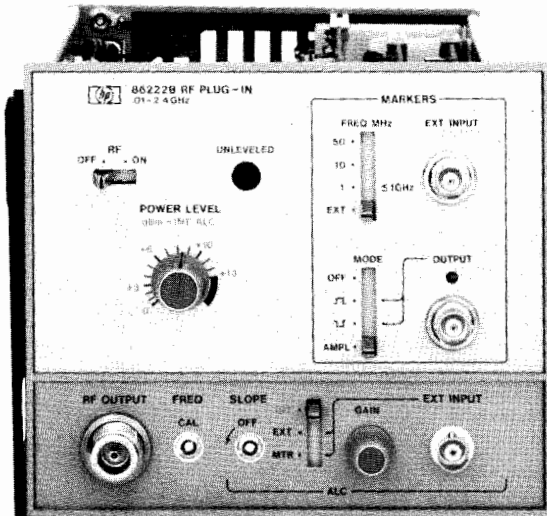

86222B

The 86222A and 86222B RF plug-ins can provide CW or continuous swept 10 MHz to 2.4 GHz frequency coverage. Power output is calibrated from 0 to +13 dBm in 1 dB increments with ± 0.25 dB flatness and excellent linearity (2 MHz) over the entire 0.01 to 2.4 GHz range. For applications demanding precise frequency identification, the 86222B offers a crystal marker system which provides a comb of markers at 1, 10 or 50 MHz. Markers may be displayed as intensified spots on a CRT or as amplitude dips on the RF output (often useful for XY recordings). In addition, when the output frequency is coincident with a 50, 10 or 1 MHz comb of the internal crystal oscillator, a front panel LED lights for independent CW frequency calibration (75 kHz accuracy at 1 GHz). For scalar measurements, the 27.8 kHz square wave modulation from the HP 8755 Frequency Response Test Set is accepted directly through the external AM input. For phase/magnitude network analysis the interfacing between the sweeper and the 8410B Network Analyzer permits the 8410B to automatically phase-lock over multi-octave sweeps.

Specifications with Plug-in Installed in an 8620C Mainframe

Frequency Characteristics

Range: 10 MHz to 2.4 GHz.

Accuracy (25°C)

CW mode: ± 10 MHz.

Remote programming: typically ± 1.5 MHz.

All sweep modes: ± 15 MHz (> 100 msec sweep time). Accuracy of 86222B may be enhanced to better than ± 200 kHz through use of crystal markers.

Linearity: typically ± 2 MHz.

Stability

With temperature: ± 500 kHz/ $^{\circ}$ C.

With 10% line voltage change: ± 20 kHz.

With 10 dB power level change: ± 100 kHz.

With 3:1 load SWR, all phases: ± 10 kHz.

With time (after 1-hour warm-up): typically ± 100 kHz/10 min.

Residual FM: (10 kHz bandwidth; FM switch in NORM; CW Mode): < 5 kHz peak.

Output Characteristics

Maximum leveled power (25°C): > 20 mW (+13 dBm); typically $> +15$ dBm.

Power level accuracy (internal leveling only): ± 1 dB.

Attenuator Opt 002: add ± 0.2 dB/10 dB step.

Power Variation (at max. rated power)

Internally leveled

0.01 to 2.4 GHz: ± 0.25 dB.

Stability with temperature: typically ± 0.02 dB/ $^{\circ}$ C.

Externally leveled (excluding coupler and detector variation)

Crystal detector: (-10 to -100 mV at rated output): ± 0.1 dB.

Power meter (with HP 432A/B/C Series power meters): ± 0.1 dB.

Residual AM in 100 kHz BW: > 50 dBc.

Spurious signals: (below fundamental)

Harmonics: > 25 dB at +13 dBm; typically > 30 dB at +10 dBm.

Non-Harmonics

0.01 to 2.3 GHz: > 30 dB at +13 dBm; typically > 40 dB at +10 dBm.

2.3 to 2.4 GHz: > 25 dB at +13 dBm; typically > 35 dB at +10 dBm.

Broadband noise in 100 kHz bandwidth: typically < -70 dBm.

Impedance: 50 Ω nominal.

SWR: < 1.5 internally leveled.

Slope control: allows variable compensation for frequency dependent losses in test set-up.

RF output connector: type N female.

Modulation Characteristics

External AM

Input impedance: approximately 10 k Ω .

Frequency response: typically 150 kHz.

Square wave response:

On/Off ratio: > 30 dB.

Symmetry: 40/60, for > 10 dBm output power.

Attenuation for +5 V input: > 30 dB.

Internal AM

1 kHz square-wave On/Off ratio: > 30 dB.

RF blanking On/Off ratio: > 30 dB.

External FM

Maximum deviations for modulation frequencies

DC to 100 Hz: ± 75 MHz.

100 Hz to 1 MHz: ± 5 MHz.

1 MHz to 2 MHz: ± 2 MHz.

Sensitivity (typically)

FM mode: -20 MHz/V.

Phase-lock mode: -6 MHz/V.

Crystal Marker Capabilities (86222B Only)

Internal crystal markers: harmonic markers of 10 and 50 MHz usable over full 0.01 to 2.4 GHz range and 1 MHz markers usable 0.01 to 1 GHz. Positive (+) or negative (-) voltage output pulses can be selected to Z-axis intensify a scope trace; or RF amplitude pips can be selected (at maximum sweep speed pulse width optimized for approximately 10 markers/sweep).

Accuracy of center frequencies (25°C): $\pm 5 \times 10^{-6}$.

Typical marker width around center frequency

1 MHz markers: ± 75 kHz.

10 MHz markers: ± 200 kHz.

50 MHz markers: ± 300 kHz.

Temperature stability: typically $\pm 2 \times 10^{-6}$ / $^{\circ}$ C.

Marker output mode: nominally > 3 V.

mode: nominally -4 to -9 V, internally adjustable.

Amplitude mode: typically 0.5 dB, internally adjustable.

General

Weight: net, 2.5 kg (5.5 lb). Shipping 4 kg (9 lb).

Ordering Information

86222A 0.01-2.4 GHz RF Plug-In (internal leveling standard)

Price

\$5100

86222B 0.01-2.4 GHz RF Plug-In with Crystal and External Markers (internal leveling standard)

\$6150

Opt 002: 70 dB Step Attenuator (10 dB steps)

add \$600

Opt 004: Rear Panel RF Output

add \$150

Opt A91: Panel color change to previous standard (olive black/mint gray) for compatibility with existing 8620C/86200 sweepers.

add \$25

SWEEP OSCILLATORS

8620 Family: Broadband Plug-Ins

Models 86290A and 86290B

- +13 dBm 2 to 18.6 GHz with 86290C
- 2 to 22GHz with Option H08

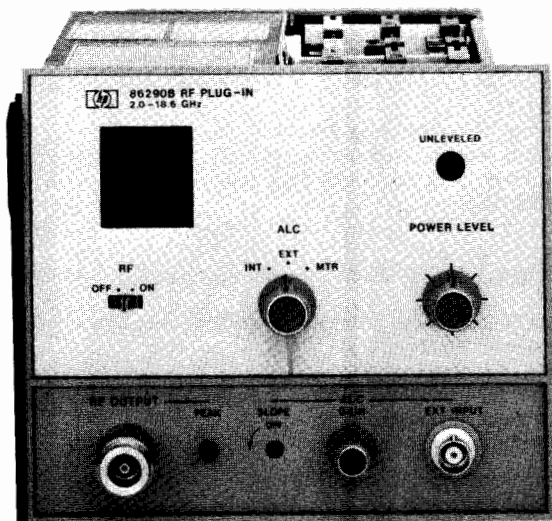

86290B

The 86290A/B/C broadband plug-ins set new standards in sweeper performance and versatility. For broadband testing, a continuous sweep from 2 to 18.6 GHz (18 GHz with the 86290A) is provided. In addition, higher frequency resolution is achieved by covering the 2 to 18.6 GHz range in three individual bands of 2 to 6.2, 6 to 12.4, 12 to 18.6 (or 18 GHz). The 86290C offers outstanding electrical performance producing >20 mW swept output over the 2 to 18.6 GHz range along with excellent linearity and low spurious and harmonic content. For scalar measurements the 27.8 kHz square wave modulation from the HP 8755 Frequency Response Test Set is accepted directly through the EXTERNAL AM input. When performing phase/amplitude network analysis the interfacing between the sweeper and the HP 8410B Network Analyzer permits the 8410B to automatically phase lock over multi-octave sweeps for continuous swept 2 to 18.6 GHz phase and amplitude measurements.

Specifications

with Plug-in Installed in an 8620C Mainframe

Frequency Characteristics

	Band 1	Band 2	Band 3	Band 4
Range: (GHz) 86290A	2-6.2	6-12.4	12-18	2-18
86290B/C	2-6.2	6-12.4	12-18.6	2-18.6
Accuracy (25°C)				
CW mode (or > 100 ms sweep time): (MHz)	±20	±30	±30	±100
Remote programming: (typ.)	±2.5	±2.5	±3.5	—
All sweep modes: (MHz)	±30	±30	±30	±80
Marker: (MHz)	±30	±30	±30	±80
Linearity (MHz) typ.:	±8	±8	±8	±30
Frequency Stability				
With temperature: (MHz/°C)	±0.5	±1.0	±1.5	±2.0
With 10% line voltage change: (kHz)	±100	±100	±100	±100
With 10 dB power level change: (MHz)	±0.6	±1.2	±1.8	±1.8
With 3:1 load VSWR, all phases: (kHz)	±100	±200	±300	±300
With time (in 10 minute period after 30 minute warmup): typically (kHz)	±300	±600	±900	±900
Residual FM (10 kHz bandwidth CW mode): (kHz peak)	<10	<20	<30	<30

Output Characteristics

Maximum leveled power (25°C):

- 86290A: +7 dBm, 2 to 18 GHz. (Opt. 004: +6.5 dBm)
- 86290B: +10 dBm, 2 to 18.6 GHz. (Opt. 004: +9.5 dBm)
- 86290C: +13 dBm, 2 to 18.6 GHz. (Opt. 004: +12 dBm)

Power level control range: >10 dBm

	Band 1	Band 2	Band 3	Band 4
Power Variation (Max Rated Pwr)				
Internally leveled: (dB)	±0.7	±0.7	±0.8	±0.9
Externally leveled (excluding coupler and detector variation)				
Crystal detector: -20 to -250 mV for specified leveling at rated output: (dB)	±0.15	±0.15	±0.15	±0.15
Power meter: internal leveling amplifier with compensation for HP models 432A/B/C provided: (dB)	±0.15	±0.15	±0.15	±0.15
With temperature, typically (dB/°C)	±0.1	±0.1	±0.1	±0.1

Residual AM in 100 kHz BW: >55 dBc.

Spurious signals

Harmonically related signals: >25 dBc.

Non-harmonics: >50 dBc.

Impedance: 50Ω nominal.

SWR: <1.9 internally leveled.

RF output connector: type N female.

Modulation Characteristics

External AM

Input impedance: approximately 1000Ω.

Frequency response: typically 300 kHz leveled.

Square wave response

On/Off ratio: >30 dB.

Symmetry: 40/60.

Attenuation for +5V input: >30 dB.

Internal AM (1000 Hz):

Square-wave On/Off ratio: >25 dB.

RF blanking On/Off ratio: >30 dB.

External FM:

Maximum deviations for modulation frequencies

DC to 100 Hz: ±75 MHz.

100 Hz to 2 MHz: ±5 MHz.

Sensitivity (typically)

FM mode: -20 MHz/V.

Phase-lock mode: -6 MHz/V.

General

Sweep time (min): 10 ms single bands. 60 ms on 2 to 18 GHz band.

Auxiliary output: rear panel 2 to 6.2 GHz fundamental oscillator output, nominally -10 dBm.

Slope control: front panel control allowing compensation for frequency dependent test setup losses.

Peak control: front panel control for peaking power over desired frequency range.

Frequency reference output: nom. 1 V/GHz (2-18.6 volts) ±35 mV rear panel BNC output.

Weight: net, 4.4 kg (9.6 lb). Shipping, 5.9 kg (13 lb).

Ordering Information

86290A 2 to 18 GHz +7 dBm (5mW) plug-in (internal leveling standard) \$14,250

86290B 2 to 18.6 GHz +10 dBm (10 mW) plug-in (internal leveling standard) \$16,250

86290C 2 to 18.6 GHz +13 dBm (20 mW) plug-in (internal leveling standard) \$18,750

Opt 004: rear panel RF output: add \$150

Opt 005: APC-7 RF output connector: add \$75

Opt A91: Panel color change to previous standard (olive black/mint gray) for compatibility with existing 8620C/86200 sweepers. N/C

Opt H08: 2 to 22 GHz operation, 86290B add \$3000

SWEEP OSCILLATORS

8620 Family: Straddle Band Plug-Ins

Models 86240A, 86240B, and 86240C



- 45 dBc harmonics with 86240B
- Up to 40 mW output power with 86240A
- MLA compatibility with 86240C

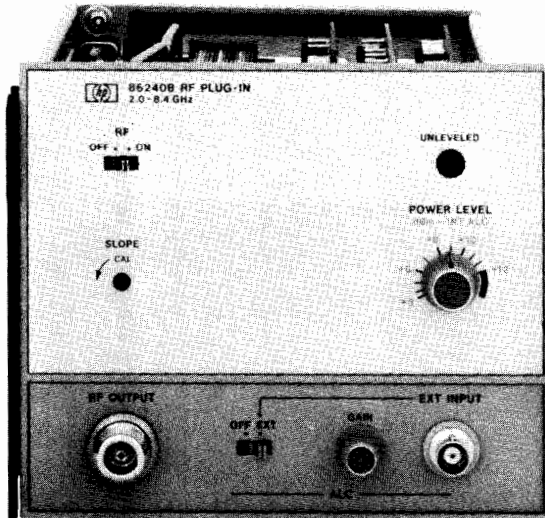

86240B

86240A: 2-8.4 GHz with 40 mW

The 86240A features up to 40 mW of output power, competitive harmonics, at an attractive price. With the internal leveling option the 86240A also provides calibrated output power and slope control.

86240B: 2-8.4 GHz with 45 dBc Harmonics

The 86240B was designed for low harmonic distortion having narrow-band harmonic performance of at least 45 dBc. Internal leveling of ± 0.5 dB is standard along with slope control as well as up to 20 mW of output power.

86240C RF Distortion analysis of mW links: 3.6-8.6 GHz

The 86240C can be used for MLA Upconverter Simulation. It is optimized for group delay of less than 1 ns peak-to-peak over 30 MHz, linearity better than 0.5% and power output up to 40 mW. It

has 10 MHz FM bandwidth, flat to ± 1.5 dB for noise loading applications, power control and optional leveling. In addition, to being optimized for communications systems applications the 86240C is an ideal general purpose microwave source. For further information on MLA Upconverter Simulation refer to the Telecommunications Test Equipment section on page 637.

Specifications

with plug-in installed in an 8620C mainframe

Frequency Characteristics

Linearity: typically $\pm 0.1\%$.

Residual FM (in 10 kHz bandwidth, FM switch in NORM, CW Mode): < 9 kHz peak.

Reference output: DC-coupled voltage proportional to RF frequency, voltage approximately 1 V/GHz.

Output Characteristics

RF Power Leveling

Internal, option 001: Selected by front panel switch; refer to RF plug-in specifications. (Standard on 86240B)

Source SWR: 50 Ω nominal impedance

Internally leveled (Option 001): < 1.6 SWR.

Unleveled: Typically 3 SWR.

RF output connector: Type N female.

86240C Modulation Characteristics

External FM (Maximum deviation for modulation frequencies)

DC to 100 Hz: ± 1.5 MHz

90 kHz to 10 MHz: ± 1.5 MHz

Frequencies response, DC to 10 MHz: ± 1.5 dB

Nominal sensitivity

FM mode: ± 20 MHz/volt

Upconverter mode: ± 20 MHz/volt

General

Weight: Net, 2.3 kg (5 lb). Shipping, 3.2 kg (7 lb).

Options

002: 70 dB Step Attenuator

004: Rear Panel RF Output

Opt A91: Panel color change to previous standard (olive black/mint gray) for compatibility with existing 8620C/86200 sweepers.

Price
add \$550
add \$150

	86240A	86240B	86240C
FREQUENCY			
Frequency Range (GHz):	2.0-8.4	2.0-8.4	3.6-8.6
Frequency Accuracy: (25°C)			
CW Mode (MHz)	± 25	± 25	± 25
CW Remote Programming typically (MHz):	± 3.5	± 3.5	± 3.5
All Sweep Modes (for sweep time > 100 ms) (MHz):	± 40	± 50	± 35
POWER OUTPUT			
Maximum Leveled Power (25°C) (mW):	> 40	> 20	> 40
With Option 002 (mW):	> 32	> 16	> 32
Power Variation: (At Max Rated Power)			
Unleveled (Typically) (dB):	$< \pm 2$		$< \pm 2$
Internally Leveled (Opt 001) (dB):	$< \pm 1$	$< \pm 0.5$	$< \pm 0.8$
Externally Leveled (Excluding Coupler and Detector Variation) Crystal Detector and Power Meter (dB):	$< \pm 0.1$	$< \pm 0.1$	$< \pm 0.1$
Spurious Signals: (dB below fundamental at specified maximum power)			
Harmonics:	> 20 (20 mW) > 16 (40 mW)	> 45	> 20 (20 mW) > 16 (40 mW)
Nonharmonics:	> 60	> 60	> 60
PRICE			
Plug-in:	\$5050	\$6700	\$5450
Opt 001 (Internal Leveling):	add \$650	Included	add \$650

SWEEP OSCILLATORS

8620 Family: Single Band Plug-ins

Model 86200 Series and 11869A Adapter

- 10 MHz to 22 GHz coverage
- >50 mW from 5.9 to 12.4 GHz
- Compatible with 8350A Mainframe via 11869A Adapter

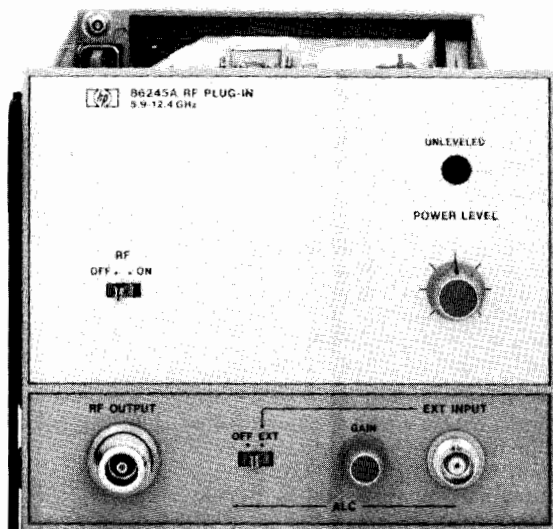

86245A

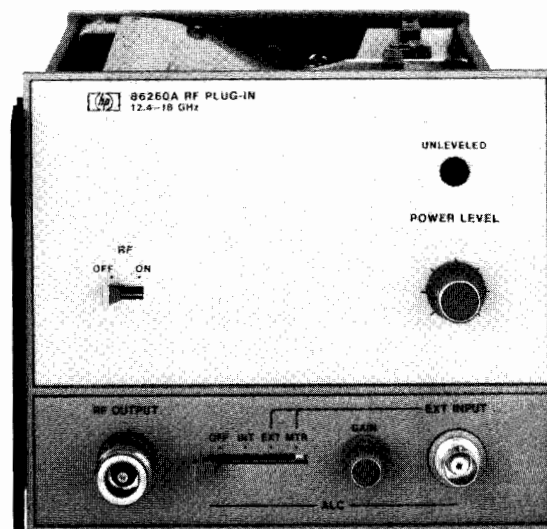

86260A

86200 Series

The 86200 series plug-ins feature a wide choice of bandwidths and power specifications for covering the 10 MHz to 22 GHz frequency range. The 86222A/B 10 MHz to 2.4 GHz plug-ins, the 86240A/B/C 2 GHz to 8.6 GHz plug-ins, and the 86290A/B 2 GHz to 18.6 GHz plug-ins cover multi-octave frequency ranges with exceptional frequency precision and RF output characteristics. See preceding pages for specifications on these plug-ins. For octave band applications, smaller range plug-ins covering, for instance, 5.9 GHz to 12.4 GHz are available with optional capability to operate as up-converters for MLA measurements.

11869A Adapter

The 86200 series can be used in the 8350A Sweep Oscillator mainframe with the addition of the 11869A Adapter. The 11869A provides the electrical and mechanical interface between the 86200 plug-in and the 8350A so that digital control of the plug-in is possible. All of the performance and features of the 8350A Sweep Oscillator Mainframe are available when using the 86200 plug-ins and 11869A Adapter. For more information on the 11869A see page 434.

Specifications

With plug-in installed in an 8620C Mainframe

Frequency linearity: typically $\pm 1\%$.

Frequency reference output: typically 1 V/GHz dc-coupled voltage is available for referencing or phase-locking external equipment to the plug-in or for multi-octave operation with an 8410B.

RF power leveling: internal dc-coupled leveling amplifier and PIN modulator provided.

Internal, Opt 001: selected by front panel switch; refer to RF plug-in specifications (standard on 86220A).

External

Crystal input: approximately -20 to 250 mV for specified leveling at rated output; for use with negative polarity detectors such as 780

Series Directional Detectors, 423A/B and 8470 Series Crystal Detectors.

Power meter input: leveling amplifier with compensation for HP 432A power meter included internally in all plug-ins except the 86230B and 86241A which require the use of an 8404A Leveling Amplifier and the EXT AM input on the 8620 Mainframe.

Indicator: front panel indicator lights when RF power level is set too high to permit leveling over entire selected sweep range or when operating in unleveled mode.

Residual AM in 100 kHz bandwidth: >50 dB below fundamental at specified maximum power.

External AM

Frequency response: typically dc to 100 kHz unleveled, dc to 50 kHz leveled (at maximum leveled power).

Input impedance: approximately 5000 ohms.

RF output connector: type N Female.

8350A Compatibility: The 11869A Adapter provides the electrical and mechanical interface so that the 86200 series plug-ins can be used in the 8350A Sweep Oscillator mainframe. For more information see the section on 11869A Adapter page 434.

Weight: net, 2.3 kg (5 lb). Shipping, 3.2 kg (7 lb).

Options

001: Internal leveling. Refer to RF plug-in specifications.

002: 70 dB attenuator in 10 dB steps, available in 86220A and 86235A

004: rear panel RF output

005: APC-7 RF output connector available on 86260A

Price

See model

number

add \$400

or \$550

respectively

add \$150

add \$75

Upconverter simulation options: options are available which guarantee compatibility with the HP Microwave Link Analyzer. For further information on these plug-ins refer to the Telecommunications Test Equipment Section beginning on page 637.

Single Band Plug-ins

Refer also to broadband models 86222A/B (0.01-2.4 GHz), 86240A/B/C (2-8.6 GHz), and 86290A/B (2-22 GHz)

Specifications with plug-in installed in 8620C	86220A	86230B	86235A	86241A	86242D	86245A	86250D	86260B	86260A	86260C
Frequency range¹ (GHz):	0.01-1.3	1.8-4.2	1.7-4.3	3.2-6.5	5.9-9.0	5.9-12.4	8.0-12.4	10.0-15.5	12.4-18.0	17.0-22.0
Frequency accuracy										
CW mode (MHz):	±10	±15	±20	±30	±35	±40	±40	±50	±50	±50
Remote programming typically (MHz):	±7.5	±2.5	±2.5	±10.5	±5.5	±10.5	±8.5	±5.5	±5.5	±6.8
All sweep modes (sweep time >100 ms) (MHz):	±15	±20	±30	±33	±40	±50	±50	±70	±70	±70
Stability:										
With Temperature:	±600 kHz/°C	±500 kHz/°C	±500 kHz/°C	±650 kHz/°C	±750 kHz/°C	±1.2 MHz/°C	1.2 MHz/°C	±5.4 MHz/°C	±5.4 MHz/°C	±5.4 MHz/°C
With 10% Line Voltage Change:	±20 kHz	±20 kHz	±40 kHz	±30 kHz	±40 kHz	±40 kHz	±40 kHz	±180 kHz	±180 kHz	±180 kHz
With 10 dB Power Level Change:	±20 kHz	±1 MHz	±1 MHz	±1 MHz	±1.5 MHz	±1.5 MHz	±1.5 MHz	±6 MHz	±6 MHz	±6 MHz
With 3:1 Load SWR Change, all Phases:			±250 kHz		±250 kHz	±250 kHz	±250 kHz			
With Time (after warm-up): Typ/10 min.	±200 kHz	±200 kHz	±200 kHz	±200 kHz	±600 kHz	±200 kHz	±600 kHz		±450 kHz	
Residual FM: (in 10 kHz bandwidth CW mode):	<5 kHz peak	<7 kHz peak	<7 kHz peak	<7 kHz peak	<15 kHz peak	<15 kHz peak	<15 kHz peak	<25 kHz peak	<25 kHz peak	<25 kHz peak
Residual FM (10 kHz BW, FM switch in NORM) CW mode (kHz peak):	<5	<7	<7	<7	<15	<15	<15	<25	<25	<25
Maximum leveled power¹ (mW):	10	>10	>40	>6.3	>10	>50	>10	>10	>10	>10
Power variation										
Internally leveled (dB):	<±0.5	<±1.2	<±0.8	<±0.8	<±0.5	<±0.6	<±0.5	<±4	<±0.7	<±4
Externally leveled (dB) (excluding coupler & detector variation):	N/A	<±0.1	<±0.1	<±0.1	<±0.1	<±0.1	<±0.1	<±0.1	<±0.1	<±0.1
Spurious signals:										
(dB below fundamental, at specified max power)										
Harmonics:	>25	>20	>20	>16(3.2-3.8 GHz) >20(3.8-6.5 GHz)	>30	>17(5.9-7 GHz) >30(7-12.4 GHz)	>30	>25	>25	>25
Nonharmonics:	>50	>60	>60	>60	>60	>60	>60	>60	>50	>50
Source SWR: (50Ω nom, Internally leveled)	<1.3	<1.6	<1.6	<1.6	<1.6	<1.6	<1.6		<1.6	
External FM:										
Max deviations (MHz) for modulation frequencies:										
DC-100 Hz:	±15	±25	±75	±25	±150	±150	±150	±75	±75	±75
DC-1 MHz:	±0.5	±2	±5	±2	±7	±7	±7	±5(DC-200 kHz)	±5(DC-200 kHz)	±5(DC-200 kHz)
Sensitivity (nom, MHz/V):	+3.5	-4	-20/-6	-6	-20/-6	-20/-6	-20/-6	-20/-6	-20/-6	-20/-6
AM: Internal 1 kHz Square wave On/Off ratio & EXT AM sensitivity To -10 V (dB):	>35	>25	>30	>25	>40	>40	>40	>25	>25	>25
EXT AM Response compatible with 8755 Mod drive signal:	No	No	Yes	No	Yes	Yes	Yes	No	No	No
Price:										
Plug-in:	\$3300	\$2950	\$3700	\$3150	\$3450	\$5950	\$3550	\$5100	\$4350	\$7600
Opt 001 (int. lev):	Included	+\$390	+\$550	+\$390	+\$500	+\$500	+\$500	\$750	+\$550	

1. Special frequency bands and high power outputs available on request.

SWEEP OSCILLATORS

8690 Sweeper Family, 400 kHz to 50 GHz

Model 8690 System

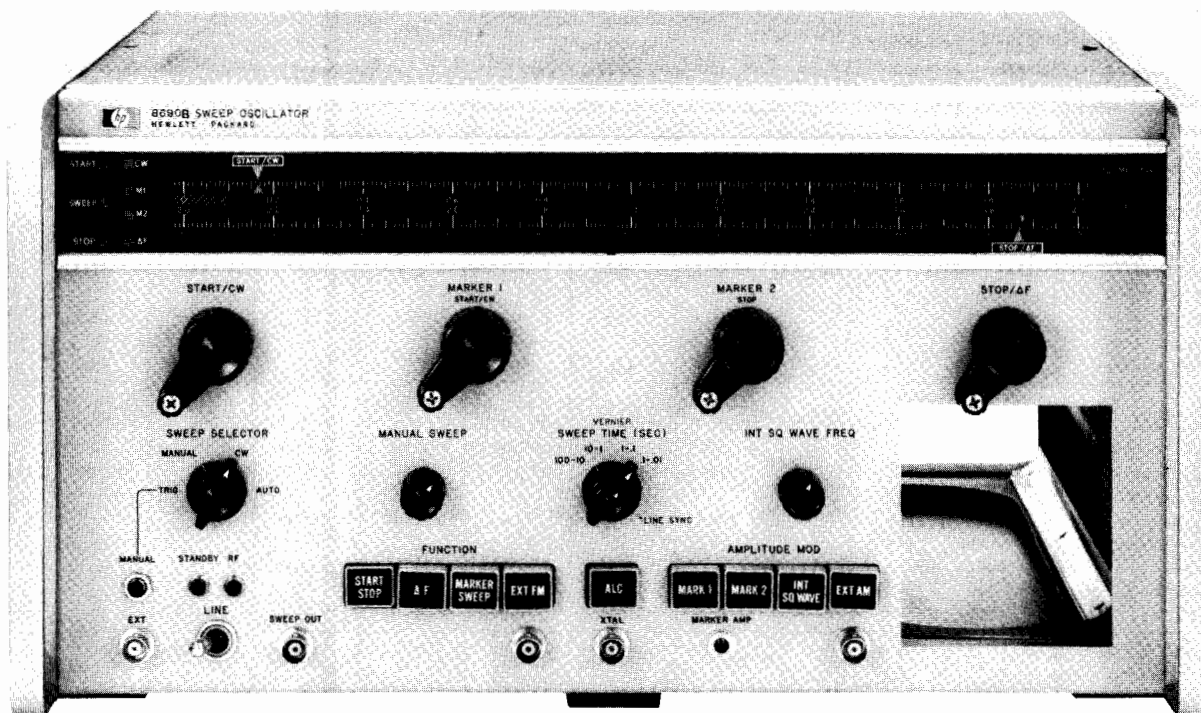

8690B

8690 System

The familiar 8690 BWO sweeper family offers exceptional value in performance, operation and versatility. With the ability to accept both BWO and solid state plug-ins, the 8690 mainframe allows BWO coverage where necessary, and more reliable, high performance solid state coverage at lower frequencies.

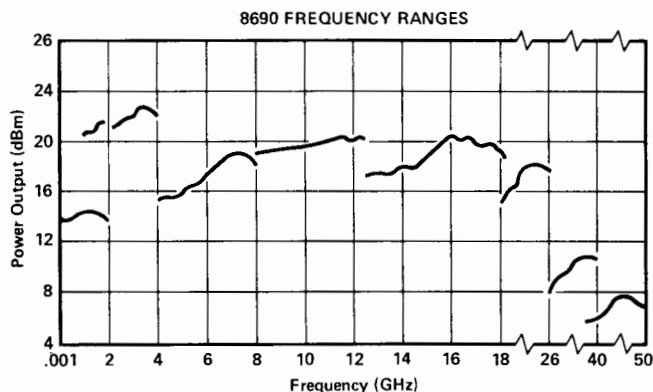

8690B Mainframe Specifications

Sweep Functions

START/STOP sweep: sweeps from "start" to "stop" frequency setting. Both settings continuously adjustable over entire frequency range.

MARKER sweep: sweeps from "Marker 1" to "Marker 2" frequency setting. Both settings continuously adjustable over entire frequency range and accurate to 1% of full scale for all RF units.

ΔF sweep: sweeps upward in frequency, centered on CW setting. Width is continuously adjustable from zero to 10% of the frequency band and is calibrated in MHz. Accuracy is $\pm 1\%$ of maximum ΔF plus $\pm 10\%$ of ΔF being swept.

CW operation: single-frequency RF output selected by START/CW or MARKER 1 control, depending on sweep function selected.

Sweep Modes

Auto, manual, and triggered sweep modes; sweep indicator lights during each sweep.

Sweep time: continuously adjustable in four decade ranges, 0.01 to 100 seconds.

Sweep output: direct-coupled sawtooth, zero to approximately +15 V, concurrent with swept RF output, regardless of sweep width or direction.

General

Frequency markers: two markers independently adjustable over entire frequency range accurate to 1% of full scale. Amplitude is adjustable from front panel. A -5 V triangular pulse is available as an intensity marker on the rear panel.

Internal AM: square wave modulation continuously adjustable from 950 to 1050 Hz.

External AM: frequency response dc to 350 kHz unlevelled, dc to 50 kHz levelled.

Blanking: both negative (-4 V) and RF blanking available along with pen lift output.

Weight: net, 23.9 kg (53 lb). Shipping, 32 kg (71 lb).

Size: 222 mm H x 425 mm W x 467 mm D (8.75" x 16.75" x 18.38").

8690B Sweeper Mainframe

\$4500

- Solid state plug-ins
- Both pin and grid leveled BWO plug-ins
- Frequency coverage to 50 GHz

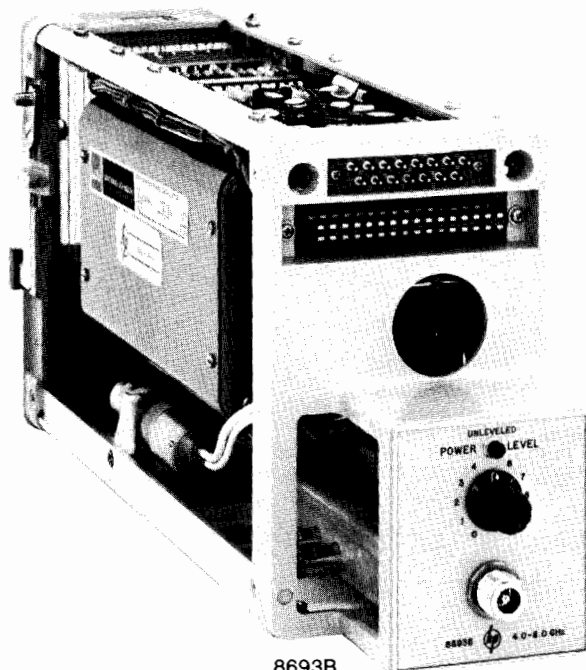

8693B



8709A



8404A

Solid State and BWO Plug-ins

Solid state plug-ins from 400 kHz to 4 GHz are available for the 8690 mainframe. BWO replacement is both expensive and inconvenient. Solid state plug-ins not only offer high reliability, but also provide low residual FM and good spectral purity. This capability allows one mainframe to cover high frequency, high power BWO applications, yet facilitate high performance, longer life solid state coverage of lower frequencies. There are two solid state plug-ins. The 8698B covers 400 kHz to 110 MHz while the 8699B plug-in has a 100 MHz to 4 GHz range.

Both grid leveled and pin leveled BWO plug-ins are available covering 1 to 50 GHz. Grid leveled BWO oscillators achieve power and leveling control by varying bias on the BWO grid. Although some degradation in frequency performance specifications is seen by this method, grid leveling provides an economical means of power control and delivers higher power output since there are no components (pin modulators) between BWO and front panel output.

PIN leveled BWO plug-ins offer superior frequency stability characteristics. As in all solid state plug-ins, leveling is accomplished through use of a pin diode modulator between oscillator and output. Use of the pin allows the oscillator to work at constant bias and into a constant impedance load, resulting in very low residual FM and very little frequency pulling. Pin leveling also results in a better source impedance match. Specifications on the following page.

Common Specifications: BWO Plug-ins

Warranty: all BWO's are unconditionally warranted for one year.

Spurious signals: harmonics, >20 dB below CW output; nonharmonics, >40 dB below CW output.

Residual AM: >40 dB below CW output.

Magnetic shielding: all plug-ins except the 8691A/B have shielded BWO's.

Reference output: dc voltage proportional to frequency output ≈ 40 V/octave.

Leveling indicator: front panel light indicates unlevelled operation.

Power variation

Unlevelled: <10 dB over full band.

Externally leveled: ± 0.2 dB for A units.

± 0.1 dB for B units.

Frequency stability with temperature: $\pm 0.01\%/^{\circ}\text{C}$.

Weight

8691-8692: net, 7.7 kg (17 lb). Shipping, 11.3 kg (25 lb).

8693-8697: net, 5.4 kg (12 lb). Shipping, 9 kg (20 lb).

8698-8699: net, 5.0 kg (11 lb). Shipping, 8.6 kg (19 lb).

8709A Phase Lock Synchronizer

The 8709A Synchronizer is a phase comparator designed to stabilize the frequency of both HP BWO and solid state sources by phase locking to a reference oscillator. Under these conditions system stability is determined primarily by the stability of the reference oscillator. Phase lock capability is standard on solid state plug-ins from 0.01 to 22 GHz. Order Option J54 for BWO plug-ins. Information on complete phase-locked systems available on request.

Specifications

Input frequency: the locking frequency of the 8709A is 20 MHz. This signal is obtained by multiplying and mixing the reference oscillator with the microwave signal.

Sensitivity: -65 dBm.

Minimum output voltage: high level ± 12.0 V dc; low level ± 8.0 V dc.

Modulation sensitivity: 8690 BWO Option J54 plug-ins, 0.5 to 6.0 MHz/V. 8620 solid state plug-ins 6.0 MHz/V.

Weight: net, 4.5 kg (10 lb). Shipping, 5.3 kg (11.6 lb).

8404A Power Meter Leveling Amplifier

The 8404A Leveling Amplifier permits the 431B/C or 432A/B/C Power Meter to level both the 8620 and 8690 sweeper plug-ins. RF output is leveled to ± 0.5 dB or less when connected to the AM input of the sweeper.

Ordering Information

8404A Power Meter Leveling Amplifier

Price

\$850

Opt 001: 4 line BCD level control

add \$210

8709A Phase-Lock Synchronizer

\$1600

SWEEP OSCILLATORS

8690 Sweeper Family (cont.)

PIN Leveled Solid State Plug-ins

Frequency Range	Model Number	Maximum Leveled Power	Frequency Accuracy	Frequency Stability With		Residual FM ²	Int. Leveling Power Variation	Connector	Price
				Temperature	10 dB Power Level Change				
0.4–11 MHz	8698B	>20 mW	$\pm 1\% \pm 50\text{kHz}$	$\pm 0.05\%/^{\circ}\text{C}$	—	<300 Hz rms	$\pm 0.3\text{ dB}$	BNC ¹	\$3550
11–110 MHz		>20 mW	$\pm 1\% \pm 500\text{kHz}$	$\pm 0.05\%/^{\circ}\text{C}$	—	<500 Hz rms	$\pm 0.3\text{ dB}$		
0.1–2 GHz	8699B	>20 mW	$\pm 10\text{ MHz}$	$\pm 750\text{ kHz}/^{\circ}\text{C}$	<100 kHz	<3 kHz rms	—	Type N	\$7500
2–4 GHz		>6 mW	$\pm 10\text{ MHz}$	$\pm 750\text{ kHz}/^{\circ}\text{C}$	<500 kHz	<3 kHz rms	—		

1. 8698B Opt 001: 75 Ω BNC output. Add \$55.

2. Residual FM measured with 10 kHz bandwidth cw mode

Grid and PIN Leveled BWO Plug-ins

Frequency	Model Number	Power Control	Maximum Leveled Power	Frequency Accuracy	Freq. Stability With Power Level Change ¹	Residual FM Peak ²	Option 001 Int. Leveling Power Variation	Connector	Price	Option 001 Int. Leveling Price-Add
1.0–2.0 GHz	8691A	GRID	>100 mW	$\pm 1\%$	<20 MHz	<30 kHz	$\pm 0.4\text{ dB}$	Type N	\$5800	\$360
	8691B	PIN	>70 mW	$\pm 10\text{ MHz}$	$\pm 500\text{ kHz}$	<10 kHz	—	Type N	\$6500	—
1.4–2.5 GHz	8691A Opt. 200	GRID	>100 mW	$\pm 1\%$	<30 MHz	<30 kHz	—	Type N	\$6080	—
1.7–4.2 GHz	8692B Opt. 100	PIN	>15 mW	$\pm 25\text{ MHz}$	$\pm 4\text{ MHz}$	<20 kHz	—	Type N	\$7250	—
2.0–4.0 GHz	8692A	GRID	>70 mW	$\pm 1\%$	<40 MHz	<30 kHz	$\pm 0.4\text{ dB}$	Type N	\$5500	\$360
	8692B	PIN	>40 mW	$\pm 20\text{ MHz}$	4 MHz	<15 kHz	—	Type N	\$6500	—
3.5–6.75 GHz	8693A Opt. 200	GRID	>40 mW	$\pm 1\%$	<80 MHz	<50 kHz	—	Type N	\$6900	—
3.7–8.3 GHz	8693B Opt. 100	PIN	>5 mW	$\pm 45\text{ MHz}$	$\pm 1\text{ MHz}$	<20 kHz	$\pm 0.4\text{ dB}$	Type N	\$5800	\$390
4.0–8.0 GHz	8693A	GRID	>30 mW	$\pm 1\%$	<80 MHz	<50 kHz	$\pm 0.5\text{ dB}$	Type N	\$4900	\$390
	8693B	PIN	>15 mW	$\pm 40\text{ MHz}$	$\pm 1\text{ MHz}$	<15 kHz	$\pm 0.4\text{ dB}$	Type N	\$5800	\$390
7.0–11.0 GHz	8694A Opt. 200	GRID	>25 mW	$\pm 1\%$	<160 MHz	<60 kHz	$\pm 0.75\text{ dB}$	Type N	\$4855	\$490
	8694B Opt. 200	PIN	>15 mW	$\pm 40\text{ MHz}$	$\pm 1\text{ MHz}$	<20 kHz	$\pm 0.75\text{ dB}$	Type N	\$6355	\$490
7.0–12.4 GHz	8694A Opt. 100	GRID	>25 mW	$\pm 1\%$	<160 MHz	<60 kHz	$\pm 0.75\text{ dB}$	Type N	\$5160	\$490
	8694B Opt. 100	PIN	>15 mW	$\pm 50\text{ MHz}$	$\pm 1\text{ MHz}$	<20 kHz	$\pm 0.75\text{ dB}$	Type N	\$6800	\$490
8.0–12.4 GHz	8694A	GRID	>50 mW	$\pm 1\%$	<160 MHz	<60 kHz	$\pm 0.75\text{ dB}$	Type N	\$4800	\$490
	8694B	PIN	>30 mW	$\pm 40\text{ MHz}$	$\pm 1\text{ MHz}$	<15 kHz	$\pm 0.75\text{ dB}$	Type N	\$6300	\$490
8.0–18.0 GHz	8694A Opt. 300	GRID	>10 mW	$\pm 1\%$	$\pm 150\text{ MHz}$	<150 kHz	—	Type N	\$9000	—
	8694B Opt. 300	PIN	>5 mW \pm	$\pm 1\%$	$\pm 1\text{ MHz}$	<50 kHz	—	Type N	\$10,500	—
10–15.5 GHz	8695A Opt. 100	GRID	>25 mW	$\pm 1\%$	<0.25 GHz	<150 kHz	—	Flat Flange for WR-75WG	\$8500	—
12.4–18.0 GHz	8695A	GRID	>40 mW	$\pm 1\%$	<0.25 GHz	<150 kHz	—	UG-419/U	\$5100	—
	8695B	PIN	>15 mW	$\pm 56\text{ MHz}$	$\pm 1\text{ MHz}$	<25 kHz	—	UG-419/U	\$5600	—
18.0–26.5 GHz	8696A	GRID	>10 mW	$\pm 1\%$	<0.36 GHz	<200 kHz	—	UG-595/U	\$6000	—
26.5–40 GHz	8697A	GRID	>5 mW	$\pm 1\%$	<0.53 GHz	<350 kHz	—	UG-599/U	\$8300	—
33–50 GHz	8697A Opt. H50	GRID	>3 mW	$\pm 1\%$	<0.68 GHz	<450 kHz	—	UG-383/U	\$12,500	—

1. Power level change specification for B units typically 10 dB, A units 6 dB.

2. Residual FM measured with 10 kHz bandwidth, cw mode

Opt 004: rear output 8691-8694, 8698-8699

add \$80

Opt 004: rear output 8695-8697

add \$155

Opt J54: phase lock input

add \$350

SWEEP OSCILLATORS

Digital Marker & Generator/Sweeper

Models 8600A and 8601A

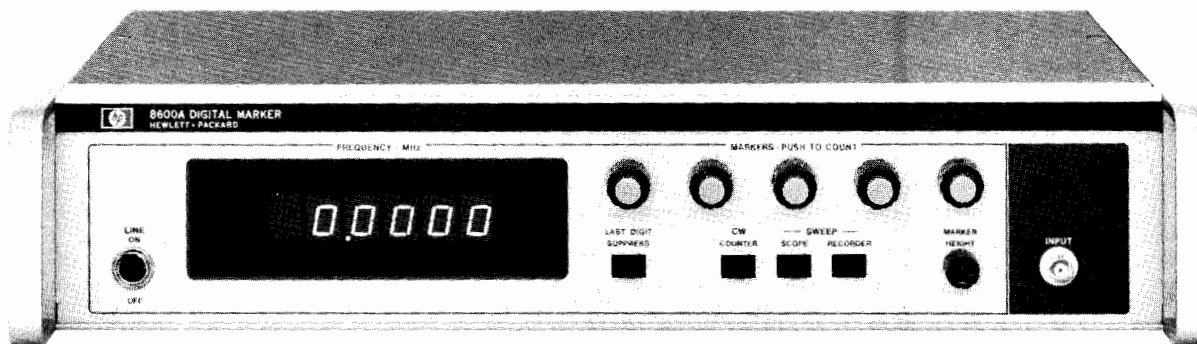

8600A



8601A

Covering 100 kHz to 110 MHz, the Model 8601A Generator/Sweeper combines the high linearity and flatness of a precision sweeper with a signal generator's frequency accuracy and wide range of calibrated power levels. Though it's small and lightweight, it does the work of two instruments easily and conveniently.

8601A Specifications

Frequency range: low range, 0.1-11 MHz; high range, 1-110 MHz.
Frequency accuracy: approximately $\pm 1\%$ of frequency.
Power output: +20 to -110 dBm; 10-dB steps and 13-dB vernier provide continuous settings over entire range. Meter monitors output in dBm and rms volts into 50 Ω .
Power accuracy: ± 1 dB accuracy for any output level from +13 dBm to -110 dBm.
Flatness: ± 0.25 dB over full range, ± 0.1 dB over any 10 MHz portion (+10 dBm step or below).

Impedance: 50 Ω , SWR <1.2 on 0 dBm step and below.
Harmonics and spurious signals: (CW above 250 kHz, output levels below +10 dBm) harmonics at least 35 dB below carrier. Spurious at least 40 dB below carrier.
Residual FM: noise in a 20 kHz bandwidth including line related components (dominant component of residual FM is noise).
CW: <50 Hz rms, low range; <500 Hz rms high range.
SYM 0, sweep: <100 Hz rms, low range; <1 kHz rms, high range.
Residual AM: AM noise modulation index (rms, 10 kHz bandwidth) is <-50 dB; (typically -60 dB at 25°C).
Crystal calibrator: internal 5 MHz crystal allows frequency calibration to $\pm 0.01\%$ at any multiple of 5 MHz.
Sweep modes: full, video, and symmetrical.
Internal AM: fixed 30% $\pm 5\%$ at 1 kHz.
External AM: 0 to 50%, dc to 400 Hz; 0 to 30%, up to 1 kHz.
Internal FM: 1 kHz rate, fixed 75 kHz $\pm 5\%$, deviation, high range; 7.5 kHz $\pm 5\%$, deviation, low range; <3% distortion.
External FM: sensitivity, 5 MHz per volt $\pm 5\%$, high range, 0.5 MHz per volt $\pm 5\%$, low range; negative polarity; FM rates to 10 kHz.
Weight: net, 9.5 kg (21 lb). Shipping, 12.3 kg (27 lb).
Size: 155 mm H x 190 mm W x 416 mm D (6 $\frac{3}{32}$ " x 7 $\frac{25}{32}$ " x 16 $\frac{3}{8}$ ").

The Model 8600A Digital Marker provides five independent, continuously variable frequency markers over the range 0.1-110 MHz when used with the HP 8601A or 8690B/8698B Generator Sweeper.

The high resolution controls and 6-digit readout permit 0.05% frequency settability. The frequency of any marker may be read while sweeping, simply by pushing a button within the marker control. The marker selected is brighter than the others and points in the opposite direction, ensuring positive marker identification.

8600A Specifications

Marker accuracy: any marker may be placed at a desired frequency $\pm (0.05\%$ of sweep width + sweeper stability).
Weight: net, 5.9 kg (13 lb); shipping 8.2 kg (18 lb).
Size: 99 mm H x 413 mm W x 337 mm L (3 $\frac{3}{8}$ " x 16 $\frac{3}{4}$ " x 13 $\frac{1}{4}$ ").

Ordering Information

8600A Digital Marker
Opt 001: Modification kit for 8690B/8698B
 8601A Generator/Sweeper
Opt 008: 75 Ω BNC output

Price
 \$2250
 N/C
 \$3950
 add \$50

Average Power Measurements

At microwave frequencies, power is the best measure of signal amplitude because, unlike voltage and current, power remains constant along a lossless transmission line. For this reason, power meters are almost indispensable for microwave measurement. Typical applications include monitoring transmitter power levels, calibrating signal generators, leveling signal sources, and measuring transmission characteristics of unknown devices.

To satisfy the requirements of this broad range of applications Hewlett-Packard has developed a family of general purpose microwave power meters. These power meters use a diode, thermocouple, or thermistor as the power sensing element, and it is important to understand the merits of each of these sensors before choosing a particular power meter.

Power Meters and Sensors

Hewlett-Packard makes five average-reading power meters. The 435B and the 436A are analog and digital meters, which are designed to operate with HP's line of thermocouple and diode power sensors. The 432 power meters are designed to operate with HP's line of thermistor mounts: the 432A is an analog power meter, the 432B is digital with BCD output, and the 432C is like the 432B but is fully programmable and auto-ranging.

Thermocouple power sensors are generally preferred for measuring power because they exhibit lower SWR and wider dynamic range than previously used thermistor elements. Low SWR is directly responsible for superior accuracy since mismatch errors are lower.

HP thermocouple sensors (8481, 8482, 8483, 8485A) are available from 100 kHz to 26.5 GHz and range from -30 dBm to +44 dBm. The model 8484A diode sensor operates with the same meters and extends the input level down to -70 dBm. This sensor uses a Low-Barrier Schottky Diode to achieve exceptional 100 pW (-70 dBm) sensitivity and low noise and drift. Because the diode is always operated in its square law region (voltage out \propto power in), the 8484A can be used to measure the true power of complex as well as CW waveforms.

Thermistor power sensors (478A, 486A series) operate with the 432A, 432B and 432C power meters. Since these power meters are based on balanced bridge principles, they are used whenever a direct dc-substitution technique is required. In addition, waveguide thermistor mounts are available from 8.20 to 40 GHz.

Peak Power Measurement

A frequent requirement in microwave work is the measurement of peak power in a periodic pulse. This may be done by various indirect techniques using thermocouples or thermistors. Hewlett-Packard also produces a versatile instrument that conveniently measures peak power directly in the 50 MHz to 2 GHz frequency range. Model 8900B utilizes a video comparator technique to bring a known dc voltage, supplied by the instrument in a known impedance, to a level which is equal to the pulse being measured. This allows simple measurement of peak pulse power with a basic accuracy of 1.5 dB even when the waveform is not rectangular. A custom calibration chart increases accuracy to 0.6 dB for critical applications.

Noise Figure Measurements

In RF and microwave communications, radar, etc., the weakest signal that can be detected is usually determined by the amount of noise added by the receiving system. From a performance standpoint, providing an increase in the receiver signal-to-noise ratio by reducing the amount of added noise is more economical than increasing the power of the transmitter.

The figure of merit that expresses how added noise obscures weak signals in a receiver, amplifier, or device is noise figure. Noise figure is the ratio, expressed in dB, of the actual output noise power of the device compared to the noise power which would be available if the device were perfect and merely amplified

the thermal noise of the input termination rather than contributing any noise of its own.

The Hewlett-Packard system of automatic noise figure measurement depends upon the periodic insertion of a known excess noise power at the input of the device under test. Subsequent detection of noise power results in a pulse train of two power levels. The power ratio of these two levels contains the desired noise figure information. Hewlett-Packard noise figure meters automatically measure and present this ratio directly in dB of noise figure.

Noise figure is discussed in detail in Hewlett-Packard AN 57, **Noise Figure Primer** and AN 64-3, **Accurate and Automatic Noise Figure Measurements**. AN 57 derives noise figure formulas, describes general noise figure measurements, and discusses accuracy considerations. AN 64-3 describes a highly repeatable and accurate noise figure measurement system for the 10 MHz to 18 GHz frequency range.

Automatic Noise Figure Measurements

AN 64-3 describes an automatic system for measuring noise and gain of devices such as amplifiers, mixers and complete receiver systems (see Figure 1). The desktop computer, in addition to automating the measurements, processes the data, corrects for its own noise contribution, and accounts for many small effects that, in manual noise measurement systems, are bothersome to correct and are often accepted as measurement errors. The cali-

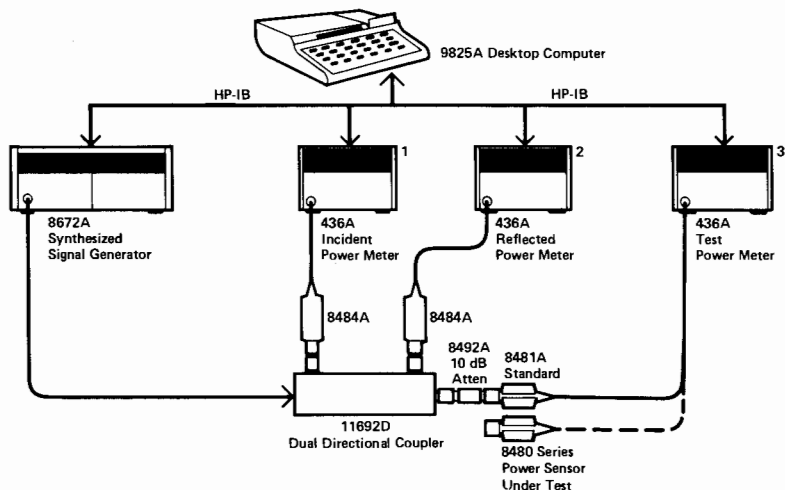

Figure 1. System for measuring calibration factor of power sensors.



bration data, stored on the system tape cartridge, allows significant accuracy improvements that would otherwise require tedious calculations. Maximum flexibility is insured through the use of standard instruments which can be put to a variety of alternate uses.

Measurement System

The noise figure measurement system (Figure 2) uses the 346B noise source, the 436A Power Meter, an 8484A Power Sensor, and other auxiliary equipment to reduce instrumentation uncertainty by a factor of one-third over most noise figure meters. The 436A measures the Y factor from which the computer calculates the corresponding noise figure. The 436A makes this measurement to an accuracy of ± 0.04 dB.

Computer Convenience

The computer is optional equipment which simplifies the measurement procedure and gives the system more capability than most noise figure meters. It commands the noise source ON and OFF, reads the power meter, and computes the noise figure.

In addition, the computer corrects for ambient temperature effects, corrects for variations of noise source output with frequency, tunes the frequency of the receiver and corrects for the noise contributed by the receiver to indicate the noise figure of the DUT alone.

Flexibility

Flexibility is another advantage of this system. The user can choose the IF frequency anywhere in the 10 MHz to 18 GHz band. Merely changing the IF bandwidth changes the bandwidth of the noise figure measurement. This means a narrow band filter just ahead of the 8484A Power Sensor can measure spot noise figure at a desired portion of the IF pass band.

Application Notes

Information on virtually all aspects of microwave power measurement is contained in Hewlett-Packard application notes. The AN 64 series is intended as the definitive publication for general theory, product oriented how-to descriptions, and a complete treatment of new, innovative automatic systems.

AN64-1, Fundamentals of RF and Microwave Power Measurements, deals with the general theory of microwave power measurements. It covers the basic principles of measurement, calculation of measurement uncertainty, traceability, etc.

AN64-2, Extended Applications of Automatic Power Meters, discusses an automatic power meter system for measuring attenuation, gain saturation, and the calibration factor of power sensors.

AN 64-3, Accurate and Automatic Noise Figure Measurements, describes a highly repeatable and accurate noise figure measurement system for the 10 MHz to 18 GHz frequency range. Automatic data processing

and error correcting features make the system easy to use. This system consists of mostly standard HP instruments that can be put to a variety of uses.

Application Note 64-3
Accurate and Automatic Noise Figure Measurements

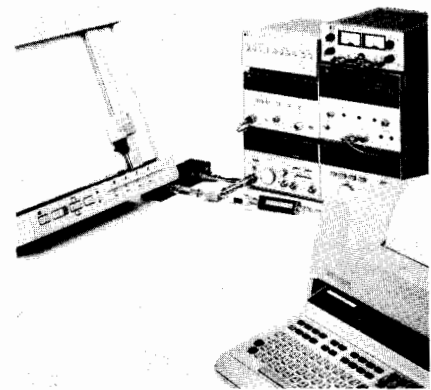

AN196, Automated Measurements Using the 436A Power Meter, contains several typical uses of the 436A with the HP-IB Interface bus.

All of these application notes and the **Coxial & Waveguide Catalog** are available without charge. See page 734.

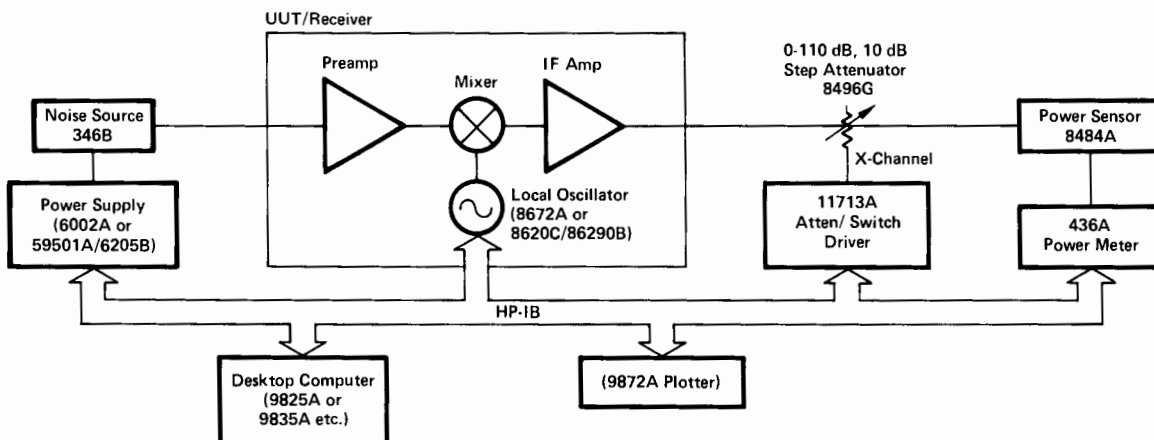
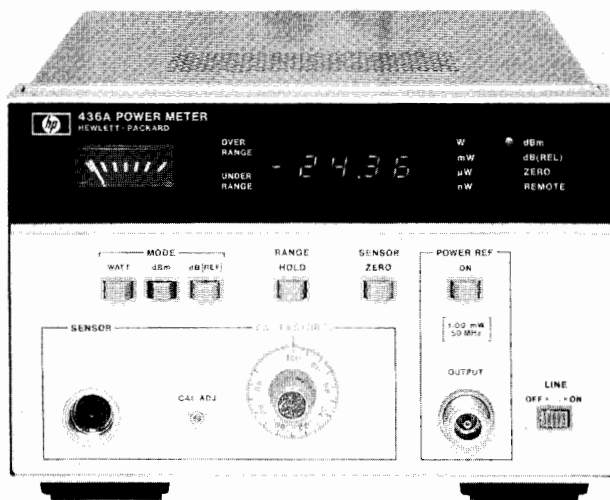

Figure 2. Noise figure measurement system.

POWER & NOISE FIGURE METERS

Thermocouple Power Meter

Model 436A



436A



436A Power Meter

The HP Model 436A Power Meter is a general purpose digital power meter intended for manual and automatic RF and microwave power measurements. It is compatible with the entire series of 8480 power sensors. Depending on which power sensor is used, the 436A can measure power from -70 dBm (100 pW) to $+44$ dBm (25W) at frequencies up to 26.5 GHz.

The logically organized and uncluttered front panel, and the convenience of push-button operation and digital display make the 436A both easy to interpret and easy to use in any application. The auto ranging capability allows for "hands-off" operation.

The 436A measures either absolute or relative power. It displays absolute power in either watts or dBm, and relative power in dB.

The 436A Power Meter also features optional programmability; both Hewlett-Packard Interface Bus (HP-IB) and BCD interfaces are available. These interfaces allow full remote control of all power meter functions (CAL function can be programmed to either 100 percent or the CAL factor which has been manually set on the front panel). These options may be added by the user at a later time.

436A Specifications

Frequency range: 100 kHz to 26.5 GHz (depending on power sensor used).

Power range (display calibrated in watts, dBm, and dB relative to reference power level).

With 8481A, 8482A, 8483A, 8485A sensors: 50 dB with 5 full-scale ranges of -20 , -10 , 0 , 10 , and 20 dBm ($10 \mu\text{W}$ to 100 mW).

With 8481B or 8482B sensors: 44 dB with 5 full-scale ranges of 10 , 20 , 30 , 40 , and 44 dBm (10 mW to 25 W).

With 8481H or 8482H sensors: 45 dB with 5 full-scale range of 0 , 10 , 20 , 30 and 35 dBm (1 mW to 3 W).

With 8484A sensor: 50 dB with 5 full-scale ranges of -60 , -50 , -40 , -30 , and -20 dBm (1 nW to $10 \mu\text{W}$).

Accuracy

Instrumentation

Watt mode: $\pm 0.5\%$.

dBm mode: $\pm 0.02 \text{ dB} \pm 0.001 \text{ dB}/^\circ\text{C}$.

dB (REL) mode¹: $\pm 0.02 \text{ dB} \pm 0.001 \text{ dB}/^\circ\text{C}$.

¹ Specifications are for within range measurements. For range-to-range accuracy add another $\pm 0.02 \text{ dB}$.

Zero: automatic, operated by a front-panel switch.

Zero set: $\pm 0.5\%$ of full scale on most sensitive range, typical; ± 1 count on other ranges.

Zero carry over: $\pm 0.2\%$ of full scale when zeroed on the most sensitive range.

Power reference: internal 50 MHz oscillator with Type N female connector on front panel (or rear panel, Option 003 only).

Power output: 1.0 mW. Factory set to $\pm 0.7\%$ traceable to the National Bureau of Standards.

Accuracy: $\pm 1.2\%$ worst case ($\pm 0.9\%$ rss) for one year (0°C to 55°C).

Supplemental Characteristics

Noise (typical, at constant temperature, peak change over any one-minute interval): 20 pW (8484A); 40 nW (8481A, 8482A, 8483A, 8485A); $40 \mu\text{W}$ (8481B, 8482B); $4 \mu\text{W}$ (8481H, 8482H).

Drift (1 hour, typical, at constant temperature after 24-hour warm-up): 20 pW (8484A); 10 nW (8481A, 8482A, 8483A, 8485A); $10 \mu\text{W}$ (8481B, 8482B); $1 \mu\text{W}$ (8481H, 8482H).

Response time typical, measured at recorder output, 0 to 99% of reading:

Range 1 (most sensitive range) < 10 seconds

Range 2 < 1 second

Ranges 3 through 5 < 100 milliseconds

Cal factor: 16-position switch normalizes meter reading to account for calibration factor. Range 85% to 100% in 1% steps.

Cal adj: front-panel adjustment provides capability to adjust gain in meter to match power sensor in use.

Recorder output: linearity proportional to indicated power with 1 volt corresponding to full scale and 0.316 volts to -5 dB ; $1 \text{ k}\Omega$ output impedance, BNC connector.

RF blanking: open collector TTL; pulls low during meter zeroing. Useful for turning off RF input to sensor during auto-zeroing. BNC connector.

Display: four-digit display with 20% over-range capability on all ranges; analog uncalibrated peaking meter to show fast changes.

Power consumption: 100, 120, 220, or 240 V ($+5\%$, -10%), 48 to 66 Hz, and 360 to 440 Hz; $< 20 \text{ V} \cdot \text{A}$ ($< 23 \text{ V} \cdot \text{A}$ with option 022 or 024).

Weight: net, 4.5 kg (10 lb); shipping, 5.5 kg (12 lb).

Size: 134 H x 213 W x 279 mm D (5.2 x 8.4 x 11.0 in.).

Accessories

Furnished: 1.5 m (5 ft) cable for power sensor; 2.3 m (7.5 ft) power cable. Mains plug shipped to match destination requirements.

Available: To rack mount one 436A by itself, order 5061-0057 Rack Mount Adapter Kit.

Coaxial & Waveguide Catalog & Microwave Measurement Handbook

96 pages with over 350 measurement accessories. Request card at back of this catalog.

Ordering Information

	Price
436A Power Meter	\$2250
Option 002: Input connector on rear panel in parallel with front	add \$25
Option 003: Input connector and reference oscillator output on rear panel only	add \$10
Option 009: 3 m (10 ft) cable for power sensor	add \$30
Option 010: 6.1 m (20 ft) cable for power sensor	add \$55
Option 011: 15.2 m (50 ft) cable for power sensor	add \$105
Option 012: 30.5 m (100 ft) cable for power sensor	add \$155
Option 013: 61 m (200 ft) cable for power sensor	add \$260
Option 022: Digital input/output, fully compatible with HP Interface Bus (HP-IB)	add \$425
Option 024: Digital input/output BCD Interfact	add \$325
Option 908: Kit for rack mounting one 436A	\$35
Option 910: Extra operating and service manual	add \$25

POWER & NOISE FIGURE METERS

Thermocouple Power Meter, Range Calibrator

Model 435B, 11683A

449



435B



11683A

435B Power Meter

The 435B Power Meter is an analog power meter, compatible with the entire series of 8480 power sensors. Depending on which sensor is used, the 435B can measure power from -65 dBm to $+44$ dBm, full scale, at frequencies from 100 kHz to 26.5 GHz. This versatile instrument also features $<1\%$ instrumentation uncertainty, low noise and drift, auto-zero, recorder output, optional battery operation, and long cable options up to 61 m (200 ft).

11683A Range Calibrator

The 11683A calibrator is specifically designed for use with the 435B and 436A power meters. It allows verification of full-scale meter readings on all ranges, as well as meter tracking. Simply connect the cable between the power meter and calibrator. The CAL ADJ control on the power meter is used to set the meter to full scale on the 1 mW range. The calibrator and meter are then stepped through the other ranges verifying accuracy within $\pm 1\%$ plus noise and drift. The 11683A also has a polarity switch which tests the Auto-Zero circuit.

435B Specifications

Frequency range: 100 kHz to 26.5 GHz (depending on power sensor used).

Power range (calibrated in watts and dB in 5 dB steps).

With 8481A, 8482A, 8483A or 8485A: -25 dBm ($3 \mu\text{W}$) to $+20$ dBm (100 mW) full scale.

With 8481B or 8482B: $+5$ dBm (3 mW) to $+44$ dBm (25 W) full scale.

With 8481H or 8482H: -5 dBm (0.3 mW) to $+35$ dBm (3 W) full scale.

With 8484A: -65 dBm (300 pW) to -20 dBm (10 μW) full scale.

Accuracy

Instrumentation: $\pm 1\%$ of full scale on all ranges.

Zero: automatic, operated by front-panel switch.

Zero set: $\pm 0.5\%$ of full scale on most sensitive range, typical.

Zero carryover: $\pm 0.5\%$ of full scale when zeroed on the most sensitive range.

Power reference: internal 50 MHz oscillator with Type N female connector on front panel (or rear panel, Option 003 only).

Power output: 1.00 mW. Factory set to $\pm 0.7\%$ traceable to the National Bureau of Standards.

Accuracy: $\pm 1.2\%$ worst case ($\pm 0.9\%$ rss) for one year (0°C to 55°C).

Supplemental Characteristics

Noise (typical, at constant temperature, peak change over any one-minute interval): 20 pW (8484A); 40 nW (8481A, 8482A, 8483A, 8485A); 40 μW (8481B, 8482B); 4 μW (8481H, 8482H).

Drift (1 hour, typical, at constant temperature after 24-hour warm-up): 40 pW (8484A); 15 nW (8481A, 8482A, 8483A, 8485A); 15 μW (8481B, 8482B); 1.5 μW (8481H, 8482H).

Response Time (typical, measured at recorder output, 0 to 99% of reading):

Range 1 (most sensitive range)	< 10.0 seconds
Range 2	< 3.8 seconds
Range 3	< 1.3 seconds
Ranges 4 to 10	< 500 milliseconds

Cal factor: 16-position switch normalizes meter reading to account for calibration factor; range 85% to 100% in 1% steps.

Recorder output: linearly proportional to indicated power with 1 volt corresponding to full scale; 1 k Ω output impedance, BNC connector.

RF blanking output: provides a contact closure to ground. Used for turning off RF input to sensor during auto-zeroing. BNC connector.

Cal adj: front-panel adjustment provides capability to adjust gain of meter to match power sensor in use.

Power consumption: 110 or 120 V ($+5\%$, -10%), 48 to 66 Hz and 360 to 440 Hz; also 220 or 240 V ($+5\%$, -10%), 48 to 66 Hz only: $< 20\text{V} \cdot \text{A}$.

Weight: net, 2.7 kg (5.9 lb); shipping, 4.2 kg (9.2 lb).

Size: 155 H x 130 W x 279 mm D (6.3 x 5.1 x 11 in.).

Accessories

Furnished: 1.52 m (5 ft) cable for the power sensor; 2.3 m (7.5 ft) power cable, (mains plug shipped to match destination requirements).

Available (see page 721)

11076A: Carrying case.

5060-8762: Rack adapter frame (holds three instruments the size of the 435B).

Combining cases (see page 720)

1051A: 286 mm (11.25") deep.

1052A: 416 mm (16.4") deep.

These combining cases accept $\frac{1}{2}$ -module Hewlett-Packard instruments for bench use or rack mounting.

11683A Range calibrator

Calibration functions: outputs corresponding to meter readings of 3, 10, 30, 100 and 300 μW ; 1, 3, 10, 30, and 100 mW.

Calibration uncertainty: $\pm 0.25\%$ in all ranges.

Power: 115 or 230 V $\pm 10\%$, 50-400 Hz, less than 2 W.

Weight: net, 1.13 kg (2.5 lb); shipping, 1.9 kg (4.2 lb).

Size: 89 H x 133 W x 216 mm D (3.5 x 5.25 x 8.5 in.).

Ordering Information

11683A Range Calibrator

Price

\$625

435B Power Meter

\$1100

435B Options

001: Rechargeable battery installed provides up to 16 hours of continuous operation add \$100

002: Input connector placed on rear panel in parallel with front add \$25

003: Input connector and reference oscillator output on rear panel only add \$10

009: 3.0 m (10-foot) cable for power sensor add \$30

010: 6.1 m (20-foot) cable for power sensor add \$55

011: 15.2 m (50-foot) cable for power sensor add \$105

012: 30.5 m (100-foot) cable for power sensor add \$155

013: 61 m (200-foot) cable for power sensor add \$260

910: Extra operating and service manual add \$7.50

POWER & NOISE FIGURE METERS

Power Sensors

Models 8481A/B, 8481H, 8482A/B, 8482H, 8483A, 8484A, 8485A, 11708A

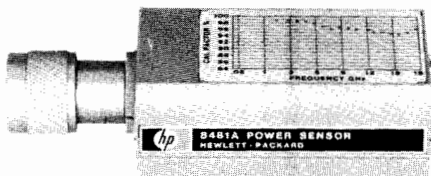

8481A

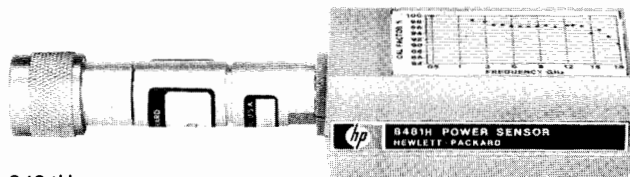

8481H

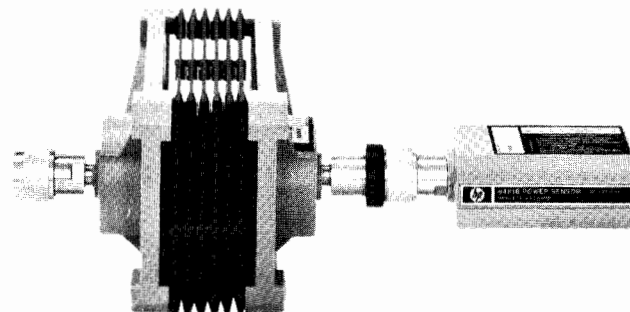

8481B

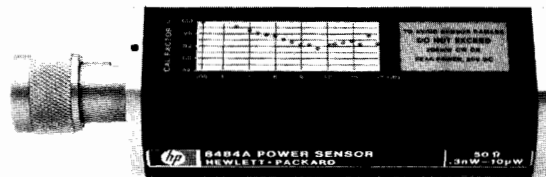

8484A



11708A

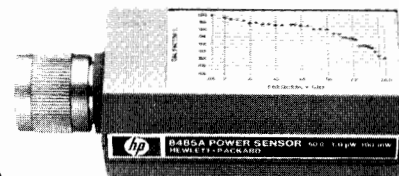

8485A

High Power Sensors to 25 Watts

The new 8481B and 8482B high power sensors both have a power range of 1 mW to 25 watts. The 8481B covers a frequency range of 10 MHz to 18 GHz and the 8482B has a frequency range of 100 kHz to 4.2 GHz.

Previous methods of measuring medium power levels usually required adding a separate attenuator in front of a low power sensor. With the 8481/82B power sensors, the attenuator and sensor are combined into one unit. This reduces mismatch uncertainty error and improves accuracy by including the attenuator in the measured Calibration Factor curves. In addition, the design incorporates lightweight, heat-dissipating fins to prevent burns.

Medium Power Sensors to 3 Watts

Model 8481H measures power from 100 μ W to 3 watts over a frequency range of 10 MHz to 18 GHz. The 8482H measures power from 30 μ W to 3 watts over a frequency range of 100 kHz to 4.2 GHz.

Standard Sensors to 100 mW

The 8481A, 8482A, 8483A, and 8485A power sensors all measure power over a range of 0.3 μ W to 100 mW. The 8481A is a 50-ohm sensor with a frequency range of 10 MHz to 18 GHz. The 8482A is a 50-ohm sensor with a frequency range of 100 kHz to 4.2 GHz. The 8485A is a 50-ohm sensor with a frequency range of 50 MHz to 26.5 GHz. The 8483A is a 75-ohm sensor and covers a frequency range of 100 kHz to 2 GHz.

High Sensitivity Sensors

The 8484A measures power from 0.1 nW to 10 μ W over a frequency range of 10 MHz to 18 GHz. It is furnished with the 11708A 50 MHz Reference Attenuator for precise calibration with 1 mW Power Meter Reference Oscillator. Noise and drift have been reduced to less than 5% of full scale on the 300 pW range—only 15 pW when it is used with the 435B Power Meter. Noise and drift are even less with the 436A Power Meter.

Broadband Power Sensor

The 8485A thermocouple power sensor covers a frequency range of 50 MHz to 26.5 GHz and a power range of -30 dBm to +20 dBm (1 μ W to 100 μ W). Low SWR (<1.25 at 26.5 GHz) reduces mismatch uncertainty which increases power measurement accuracy. The ruggedized APC-3.5 input connector is SMA compatible and repeatable. The actual Cal Factor is plotted on each 8485A label at 34 frequencies. Each unit is shipped with a print-out which lists Cal Factor plus the actual SWR (reflection coefficient) in magnitude and phase.

8480 Series Power Sensors

The 8480 series of power sensors have been designed for use with the 435B and 436A Power Meters. They feature wide frequency and amplitude ranges in addition to very low SWR.

The power measurement range of these sensors is from 0.1 nW to 25 Watts. With just three sensors a power measurement range of 114 dB can be achieved.

Wide Frequency Range for Many Applications

Power measurements can be made over a frequency range of 100 kHz to 26.5 GHz. The four frequency ranges covered with these units are 10 MHz to 18 GHz, 100 kHz to 4.2 GHz, 50 MHz to 26.5 GHz, and 100 kHz to 2 GHz, with the 75-ohm unit.

Low SWR for Low Measurement Uncertainty

The 8481/82/83/85 series of sensors use a silicon monolithic thermocouple as the sensing element. The small physical size of the thermocouple enables the sensors to have a very low SWR even at 26.5 GHz. A low SWR reduces mismatch uncertainty error, one of the largest single sources of error in power measurements. The 8484A sensor uses a crystal detector for higher sensitivity without degrading SWR.

Individually Calibrated for More Confidence in Results

Each sensor is individually calibrated, traceable to the National Bureau of Standards. A Cal Factor control on the meter compensates for power sensor efficiency at any frequency. A precise Automatic Network Analyzer printout for Cal Factor and reflection coefficient in magnitude and phase is supplied with the 8481A/B/H, 8484A, and 8485A. This means you can significantly reduce mismatch uncertainty by calculating the mismatch error.



8480 Series Specifications

Model	Nominal Impedance	Frequency Range	Power Range	Maximum Power	Power Linearity ²	Maximum SWR (Reflection Coefficient)	Size mm (in.)	Shipping Weight kg (lb)	RF Connector	Price
8481A	50Ω	10 MHz-18 GHz	1 μW to 100 mW	300 mW avg. 15 W peak 30 W • μs (per pulse)	+10 to +20 dBm +2, -4%	10 MHz - 30 MHz: 1.40 (0.166) 30 MHz - 50 MHz: 1.18 (0.083) 50 MHz - 2 GHz: 1.10 (0.048) 2 - 12.4 GHz: 1.18 (0.083) 12.4 - 18 GHz: 1.28 (0.123)	30 x 38 x 105 (1.2 x 1.5 x 4.1)	0.5 (1)	N (m)	\$500
Option 001									APC-7	add \$25
8481B	50Ω	10 MHz-18 GHz	0-35°C, 1 mW-25W; 35°C-55°C, 1 mW-20 W	0-35°C: 30 W avg. ¹ 35°C-55°C: 25 W avg. 10 MHz-5.8 GHz 500 W peak 5.8-18 GHz 125 W peak 500 W • μs (per pulse)	+35 to +44 dBm ±4%	10 MHz - 2 GHz: 1.10 (0.048) 2-12.4 GHz: 1.18 (0.083) 12.4-18 GHz: 1.28 (0.123)	83 x 114 x 248 (3.25 x 4.5 x 9.75)	1.5 (3.2)	N (m)	\$990
8481H	50Ω	10 MHz-18 GHz	100 μW to 3W	3.5 W avg. 100 W peak 100 W • μs (per pulse)	+25 to +35 dBm ±5%	10 MHz - 8 GHz: 1.20 (0.091) 8-12.4 GHz: 1.25 (0.110) 12.4 - 18 GHz: 1.30 (0.130)	30 x 38 x 149 (1.2 x 1.5 x 5.9)	0.5 (1)	N(m)	\$625
8482A	50Ω	100 kHz-4.2 GHz	1.0 μW to 100 mW	300 mW avg. 15 W peak 30 W • μs (per pulse)	+10 to +20 dBm +2, -4%	100-300 kHz: 1.60 (0.231) 300 kHz - 1 MHz: 1.20 (0.091) 1 MHz - 2 GHz: 1.10 (0.048) 2-4.2 GHz: 1.30 (0.130)	30 x 38 x 105 (1.2 x 1.5 x 4.1)	0.5 (1)	N(m)	\$455
8482B	50Ω	100 kHz-4.2 GHz	0-35°C, 1 mW-25W; 35°C-55°C, 1 mW-20 W	0-35°C: 30 W avg. ¹ 35°C-55°C: 25 W avg. 500 W peak 500 W • μs (per pulse)	+35 to +44 dBm ±4%	100 kHz - 2 GHz: 1.10 (0.048) 2 GHz - 4.2 GHz: 1.18 (0.083)	83 x 114 x 248 (3.2 x 4.5 x 9.7)	1.5 (3.2)	N (m)	\$965
8482H	50Ω	100 kHz-4.2 GHz	100 μW to 3W	3.5 W avg. 100 W peak 100 W • μs (per pulse)	+25 to +35 dBm ±5%	100 kHz-4.2 GHz: 1.20 (0.091)	30 x 38 x 149 (1.2 x 1.5 x 5.9)	0.5 (1)	N(m)	\$590
8483A	75Ω	100 kHz-2 GHz	1.0 μW to 100 mW	300 mW avg. 10 W peak 30 W • μs (per pulse)	+10 to +20 dBm +2, -4%	100-600 kHz: 1.80 (0.286) 600 kHz - 2 GHz: 1.18 (0.083)	30 x 38 x 105 (1.2 x 1.5 x 4.1)	0.5 (1)	N(m) 75Ω	\$455
8484A ³	50Ω	10 MHz-18 GHz	0.1 nW to 10 μW	200 mW avg. 200 mW peak	-30 to -20 dBm ±1%	10-30 MHz: 1.40 (0.166) 30 MHz - 4 GHz: 1.15 (0.070) 4-10 GHz: 1.20 (0.091) 10-15 GHz: 1.30 (0.130) 15-18 GHz: 1.35 (0.149)	36 x 44 x 133 (1.4 x 1.7 x 5.2)	0.5 (1)	N(m)	\$675
8485A	50Ω	50 MHz-26.5 GHz	1 μW to 100 mW	300 mW avg. 15 W peak 30 W • μs (per pulse)	+10 to +20 dBm +2, -4%	50 MHz-100 MHz: 1.15 100 MHz-2 GHz: 1.10 2-12.4 GHz: 1.15 12.4-18 GHz: 1.20 18-26.5 GHz: 1.25	30 x 38 x 95 (1.2 x 1.5 x 3.7)	0.5 (1)	APC3.5(m)	\$700

¹For pulses greater than 30 W the maximum average power (Pa) is limited by the energy per pulse (E) in W • μs according to Pa = 30-0.02E.

²Negligible deviation except for those power ranges noted.

³Includes 1250-0597 adapter from 75 Ω type N to 50 Ω type N for calibration.

⁴The 11708A 30 dB attenuator for calibrating against a 0 dBm, 50 MHz power reference is shipped with the 8484A.

Uncertainty of calibration factor data for 8482A and 8483A

Frequency (MHz)	Sum of Uncertainties (%) ¹				Probable Uncertainties (%) ²			
	8482A	8482B	8482H	8483A	8482A	8482B	8482H	8483A
0.1	±2.3	±5.7	±3.3	±2.6	±1.3	±2.8	±1.6	±1.5
0.3	2.2	5.7	3.2	2.5	1.2	2.8	1.6	1.4
1.0	2.2	5.7	3.2	2.5	1.2	2.8	1.6	1.4
3.0	2.2	5.7	3.2	2.5	1.2	2.8	1.6	1.4
10.0	2.5	5.7	3.5	3.0	1.3	2.8	1.6	1.6
30.0	2.6	5.7	3.6	3.1	1.4	2.8	1.7	1.6
50.0	O(ref)	2.7	O(ref)	O(ref)	O(ref)	2.7	O(ref)	O(ref)
100.0	3.1	5.6	4.1	3.9	1.6	3.3	1.9	2.0
300.0	3.1	5.6	4.1	3.9	1.6	3.3	1.9	2.0
1000.0	2.7	5.7	3.7	3.7	1.4	3.3	1.7	2.0
2000.0	2.7	5.5	3.7	3.9	1.4	3.1	1.7	2.1
4000.0	2.8	5.5	3.8	—	1.5	3.1	1.8	—

Uncertainty of calibration factor data for 8481A/B, 8484A and 8485A

Frequency (GHz)	Sum of Uncertainties (%) ¹					Probable Uncertainties (%) ²				
	8481A	8481B	8481H	8484A	8485A	8481A	8481B	8481H	8484A	8485A
0.1	±3.1	±6.4	±4.1	±4.4	—	±1.6	±3.0	±1.9	±1.9	—
2	2.7	5.8	3.7	4.0	±3.6	1.4	3.1	1.7	1.8	±2.1
4	2.8	5.8	3.8	4.1	—	1.5	3.1	1.8	1.8	—
6	2.8	5.8	3.8	4.1	4.0	1.5	3.1	1.8	1.8	2.3
8	3.2	6.0	4.2	4.6	—	1.7	3.2	2.0	2.0	—
10	3.6	6.2	4.6	5.1	4.7	1.9	3.3	2.2	2.2	2.7
12	3.9	7.8	4.9	6.5	—	2.1	4.1	2.4	2.8	—
14	4.8	7.9	5.8	7.4	5.6	2.6	4.1	2.8	3.2	3.2
16	5.2	8.0	6.2	7.8	—	2.9	4.2	3.0	3.4	—
18	5.8	8.3	6.8	8.4	5.9	3.2	4.3	3.4	3.7	3.6
22	—	—	—	—	6.8	—	—	—	—	3.7
26.5	—	—	—	—	7.3	—	—	—	—	4.0

¹Includes uncertainty of reference standard and transfer uncertainty. Directly traceable to NBS.

²Square root of sum of the individual uncertainties squared (RSS).



POWER & NOISE FIGURE METERS

Thermistor Power Meters

Models 432A/B/C

- Automatic zero
- High accuracy

- Recorder outputs, analog & digital
- Long cable options



432A



432B



432C

432A/B/C Power Meters

High accuracy—no thermoelectric error: High accuracy over a wide temperature range is featured on the 432 Power Meters. By measuring the output voltage of the thermistor bridges, and computing the corresponding power, even higher accuracy of $\pm 0.2\% \pm 0.5 \mu\text{W}$ can be obtained.

Accuracy can be maintained on even the most sensitive range because the error due to thermoelectric effect is reduced to a negligible level.

Calibrated mounts: Each thermistor mount is furnished with data stating the Calibration Factor* and Effective Efficiency* at various frequencies across the operating range. For easy and accurate power measurements, the front panel of the 432 contains a calibration factor control, calibrated in 1% steps from 88% to 100%, that compensates for losses in the mount and eliminates the need for calculation.

Instrument type: automatic, self-balancing power meter for use with temperature-compensated thermistor sensor.

*"Calibration Factor" and "Effective Efficiency" are figures of merit expressing the ratio of the substituted signal measured by the power meter to the microwave power incident on and absorbed by the sensor.

Specifications (Partial)

Power Range

432A: seven ranges with full-scale readings of 10, 30, 100, and 300 μW , 1, 3, and 10 mW; also calibrated in dBm from -20 dBm to $+10$ dBm full scale in 5 dB steps.

432B, 432C: four ranges with full-scale readings of 10 and 100 μW , and 1 and 10 mW.

Noise: Less than 0.25% of full scale (typical).

Response time: At recorder output, 35 ms time constant (typical).

Fine zero: Automatic, operated by front panel switch. Remote fine zero may be accomplished with 432C.

Zero carryover: Less than 0.50% of full scale when zeroed on most sensitive range.

Meter

432A: taut-band suspension, individually calibrated, mirror-backed scales. Milliwatt scale more than 108 mm (4.25 in.) long.

432B, 432C: three digits with one digit overrange. 20% overrange capability on all ranges.

Calibration factor control: 13-position switch normalizes meter reading to account for thermistor sensor calibration factor. Range 100% to 88% in 1% steps.

Thermistor sensor: Thermistor sensors are required for operation of the 432A/B/C. For microwave sensors HP 478B, 8478B and 486 series see page 453.

Recorder output: Proportional to indicated power with 1 volt corresponding to full-scale. 1 k Ω output impedance.

BCD output: 8, 4, 2, 1 code: "1" positive. TTL compatible logic. Operates with HP 5055A Digital Recorder. "Print" and "Inhibit" lines available. (432B and 432C only.)

Model 432C control lines: Instrument is referenced to +5 V, "Logic 0" is equivalent to 0 V.

Power Consumption

432A: 115 or 230 V ac $\pm 10\%$, 50 to 400 Hz, 2.5 watts.

432B: 115 or 230 V ac $\pm 10\%$, 50 to 400 Hz, 10 watts.

432C: 115 or 230 V ac $\pm 10\%$, 50 to 400 Hz, 16 watts.

Weight

432A: net, 2.3 kg (5.5 lb); shipping, 4.6 kg (10 lb).

432B: net, 3 kg (6.5 lb); shipping, 4.8 kg (10.5 lb).

432C: net, 3.2 kg (7.2 lb); shipping, 5 kg (11 lb).

Size: 130 W x 155 H x 279 mm D (5.2 x 6.1 x 11.0 in.)

Ordering Information

	Price
432A Power meter	\$950
432B Power meter	\$1625
432C Power meter	\$2500

432A/B/C Options

001: rechargeable battery installed, provides up to 24 hours continuous operation (432A only)	add \$105
002: input connector placed on rear panel in parallel with front	add \$25
003: input connector on rear panel only	add \$10
009: 3.1 m (10 ft) cable for 110-ohm or 200-ohm sensor	add \$30
010: 6.1 m (20 ft) cable for 100-ohm or 200-ohm sensor	add \$55
011: 15.2 m (50 ft) cable for 100-ohm or 200-ohm sensor	add \$105
012: 30.5 m (100 ft) cable for 100-ohm or 200-ohm sensor	add \$155
013: 61 m (200 ft) cable for 100-ohm or 200-ohm sensor	add \$260
100: 100 Vac operation	no charge
910: extra operating and service manual	add \$5

POWER & NOISE FIGURE METERS

Thermistor Mounts, Peak Power Calibrator & Power Meter Calibrator

Models 478A, 8478B, 486 Series, 8900B, 8477A



478A



8478B



486 Series



8900B

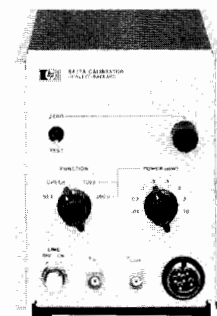

8477A

8900B Peak Power Calibrator

The HP 8900B peak power calibrator provides a convenient means for measuring the peak RF power of pulses in the range from 50 to 2000 MHz. The power level is read out directly on the panel meter and is completely independent of repetition rate and pulse width ($>0.25 \mu\text{sec}$).

8900B Specifications

Radio Frequency Measurement Characteristics

Frequency range: 50 to 2000 MHz.

RF power range: 10-200 mW peak full scale (may be readily increased through use of external attenuators or directional couplers).

RF power accuracy: $\pm 1.5 \text{ dB}$ ($\pm 0.6 \text{ dB}$ with custom calibration curve furnished with instrument).

RF power precision: 0.1 dB.

RF pulse width: $>0.25 \mu\text{s}$.

RF repetition rate: 1.5 MHz maximum.

RF impedance: 50 ohms.

RF VSWR: <1.25 .

Monitor Output

Level: >0.2 volt for 20 mW input (nominal).

Impedance: 150 ohms nominal.

Bandwidth: $>7 \text{ MHz}$.

General

Size: 156 H x 197 W x 279 mm D (6.1 x 7.75 x 11 in.).

Weight: net, 4.5 kg (10 lb); shipping, 5.9 kg (13 lb).

Power consumption: 105 to 125 or 210 to 250 volts, 50 to 60 Hz.

8477A Power Meter Calibrator

The 8477A Calibrator is specifically designed for use with the 432 Power Meter. It allows you to verify full-scale meter readings on all ranges, and meter tracking. Simply connect three cables between the power meter and calibrator; no charts or additional instruments are required.

8477A Specifications

Calibration points: outputs corresponding to meter readings of: 0.01, 0.03, 0.1, 0.3, 1.0, 2.0, 3.0, and 10 mW (for mount resistance switch settings of both 100 and 200 ohms).

Calibration uncertainty: $\pm 0.2\%$ on the top five ranges, and $\pm 0.5\%$ on the 0.01 and 0.03 mW ranges from $+20^\circ$ to $+30^\circ\text{C}$.

RFI: meets all conditions specified in MIL-I-6181D.

Power: 115 or 230 V $\pm 10\%$, 50-400 Hz, approximately 2 W.

Weight: net, 2.0 kg (4.5 lb); shipping, 2.9 kg (6.25 lb).

Size: 155 H x 130 W x 203 mm D (6.1 x 5.1 x 8 in.).

Ordering Information

8900B Peak power calibrator

8477A Power meter calibrator

Price

\$1200

\$625

Temperature Compensated Thermistor Mounts

High efficiency and good RF match are characteristic of the HP 478A and 8478B Coaxial and 486A Series Waveguide Thermistor mounts. Used in conjunction with the 432 Power Meter they provide high accuracy even in routine power measurements. These thermistor mounts are temperature-compensated for low drift, even in the presence of thermal shocks, permitting measurement of microwave power as low as one microwatt. Each mount contains data showing Calibration Factor and Effective Efficiency at six frequencies, directly traceable to the National Bureau of Standards at those frequencies where NBS provides calibration service.

486, 478, 8478B Specifications

Model	Frequency range, GHz	Maximum SWR	Operating Resistance (Ohms)	Price
478A	10 MHz to 10 GHz	1.75, 10 to 25 MHz 1.3, 25 MHz to 7 GHz 1.5, 7 to 10 GHz	200	\$260
8478B ¹	10 MHz to 18 GHz	1.75, 10 to 30 MHz 1.35, 30 to 100 MHz 1.1, 0.1 to 1 GHz 1.35, 1 to 12.4 GHz 1.6, 12.4 to 18 GHz	200	\$400
X486A	8.20 to 12.4	1.5	100	\$300
M486A	10.0 to 15.0	1.5	100	\$450
P486A	12.4 to 18.0	1.5	100	\$350
K486A ²	18.0 to 26.5	2.0	200	\$450
R486A ²	26.5 to 40.0	2.0	200	\$500

¹Option 011: furnished with APC-7 RF connector

add \$25

²Circular flange adapters:

K-band (UG-425/U) HP 11515A

\$135

R-band (UG-381/U) HP 11516A

\$135

POWER & NOISE FIGURE METERS

Automatic Noise Figure Meter, Broadband Noise Source

Models 8970A, 346B

- Accurate and simple, swept or CW measurements.
- Automatic operation, 10 MHz—18 GHz.
- Second stage correction.
- Display of both noise figure and gain.
- Calibrated display on oscilloscope or recorder.
- Powerful special function enhancements.

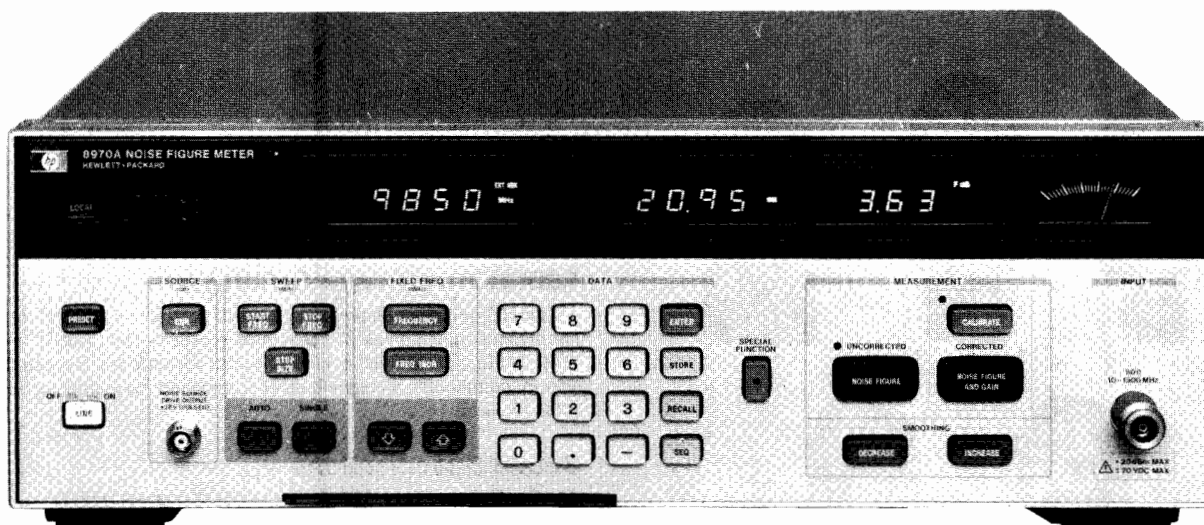

8970A

8970A Noise Figure Meter

With the 8970A Automatic Noise Figure Meter, accurate and repeatable noise figure measurements are now easy. RF and microwave (with an external local oscillator) measurements from 10 MHz to at least 18 GHz are equally simple; any IF between 10 and 1500 MHz may be used. The ENR (Excess Noise Ratio) calibration table of the noise source may be stored in the 8970A, and a properly interpolated value is automatically used at each frequency. Automatic second stage correction makes accurate noise figure readings possible even for low gain devices. The 8970A's dynamic range allows it to measure either gain up to at least 40 dB (higher in some cases) or loss to -20 dB, with no external attenuation or amplification required.

Microprocessor and Controller Functions

The 8970A takes the mystery out of noise figure measurement. It uses a microprocessor to make the myriad calculations and corrections necessary for truly accurate, convenient and flexible noise figure measurement. The 8970A also acts as a controller to external HP-IB local oscillators (such as the 8672A Synthesized Signal Generator or 8350A Sweep Oscillator) so that swept, broad-band microwave measurements of amplifiers, mixers, and transistors are essentially as simple as RF measurements.

In addition to acting as controller for an HP-IB local oscillator at microwave frequencies, the 8970A is fully programmable. Virtually all front panel buttons and functions are accessible over HP-IB, which is Hewlett-Packard's enhanced implementation of IEEE-488.

Simple Calibration and Second Stage Correction

Accuracy is greatly enhanced because the 8970A measures its own noise figure (and that of the rest of the measurement system) at up to 81 points. It stores this information, interpolates if necessary, and corrects for it to remove second stage (measurement system) effects. The 8970A also measures the gain of the device under test (DUT).

Display

The 8970A has an LED digital front panel display. For swept display of Noise Figure and gain on an oscilloscope, or x-y recorder, rear panel BNC Connectors are available. Either display mode is easily

and accurately scaled from the 8970A from the front panel. The swept oscilloscope display allows the design engineer to optimize his DUT in real time for both corrected noise figure and gain. The noise figure display is easily changed from noise figure to effective noise temperature (T_e) if desired, or y factor.

Front Panel and Special Functions

The 8970A front panel buttons control the number entry, calibration, and measurement functions. STORE, RECALL, and SEQ buttons allow up to 9 front panel settings to be stored and sequenced automatically or manually to save set-up time. Smoothing INCREASE and DECREASE buttons are used to average up to 512 readings before display, to eliminate flicker and increase accuracy.

The simple front panel control of the 8970A satisfies many noise figure measurement need. In addition, for those who may need even greater measurement power, there are more than 150 special functions that are easily selected via a numerical code and the SP button. Two examples are hot-cold measurements and automatic compensation for losses at the input of the DUT. One special function is a catalog that quickly indicates the current special function status. Three pull-out cards serve as a mini-reference manual to the instrument, including most of the special functions, the HP-IB formats and codes, and typical measurement setups. A complete set of service-oriented special functions can also be accessed.

346B Broadband Noise Source

The ideal companion to the 8970A is the 346B noise source, because of its broad 10 MHz to 18 GHz frequency range, low SWR, and accurate ENR calibration. The accurate calibration of ENR at 20 frequency points (nameplate plot and printout provided) and the low source SWR can reduce measurement uncertainty by several tenths of a dB, which is crucial in many measurements. The 346B output connector is available in APC 3.5 (compatible with SMA), Type N, and APC 7 styles. The drive voltage required for the 346B is 28 volts, and an internal regulator maintains performance despite power supply fluctuations.

POWER AND NOISE FIGURE METERS

Noise Figure Meters, Noise Sources
Models 340B, 342A, 343B, 347A, 11711A

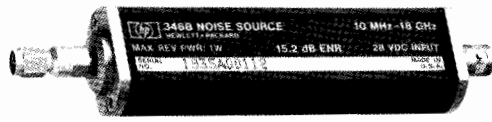

346B

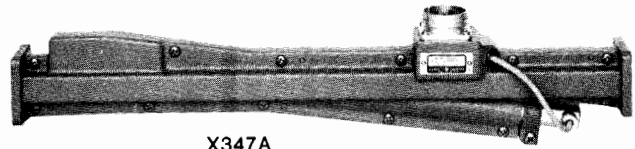

X347A

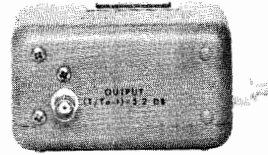

343A

Noise Figure Measurement Repeatability and Accuracy

A very troublesome noise figure measurement problem is repeatability. For example, a vendor's system may not measure the same noise figure as his customer's. This is much less of a problem with the 8970A. Using randomly selected 8970A's, 346B's, mixers, and local oscillators, superimposed plots of a single DUT are routinely within 0.1 dB of each other.

The 8970A internal circuitry is so accurate and linear that instrumentation uncertainty is less than ± 0.1 dB. With the ± 0.1 dB ENR uncertainty of the 346B at most frequencies, and the uncertainties due to mismatch, total root-sum-square measurement uncertainties of less than ± 0.25 are easily attainable.

8970A Partial Specifications

(See technical data sheet for complete specifications.)

Noise figure measurement range: 0 to 30 dB.

Noise figure instrumentation uncertainty: ± 0.1 dB

Noise figure resolution: 0.01 dB.

Gain measurement range: -20 to 40 dB.

Gain instrumentation uncertainty: ± 0.2 dB.

Gain resolution: .01 dB.

Frequency range: tunable from 10 to 1500 MHz.

Frequency resolution: 1 MHz.

Maximum operating input power: -10 dBm.

Maximum net external gain: 80 dB between noise source and 8970A RF input.

Noise source drive: 28.0 ± 0.1 volt

HP-IB capability: SH1, AH1, T5, L4, SR1, RL1, PP0, DC1, DT1, C1, 3, 28, E1.

Dimensions: 146 H x 425 W x 476 mm D (5.75 x 16.8 x 18.8 in.)

Weight: net, 14.5 kg (32 lb); shipping, 17.7 kg (39 lb).

346B Partial Specifications

(See technical data sheet for complete specifications.)

Frequency range: 10 MHz to 18 GHz.

Excess noise ratio (ENR) at 4 GHz and 17°C: 15.2 ± 0.3 dB.

Maximum SWR (reflection coefficient) on or off: 10 to 30 MHz—1.3 (0.13), 30 to 5000 MHz—1.15 (0.07), 5 to 18 GHz—1.25 (0.11).

Power required: 28 ± 1 volt.

Dimensions: 140 x 21 x 30 mm (5.5 x 0.8 x 1.2 in.)

Weight: net, 0.108 kg (3.5 oz); shipping, 0.5 kg (1 lb).

Ordering Information

8970A Noise Figure Meter

Option 907: Front panel handle kit

Option 908: Rack mounting flange kit

Option 909: Both options 907 and 908

Option 910: Extra operating manual and service manual

346B Noise Source

Option 001: Type N (male) connector

Option 002: APC-7 connector

Option 003: Type N (female) connector

Price

\$8500

add 32

add 25

add 55

add 25

1300

No charge

add 25

No charge

Noise Figure Meters and Noise Sources

Model 340B Noise Figure Meter, when used with the appropriate HP noise source, automatically measures and continuously displays noise figure for equipment with IF frequencies of 30 and 60 MHz. Model 342A is similar, and operates on frequencies of 30, 60, 70, 105 and 200 MHz.

HP noise sources provide calibrated noise for measurements on various equipment from IF amplifiers to complete radar systems. Model 343A VHF source operates from 10 to 600 MHz with 50 ohm impedance.

The 347A waveguide sources are argon gas discharge tubes carefully mounted in waveguide sections for frequencies from 3.95 to 18 GHz.

340B and 342A Partial Specifications

Noise figure range: with a 5.2 dB noise source, 0 to 15 dB, indication to infinity; with a 15.2 dB noise source, 3 to 30 dB, indication to infinity.

Accuracy (excluding source accuracy): noise diode scale: ± 0.5 dB, 0 to 15 dB; gas tube scale: ± 0.5 dB, 10 to 25 dB, ± 1 dB, 3 to 10 dB and 25 to 30 dB.

Input frequency: 340B: 30 or 60 MHz, selected by switch; 342A: 30, 60, 70, 105, and 200 MHz, selected by switch. Other frequencies available; prices and details on request.

Bandwidth: 1 MHz minimum.

Input: 50 ohms nominal; -60 to -10 dBm signal level.

Power input: 115 or 230 volts $\pm 10\%$, 50 to 60 Hz, 435 watts, max.

Size: cabinet, 324 H x 527 W x 368 mm D (12.8 x 20.3 x 14.5 in.).

Weights: net, 19.4 kg (43 lb); shipping, 23.9 kg (53 lb).

343A, 346B Partial Specifications

HP Model	Freq. Range (MHz)	Excess Noise Ratio dB	Max. SWR 50 Ω Nominal	RF Connector	Price
343A	10-600	5.2 ± 0.5	1.3 ON or OFF	BNC (f)	\$360
346B	10-18000	$\approx 15.2^*$	1.25 ON or OFF	APC-3.5	\$1300

*Individually calibrated at 20 frequencies.

347A Specifications

HP Model	Freq. Range (GHz)	Excess Noise Ratio dB	W/G WR	Equiv. Flange UG(-)/U	Price
G347A	3.95-5.85	15.2 ± 0.5	187	407	\$1200
J347A	5.30-8.20	15.2 ± 0.5	137	441	\$1200
H347A	7.05-10.0	15.6 ± 0.5	112	138	\$1250
X347A	8.20-12.4	15.7 ± 0.4	90	39	\$1050
P347A	12.4-18.0	15.8 ± 0.5	62	419	\$1100

Reflection coefficient for all models, fired or unfired, < 0.091 (SWR 1.2) max.

Ordering Information

340B Noise Figure Meter (cabinet)

340BR Noise Figure Meter (rack mount)

342A Noise Figure Meter (cabinet)

342AR Noise Figure Meter (rack mount)

11711A Noise Source Adapter (adapts 346B to 340B and 342A)

Price

\$2650

\$2625

\$2700

\$2675

\$150

MICROWAVE TEST EQUIPMENT

Microwave Measurements and Products



Microwave Test Equipment Product Line

Hewlett-Packard offers a complete line of microwave coaxial and waveguide measuring equipment. Measuring systems can be assembled from this equipment to make accurate reflection and transmission measurements on other components such as filters, mixers, cables, etc.

The bulk of microwave measurements made in production test, maintenance, and calibration require amplitude information only. These are sometimes referred to as scalar measurements.

The tables to the right summarize HP capabilities in scalar microwave measurements. More detailed information is available in the following publications:

AN 64-2 Extended Applications of Automatic Power Meters

AN 64-3 Accurate and Automatic Noise Figure Measurements

AN 183 High Frequency Swept Measurements

AN 196 Automated Measurements

Using the 436A Power Meter

Coaxial and Waveguide Catalog and Microwave Measurement Handbook

Complimentary copies are available from HP offices or you can use the request card at the back of this catalog.

HP Impedance/SWR Measuring Techniques and Capabilities

Measurement Technique	Coaxial Freq. Range	Waveguide Freq. Range	Typical Range	Remarks/Cost/Accuracy/Speed
Manual Slotted Line	500-4000 MHz 1-18 GHz	3.95-18 GHz (4 Bands)	30-35 dB	Lowest cost, high accuracy, slow, point-by-point
Swept Slotted Line	1.8-18 GHz	—	34 dB	Moderate cost, high accuracy, good speed, comprehensive
Reflectometer Square-Law	100-4000 MHz 2-18 GHz	3.95-40 GHz (6 Bands)	35-40 dB	Moderate cost, moderate accuracy, fast, comprehensive
Reflectometer RF-Substitution	100-4000 MHz 2-18 GHz	3.95-40 GHz (6 Bands)	50 dB	Moderate cost, high accuracy, fast, requires display storage
Bridge	1-110 MHz 40 MHz-18 GHz	—	40 dB	Multi-octave, good for coax, best for low SWR, 9 dB insertion loss

HP Insertion Loss Measuring Techniques and Capabilities

Measurement Technique	Coaxial Freq. Range	Waveguide Freq. Range	Typical Range	Remarks/Cost/Accuracy/Speed
Square-Law	10 MHz-18 GHz	2.6-40 GHz (7 Bands)	50 dB	Low cost, moderate accuracy, simple, fast
RF Substitution	10 MHz-18 GHz	2.6-18 GHz 18-40 GHz	50-100 dB 50-80 dB	Moderate cost, high accuracy, fast, requires display storage
IF Substitution	10 MHz-18 GHz	2.6-18 GHz (5 Bands)	30-120 dB	High cost, very high accuracy, best range, moderate speed
Desktop computer mini-system	100 kHz-4 GHz 10 MHz-18 GHz	—	40-70 dB	Moderate cost, very high accuracy, automated

MICROWAVE TEST EQUIPMENT

Variable Attenuators and OEM Step Attenuators

Models 375 series, 382 series, 393A, 394A, 33300 series, 33320 series

457

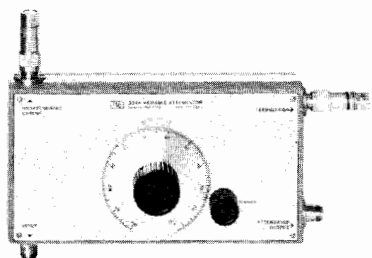

394A

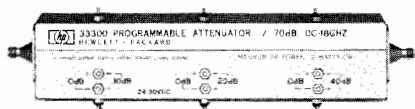

33300A

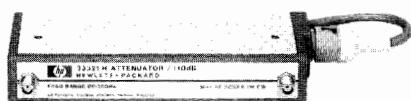

33321H

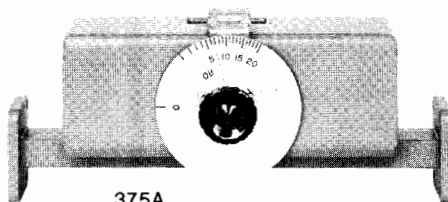

375A

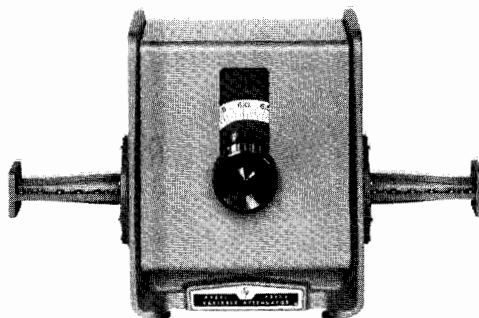

P382A

393A, 394A Coaxial Variable Attenuator 33300 Series, 33320 Series OEM Step Attenuators

Models 393A and 394A are high power, variable coaxial attenuators for the 0.5 to 2 GHz range. They use the principle of a variable directional coupler to achieve up to 120 dB range with 200 watt power handling capability.

33300 series step attenuators provide wideband programmable signal level control. Magnetic latching solenoids switch individual attenuating elements into and out of contact with a 50-ohm transmission line. C/D models have separate indicator contacts and A/B models have no indicator contacts. Three three-digit connector options (0XY) must be specified. X is the input connector, Y is the output connector, first digit is always 0. See specifications table for option numbers.

33320 series step attenuators are compact versions of the 8494/5/6

393A, 394A, 33300 Series, 33320 Series Specifications

Model	Freq Range (GHz)	Mode	Range	Remarks	Price
393A	0.5-1	Manual	5-120 dB Variable	200 W average	\$1650
394A	1-2	Manual	6-120 dB Variable	200 W average	\$1575
33300 A/B C/D	dc-18	Prog.	0-70 dB 10 dB steps	A&C models 12-15 V	\$1050 \$1090
33301 A/B C/D	dc-18	Prog.	0-42 dB 6 dB steps	B&D models 24-30 V	\$1050 \$1090
33304 A/B C/D	dc-18	Prog.	0-11 dB 1 dB steps	Connector options available:	\$1390 \$1425
33305 A/B C/D	dc-18	Prog.	0-110 dB 10 dB steps	0: N(f), 1: N(m) 2: 7mm(f), 3: 7mm(m) 5: SMA(f), 6: SMA(m)	\$1390 \$1425
33320A B	dc-4 dc-18	Manual	1-11 dB 1 dB steps	Specifications identical to 8494 series previous page	\$ 590 \$ 760
33320G H	dc-4 dc-18	Prog.			\$ 925 \$1165
33321A B D	dc-4 dc-18 dc-26.5	Manual	0-70 dB 10 dB steps	Specifications identical to 8495 series previous page	\$ 425 \$ 555 \$ 835
33321G H K	dc-4 dc-18 dc-26.5	Prog.			\$ 765 \$ 860 \$1260
33322A B	dc-4 dc-18	Manual			0-110 dB 10 db steps
33322G H	dc-4 dc-18	Prog.	\$ 925 \$1165		

bench attenuators on page 460 (same specifications) and are configured for designing into microwave systems and instruments. Manual or electrically-actuated versions are available. The manual models take less than 1.5 square inches of panel space. OEM quantity discounts are available for 33300 and 33320 series.

375 Series, 382 Series Waveguide Attenuators

Operation of these 382 series rotary-vane, continuously-variable attenuators depends on a mathematical law, rather than on the resistivity of the attenuator card. They are direct-reading and provide accurate attenuation from 0 to 50 dB (60 dB for S382C) regardless of temperature and humidity.

375A series variable flap attenuators consist of a short slotted section of waveguide in which a matched resistive strip is inserted.

Coaxial and Waveguide Catalog & Microwave Measurement Handbook

96 pages with over 350 measurement accessories. Request card at back of this catalog.

375A Series 382 Series Specifications

Model	Frequency Range (GHz)	Accuracy	Attenuation Range (dB)	Waveguide & Equivalent Flange	Price
S382C	2.6-3.95	±1% of reading or 0.1 dB whichever greater ±2% above 50 dB	0-60	WR 284 UG-584/U	\$3450
G382A	3.95-5.85	±2% of reading or 0.1 dB whichever greater	0-50	WR 187 UG-407/U	\$2325
J382A	5.3-8.2	±2% of reading or 0.1 dB whichever greater	0-50	WR 137 UG-441/U	\$1950
H382A	7.05-10.0	±2% of reading or 0.1 dB whichever greater	0-50	WR 112 UG-138/U	\$1875
X382A	8.2-12.4	±2% of reading or 0.1 dB whichever greater	0-50	WR 90 UG-135/U	\$1150
P382A	12.4-18.0	±2% of reading or 0.1 dB whichever greater	0-50	WR 62 UG-419/U	\$1150
K382A	18.0-26.5	±2% of reading or 0.1 dB whichever greater	0-50	WR 42 UG-597/U	\$1950
R382A	26.5-40.0	±2% of reading or 0.1 dB whichever greater	0-50	WR 28 UG-599/U	\$1875
X375A	8.2-12.4	±1 dB, ±2 dB	0-20	WR 90 UG-39/U	\$ 550
P375A	12.4-18	±1 dB, ±2 dB	0-20	WR 62 UG-419/U	\$ 550



MICROWAVE TEST EQUIPMENT

Coaxial Fixed Attenuators

Models 8491A/B, 8492A, 8493A/B, 8498A, 11581/2/3A

- Flat frequency response
- Low SWR
- Specifications traceable to NBS



11581A

8491A/B, 8492A, 8493A/B Fixed Attenuators

Hewlett-Packard coaxial fixed attenuators provide precision attenuation, flat frequency response, low SWR over broad frequency ranges at low prices. Attenuators are available in nominal attenuations of 3-dB and 6-dB, also 10-dB increments from 10 dB to 60 dB. These attenuators are swept-frequency tested to ensure meeting specifications at all frequencies. Calibration points are provided on a nameplate chart attached to each unit.

11581A, 11582A, 11583A Attenuator Sets

A set of four Hewlett-Packard attenuators—3, 6, 10 and 20 dB—are furnished in a handsome walnut accessory case. The 11581A set consists of 8491A attenuators. A set of 8491B attenuators is contained in the 11582A, and the 11583A consists of 8492A attenuators. In addition to the calibration label on each of the attenuators, the set includes a calibration report. The calibration report is certified traceable to the National Bureau of Standards, and includes both the attenuation and the reflection coefficients for each attenuator at four frequencies for the 11581A (dc, 4, 8, 12.4 GHz) and five frequencies for the 11582A and 11583A (dc, 4, 8, 12.4, 18 GHz). By specifying option 890, calibration data is given at 26 frequencies (11581A) or 42 frequencies (11582A and 11583A). See next page for exact frequency lists.

These sets are ideal for calibration labs or where precise knowledge of attenuation and SWR is desired.

8498A High Power Attenuator

The 8498A Option 030 is designed to meet the needs of high power attenuation applications in the RF and microwave frequency range. It is specified from dc to 18 GHz at 25 watts average, 500 watts peak, from dc to 5.8 GHz and 125 watts peak from 5.8 to 18 GHz. Available only in a 30 dB model (option 030), the unit offers low SWR (<1.30 at 18 GHz) and good accuracy (± 1 dB at 18 GHz). The unit also features 'human engineered' cooling fins that prevent operation burns even under continuous maximum input power conditions.

HEWLETT PACKARD OPTION 890 CALIBRATION REPORT				
MODEL: 8492A OPT 010	SERIAL NO: 9061			
DATE: 02-23-78	TECHNICIAN: 02307			
CALIBRATION SYSTEM: 8542B SYSTEM 8				
PORT IDENTIFICATION: WITH LABEL FACING THE USER, PORT 1 IS ON THE LEFT AND PORT 2 IS ON THE RIGHT.				
FREQUENCY (MHZ)	ATTENUATION (DB)	SWR PORT 1	SWR PORT 2	
100.00	10.01	1.025	1.005	
500.00	10.01	1.025	1.005	
1000.00	10.01	1.025	1.007	
1500.00	10.03	1.027	1.010	
2000.00	10.02	1.025	1.013	
2500.00	10.02	1.025	1.014	
3000.00	10.02	1.025	1.014	
4000.00	10.05	1.115	1.105	
5000.00	10.05	1.105	1.105	
10000.00	10.05	1.105	1.115	
15000.00	10.01	1.110	1.118	
17500.00	10.02	1.105	1.105	
17500.00	10.04	1.094	1.101	
18000.00	10.00	1.092	1.077	
18250.00	9.96	1.082	1.069	
18500.00	9.95	1.085	1.060	
18.500.00	9.98	1.104	1.054	
18000.00	9.94	1.074	1.054	
17.500.00	9.94	1.085	1.055	
17.500.00	9.93	1.094	1.065	
17.500.00	9.91	1.077	1.075	
17.000.00	9.95	1.074	1.058	

Option 890

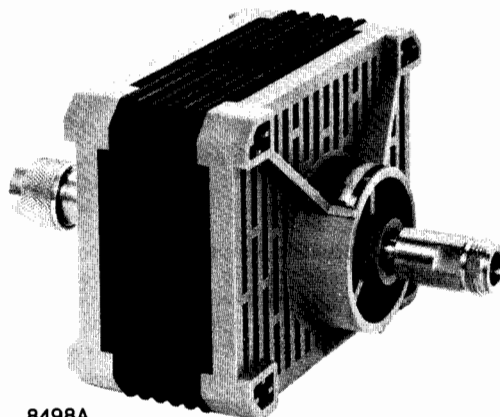

8498A
Option 030

Option 890 Calibration Data

Extensive calibration data is now available on HP attenuators at low cost. When option 890 is specified for the fixed attenuators or microwave step attenuators, standardized calibration data from 100 MHz to the upper frequency of the unit is provided, in frequency steps no larger than 500 MHz. This data is generated from measurements made on an HP 8542 Automatic Network Analyzer and features excellent accuracy (traceable to NBS) and low cost (averages less than \$1 per frequency for three measurements). Data is given for attenuation and the SWR of each port and is provided in a protective plastic envelope.

Calibration data has important uses in applications such as RF substitution measurements and test system verification. Using the actual calibration data rather than data sheet specifications allows the attenuation uncertainty to be reduced 60% or more. Also, the calculated mismatch uncertainty for a test system is lower if the actual SWR data for the attenuators is used. Similar calibration data is used in HP production areas to verify the performance of manual and automated test systems. For automated system checkout, the calibrated unit is tested and the results are compared to the previously stored calibration data. If the differences are within the measurement uncertainty, proper operation is ensured. For step attenuators, the calibration data can be used in automated test systems to more accurately characterize a device's characteristics. By storing the calibration data for the individual steps, the measurement results can be adjusted by the actual amount of attenuation (for example, when a nominal 10 dB step is actually 9.6 dB).

The calibration data frequencies, prices, and ordering information for fixed attenuators are on the adjacent page, and the same information for step attenuators is on page 461.



8491A/B series



8492 series

Ordering example

Include appropriate frequency range/connector and attenuation designations from the ordering example below with every attenuator order.

Calibration Data

Include "Option 890" in addition to attenuation option when ordering calibration data.



8493A/B series

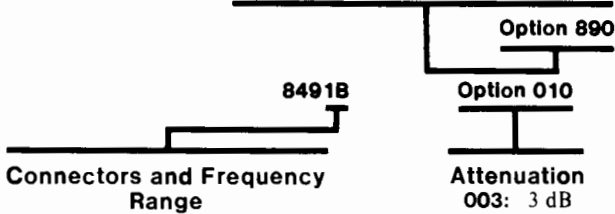

- Connectors and Frequency Range**
- 1A: Type N (m,f), dc-12.4 GHz
 - 1B: Type N (m,f), dc-18 GHz
 - 2A: APC-7, dc-18 GHz
 - 3A: SMA (m,f), dc-12.4 GHz
 - 3B: SMA (m,f), dc-18 GHz
 - 8A: Type N (m,f), dc-18 GHz
- 8498 is available in a 30 dB model only

- Attenuation**
- 003: 3 dB
 - 006: 6 dB
 - 010: 10 dB
 - 020: 20 dB
 - 030: 30 dB
 - 040: 40 dB*
 - 050: 50 dB*
 - 060: 60 dB*

* Not available for 8493A/B

Coaxial & Waveguide Catalog & Microwave Measurement Handbook

96 pages with over 350 measurement accessories. Request card at back of this catalog.

Ordering Information

- 11581A 3, 6, 10, 20 dB 8491A set
- Option 890 Calibration Data
- 11582A 3, 6, 10, 20 dB 8491B set
- Option 890 Calibration Data
- 11583A 3, 6, 10, 20 dB 8492A set
- Option 890 Calibration Data

Price

- \$415
- Add \$85
- \$510
- Add \$100
- \$920
- Add \$100

8491A/B, 8492A, 8493A/B, 8498A, Option 890 Specifications

Model	Frequency Range GHz	SWR Maximum	Maximum input Power	Attenuation Accuracy								Connector	Price (Specify option)
				3 dB (Option 003)	6 dB (Option 006)	10 dB (Option 010)	20 dB (Option 020)	30 dB (Option 030)	40 dB (Option 040)	50 dB (Option 050)	60 dB (Option 060)		
8491A 3-30 dB	dc-12.4	dc-8 GHz: 1.2 8-12.4 GHz: 1.3	2 W Avg. 100 W Peak	±0.3 dB	±0.4 dB	±0.6 dB	±0.6 dB	±1 dB	—	—	—	N(m,f)	\$90
				—	—	—	—	—	±1.5 dB	±1.5 dB	±2 dB		\$125
8491B 3-30 dB	dc-18	dc-8 GHz: 1.2 8-12.4 GHz: 1.3 12.4-18 GHz: 1.5	2 W Avg. 100 W Peak	±0.3 dB	±0.4 dB	±0.6 dB	±0.6 dB	±1 dB	—	—	—	N(m,f)	\$110
				dc-12.4 GHz: ±0.4 dB 12.4-18 GHz: ±0.5 dB	dc-12.4 GHz: ±0.4 dB 12.4-18 GHz: ±0.5 dB	±0.6 dB	dc-12.4 GHz: ±1.0 dB 12.4-18 GHz: ±1.0 dB	—	±1.5 dB	±1.5 dB	±2 dB		\$155
8492A 3-30 dB	dc-18	dc-8 GHz: 1.15 dc-12.4 GHz: 1.25 12.4-18 GHz: 1.35	2 W Avg. 100 W Peak	±0.3 dB	±0.4 dB	±0.6 dB	±0.6 dB	±1 dB	—	—	—	APC-7	\$200
				dc-12.4 GHz: ±0.4 dB 12.4-18 GHz: ±0.5 dB	dc-12.4 GHz: ±0.4 dB 12.4-18 GHz: ±0.5 dB	±0.6 dB	dc-12.4 GHz: ±1.0 dB 12.4-18 GHz: ±1.0 dB	—	±1.5 dB	±1.5 dB	±2 dB		\$250
8493A 3-20 dB	dc-12.4	dc-8 GHz: 1.2 8-12.4 GHz: 1.3	2 W Avg. 100 W Peak	±0.3 dB	±0.4 dB	±0.6 dB	±0.6 dB	—	—	—	—	SMA (m,f)	\$90
				—	—	—	—	±1 dB	—	—	—		—
8493B 3-20 dB	dc-18	dc-8 GHz: 1.2 8-12.4 GHz: 1.3 12.4-18 GHz: 1.5	2 W Avg. 100 W Peak	±0.3 dB	±0.4 dB	±0.6 dB	±0.6 dB	—	—	—	—	SMA(m,f)	\$110
				dc-12.4 GHz: ±0.4 dB 12.4-18 GHz: ±0.5 dB	dc-12.4 GHz: ±0.4 dB 12.4-18 GHz: ±0.5 dB	±0.6 dB	dc-12.4 GHz: ±1.0 dB 12.4-18 GHz: ±1.0 dB	—	—	—	—		±1 dB
8498A Option 030	dc-18	dc-2 GHz: 1.1 2-12.4 GHz: 1.2 12.4-18 GHz: 1.35	25 W Avg. 500 W Peak (dc-7 GHz) 125 W Peak (7-18 GHz) 500 Watt-µsec max. per pulse	—	—	—	—	±1 dB	—	—	—	N(m,f)	\$525
Option 890 Calibration Data Information				Models		Calibration Frequencies (MHz)					Option 890 Price		
				8491A, 8493A		100, 500, 1000, every 500 MHz to 12000, 12400, (26 frequencies)					add \$20		
				8491B, 8492A, 8493B, 8498A		Same as above plus 12500 to 16000 in 500 MHz steps, 16000 to 18000 in 250 MHz steps, (42 frequencies)					add \$25		



MICROWAVE TEST EQUIPMENT

Coaxial Step Attenuators

Models 355 series, 8494/5/6 series, 11713A, 11716A/B

- Excellent repeatability
- Manual and programmable
- Calibration data available

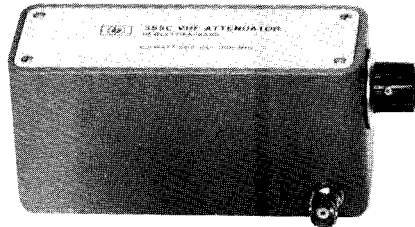

355C

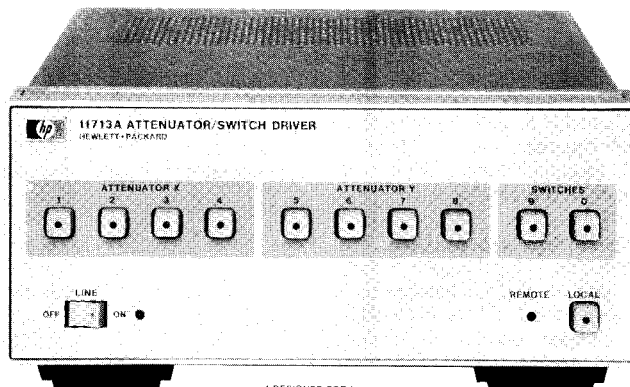

11713A



355C/D/E/F Manual and Programmable Step Attenuators, dc to 1000 MHz

Precision attenuation from dc to 1000 MHz is available with these Hewlett-Packard attenuators. Models 355C/E provide 0 to 12 dB in 1-dB steps and models 355D/F provide 0 to 120 dB in 10-dB steps. For the 355E and 355F models, attenuation programming is done through a 7-pin connector. All standard models are equipped with BNC connectors.

8494A/B/G/H, 8495A/B/D/G/H/K, 8496A/B/G/H Manual and Programmable Step Attenuators, dc to 26.5 GHz

Three attenuation ranges are available: 0 to 11 dB in 1-dB steps (Model 8494), 0 to 70 dB in 10-dB steps (Model 8495) and 0 to 110 dB in 10-dB steps (Model 8496). There is choice of three connectors Type N (f), SMA (f), and APC-7 (APC-3.5 on 8495D/K only). Manual and programmable versions are available as well as coverage of three frequency ranges (dc-4GHz, dc-18 GHz, and dc-26.5 GHz). Calibration data (SWR and attenuation) is available on the 8494/5/6 models as option 890. The data is generated by an automatic network analyzer test system and is given for each step of the attenuator at 14 frequencies (dc-4 GHz models) or 47 frequencies (dc-18 GHz models); see frequency lists on next page. This data is very useful for improving measurement accuracy in manual and automated test systems.

Each attenuator consists of three or four attenuation sections connected in cascade. Attenuator sections are inserted and removed by cam-actuated "edge line" contacts. These contacts are gold-plated leaf-springs that ensure long life (over a million steps) and high repeatability (typically 0.03 dB).

The G, H, and K programmable models offer the same high performance as the manual models with the addition of fast switching solenoids. Attenuation programming is done through a 12-pin connector. For ease of connection to the driving circuit, each attenuator is provided with a five-foot cable assembly that includes the mating con-

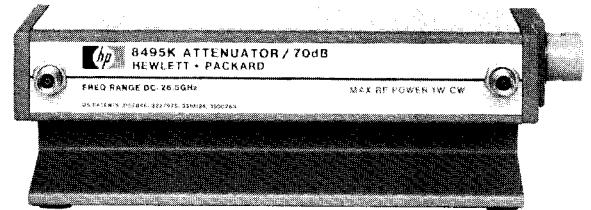

8495K option 004

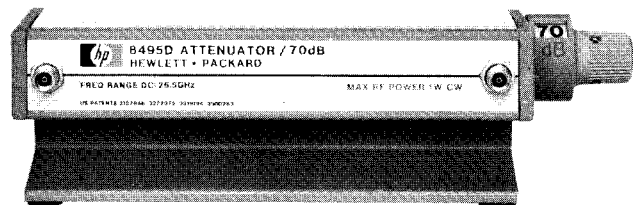

8495D option 004

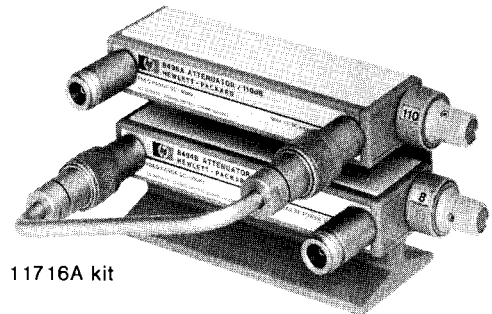

11716A kit

ductor. With the HP 11713A Attenuator Driver, the attenuators are easily integrated into a Hewlett-Packard Interface Bus (HP-IB) automated system.

11716A/B Interconnection Kit

Convenient interconnection of 1 dB and 10 dB models is provided with the 11716A/B. These kits provide a rigid RF cable, mounting bracket, and screws to connect any pair of 8494/5/6 attenuators in series (see picture above). Attenuators must be ordered separately.

Equivalent versions of these attenuators for incorporation in equipment (i.e., "OEM") are available under HP model numbers 33320, 33321, and 33322. See following pages.

11713A Attenuator/Switch Driver

This instrument has all of the necessary features to provide HP-IB control of up to two programmable attenuators of the 8494/5/6 or 33320/1/2 series and concurrently up to two electro-mechanical switches (e.g., 8761B or 33311 series). Alternatively, the 11713A can be used to supply +24 V common and ten pairs of transistor switches (total current less than 1.25A) to control up to ten relays. The 11713A includes an integral power supply with short circuit protection that can simultaneously provide 125 milliamps at 24 volts to all contacts for control of the attenuators and switches, so no external power supply is needed. For convenience in connecting 8490 or 33320-series attenuators, two 5-foot cables with appropriate connectors are supplied.

A local mode and front panel push buttons allow switches and attenuator sections to be operated manually. Switching time for the drivers is less than 10 milliseconds.

Ordering Information

	Price
11713A Attenuator/Switch Driver	\$1375
11716A Interconnection Kit for Type N (f) Connectors	\$160
11716B Interconnection Kit for APC-7 Connectors	\$225
11717A Attenuator/Switch Rack Mount Support Kit	\$25

How to Order the 8494/5/6 Series Attenuators

Each order must include basic model number, suffix letter, and connector option.

Optional calibration data.

8494 A Option 001 Option 890

4 (1dB step, 11 dB max)	A (Manual, dc—4 GHz)	001 (N-Female)
5 (10 dB step, 70 dB max)	B (Manual, dc—18 GHz)	002 (SMA Female)
6 (10dB step, 110 dB max)	D (Manual, dc—26.5 GHz)*	003 (APC-7)
	G (Programmable, dc—4 GHz)	004 (APC-3.5 Female)*
	H (Programmable, dc—18 GHz)	
	K (Programmable, dc—26.5 GHz)*	

* Option 004 is only available on 'D' and 'K' models.

355 Series, 8494/5/6 Series Specifications

Model and (Switching Mode)	Frequency Range (GHz)	Incremental Attenuation (dB)	SWR Maximum (50Ω Nominal)	Insertion Loss (0 dB setting)	Attenuation Accuracy	Power Rating, Minimum Life	Solenoid Voltage Speed Power	Size, Shipping Weight	Connector Options Available	Price
355C (Manual)	dc—1	0—12 1 dB steps	dc—0.25 GHz: 1.2 dc—0.5 GHz: 1.3 dc—1.0 GHz: 1.5	0.11 dB + 1.39 dB/GHz	±0.1 dB @ 1000 Hz ±0.25 dB: dc—0.5 GHz ±0.35 dB: dc—1.0 GHz	0.5 W avg 350 W peak 0.6 million steps	— 15—18 V <65 ms 3.0 W	67 H x 70 W x 152 mm D (2.6 x 2.75 x 6 in.) 1.4 kg (3 lb)	BNC (f) See Note 1	\$290 \$500
355E (Programmable)										
355D (Manual)	dc—1	0—120 10 dB steps	dc—0.25 GHz: 1.2 dc—0.5 GHz: 1.3 dc—1.0 GHz: 1.5	0.11 dB + 1.39 dB/GHz	±0.3 dB @ 1000 Hz ±1.5 dB to 90 dB, and ±3 dB to 120 dB @ 1 GHz	0.5 W avg 350 W peak 0.6 million steps	— 15—18 V <65 ms 3.0 W	67 H x 70 W x 152 mm D (2.6 x 2.75 x 6 in.) 1.4 kg (3 lb)	BNC (f) See Note 1	\$290 \$500
355F (Programmable)										
8494A (Manual)	dc—4	0—11 1 dB Steps	1.5	0.6 dB + 0.09 dB/GHz	±0.2 dB: 1—2 dB ±0.3 dB: 3—6 dB ±0.4 dB: 7—10 dB ±0.5 dB: 11 dB	1 W avg 100 W peak 10 μs max. 1 million steps	— 20—30 V <20 ms 2.7 W	43 H x 73 W x 159 mm D (1.7 x 2.9 x 6.2 in.) 0.9 kg (2 lb)	001 002 003 See Note 2	\$600 \$940
8494G (Programmable)										
8494B (Manual)	dc—18	0—11 1 dB steps	dc—8 GHz: 1.5 dc—12.4 GHz: 1.6 dc—18 GHz: 1.9	0.6 dB + 0.09 dB/GHz	dc—12.4 GHz ±0.3 dB: 1—2 dB ±0.4 dB: 3—4 dB ±0.5 dB: 5—6 dB ±0.6 dB: 7—10 dB ±0.7 dB: 11 dB dc—18 GHz ±0.7 dB: 1—5 dB ±0.8 dB: 6—9 dB ±0.9 dB: 10—11 dB	1 W avg 100 W peak 10 μs max. 1 million steps	— 20—30 V <20 ms 2.7 W	43 H x 73 W x 159 mm D (1.7 x 2.9 x 6.2 in.) 0.9 kg (2 lb) 43 H x 73 W x 142 mm D (1.7 x 2.9 x 5.6 in.)	001 002 003 See Note 2	\$775 \$1180
8494H (Programmable)										
8495A (Manual)	dc—4	0—70 10 dB steps	1.35	0.4 dB + 0.07 dB/GHz	±1.7% of setting or ±0.4 dB, whichever is greater	1 W avg 100 W peak 10 μs max. 1 million steps	— 20—30 V <20 ms 2.7 W	43 H x 73 W x 130 mm D (1.7 x 2.9 x 5.1 in.) 0.9 kg (2 lb)	001 002 003 See Note 2	\$435 \$780
8495G (Programmable)										
8495B (Manual)	dc—18	0—70 10 dB steps	dc—8 GHz: 1.35 dc—12.4 GHz: 1.5 dc—18 GHz: 1.7	0.4 dB + 0.07 dB/GHz	±3%: dc—12.4 GHz ±4%: dc—18 GHz % in dB from Atten. Setting	1 W avg 100 W peak 10 μs max. 1 million steps	— 20—30 V <20 ms 2.7 W	43 H x 73 W x 130 mm D (1.7 x 2.9 x 5.1 in.) 0.9 kg (2 lb)	001 002 003 See Note 2	\$570 \$875
8495H (Programmable)										
8495D (Manual)	dc—26.5	0—70 10 dB steps	dc—12.4 GHz: 1.6 12.4—18 GHz: 1.9 18—26.5 GHz: 2.2	0.5 dB + 0.13 dB/GHz	±3%: dc—12.4 GHz ±4%: dc—18 GHz ±7%: dc—26.5 GHz % in dB from Atten. Setting	1 W avg 100 W peak 10 μs max. 1 million steps	— 20-30 V <20 ms 2.7 W	43 H x 52 W x 159 mm D (1.7 x 2.1 x 6.2 in.) 0.9 kg (2 lb)	004 APC-3.5 See Note 2	\$850 \$1275
8495K (Programmable)										
8496A (Manual)	dc—4	0—110 10 dB steps	1.5	0.6 dB + 0.09 dB/GHz	±1.7% of setting or ±0.4 dB, whichever is greater	1 W avg 100 W peak 10 μs max. 1 million steps	— 20—30 V <20 ms 2.7 W	43 H x 73 W x 159 mm D (1.7 x 2.9 x 6.2 in.) 0.9 kg (2 lb)	001 002 003 See Note 2	\$600 \$940
8496G (Programmable)										
8496B (Manual)	dc—18	0—110 10 dB steps	dc—8 GHz: 1.5 dc—12.4 GHz: 1.6 dc—18 GHz: 1.9	0.6 dB + 0.09 dB/GHz	±3%: dc—12.4 GHz +4%: dc—18 GHz % in dB from Atten. Setting	1 W avg 100 W peak 10 μs max. 1 million steps	— 20—30 V <20 ms 2.7 W	43 H x 73 W x 159 mm D (1.7 x 2.9 x 6.2 in.) 0.9 kg (2 lb)	001 002 003 See Note 2	\$775 \$1180
8496H (Programmable)										
Option 890 Calibration Data Information		Option 890 Frequency List (MHz)				Models			Option 890 Price	
DC to 4 GHz Models: 100, 300, 500, 700, 900, 1000, 1250, 1500, 1750, 2000, 2500, 3000, 3500, 4000		DC to 18 GHz Models: Same as above to 4000 MHz, every 500 MHz to 16000 (plus 12400 MHz), every 250 MHz from 16000 to 18000.				8494A/G, 8496A/G, 33320A/G, 33322A/G 8495A/G, 33321A/G			add \$1.30 add \$110	
						8494B/H, 8496B/H, 33320B/H, 33322B/H 8495B/H, 33321B/H			add \$170 add \$150	
Note 1: 355C/D/E/F connector options (BNC (f) standard) Option 001 N(f) Option 005 TNC(f) Option 007 Transistor protection		Price add \$25 add \$10 add \$55				Note 2: 8494/5/6 orders must specify connector option. See ordering example above. Option 001 N(f) Option 002 SMA(f) Option 003 APC-7 Option 004 APC-3.5 (8495D/K only)			N/C N/C add \$55 N/C	

MICROWAVE TEST EQUIPMENT

Coaxial Single and Dual-Directional Couplers

Models 770 series, 790 series, 11691D, 11692D

- Broadband coverage
- High directivity
- Close tracking

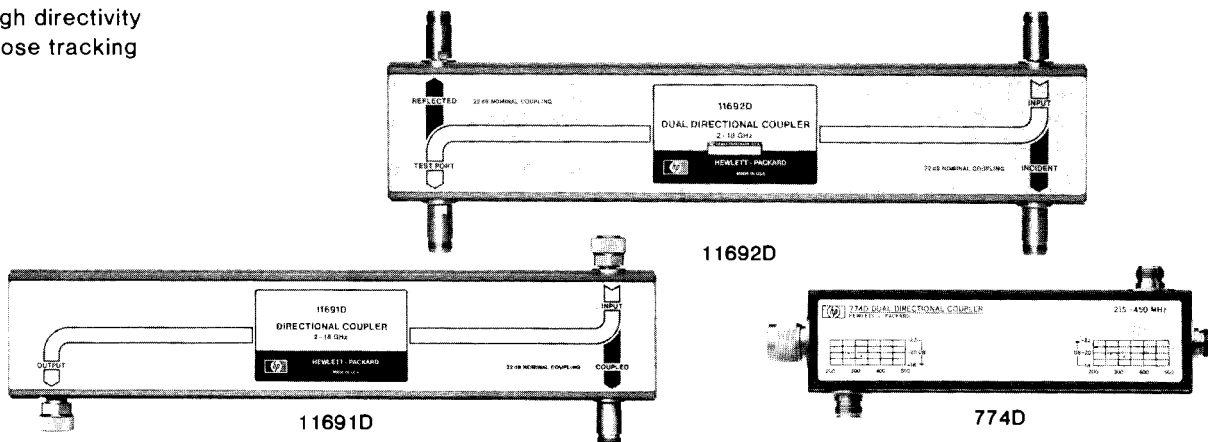

779D Directional Coupler

The HP 779D spans more than two octaves from 1.7 to 12.4 GHz with excellent directivity. With increased coupling factor (typically 24 dB), the 779 is useful down to 500 MHz. Upper frequency usefulness extends to 18 GHz with directivity reduced to about 15 dB. Various connector options are available.

790 Series Directional Couplers (Octave Bands)

The 790 directional couplers are ultra-flat, high directivity couplers which are ideal for power-monitoring applications in coaxial systems. Output coupling (ratio of output power from main and auxiliary arms) is specified rather than coupling factor. Thus, no correction factor is required to account for insertion loss in the main arm.

11691D Directional Coupler

The 11691D is an ultra-wide-band single-directional coupler covering 2 to 18 GHz with high directivity. It is useful as a power monitoring or leveling coupler, or for making reflection measurements. Couplers are preferred over broadband bridges in reflectometer applications in situations where the power level of the source is limited, or where simultaneous measurement of return loss and insertion loss is desired.

779D, 790 Series, 11691D Specifications

Model	Frequency Range (GHz)	Mean Output Coupling (dB)	Output Coupling Variation (dB)	Minimum Directivity (dB)	Equivalent ¹ Source Match	Price
779D	1.7-12.4	20 ± 0.5	±0.75	1.7-4 GHz: 30 4-12.4 GHz: 26	1.2	\$825
796D	0.96-2.11	20 ± 0.5	±0.2	30	1.13	\$500
797D	1.9-4.1	20 ± 0.5	±0.2	26	1.16	\$500
798C	3.7-8.3	10 ± 0.3	±0.3	20	1.25	\$575
11691D	2-18	22 Nominal	±1.0	2-8 GHz: 30 dB 8-18 GHz: 26 dB	1.2	\$1190

796D-798C Standard connectors
Primary Line: N(f), N(m)
Auxiliary Arm: N(f)

779D Standard connectors
Primary Line: N(m) input, N(f) output; auxiliary arm: N(f)

Option 010: Primary Line: N(f) input, N(m) output; auxiliary output: N(f)
Other options: APC-7 on any or all ports

11691D Standard connectors
Primary line: APC-7, APC-7; Auxiliary Arm: N(f)

Option 001: All N(f) less \$30
Option 005: All APC-7 add \$25

¹Apparent SWR at the output port of a coupler when used in a closed-loop leveling system.

774D-777D Dual-Directional Couplers (Octave Bands)

The economical 774D-777D couplers cover frequency spreads of more than two-to-one, each centered on one of the important VHF/UHF bands. With their high directivity and a mean coupling accuracy of ±0.5 dB, these couplers are ideal for reflectometer applications. Furthermore, the close tracking of the auxiliary arms makes these couplers particularly useful for reflectometers driven by externally leveled sweep oscillators such as the HP 8690B and 8620C. Power ratings are 50 W average, 500 W peak.

778D, 11692D Dual-Directional Couplers (Multi-Octave Bands)

These couplers are ideal for swept-frequency reflectometer testing of broadband coaxial components. The 778D covers 100 MHz to 2 GHz and the 11692D covers 2 to 18 GHz. High directivity and close tracking of the auxiliary arms are featured. Various connector options are available. Both couplers handle 50 W average power. Peak power: 778D, 500W; 11692D, 250 W.

774D, 775D, 776D, 777D, 778D, 11692D Specifications

Model	Frequency Range (GHz)	Nominal Coupling (dB)	Maximum Coupling Variation (dB)	Minimum Directivity (dB)	SWR Primary Line Maximum (50% Nom.)	Price
774D	0.215-0.450	20	±1	40	1.15	\$610
775D ¹	0.450-0.940	20	±1	40	1.15	\$625
776D ¹	0.940-1.90	20	±1	40	1.15	\$610
777D	1.90-4.0	20	±0.4	30	1.2	\$715
778D	0.10-2.0	20	±1	0.1-1 GHz: 36 ² 1-2 GHz: 32	1.1	\$725
11692D	2.0-18.0	22	±1 incident to test port	2-8 GHz: 30 8-18 GHz: 26 ³	2-12.4 GHz: 1.3 12.4-18 GHz: 1.4	\$2050

774D-777D Standard connectors
Primary Line: N(m), N(f)
Auxiliary Arm: N(f), N(f)

778D Standard connectors
Primary Line: N(m), N(f); Auxiliary Arms: N(f), N(f)

Option 011: Primary Line, APC-7, N(f) add \$25
Option 012: Primary Line, N(m), N(f) N/C

11692D Standard connectors
Primary line: N(f), APC-7; Auxiliary Arms: N(f), N(f)

Option 001: Primary Line, N(f), N(f) less \$15
Option 002: Primary Line, N(f), N(m) less \$15

¹Maximum auxiliary arm tracking: 0.3 dB for 776D; 0.5 dB for 777D.
²30 dB, 0.1 to 2 GHz, input port.
³24 dB with Type N connector on the test port.

- Flat frequency response
- Low equivalent source match
- High directivity to >40 dB

- Low SWR
- Coverage to 40 GHz

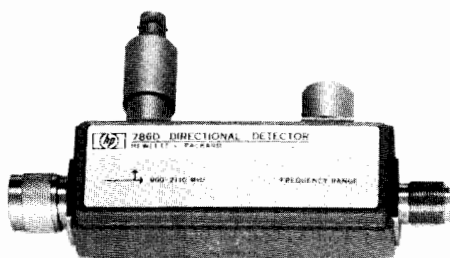

786D

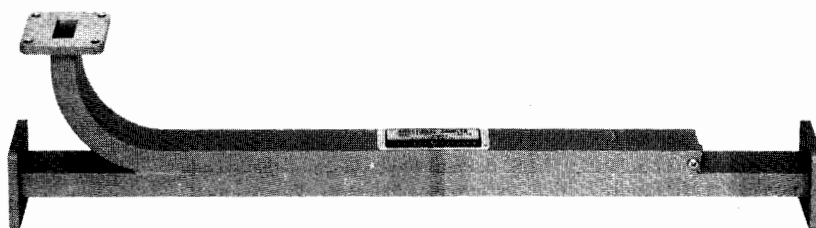

X752A

780 Series Directional Detectors

The 780 series detectors are directional couplers with built-in crystal detectors. The couplers have flat frequency response and good directivity, while the detectors have good frequency response plus high sensitivity. The configuration of the directional detector reduces the number of ambiguities over the standard system of separate coupler and detector and makes possible tighter correlation between main-arm power and detected signal. The directional detector is well suited for sweep oscillator leveling and can also be used to monitor power with a voltmeter or oscilloscope.

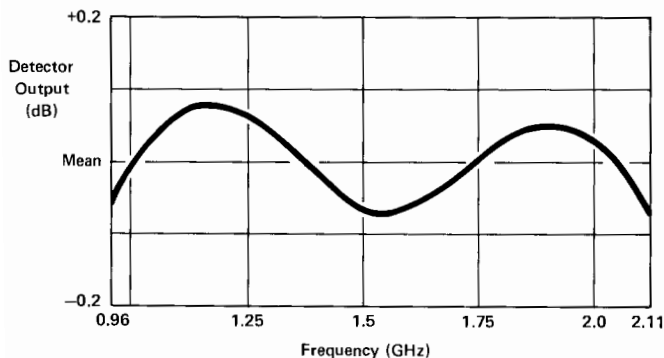

Figure 1. Typical 786D Frequency Response.

780 Series specifications

Standard Connectors

Output: All models, N (f)

Input: 786D-788C, N (m); 789C, N (f)

Model	Frequency Range (GHz)	Frequency ¹ Response	Equivalent ² Source Match	Price
786D	0.96-2.11	±0.2	1.13	\$625
787D	1.9-4.1	±0.2	1.16	\$625
788C	3.7-8.3	±0.3	1.25	\$775
789C	8-12.4	±0.5	1.25	\$950

¹Includes coupler and detector variation with frequency as read on a meter calibrated for square-law detector (e.g., HP 415E).

²Apparent SWR at the output port of the directional detector when used in a closed-loop leveling system.

752 Series Waveguide Directional Couplers

The HP 752 series couplers are specified to meet a wide variety of microwave applications. Every coupler has a minimum directivity of 40 dB over its entire frequency range. Each coupler is swept-frequency tested to ensure that the main guide SWR and directivity specifications are accurate. Performance characteristics are unaffected by humidity, temperature, and time, making these units especially useful in microwave "standards" measurements.

The 752 couplers are an essential part of many waveguide measurement systems. Attenuation measurements, reflectometer setups, power measurements, source leveling and network analysis are just a few areas in which these couplers are used.

752 Series Specifications

Model	Frequency Range (GHz)	Nominal Coupling (dB)	Mean Coupling Accuracy (dB)	Maximum Coupling Variation (dB)	Minimum Directivity (dB)	Waveguide & Flange	Price
J752A	5.85-8.2	3	±0.4	±0.5	40	WR137 UG-441/U	\$950
J752C	5.85-8.2	10	±0.4	±0.5	40		\$950
J752D	5.85-8.2	20	±0.4	±0.5	40		\$950
H752A	7.05-10.0	3	±0.4	±0.5	40	WR112 UF-138/U	\$710
H752C	7.05-10.0	10	±0.4	±0.5	40		\$710
H752D	7.05-10.0	20	±0.4	±0.5	40		\$710
X752A	8.2-12.4	3	±0.4	±0.5	40	WR90 UG-135/U	\$530
X752C	8.2-12.4	10	±0.4	±0.5	40		\$530
X752D	8.2-12.4	20	±0.4	±0.5	40		\$530
P752A	12.4-18.0	3	±0.4	±0.5	40	WR62 UG-419/U	\$510
P752C	12.4-18.0	10	±0.4	±0.5	40		\$535
P752D	12.4-18.0	20	±0.4	±0.5	40		\$510
K752A	18.0-26.5	3	±0.7	±0.5	40	WR42 UG-595/U	\$650
K752C	18.0-26.5	10	±0.7	±0.5	40		\$650
K752D	18.0-26.5	20	±0.7	±0.5	40		\$650
R752A	26.5-40.0	3	±0.7	±0.5	40	WR28 UG-599/U	\$700
R752C	26.5-40.0	10	±0.7	±0.5	40		\$700
R752D	26.5-40.0	20	±0.7	±0.6	40		\$700

MICROWAVE TEST EQUIPMENT

Coaxial Crystal Detectors

Models 420C, 423A/B, 8470A/B, 8471A, 8472A, 8473B/C, 33330B/C

- Flat frequency response
- High burnout protection

- Low SWR
- Field replaceable detector elements



33330B



8470B Opt 012



423B



8470B



423A



8470A



8472A



8471A

423A, 8470A, 8471A, 8472A Point-Contact Detectors

These point-contact detectors have been widely used for many years and provide high performance at an economical price. The 8470A, 8470A Opt 012, and 8472A provide APC-7, Type N, and SMA connector versions to 18 GHz. Matched pairs are available for applications requiring close detector tracking, and all but the 8472A can be supplied with video loads for optimum conformance to square law.

423B, 8470B, 8473B/C, 33330B/C Low Barrier Schottky (LBS) Detectors

The low-barrier Schottky (LBS) detectors are a state-of-the-art addition to the HP family of high performance detectors. Various models provide coverage to 12.4, 18, and 26.5 GHz and input connectors are Type N, APC-7, or APC-3.5 depending on frequency range. Output connector is BNC (f) except for the 33330B/C (SMC).

Matched pairs (Opt 001), square law load (Opt 002), and positive polarity output (Opt 003) are available for most models.

Coaxial & Waveguide Catalog & Microwave Measurement Handbook

96 pages with over 350 measurement accessories. Use request card at back of this catalog.

Coaxial Crystal Detector Specifications

Model	Frequency Range (GHz)	Frequency Response (dB)	SWR Maximum (50Ω Nom.)	Low Level Sensitivity	Maximum Input (Peak or Average)	Short-Term Maximum Input (<1 min.)	Option 001 Matched Pair (order 2 units for each pair)	Options Available	Input Connector	Output Connector	Price
420C	0.01-12.4 Point Contact	±2	2.0	>0.15 mV/μW	100 mW	0.1 watt	±1 dB	001 003	N (m)	BNC (f)	\$110
423B	0.01-12.4 LBS	±0.2/octave to 8 GHz ±0.3 overall	<1.15 to 4 GHz <1.3 to 12.4 GHz	>0.5 mV/μW	200 mW	1 watt	±0.2 dB to 12.4 GHz	001 002	N (m)	BNC (f)	\$225
423A	0.01-12.4 Point Contact	±0.2/octave to 8 GHz ±0.5 overall	<1.2 to 4.5 GHz <1.35 to 7 GHz <1.5 to 12.4 GHz	>0.4 mV/μW	100 mW	0.1 watt	±0.2 dB to 8 GHz ±0.3 dB to 12.4 GHz	001 002 003	N (m)	BNC (f)	\$175
8470B	0.01-18.0 LBS	±0.2/octave to 8 GHz ±0.3 to 12.4 GHz ±0.6 to 18 GHz	<1.15 to 4 GHz <1.3 to 15 GHz <1.4 to 18 GHz	<0.5 mV/μW	200 mW	1 watt	±0.2 dB to 12.4 GHz ±0.3 dB to 18 GHz	001 002 003	APC-7	BNC (f)	\$275
8470B Opt 012									N (m)	BNC (f)	\$265
8470A	0.01-18.0 Point Contact	±0.2/octave to 8 GHz ±0.5 to 12.4 GHz ±1.0 to 18 GHz	<1.2 to 4.5 GHz <1.35 to 7 GHz <1.5 to 12.4 GHz <1.7 to 18 GHz	>0.4 mV/μW	100 mW	0.1 watt	±0.2 dB to 8 GHz ±0.3 dB to 12.4 GHz ±0.6 dB to 18 GHz	001 002 003	APC-7	BNC (f)	\$215
8470A Opt 012									N (m)	BNC (f)	\$200
8473B	0.01-18.0 LBS	±0.2/octave to 8 GHz ±0.6 to 18 GHz	<1.2 to 12.4 GHz <1.5 to 18 GHz	>0.5 mV/μW	200 mW	1 watt	±0.2 dB to 12.4 GHz ±0.3 dB to 18 GHz	001 003	APC-3.5 (m)	BNC (f)	\$255
8473C	0.01-26.5 LBS	±0.6 to 20 GHz ±1.5 with a -3.5 dB slope. 20 to 26.5 GHz	<1.2 to 4 GHz <1.5 to 18 GHz <2.2 to 26.5 GHz	>0.5 mV/μW to 18 GHz >0.18 mV/μW to 26.5 GHz	200 mW	1 watt	±0.2 dB to 12.4 GHz ±0.3 dB to 18 GHz ±0.5 dB to 26.5 GHz	001 003	APC-3.5 (m)	BNC (f)	\$300
8472A	0.01-18.0 Point Contact	±0.2/octave to 8 GHz ±0.5 to 12.4 GHz	<1.2 to 4.5 GHz <1.35 to 7 GHz <1.5 to 12.4 GHz <1.7 to 18 GHz	>0.4 mV/μW	100 mW	0.1 watt	±0.2 dB to 8 GHz ±0.3 dB to 12.4 GHz ±0.6 dB to 18 GHz	001 003	SMA (m)	BNC (f)	\$200
33330B	0.01-18.0 LBS	±0.6	<1.5	>0.5 mV/μW	200 mW	1 watt	±0.3 dB	001 003	APC-3.5 (m)	SMC (m)	\$250
33330C	0.01-26.5 LBS	±0.6 to 20 GHz ±1.5 with a -3.5 dB slope 20 to 26.5 GHz	<1.5 to 18 GHz <2.2 to 26.5 GHz	>0.5 mV/μW to 18 GHz Degrades to 0.18 mV/μW at 26.5 GHz	200 mW	1 watt	±0.3 dB to 18 GHz ±0.5 dB to 26.5 GHz	001 003	APC-3.5 (m)	SMC (m)	\$285
8471A	100 kHz-1.2 GHz Point Contact	±0.6 (typical) ±0.1/100 MHz	1.3 (typical) 50Ω	>0.35 mV/μW	3 V rms	3 V rms	No	004 005 006	BNC (m)	BNC (f)	\$80

Options

Option 001: Extra Detector—selected to have matching response to standard detector.

Option 002: Optimum square law load.

Option 003: Positive polarity output.

Model 8471A

004: positive output

005: 75 ohm negative output

006: 75 ohm positive output

N/C
add \$10
add \$10

Point Contact Detectors				Low Barrier Schottky Diodes			
Model	Opt. 001	Opt. 002	Opt. 003	Model	Opt. 001	Opt. 002	Opt. 003
420C	add \$150	n/a	N/C	423B	add \$275	add \$25	add \$35
423A	add \$225	add \$25	N/C	8470B	add \$325	add \$25	add \$35
8470A	add \$265	add \$25	N/C	8472B	add \$320	n/a	add \$35
8472A	add \$240	n/a	N/C	8473B	add \$305	n/a	add \$35
				8473C	add \$350	n/a	add \$35
				33330B	add \$290	n/a	add \$30
				33330C	add \$325	n/a	add \$30

MICROWAVE TEST EQUIPMENT

Waveguide Crystal Detectors; Frequency Meters

Models 422A, 424A, 532 Series, 536A, 537A

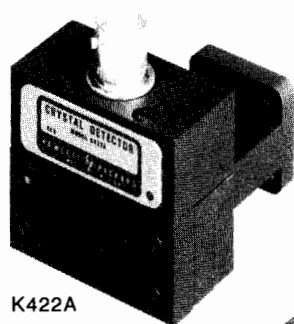

K422A

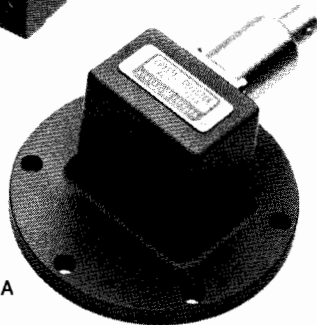

J424A

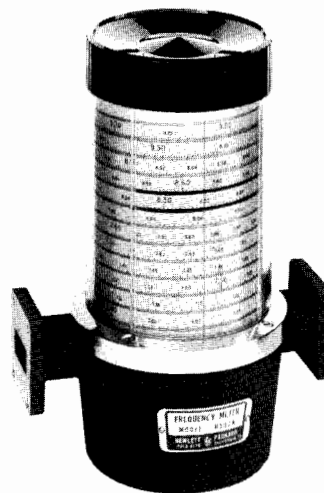

H532A

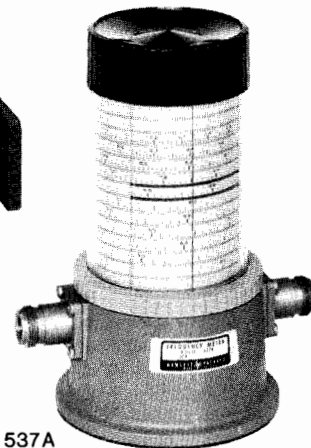

537A

422 Series, 424 Series Crystal Detectors

The 422A and 424A families of crystal detectors combine high sensitivity with flat frequency response and low SWR to provide waveguide band coverage from 3.95 to 40 GHz. They deliver between 0.2 and 0.4 mV/ μ W output at low level and handle 100 mW peak input. SWR ranges from 1.35 at G-band to 3 at R-band.

For reflectometer applications in which both flat frequency response and square-law characteristics are important, these models can be supplied as matched pairs (Option 001) and an optimum square-law load (Option 002).

422 Series, 424 Series Waveguide Crystal Detector Specifications

Model	Frequency Range (GHz)	Frequency Response (dB)	Option 001 Matched Pair Tracking (dB)	Option 003 Positive Output Available	Waveguide & Equivalent Flange	Price
G424A	3.95-5.85	± 0.2	± 0.2 dB	Yes	WR187 UG-407/U	\$275
J424A	5.2-8.2	± 0.2	± 0.2 dB	Yes	WR137 UG-441/U	\$275
H424A	7.05-10.0	± 0.2	± 0.2 dB	Yes	WR112 UG-138/U	\$275
X424A	8.2-12.4	± 0.3	± 0.3 dB	Yes	WR90 UG-135/U	\$250
M424A	10.0-15.0	± 0.5	± 0.5 dB	Yes	WR75 Cover	\$325
P424A	12.4-18.0	± 0.5	± 0.5 dB	Yes	WR62 UG-419/U	\$275
K422A	18.0-26.5	± 2	± 1 dB	No	WR42 UG-595/U	\$665
R422A	26.5-40.0	± 2	± 1 dB	No	WR28 UG-599/U	\$665

Option 001: extra detector, selected to have matching response to standard detector.
Option 002: optimum square-law load.
Option 003: positive polarity output.

Option Prices

Model	Opt. 001	Opt. 002	Opt. 003
G424A	add \$315	add \$20	N/C
H424A	add \$315	add \$20	N/C
J424A	add \$315	add \$20	N/C
K422A	add \$755	add \$20	N/C
M424A	add \$365	add \$20	N/C
P424A	add \$315	add \$20	N/C
R422A	add \$755	add \$20	N/C
S424A	add \$365	add \$20	N/C
X424A	add \$290	add \$20	N/C

532 Series, 536A, 537A Frequency Meters

These direct-reading frequency meters measure frequencies from 5.30 to 40 GHz in waveguide and from 960 MHz to 12.4 GHz in coax quickly and accurately. Their long scales and numerous calibration marks provide high resolution which is particularly useful when measuring frequency differences or small frequency changes. Frequency is read directly in GHz so neither interpolation nor charts are required.

The instruments comprise a special transmission section with a high-Q resonant cavity which is tuned by a choke plunger. A 1 dB or greater dip in output indicates resonance; virtually full power is transmitted off resonance. Overall accuracy of each frequency meter includes allowance for 0 to 100 percent relative humidity and temperature variation from 13 to 33°C. Except for the J532A, there are no spurious modes or resonances.

Coaxial & Waveguide Catalog Microwave Measurement Handbook

96 pages with over 350 measurement accessories. Request card at back of this catalog.

532 Series, 536A and 537A Specifications

Model	Frequency Range (GHz)	Overall Accuracy (%)	Calibration Increment (MHz)	W/G-Coax Equivalent Flange (Connector)	Price
536A	0.96-4.20	0.96 to 1 GHz: 0.22 1 to 4.2 GHz: 0.17	2	Coax Type N(f)	\$1240
537A	3.7-12.4	0.170	10	Coax Type N (f)	\$900
J532A	5.30-8.20	0.065	2	WR137 UG-441/U	\$1675
H532A	7.05-10.0	0.075	2	WR112 UG-138/U	\$1675
X532B	8.20-12.4	0.080	5	WR90 UG-39/U	\$875
P532A	12.4-18.0	0.100	5	WR62 UG-419/U	\$875
K532A	18.0-26.5	0.110	10	WR42 UG-595/U	\$1190
R532A	26.5-40.0	0.120	10	WR28 UG-599/U	\$1150

MICROWAVE TEST EQUIPMENT

Slotted Lines, Carriage, Probes

Models 440A, 442B, 444A, 447B, 448B, 805C, 809C, 810B series, 816A, 817B

- Precision reflection measurements 0.5 to 18 GHz

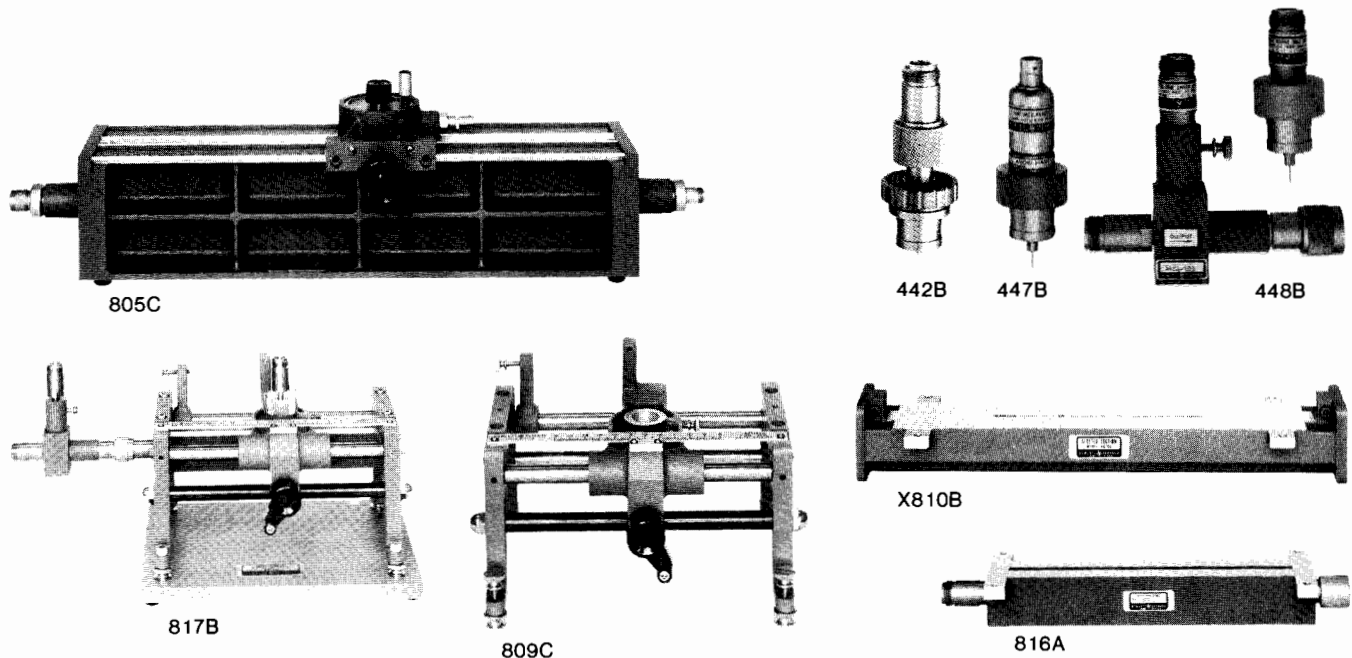

805C Coaxial Slotted Line System, 0.5 to 4 GHz

Model 805C slotted line system, employs 5 parallel ground planes and a rigid center conductor. This configuration has negligible slot radiation and is less sensitive to probe depth. The probe is tunable from 500 to 4000 MHz.

817B Coaxial Swept Slotted Line System, 1.8 to 18 GHz

817B fully tested system provides comprehensive swept frequency reflection data with the accuracy inherent in slotted lines. 817B consists of the 816A line, 809C carriage, and the 448B sweep adapter which accepts the detectors of the HP8755 Frequency Response Test Set.

805C, 817B Specifications

Model	Frequency Range (GHz)	SWR Residual	Connectors	Remarks	Price
805C	0.5-4.0	1.04	AN(m) N(f)	11512A N(m) short, 11511A N(f) short furnished	\$2150
817B	1.8-18.0	1.06	APC-7 N(f)	11512A N(m) short, 11565A APC-7 short furnished	\$2175
817B Options	001: APC-7 connectors on 448B probes				add \$55
	022: N(m) and N(f) connectors on 816A slotted section				less \$15

809C Slotted Line Carriage

The 809C carriage operates with the 816A coaxial slotted section and four 810B waveguide slotted sections. It is compatible with the 442B, 444A, 447B, and 448B coaxial probes. The carriage has a centimeter scale with a vernier reading to 0.1 mm, and provision is made also for mounting a dial gauge if more accurate probe position reading is required.

810B Series, 816A Slotted Sections

810B waveguide and 816A coaxial slotted sections are used with the 809C carriage. The 810B waveguide sections accept the 444A untuned probe or the 442B probe plus 440A tuned detector. The 816A coaxial line accepts the 447B probe or the 448B adapter sets.

810B Series, 816A Specifications

Model	Frequency Range (GHz)	SWR Residual	WG & Flange or Coax Conn.	Remarks	Price	
J810B	5.3-8.2	1.01	WR 137 UG-441/U	Use with 809C Carriage, 444A or 442B + 440A Probes	\$750	
H810B	7.05-10.0	1.01	WR 112 UG-138/U		\$550	
X810B	8.2-12.4	1.01	WR 90 UG-135/U		\$750	
P810B	12.4-18.0	1.01	WR 62 UG-419/U	Use with 809C carriage 444A Probe	\$550	
816A	1.8-18.0	1.02-1.04	Coaxial APC-7 N(f)	11512A N(m) Short 11565A APC-7 Short	\$800	
Opt 011			Both APC-7	furnished	Use with	Add \$25
Opt 022			N(m), N(f)		809C Carriage 447B Probe or 448B Sweep Adapter	Less \$15

440A, 442B, 444A, 447B, 448B Probes/Adapters

440A is a tunable mount (1N21 crystal not supplied) for 2.4-12.4 GHz, to be used on the 442 broadband probe. 442B fits the 809C carriage and provides sampled rf at a Type N jack.

444A is an untuned probe for 2.6-18 GHz for use with the 809C carriage or other 3/4 inch (19 mm) mounting hole and the 810B waveguide sections. 447B is similarly used with the 809C and the 816A coaxial section for 1.8 to 18 GHz.

448B sweep adapter probe has Type N connectors for mating with the detectors of the HP8755 Frequency Response Test Set.

Coaxial & Waveguide Catalog

96 pages with over 350 measurement accessories. Use request card at back of this catalog.

Ordering Information

440A	Detector mount	\$275
442B	RF probe	\$215
444A	Untuned probe	\$215
447B	Detector probe	\$300
448B	Slotted line sweep adapter probes 1.8-18 GHz	\$650
809C	Slotted line carriage	\$750

MICROWAVE TEST EQUIPMENT

Coaxial and Waveguide Terminations

Models 905, 907-911, 914, 920, 923, 930

467



- Precision loads and shorts for measurements to 40 GHz

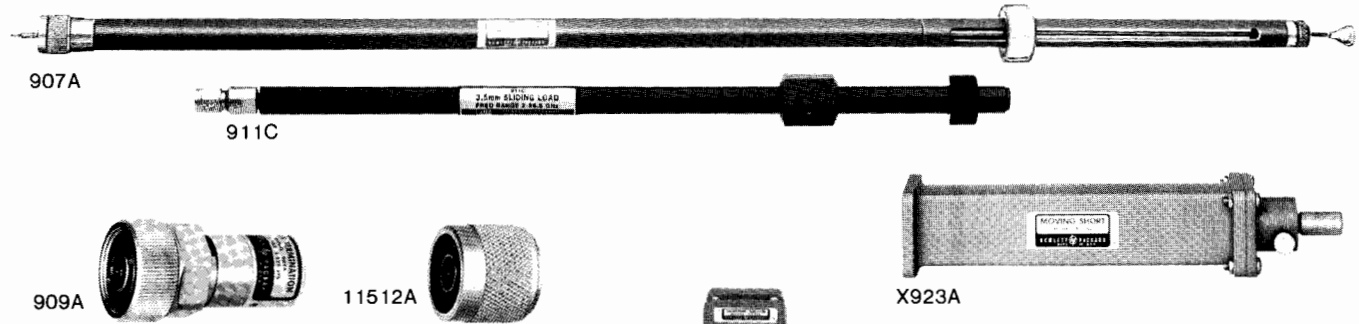

905A, 907A, 911A, 911C Coaxial Sliding Loads

The 905A, 907A and 911A are movable, low reflection 50Ω loads for precision measurements. The 905A and 907A are supplied with three interchangeable connectors, N-male, N-female and APC-7. The 911A is supplied with SMA male and female.

The 911C is a sliding load designed for 3.5 mm coaxial transmission lines and uses the APC-3.5 connector. This permits mode-free operation to 26.5 GHz. The 911C is furnished with interchangeable male and female connectors in a carrying case.

905A, 907A, 911A, 911C Specifications

HP Model	Frequency range (GHz)	Load SWR	Power rating	Length (mm) in.	Shipping weight	Price
905A	1.8-18	1.05	1 W avg. 5 kW pk	(440) 17.25	(1.4 kg) 3 lb	\$500
907A	1-18	1.1, 1-1.5 GHz; 1.05, 1.5-18 GHz	1 W avg. 5 kW pk	(778) 30.62	(4.1 kg) 9 lb	\$900
911A	2-18	1.1, 2-4 GHz; 1.05, 4-18 GHz	1 W avg. 5 kW pk	(380) 14.87	(1.4 kg) 3 lb	\$490
911C	2-26.5	1.2, 2-10 GHz; 1.07, 10-26.5 GHz	1 W avg. 5 kW pk	(266) 10.5	(1.7 kg) 3.8 lb	\$900

908A, 909A Coaxial Fixed Terminations

The 908A and 909A terminations are low-reflection loads for terminating 50Ω coaxial systems in their characteristic impedance.

908A, 909A Specifications

HP Model	Frequency Range (GHz)	Impedance	SWR	Power Rating	Connector	Price
908A	dc-4	50 ohms	1.05	½ W avg. 1 kW pk	N male	\$75
909A	dc-18	50 ohms	1.05, 0-4 GHz; 1.1, 4-12.4 GHz; 1.25, 12.4-18 GHz	2 W avg. 300 W pk	APC-7	\$135
909A Option 012 and Option 013	dc-18	50 ohms	1.06, 0-4 GHz; 1.11, 4-12.4 GHz; 1.3, 12.4-18 GHz	2 W avg. 300 W pk	Opt. 012 N male Opt. 013 N female	Less \$15

920A/B, X923A, X930A Waveguide Shorts

The 920A/B are movable shorts, adjustable through at least half a wavelength at the low end of the band. The X923A is also a movable short, but is adjustable through about two wavelengths at 8.2 GHz.

The X930A is a shorting switch. SWR is less than 1.02 in the "through" position and greater than 125 in the "short" position.

920A/B, X923A, X930A Specifications

Model	Frequency Range (GHz)	Waveguide Size EIA	Price
J920A	5.3-8.2	WR137	\$315
H920A	7.05-10.0	WR112	\$425
X923A	8.2-12.4	WR90	\$400
P920B	12.4-18	WR62	\$415
K920B	18.0-26.5	WR42	\$590
R920B	26.5-40.0	WR28	\$550
X930A	8.2-12.4	WR90	\$590

910A/B, 914A Waveguide Fixed and Movable Terminations

The 910A/B are fixed terminations for waveguide systems. The 914A/B are similar to the 910A/B, except that their absorptive elements are movable and locking plungers control the position of the elements.

910A/B, 914A/B Specifications

Model	Frequency Range (GHz)	SWR	Power Rating	Type	Waveguide Size (EIA)	Price
J910A	5.3-8.2	1.02	1 watt	fixed	WR137	\$250
H910A	7.05-10.0	1.02	1 watt	fixed	WR112	\$165
X910B	8.2-12.4	1.015	1 watt	fixed	WR90	\$175
P910A	12.4-18	1.02	1 watt	fixed	WR62	\$145
J914A	5.3-8.2	1.01	2 watt	sliding	WR137	\$525
H914A	7.05-10.0	1.01	1 watt	sliding	WR112	\$500
X914B	8.2-12.4	1.01	1 watt	sliding	WR90	\$375
P914A	12.4-18	1.01	½ watt	sliding	WR62	\$375
K914B	18-26.5	1.01	½ watt	sliding	WR42	\$590
R914B	26.5-40	1.01	½ watt	sliding	WR28	\$550

11511A, 11512A, 11565A Coaxial Shorts

These shorts are used for establishing measurement planes for known reflection phase and magnitude in 50Ω and 75Ω coaxial systems for various connectors.

Ordering Information

11511A N-female short (50 ohm)	\$35
1250-1531 N-female short (75 ohm)	\$19
11512A N-male short (50 ohm)	\$35
1250-1530 N-male short (75 ohm)	\$27
11565A APC-7 short (50 ohm)	\$75
0960-0054 SMA-female short (50 ohm)	\$26
0960-0055 SMA-male short (50 ohm)	\$25

Coaxial & Waveguide Catalog & Microwave Measurement Handbook

96 pages with over 350 measurement accessories. Request card at back of this catalog.

MICROWAVE TEST EQUIPMENT

Filters, Mixers, and Tuners

Models 360 series, 362 series, 870A, P932A, 934A

- Effective elimination of undesirable signals
- Low insertion loss through passband



X362A



360D

360 Series Coaxial Low Pass Filters, 362 Series Waveguide Low Pass Filters

These Hewlett-Packard low-pass filters facilitate microwave measurements by eliminating undesirable signals (such as harmonics) from the measurement system. Suppression of such signals is particularly important in applications such as broadband reflection and transmission measurements or slotted line measurements, where harmonics generated by the signal source could otherwise impair measurement accuracy.

X870A, P870A Waveguide Slide-Screw Tuners

Waveguide slide-screw tuners are used primarily for correcting discontinuities or for "matching" waveguide systems. X870A covers 8.2-12.4 GHz in WR 90 waveguide and P870A covers 12.4-18.0 GHz in WR 62 waveguide. Both can correct a SWR of 20 to a value of 1.02, with a maximum loss of 2 dB.

- Correct waveguide discontinuities
- Measure microwave frequencies

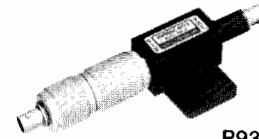

P932A

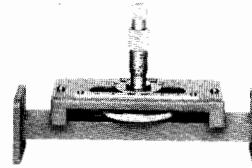

X870A

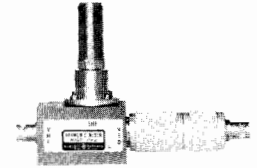

934A

934A, P932A Harmonic Mixers

These mixers can be used for frequency measurements and phase lock applications from 2 to 18 GHz. Both accept stable VHF signals from 100 to 1000 MHz and provide broadband, high sensitivity mixing with microwave signals. 934A handles coaxial inputs from 2 to 12.4 GHz while P932A mixes signals from 12.4 to 18 GHz in WR 62 waveguide. With 0 dBm input signal 934A provides 1.4 mV p-p output and P932A 0.4 mV p-p.

Coaxial and Waveguide Catalog

96 pages with over 350 measurement accessories. Use request card at back of this catalog.

Ordering Information

	Price
X870A Waveguide tuner	\$625
P870A Waveguide tuner	\$650
P932A Waveguide harmonic mixer	\$690
934A Coaxial harmonic mixer	\$425

360 Series Coaxial Filter Specifications

Model	Cut-off Frequency (MHz)	Insertion Loss	Rejection	Impedance	VSWR Maximum	Connectors	Overall Length mm (in)	Shipping Weight kg (lb)	Price
360A	700	Less than 1 dB below 0.9 times cut-off frequency	Greater than 50 dB at 1.25 times cut-off frequency	50Ω	<1.6 to within 100 MHz of cut-off	N (m, f)	276 (10.9)	0.9 (2)	\$315
360B	1200			50Ω	<1.6 to within 200 MHz of cut-off	N (m, f)	183 (7.2)	0.9 (2)	\$290
360C	2200			50Ω	<1.6 to within 300 MHz of cut-off	N (m, f)	274 (10.8)	0.9 (2)	\$225
360D	4100			50Ω	<1.6 to within 300 MHz of cut-off	N (m, f)	187 (7.4)	0.45 (1)	\$225

362 Series Waveguide Low Pass Filter Specifications

Model	Passband (GHz)	Stopband (GHz)	Passband Insertion Loss	Stopband Rejection	SWR Maximum	Waveguide Size	Equivalent Flange	Length mm (in)	Shipping Weight kg (lb)	Price
X362A	8.2-12.4	16-37.5	<1 dB	At least 40dB	1.5	WR 90	UG-39/U	136 (5.4)	0.9 (2)	\$900
M362A	10.0-15.5	19-47			1.5	WR 75	Cover	114 (4.5)	0.9 (2)	\$825
P362A	12.4-18.0	23-54			1.5	WR 62	UG-419/U	94 (3.7)	0.37 (13 oz)	\$915
K362A ¹	18.0-26.5	31-80			1.5	WR 42	UG-595/U	64 (2.5)	0.15 (5.3 oz)	\$750
R362A ¹	26.5-40.0	47-120	<2 dB	>35 dB	1.8	WR 28	UG-599/U	42 (1.7)	0.11 (4 oz)	\$690
¹ Circular Flange Adapters available: For K-Band, specify 11515A (UG-425/U). For R-Band, specify 11516A (UG-381/U).										\$150

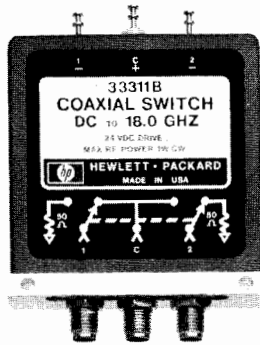

33311B

33311B/C Coaxial Switches

The 33311B and 33311C are high isolation, single-pole, double-throw coaxial switches with excellent characteristics. They are designed for use in 50 ohm systems and the un gated port is automatically terminated internally with 50 ohms, thus eliminating the need for three-switch trees. This feature makes them particularly useful in systems which require low SWR on their lines at all times. The switches are controlled by latching solenoids and switching current is automatically cut off when switching is completed. The 33311C utilizes the APC-3.5 connector which is SMA compatible and extends the operating frequency range to 26.5 GHz.

8761A/B Coaxial Switches

The 8761 is a single-pole, double-throw coaxial switch with low standing-wave ratio, low insertion loss, and excellent isolation from dc to 18 GHz. Mechanically, the switch is a break-before-make type controlled by a latching solenoid. Any of seven coaxial connectors, or a 50-ohm termination, may be specified for each port.

HP-IB Compatible

The 33311B/C and the 8761A/B switches can be remotely controlled by HP-IB with either the 11713A or the 59306A. The 11713A Attenuator Switch Driver is referenced on page 460. The 59306A HP-IB Relay Actuator is referenced on page 28.

33311B/C Specifications

Frequency Range

33311B: dc to 18 GHz.

33311C: dc to 26.5 GHz.

SWR (50 ohm characteristic impedance)

33311B: <1.25, dc to 12.4 GHz; 1.5, 12.4 to 18 GHz.

33311C: <1.3, dc to 10 GHz; <1.5, 10 to 16 GHz; <2.3, 16 to 26.5 GHz.

Insertion Loss

33311B: <0.25 dB, dc to 2 GHz; <0.5 dB, 2 to 18 GHz.

33311C: <0.25 dB, dc to 2 GHz; <0.5 dB, 2 to 10 GHz; <0.8 dB, 10 to 16 GHz; <1.4 dB, 16 to 26.5 GHz.

Isolation

33311B: >90 dB, dc to 18 GHz.

33311C: >90 dB to 12.4 GHz; >85 dB, 12.4 to 18 GHz; >50 dB, 18 to 26.5 GHz.

RF Connectors

33311B: (3) SMA female.

33311C: (3) APC-3.5 female (SMA compatible).

Power: 1 W average, 100 W peak (10 μ sec duration).

Solenoid voltage (dc or pulsed): 24 volts. Diode protected to reduce voltage transients.

Switching speed: <30 ms (including settling time).

Life: >1,000,000 switchings.

Size: 54 H x 53 W x 14 mm D (2.13 x 2.13 x 0.56 in.) excluding connectors and solenoid terminals.

Weight: net, 88 gm (0.2 lb); shipping, 220 gm (0.5 lb).

Options: 011, 5-volt solenoid voltage (only on 33311B).

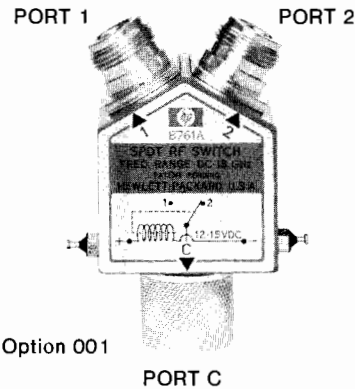

8761A Option 001

8761A/B Specifications

Characteristic impedance: 50 ohms.

Frequency range: dc to 18 GHz.

Standing-wave ratio

Frequency	SWR		
	7-mm	N	SMA
dc-12.4 GHz	1.15 (1.20)	1.20 (1.25)	1.30 (1.30)
dc-18 GHz	1.20 (1.25)	1.25 (1.30)	1.35 (1.35)

SWR in parentheses applies to switch with built-in termination

Insertion loss: <0.5 dB, dc to 12.4 GHz; <0.8 dB, dc to 18 GHz.

Isolation: >50 dB, dc to 12.4 GHz; >45 dB, dc to 18 GHz.

Power: 10 W average, 5 kW peak; built-in termination rated at 2 W average, 100 W peak.

Switching energy: 1.5 W for 20 ms (permanent magnet latching).

Solenoid voltages (dc or pulsed): 12 to 15 V, 8761A; 24 to 30 V, 8761B.

Switching speed: 35 to 50 ms (including settling time).

Life: >1,000,000 switchings.

Size: 41 H x 38 W x 38 mm D (1.6 x 1.5 x 1.5 in.) excluding connectors and solenoid terminals.

Weight: net, 140 to 220 gm (0.3 to 0.5 lb); shipping, 220 to 300 gm (0.5 to 0.7 lb).

How to Order 8761A/B Switches

Specify solenoid voltage and connectors (including built-in 50-ohm termination) by the alphabetic suffix on the switch model number and the appropriate three-digit option number.

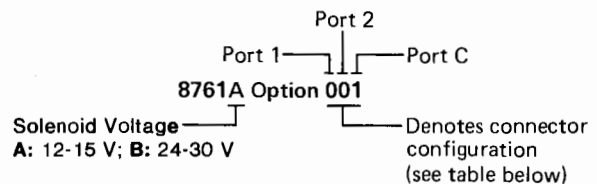

Option Code	Connector Type	Option Code	Connector Type
0	N (f)	4	APC-7 for UT-250 Coax
1	N (m)	5	SMA (f)
2	APC-7 w/Threaded sleeve	6	SMA (m)
3	APC-7 w/Coupling nut	7	50 Ω Termination

Ordering Information

8761A/B order must include option number

8761A/B Coaxial Switch (quantity 1-9)

8761A/B Coaxial Switch (quantity 10-24)

8761A/B Coaxial Switch with 50-ohm termination

33311B Coaxial Switch (quantity 1-9)

33311B Coaxial Switch (quantity 10-24)

33311C Coaxial Switch (quantity 1-9)

33311C Coaxial Switch (quantity 10-24)

Price

Each \$250

Each \$240

add \$35

Each \$500

Each \$470

Each \$650

Each \$610

MICROWAVE TEST EQUIPMENT

Adapters, Waveguide Stands, Air Lines

Models 281A/B/C, 292A/B

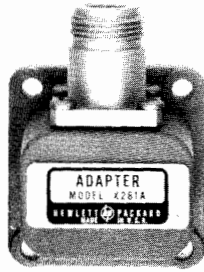

X281A

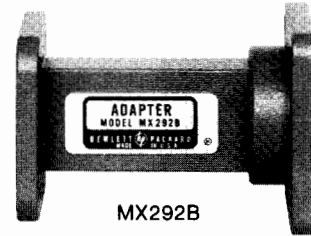

MX292B



X281C



P281C



K281C

281A/B Coax to Waveguide Adapters

HP 281A,B adapters transform waveguide transmission line into 50-ohm coaxial line. Power can be transmitted in either direction, and each adapter covers the full frequency range of its waveguide band with SWR less than 1.25.

281C Coax to Waveguide Adapters

The 281C family adds high precision measurement capability to HP's waveguide to coax adapter line. Low SWR permits excellent matching of waveguide systems to coaxial instruments. The stepped-taper internal structure acts as an impedance transformer and compensating filter. This significantly reduces mismatch uncertainty which makes more accurate measurements possible.

292A/B Waveguide Adapters

Models 292A,B waveguide-to-waveguide adapters connect two different waveguide sizes with overlapping frequency ranges. The 292A consists of a short tapered section of waveguide. The 292B is broached waveguide with a step transition between waveguide sizes.

281A/B/C Specifications

HP Model	SWR	Frequency Range (GHz)	Waveguide Size EIA	Coaxial Connector	W/G Flange UG-() U	Price
S281A	1.25	2.60-3.95	WR284	N Female	584	\$150
G281A	1.25	3.95-5.85	WR187	N Female	407	\$150
J281A	1.25	5.30-8.20	WR137	N Female	441	\$125
H281A	1.25	7.05-10.0	WR112	N Female	138	\$110
X281A	1.25	8.20-12.4	WR90	N Female	135	\$95
X281B	1.25	8.20-12.4	WR90	APC-7	135	\$225
Option 013				N Female		less \$15
P281B	1.25	12.4-18.0	WR62	APC-7	419	\$180
Option 013				N Female		less \$15
X281C	1.05	8.20-12.4	WR90	APC-7	135	\$265
Option 012				N Male		less \$15
Option 013				N Female		less \$15
P281C	1.06	12.4-18.0	WR62	APC-7	419	\$265
Option 012				N Male		less \$15
Option 013				N Female		less \$15
K281C	1.07	18.0-26.5	WR42	APC-3.5 (f)	597	\$315
Option 012				APC-3.5 (M)		N/C

*2.3 from 5.3 to 5.5 GHz.

292A/B Specifications

HP Model	Frequency Range (GHz)	SWR	W/G Size Flange	to	W/G Size Flange	Price
HX292B	8.2-10.0	1.05	WR 112 UG-51/U		WR 90 UG-39/U	\$150
MX292B	10.0-12.4	1.05	WR 75 Cover		WR 90 UG-39/U	\$190
MP292B	12.4-15.0	1.05	WR 75 Cover		WR 62 UG-419/U	\$150
NP292A	15.0-18.0	1.05	WR 51 Cover		WR 62 UG-419/U	\$150
NK292A	18.0-22.0	1.05	WR 51 Cover		WR 42 UG-595/U	\$150

MICROWAVE TEST EQUIPMENT



Adapters, Waveguide Stands, Air Lines

Models 11515/6/A, 11524/5/A, 11533/4/A, 11540 series, 11566/7/A, 11588A, 11606A

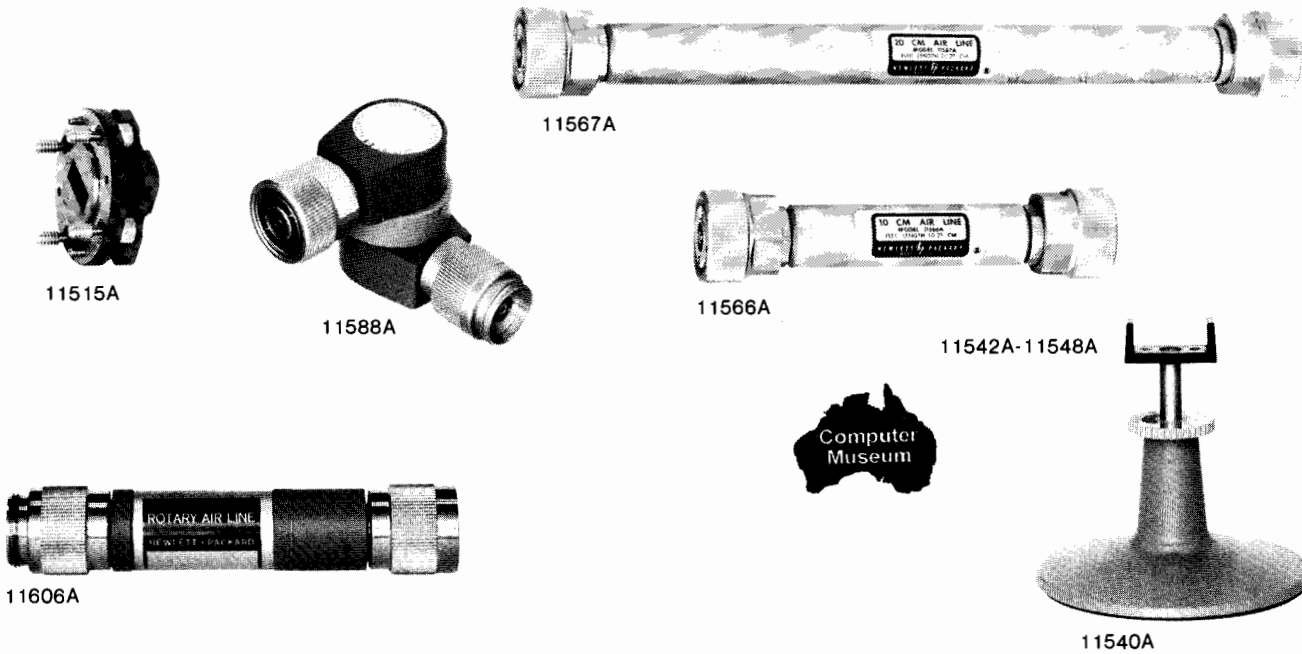

11515A, 11516A Waveguide Adapters

The 11515A is a square to circular flange adapter for K-band (UG-425 to UG-595). The 11516A is a square to circular flange adapter for R-band (UG-381 to UG-599).

11524A, 11525A, 11533A, 11534A Coax to Coax Adapters

These coaxial adapters permit easy interconnection of 50-ohm precision 7-mm (APC-7) connectors and 50-ohm Type N or SMA (3-mm type) connectors. See illustrations page 713.

11588A Swivel Adapter, 11606A Rotary Air Line

The 11606A rotary air line and the 11588A swivel adapter are capable of a full 360° of rotation. A combination of the air line and the adapter permits rigid coax movement in three dimensions. Even the most awkwardly shaped devices can be easily connected or disconnected in a coax system with the aid of these components. Insertion loss is <0.5dB and uncertainty due to rotation is -57dB.

11515A, 11516A Specifications

HP Model	Frequency Range (GHz)	SWR	W/G Size Flange	to	W/G Size Flange	Price
11515A	18.0-26.5	—	WR 42 UG-425/U		WR 42 UG-595/U	\$150
11516A	26.5-40.0	—	WR 28 UG-381/U		WR 28 UG-599/U	\$150

11524A, 11525A, 11533A, 11534A Specifications

HP Model	Description	Shipping Weight	Price
11524A	APC-7 to N female	110 g (4 oz)	\$125
11525A	APC-7 to N male	140 g (5 oz)	\$125
11533A	APC-7 to SMA male	140 g (5 oz)	\$175
11534A	APC-7 to SMA female	140 g (5 oz)	\$175

11566A, 11567A Air Line Extension

Impedance: 50 ohms.
Frequency: dc-18 GHz.
Reflection coefficient: 0.018 + 0.001 (frequency in GHz).
Connector: APC-7
Length: 11566A, 102.5 mm (4 in.); 11567A, 202.5 mm (8 in.).
Shipping Weight: 0.45 kg (1 lb).

11540 Series Waveguide Stand, Waveguide Holders

The 11540A waveguide stand locks HP waveguide holders at any height from 70 to 133 mm (2.75 in. to 5.25 in.). The stand is 64 mm (2.25 in.) high, and the base measures 121 mm (4.75 in.) in diameter. The waveguide holders are offered in seven sizes to hold waveguide covering frequencies from 3.95 to 40 GHz.

11588A, 11606A Specifications

HP Model	Frequency Range GHz	SWR	Connectors	Dimensions mm (in)	Shipping Weight kg (lb)	Price
11588A	DC-12.4	1.1	APC-7(m)(f)	42 x 59 x 30 (1 1/8 x 2 3/16 x 1 3/16)	0.28 (10 oz.)	\$425
11606A	DC-12.4	1.1	APC-7(f)	100 x 19 (4 x 3/4)	0.45 (1 lb)	\$350

Ordering Information

11566A Air line extension	\$215
11567A Air line extension	\$250
11540A Waveguide stand	\$40
11542A G-Band Waveguide holder	\$35
11543A J-Band Waveguide holder	\$25
11544A H-Band Waveguide holder	\$25
11545A X-Band Waveguide holder	\$25
11546A P-Band Waveguide holder	\$25
11547A K-Band Waveguide holder	\$25
11548A R-Band Waveguide holder	\$25

MICROWAVE TEST EQUIPMENT

Frequency Response Test Sets, 10 MHz to 26.5 GHz

Model 8755 System

- 10 MHz to 26.5 GHz frequency range
- Absolute & ratio measurement capability
- Complete complement of measurement accessories
- 0.1 dB resolution and offset

- 60 dB dynamic measuring range for each detector
- Excellent stability with time and temperature
- Free of interference from stray fields or unwanted signals

8750A Storage-Normalizer

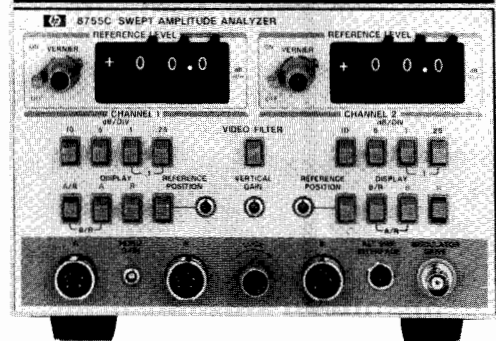
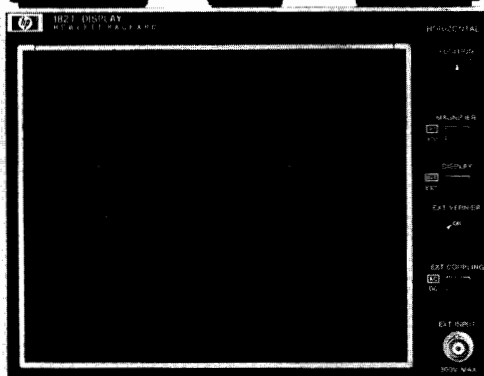
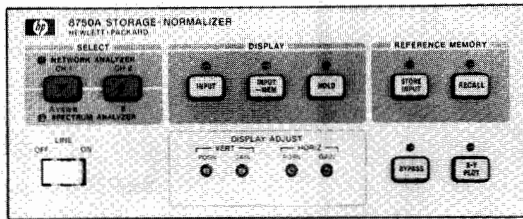

182T Display/8755C Plug-in
11664A Detectors

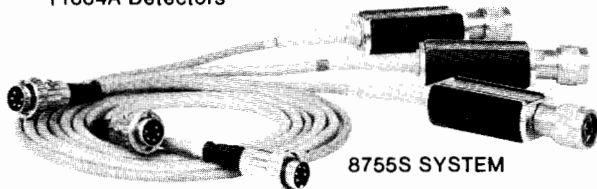

8755S SYSTEM

8755S Frequency Response Test System

The 8755S is an economy network measurement system designed to make absolute power and ratio measurements over the 10 MHz to 26.5 GHz frequency range. It is a versatile system capable of fulfilling the majority of scalar (amplitude only) impedance and transmission measurement requirements. The 8755S system consists of the following separate instruments: (1) 8755C Swept Amplitude Analyzer, (1) 182T display unit, (1) 8750A Storage Normalizer, and (3) 11664A Schottky diode detectors.

The 8755C has two independent channels and three detector inputs allowing simultaneous ratio measurement capability. All three detectors have a +10 dBm to -50 dBm dynamic range, are interchangeable, and require no calibration. For each channel a resolution of 10, 5, 1, 0.25 or 0.1 dB per division is available (also combinations of these, e.g., 15 dB/division) as well as a calibrated offset of ± 59.9 dB in 0.1 dB increments. The 8750A Storage-Normalizer connects directly to the 8755/182T by a single cable to provide digital normalization and storage capability for both channels.

Common measurements made with the 8755 are simultaneous insertion and return loss, amplifier gain and gain compression, and mixer conversion loss and return loss, all on a swept frequency basis. The 8755S system has many features that improve both the accuracy and the versatility compared with other scalar measurement systems.

The 8755S system can interface with sources having alternate sweep capability, such as the 8350A Sweep Oscillator, allowing two independent frequency and power ranges to be displayed on consecutive sweeps. With this powerful capability, measurements of amplifier compression and filter pass/stop band response become simple manual measurements. For added flexibility in this mode, the 8755C allows full channel independence of scale per division and offset.

The 8755C uses an ac detection system which can reject undesired RF signals such as local oscillator feedthrough in mixer measurements, external traffic in antenna measurements, and broadband noise in amplifier measurements. The 8755C provides the 27.8 kHz squarewave drive to AM modulate the RF sweeper output either directly (most HP 8620 and all 8350 RF sweeper plug-ins are directly compatible with the 8755) or by using the 11665B External Modulator.

In addition to making absolute or relative power measurements with a single detector, the 8755 will also measure the logarithmic difference in power between two detectors, i.e., ratio measurements. Ratio measurement techniques improve accuracy by providing better equivalent source match and immunity to source power variations. A ratio technique can also allow dynamic range expansion up to 100 dB.

The 8750A Storage-Normalizer improves both the accuracy and convenience of swept frequency measurements. System frequency response error is eliminated by subtracting a digitally stored calibration trace from the measurement trace using the 8750 input minus memory mode. The input minus memory mode also facilitates comparison measurements by providing a single trace display of the difference between two devices. The 8750A has digital storage for flicker-free displays so that a complete trace is seen independently of the RF sweep rate. This is a real benefit when device constraints require a slow sweep rate as when making narrow band filter measurements. The 8750A also makes x-y plotting much more convenient by automatically outputting the x, y and penlift signals from digital memory at the push of a single button.

A number of accessories are available for use with the 8755S system to meet most signal separation and filtering requirements. These include the HP 11666A Reflectometer Bridge, the HP 11667A Power Splitter, and the HP 11678 Filter Kits. The HP 11679A and B Extension Cables are also available for use with the 11664 Detectors or the 11666A Bridge to make remote measurements without performance degradation.

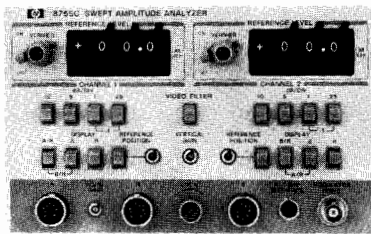

8755C

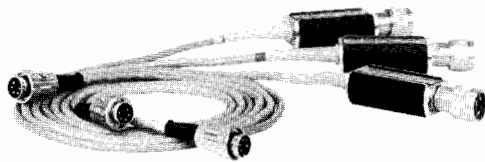

11664A

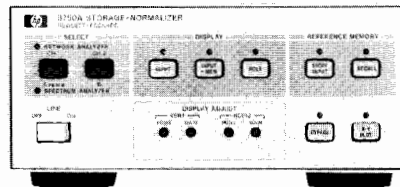

8750A

Individual Instrument Specifications

8755C Plug-in

Function: The 8755C plug-in processes demodulated 27.8 kHz signals from the 11664 Detectors (R,A,B) for logarithmic display on 180 series oscilloscopes.

Resolution: Independent for each channel in steps of 10, 5, 1, 0.25, or 0.1 dB per division.

Offset: Independent for each channel. ± 59.9 dB in 0.1dB increments.

Display Units

180 "T" series displays are recommended for use with the 8755C. They provide zero offset recorder outputs, and both positive and negative 5-volt retrace blanking inputs.

Large screen (Model 182T): This display unit is contained in the 8755S standard configuration. It has an 8 x 10 division internal graticule with 1 div = 1.29 cm. and medium persistence P39 phosphor.

Rack mount (Model 180TR). This display unit is contained in the 8755S Option 001 system configuration. It has an 8 x 10 division internal graticule with 1 div = 1 cm. and medium persistence P39 phosphor.

The 182T and 180TR are directly compatible with the 8750A Storage-Normalizer. As a result of the 8750A compatibility, the 182T and 180TR cannot be used with time domain plug-ins.

Variable persistence/storage (Model 181T, Cabinet Model 181TR, Rack Mount): These displays can be ordered individually for use with the 8755C. Because they offer CRT storage, they have not been made compatible with the 8750A Storage-Normalizer. They have an 8 x 10 division internal graticule with 1 div = 0.95 cm. and offer variable persistence phosphor for storing single or multiple traces.

11664A Detectors

Function: Designed specifically for use with the 8755C Swept Amplitude Analyzer, the 11664A detects the envelope of the 27.8 kHz modulated microwave signal. It uses a biased Schottky diode to achieve -50 dBm sensitivity.

Frequency range: 10 MHz to 26.5 GHz.

Tracking between two 11664A Detectors:

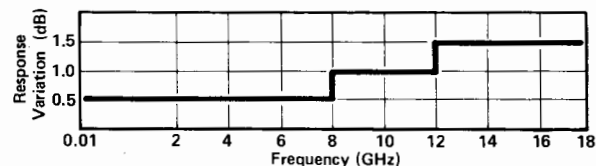

Typical frequency response:

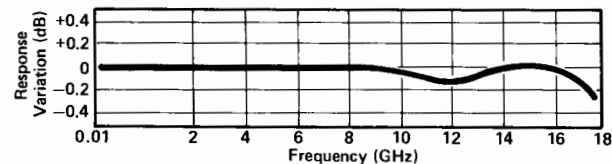

Return loss:

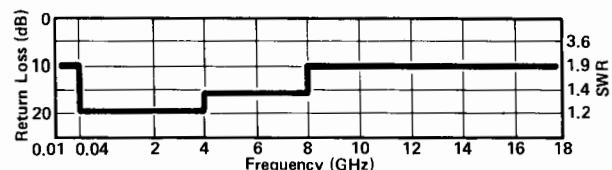

Impedance: 50 ohms nominal

Connector: N-Male.

11664B Detectors

(All specifications are the same as the 11664A with the following differences):

Frequency range: 10 MHz to 26.5 GHz.

Tracking between two 11664B Detectors: Tracking between two detectors at the same power level is typically <2 dB from 10 MHz to 26.5 GHz.

Return Loss:

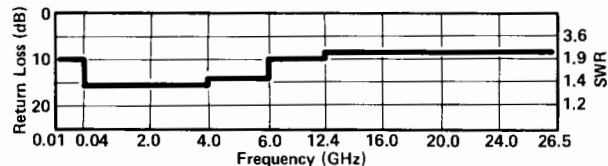

Connector: APC 3.5 Male.

11664C Detector Adapter

Function: Allows the 8755 to be used with many available diode detectors. Two adjustments allow the detector to be mated with the 8755 to provide absolute power as well as ratio with a frequency range that is determined by the diode detector used.

Connector: BNC male

8750A Storage-Normalizer

Function: Provides digital storage display and digital normalization for both channels of the 8755. The 8750A connects directly to the 8755/182T via a single cable.

Ordering Information

The 8755S system and its options are configured of separate instruments and components solely for ordering convenience. If a different display or optional connectors are desired, each part of the system should be listed separately.

	Price
8755S Complete Test Set	\$7940
Opt 001: Rack mount version	\$25
Opt 002: deletes (2) 11664 Detectors, adds 11666A Reflectometer Bridge	add \$1980
Opt 003: adds 11665B Modulator	add \$890
Opt 004: deletes 8750A Storage-Normalizer	less \$1890
Opt 005: Replaces (3) 11664A with (3) 11664B	add \$720
8755C Test Set Plug-in only	\$2275
11665B 15 MHz 18 GHz Modulator	\$890
11664A 10 MHz 18 GHz Detector	\$385
Opt 001: APC-7 Connector	add \$25
11664B APC 3.5 10 MHz to 26.5 GHz Detector	\$625
11664C Detector Adapter	\$225
182T Large Screen Cabinet Scope Display	\$2615
180TR Standard Screen Rack Display	\$2760
181T Storage, Cabinet Display	\$3565
181TR Storage, Rack Display	\$3840
11666A Reflectometer Bridge	\$2750
11679A 7.6 m (25 ft) Detector Extension Cable	\$75
11679B 61 m (200 ft) Detector Extension Cable	\$350
11668A 50 MHz High Pass Filter	\$500
11667A DC to 18 GHz Power Splitter	\$850
11678A Low Pass Filter Kit	\$1100
Individual filters: specify model number	\$220

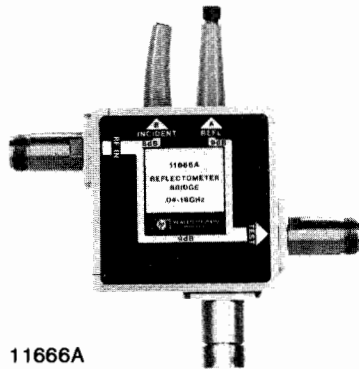

11666A

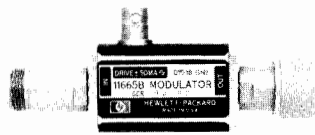

11665B

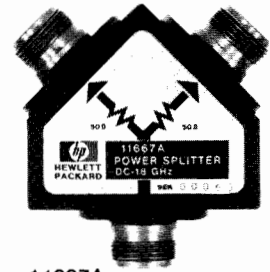

11667A

11666A Reflectometer Bridge

Reflection measurements covering from 40 MHz to 18 GHz with one directional device can be made with the Model 11666A Reflectometer Bridge. Operation of this type of directional device is based on principles of the resistive Wheatstone Bridge extended to microwave frequencies. When three bridge arms are 50Ω, the voltage across corners of the bridge is directly proportional to the reflection coefficient of the device connected in the fourth arm. Equivalent directivity is then a measure of how well the bridge circuit is balanced with a 50Ω termination connected. (Ideally this would create a voltage null representing infinite return loss.) The high equivalent directivity achievable over wide bandwidths makes the bridge configuration attractive.

The 11666A is completely dedicated to the 8755; two Schottky diode detectors (which sample the incident and reflected signals for ratioing by the 8755) are incorporated as an integral part of the bridge unit. The effective external leveling achieved by ratioing thus isolates the measurement port from source/bridge input mismatch. With the addition of an external 11664A Detector, two simultaneous ratio measurements of insertion and return loss can be made. Small size combined with its wide frequency range and high directivity make the 11666A ideal for production use.

Specifications 11666A (connected to the 8755C Analyzer)

Frequency Range: 40 MHz to 18 GHz.

Frequency Range	Equivalent Directivity	Equivalent Output SWR
40 to 100 MHz	30 dB	1.25
0.1 to 1 GHz	38 dB	1.25
1 to 2 GHz	36 dB	1.25
2 to 4 GHz	33 dB	1.25
4 to 8 GHz	29 dB	1.25
8 to 12 GHz	27 dB	1.27
12 to 18 GHz	26 dB	1.52

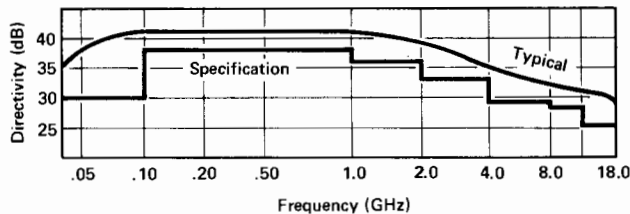

Frequency tracking

(between incident and reflected arms): <3.2dB
(between incident and test port, including 1.1 dB from 11664A Detector): <4.3dB

Nominal coupling: 6-dB incident arm. 9-dB reflected arm. 9-dB transmission loss.

Input SWR: 1.8.

Maximum input power: +15 dBm.

Connectors: Type N-Female on input and output. APC-7 Optional.
Size: 69.9 mm H x 69.9 mm W x 46.4 mm D (2³/₄" x 2³/₄" x 1⁷/₃₂"). Cable length, 1219 mm (48").

Weight: net, 0.7 kg (1.5 lb). Shipping, 2.26 kg (5.13 lb).

Accessories furnished: 11512A Short, Type N-Male (11565A short, APC-7 with Opt 002).

11667A Power Splitter

The 11667A Power Splitter is recommended when making wide-band transmission measurements using the 8755 Test Set. This two-resistor type splitter provides excellent output SWR at the auxiliary arm when used for source leveling or ratio measurement applications. The 0.25 dB tracking between output arms over a frequency range from dc to 18 GHz allows wideband measurements to be made with a minimum of uncertainty.

Frequency range: dc to 18 GHz.

Impedance: 50Ω.

	dc-4 GHz	dc-8 GHz	dc-18 GHz
Input SWR:	≤1.15	≤1.25	≤1.45
Equivalent output SWR:	1.10	1.20	1.33
leveling or ratio			
Output tracking: (between output arms)	<0.15 dB	<0.20 dB	<0.25 dB

Insertion loss: 6 dB nominal (input to either output).

Maximum input power: +27 dBm (0.5 watt).

Connectors: Type N female on all ports.

Size: 46 H x 50 W x 19 mm D (1¹³/₁₆" x 2" x 3/₄").

Weight: net, 0.06 kg (2 oz). Shipping 0.22 kg (8 oz).

Other Signal Separation Devices

Many other signal separation devices are available from HP for use with the 8755. Coaxial couplers from 0.1 to 18 GHz are available with the 770 series, the 790 series, and the 11692. Higher directivity 752 series waveguide couplers can also be used with the 8755S with the addition of appropriate 281 series waveguide to coax adaptors.

11665B Modulator

Function: absorptive on-off modulator designed for and powered by the 8755B plug-in.

Frequency Range	Return Loss On and Off	Insertion Loss	
		On	Off
15-40 MHz	≥10 dB	≤7.0 dB	≥35 dB
40 MHz-4 GHz	≥15 dB	≤3.2 dB	≥35 dB
4-8 GHz	≥12 dB	≤3.8 dB	≥40 dB
8-12.4 GHz	≥8 dB	≤4.3 dB	≥45 dB
12.4-18 GHz	≥8 dB	≤5.0 dB	≥45 dB

Modulator drive feedthrough: ≤8 mV (peak) at 27.8 kHz at either port when powered by the 8755B. Reduced to ≤1mV (peak) using the 11668A. (See 11668A High Pass Filter).

Drive current: nominally +50 mA in ON condition, -50 mA Off condition.

Weight: net, 0.17 kg (6 oz). Shipping, 0.9 kg (2 lb).

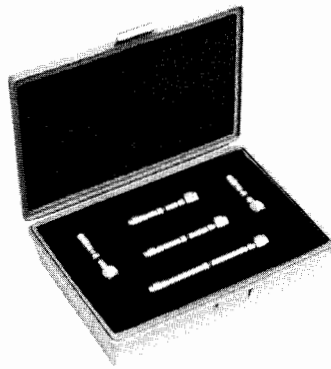

11678A



11668A

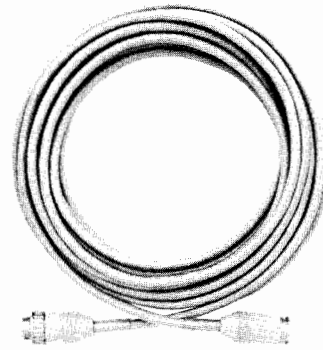

11679A

11678A Low Pass Filter Kit

The 11678A Low Pass Filter Kit contains five filters conveniently matched to HP 8620 sweeper bands. These filters have <1.1 dB insertion loss at 0.95 fc with > 40 dB rejection at 1.25 fc. Filter use is recommended to reduce undesirable harmonics causing errors in broadband detector measurements.

Frequency range: low pass filters, cutoff frequency fc: 11688A, 2.8 GHz; 11689A, 4.4 GHz; 11684A, 6.8 GHz; 11685A, 9.5 GHz; 11686A, 13.0 GHz.

Connectors: N-Male, N-Female.

Weight: net 0.44 kg (1 lb). Shipping 1.2 kg (2.9 lb).

11668A High Pass Filter

The 11668A High Pass Filter accessory is recommended when making measurements on active devices which have gain below 50 MHz. Use of the 11668A, placed after the 11665B, reduces the modulator drive feedthrough from 8 mV to 1 mV and prevents possible amplifier saturation. Use of the 11668A filter is not necessary for passive measurements since the feedthrough from the 11665B is -65 dBm and causes no degradation in system performance.

Frequency range: 50 MHz to 18 GHz.

	Insertion Loss	Return Loss
50–100 MHz	≤ 2.5 dB	≥ 12 dB
100 MHz–8 GHz	≤ 1.0 dB	≥ 16 dB
8–12 GHz	≤ 1.0 dB	≥ 14 dB
12–18 GHz	≤ 1.5 dB	≥ 14 dB

Maximum input: +27 dBm.

Connectors: N-female, N-male

Weight: 0.13 kg (5 oz). Shipping 0.28 kg (10 oz).

11679A/B Extension Cables

11679A 25-foot Extension Cable and 11679B 200-foot Extension Cable fit directly between 11664A Detector and display. Remote detector operation is permitted without performance degradation.

Common System Specifications

Power Measurement Range:

Single channel: +10 dBm to -50 dBm (noise level).

System accuracy (Ratio Measurements):

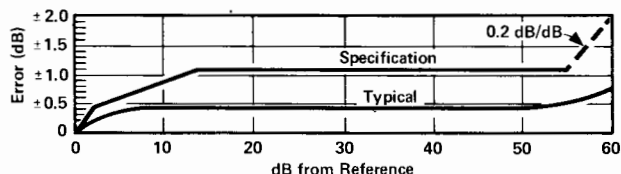

Accuracy curve shows system uncertainty for a relative measurement with +10 dBm incident at the test detector when the 0-dB reference is set. Accuracy when calibration levels below +10 dBm are used remains the same, except the additional 0.2 dB/dB uncertainty should be added for measurements below -45 dBm. This curve includes system noise, offset uncertainty, and crosstalk, and assumes the reference detector power remains fixed between calibration and test. Refer to detector, coupler, or bridge specifications to determine system frequency response.

Absolute Measurements:

Absolute power incident on a detector is displayed with respect to the 0 dBm POSITION line when the OFFSET CAL switch is turned OFF. Accuracy at any power level is typically ± 0.5 dB not including detector frequency response or mismatch errors. For applications requiring more precision, increased accuracy can be obtained if the 8755 display is calibrated at a specific power level using a power meter. The stability of the 8755 then permits accurate power measurements repeatable to hundredths of dBs.

General

Resolution: Independent for each channel in steps of 10, 5, 1, or 0.25 dB per division. Combinations of steps can be engaged, e.g. 10 dB/div. and 5 dB/div. to achieve 15 dB/div.

Offset: Independent for each channel. ± 59 dB in 1 dB increments.

Graticule: 8755S, 1 Div. ≈ 1.29 cm. 8755S Option 001, 1 Div. ≈ 1 cm.

Temperature range: Operation, 0 to 55°C; storage, -40 °C to 75°C.

Power: 48 to 440 Hz, 115/230 V $\pm 10\%$, typically 100 watts.

8755S Specifications

Consists of:

- 8755C Swept Amplitude Analyzer
- 182T Display
- 11664A Detectors (3 each)
- 8750A Storage-Normalizer

Frequency range: 10 MHz to 18 GHz (determined by the 11664A Detectors)

8755S Option 001 Specifications

Consists of:

- 8755C Swept Amplitude Analyzer
- 180TR Display
- 11664A Detectors (3 each)
- 8750A Storage-Normalizer

8755S Option 002 Specifications

Consists of:

- 8755C Swept Amplitude Analyzer
- 182T Display
- 11664A Detector (1 each)
- 11666A Reflectometer Bridge
- 8750A Storage-Normalizer

Frequency range: 40 MHz to 18 GHz (determined by the 11666A Bridge).

8755S Option 003 Specifications

Adds 11665B External Modulator.

Frequency range: 15 MHz to 18 GHz (determined by the 11665B Modulator).

8755S Option 004 Specifications

Deletes the 8750A Storage-Normalizer.

8755S Option 005 Specifications

Consists of:

- 8755C Swept Amplitude Analyzer
- 182T Display
- 11664B Detectors (3 each)
- 8750A Storage-Normalizer

Frequency range: 10 MHz to 26.5 GHz (determined by the 11664B Detectors).



MICROWAVE TEST EQUIPMENT

- Measures insertion loss (or gain) or return loss
- 40 MHz to 18 GHz frequency range
- Automatically plot or display up to 500 points of data

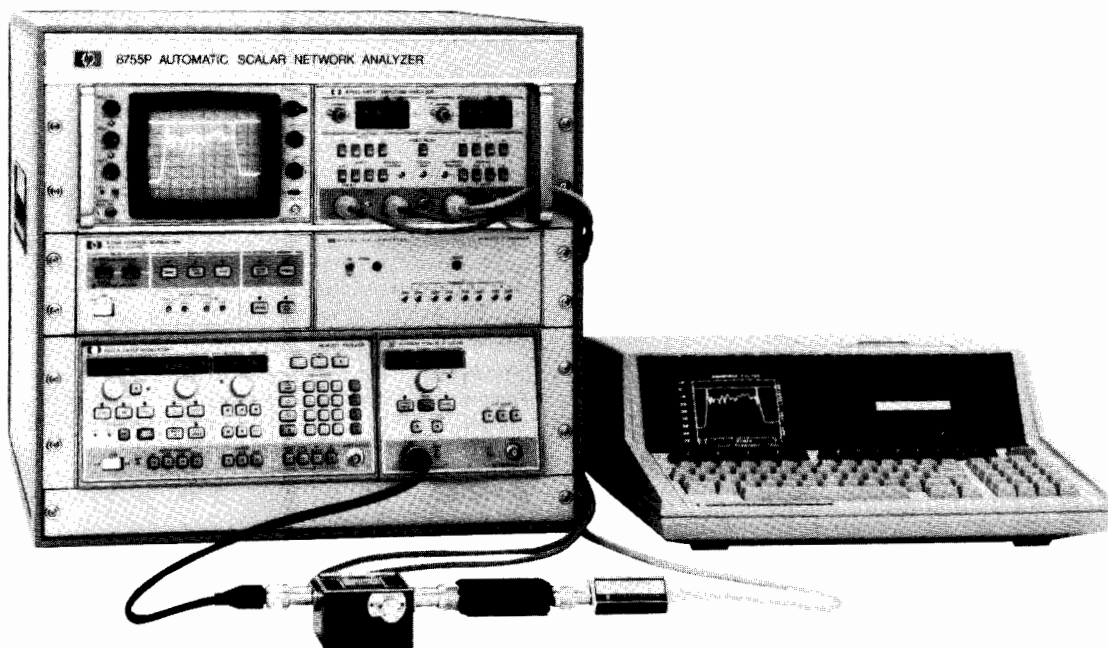

The HP 8755P is an Automatic Scalar Network Analyzer that can measure insertion loss (or gain) and return loss at microwave frequencies. Control for this automatic system is provided through the Hewlett-Packard Interface Bus (HP-IB). Included in the system are an HP 8755S Frequency Response Test Set, an HP 8350A Sweep Oscillator with an HP 83592A Plug-in (0.01 to 20 GHz), an HP 85F Computing Controller, and a Software Pac.

Easy to Use

The 8755P system is fully assembled and integrated at the factory. All accessories and cables necessary for making transmission and reflection measurements are supplied with the system, including calibration accessories such as a short circuit and a shielded open circuit.

The 8755P system comes with software that demonstrates many of the capabilities of the system. With it, you can automatically calibrate and measure up to 500 points of insertion or return loss, or up to 250 points of both. You also get your choice of output formats: print (or display) the data in a tabular style, or print (or display) a graph of the data.

The measurement program is written in a modular style so that you can easily customize it for your specific measurement needs.

Versatile

With this system, manual measurements as well as automatic measurements are fast, easy, and convenient. The 8755P comes with an HP 8750A Storage Normalizer to make manual measurements less fatiguing and more accurate. The 8750A uses digital storage to display slow-sweeping signals at a flicker-free rate, and it can store a calibration trace and subtract it from subsequent measurements.

High Performance

Each component of the 8755P is a high performance instrument in its own right. Together, they form the highest performance Automatic Scalar Network Analyzer available.

The 8755C Frequency Response Test Set has 60 dB of calibrated dynamic range (+10 to -50 dBm) in all three input channels (A, B, and R). It uses an AC modulation/detection system for improved performance when measuring signals that are in the presence of unmodulated noise. Detector adapters (HP 11664C) are available that can be used with waveguide detectors for measurements up to millimeter-wave frequencies.

Test signals are provided by the HP 8350A, the highest performance Sweep Oscillator made. While the 8350A is fully programmable via HP-IB, the sweeper is also extremely easy to use from the front panel. For example, frequencies may be entered by a knob, through the keyboard, or by increment and decrement keys. Up to nine independent front panel settings may be saved or recalled at the touch of a key, or through HP-IB, to help speed your measurements.

With the 8755C, this sweeper offers Alternate Sweep Capability: the ability to define two different frequency ranges (or power settings with 83500 series plug-ins) and alternate between them on successive sweeps. This is invaluable for making adjustments to a test device and observing the effects in two different frequency ranges at once.

Dimensions:

Cabinet: 41 H x 53 W x 56 cm D (16 x 21 x 22 in).

Controller: 16 H x 44 W x 45 cm D (6.3 x 16.5 x 17.8 in).

Weight: Net 74.9 kg (165 lbs). Shipping 118 kg (260 lbs).

Power consumption: 450W

Ordering Information

HP 8755P Automatic Scalar Network Analyzer (0.4 to 18 GHz) \$45,930

Option 001 Substitute HP 86290B Plug-in (2 to 18.6 GHz) for HP 83592A less \$7,050

Option 002 Delete Controller less \$5,020

Option 003 Delete Plug-in less \$23,500



The Hewlett-Packard Model 415E SWR Meter is a low noise, tuned amplifier-voltmeter calibrated in dB and SWR for use with square law detectors. It is an extremely useful instrument for measuring SWR, attenuation, and gain directly from metered scales, or as a tuned amplifier for driving an X-Y recorder when making RF substitution measurements. The 415E responds to a standard tuned frequency of 1000 Hz. This frequency is front panel adjustable over a range of 7% for exact matching to the internal 1 kHz modulation of the signal source being used. Amplifier bandwidth is also adjustable from 15 to 130 Hz. The narrow bandwidth allows maximum sensitivity at CW frequencies while the wider bandwidths enable swept tests to be displayed on an oscilloscope or X-Y recorder.

A precision 60 dB attenuator with an accuracy of 0.05 dB/10 dB assures high accuracy in making substitution measurements. An expand-offset feature allows any 2 dB range to be expanded to full scale for maximum resolution. Linearity is ± 0.02 dB on expanded ranges and is limited only by meter resolution on normal scales. This performance, together with the inherently low noise figure, allows maximum measurement range with exceptional resolution and linearity.

The Model 415E operates with either crystal or bolometer detectors. Both high and low-impedance inputs are available for crystal detectors. Precise bias currents of 4.5 and 8.7 mA (200 Ω) are available for operation with bolometers as selected at the front panel. This bias is peak limited for positive bolometer protection.

Both ac and dc outputs located on the rear panel allow use of the 415E as a high-gain tuned amplifier or for X-Y recorder operation. In addition, the 415E can be operated with an internally mounted battery pack (Option 001) for completely portable use.

Specifications

Sensitivity: 0.15 μ V rms for full-scale deflection at maximum bandwidth (1 μ V rms on high impedance crystal input).

Noise: at least 7.5 dB below full scale at rated sensitivity and 130 Hz bandwidth with input terminated in 100 or 500 Ω ; noise figure less than 4 dB.

Range: 70 dB in 10 and 2-dB steps.

Accuracy for low xtal impedance settings: 10 dB to 50 dB range, ± 0.05 dB/10 step; 50 dB to 60 dB range, ± 0.10 dB/10 dB step; maximum cumulative error between any two 10 dB steps is ± 0.10 dB; maximum cumulative error between any two 2 dB steps is ± 0.05 dB.

Accuracy for high xtal impedance and bolometer settings: ± 0.05 dB/10 dB step; maximum cumulative error between any two dB steps is ± 0.10 dB; maximum cumulative error between any two 2 dB steps is ± 0.05 dB.

Linearity: ± 0.02 dB on expanded scales, determined by inherent meter resolution on normal scales.

Input: unbiased low and high impedance crystal (50-200 and 2500-10,000 Ω optimum source impedance respectively for low noise); biased crystal (1 V into 1 k Ω); low and high current bolometer (4.5 and 8.7 mA $\pm 3\%$ into 200 Ω), positive bolometer protection; input connector, BNC female.

Input frequency: 1000 Hz adjustable 7%; other frequencies between 400 and 2500 Hz available on special order.

Bandwidth: variable, 15-130 Hz; typically less than 0.5 dB change in gain from minimum to maximum bandwidth.

Recorder output: 0-1 V dc into an open circuit from 1000 Ω source impedance for ungrounded recorders; output connector, BNC female.

Amplifier output: 0-0.3 V rms (Norm), 0-0.8 V rms (Expand) into at least 10,000 Ω for ungrounded equipment; output connector, dual banana jacks.

Meter scales: calibrated for square-law detectors; SWR: 1-4, 3.2-10 (Norm); 1-1.25 (Expand). dB: 0-10 (Norm); 0-2.0 (Expand); battery: charge state.

Meter movement: taut-band suspension, individually calibrated mirror-backed scales; expanded dB and SWR scales greater than 108 mm (4 $\frac{1}{4}$ " long).

RFI: conducted and radiated leakage limits are below those specified in MIL-I-6181D.

Power: 115-230 V $\pm 10\%$, 50-400 Hz, 1 W; optional rechargeable battery provides up to 36 hr continuous operation.

Weight: net 4 kg (9 lb). Shipping 5.8 kg (13 lb).

Size: 155 H, 190 W, 279 mmD (6.09" x 7.78" x 11").

Ordering Information

415E SWR Meter

Opt 001: rechargeable battery installed

Opt 002: rear panel input connector in parallel with front panel connector

Price

\$1050

add \$105

add \$25



Why Network Analysis?

Characterizing the behavior of linear networks that will be stimulated by arbitrary signals and interfaced with a variety of other networks is a fundamental problem in both synthesis and test processes. For example, the engineer designing a multi-component network must predict with some certainty the final network performances from knowledge of the individual components. Similarly, a production manager must know allowable tolerances on the products manufactured and whether the final products meet the specified tolerances. Network analysis offers a solution to these problems through complete description of linear network behavior in the frequency domain.

Network analysis accomplishes the description of both active and passive networks by creating a data model of such component parameters as impedances and transfer functions. However, these parameters not only vary as a function of frequency but are also complex variables in that they have both magnitude and phase. Until the advent of the modern network analyzer, phase was difficult to measure at CW frequencies and often involved laborious calculations; these measurements were accomplished by conventional oscilloscopes at lower frequencies and slotted lines at microwave frequencies. However, swept network analyzers now measure magnitude and phase (the total complex quantity) as a function of frequency with less difficulty than conventional CW measurements. Impedance and transfer functions can then be conveniently displayed on a swept CRT, as in Figure 1, X-Y recorder, or com-

puter controlled peripherals such as a printer and/or a plotter. HP computers also combine with network analyzers to give new levels of speed and accuracy in swept measurements that could only be attained previously by long calculations at CW frequencies.

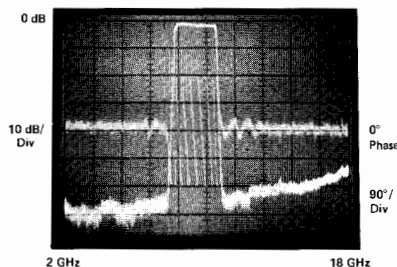

Figure 1. 2 GHz to 18 GHz measurement of magnitude and phase in a single sweep

Thus, network analysis satisfies the engineering need to characterize the behavior of linear networks quickly, accurately, and completely over broad frequency ranges. In design situations, this minimizes the time required to test new designs and components, allowing more time to be spent on the design itself. Likewise, production test times may be minimized while reducing the uncertainties surrounding the test.

What Is Network Analysis?

Network analysis is the process of creating a data model of transfer and/or impedance characteristics of a linear network through sine wave testing over the frequency range of interest. All network analyzers in the HP

product line operate according to this definition.

Creating a data model is important in that actual circuit performance often varies considerably from the performance predicted by calculations. This occurs because the perfect circuit element doesn't exist and because some of the electrical characteristics of a circuit may vary with frequency.

At frequencies above 1 MHz lumped elements actually become "circuits" consisting of the basic elements plus parasitics like stray capacitance, lead inductance, and unknown absorptive losses. Since parasitics depend on the individual device and its construction they are almost impossible to predict. Above 1 GHz component geometries are comparable to a signal wavelength, intensifying the variance in circuit behavior due to device construction. Further, lumped-element circuit theory is useless at these frequencies and distributed-element (or transmission-line) parameters are required to completely characterize a circuit.

Data models of both transfer and impedance functions must be obtained to completely describe the linear behavior of a circuit under test. At lower frequencies, h , y , and z -parameters are examples of transfer and/or impedance functions used in network description; at higher frequencies, S -parameters are used to characterize input-output impedances and transfer functions. Therefore, a network analyzer must measure some form of a circuit's transfer and impedance functions to achieve its objective of complete network characterization. Figure 2 shows an example of a swept impedance measurement.

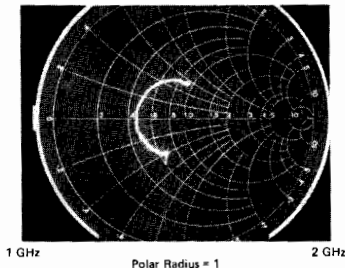

Figure 2. Input impedance of microcircuit amplifier is read directly with Smith Chart Overlay for Polar Display

Network analysis is limited to the definition of linear networks. Since linearity constrains networks stimulated by a sine wave to produce a sine wave output, sine wave testing is an ideal method for characterizing magnitude and phase response as a function of frequency. In non-linear measurements phase is often meaningless and amplitude has to be defined with respect to individual frequency components. For non-linear measurements see sections on spectrum analyzers and wave analyzers.

Network Analyzers

Hewlett-Packard Network Analyzers are instruments that measure transfer and/or impedance functions of linear networks through sine wave testing. A network analyzer system accomplishes these measurements by configuring its various components around the device under test. The first requirement of the measurement system is a sine wave signal source to stimulate the device under test. Since transfer and impedance functions are ratios of various voltages and currents, a means of separating the appropriate signals from the measurement ports of the device under test is required. Finally, the network analyzer itself must detect the separated signals, form the desired signal ratios, and display the results.

Signal Sources and Signal Separation

In the general case, any sine wave source meeting the network analyzer's specifications can be used to stimulate the device under test. For CW measurements a simple oscillator may suffice; for greater CW frequency accuracy a signal generator or synthesizer may also be desirable. If the analyzer is capable of swept measurements, great economies in time can be achieved by stimulating the device under test with a sweep oscillator or sweeping synthesizer. This allows quick and easy characterization of devices over broad frequency ranges. Some network analyzers will operate only with a companion source which both stimulates the device under test and acts as the analyzer's local oscillator.

At low frequencies it is not particularly difficult to separate the appropriate voltages and currents required for transfer and impedance function measurements. Signal separation is merely the process of establishing the proper shorts, opens, and connections at

the measurement ports of the device under test. As frequencies increase, the problem of signal separation usually involves traveling waves on transmission lines and becomes correspondingly more difficult. Hewlett-Packard manufactures test sets (often called "transducers") applicable for separating the appropriate traveling waves in a variety of high frequency measurements.

Broadband and Narrowband Detection

After the desired signals have been obtained from the test set (or transducer) they must be detected by the network analyzer; HP network analyzers can use one of two detection methods. Broadband detection accepts the full frequency spectrum of the input signal while narrowband detection involves tuned receivers which convert CW or swept RF signals to a constant IF signal. There are certain advantages to each detection scheme.

Broadband detection reduces instrument cost by eliminating the IF section required by narrowband analyzers but sacrifices noise and harmonic rejection. However, noise is not a factor in many applications, and careful measurement techniques, using filters, can eliminate harmonic signals that would otherwise preclude accurate measurements. Broadband systems are generally source independent while some narrowband systems require companion tracking sources. Finally, broadband systems can make measurements where the input and output signals are not of the same frequency, as in the measurement of the insertion loss of mixers and frequency doublers. Narrowband systems cannot make these measurements.

Narrowband detection makes a more sensitive low noise detection of the constant IF possible. This allows increased accuracy and dynamic range for frequency selective measurements (as compared to broadband systems) and high resolution through IF substitution using precision IF attenuators. Source dependent narrowband systems utilize a companion tracking source not only to stimulate the device under test, but also to produce a signal offset from the RF by a fixed frequency for tuning the analyzer's constant IF.

Signal Processing and Display

Once the RF has been detected, the network analyzer must process the detected signals and display the measured quantities. All HP network analyzers are multi-channel receivers utilizing a reference channel and at least one test channel; absolute signal levels in the channels, relative signal levels (ratios) between the channels, or relative phase difference between channels can be measured depending on the analyzer. Using these measured quantities, it is possible to either display directly as shown in Figure 2, or compute the magnitude and phase of transfer or impedance functions.

Magnitude measurements fall into two categories, relative and absolute; absolute measurements involve the exact signal level in each channel while relative measurements involve the ratios of the two signal channels.

Absolute measurements are usually expressed in voltage (dBV) or in power (dBm). The units dBV are derived by taking the log ratio of an unknown signal in volts to a one volt reference. Similarly, dBm is the log ratio of unknown signal power to a one milliwatt reference.

Relative ratio measurements are usually made in dB, which is the log ratio of an unknown signal (Test Channel) with a chosen reference signal (Reference Channel). This allows the full dynamic range of the instrumentation to be used in measuring variations of both high and low level circuit responses. For example, 0 dB implies the two signal levels have a ratio of unity while ± 20 dB implies a 10:1 voltage ratio between two signals.

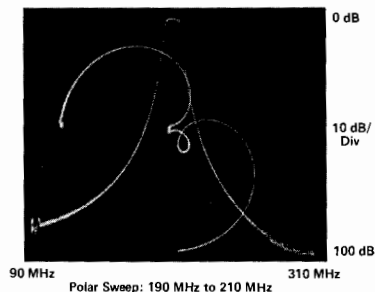

Figure 3. Simultaneous measurement of transmission response and passband reflection coefficient

All network analyzer phase measurements are relative measurements with the reference channel signal considered to have zero phase. The analyzer then measures the phase difference of the test channel with respect to the reference channel!

Measurement results at CW frequencies may be displayed on analog meters, LEDs or computer controlled printers. Swept frequency measurements of amplitude and phase may be displayed versus frequency on CRTs or X-Y plotters. Insertion Loss is displayed in two different ways in Figure 4. The addition of digital storage and normalization to network analyzer CRT's assures flicker-free traces and removal of frequency response errors for fast, real-time displays of test device responses versus frequency.

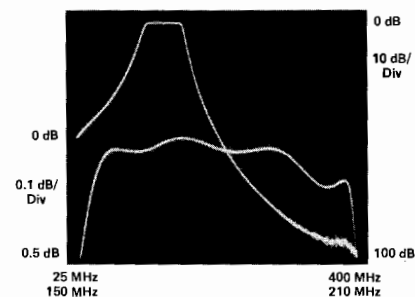

Figure 4. Simultaneous measurement of filter passband and skirts using alternate sweep

Low Frequency Network Analysis

Networks operating at frequencies below 10 MHz are generally characterized by measuring the gain and phase changes through the network and the associated input and output impedances; h, y, and z-parameters as well as other lumped-component models are typical analytical and computational tools used to represent these measurements. The first derivative of phase with respect to frequency, group delay, is an important measurement of distortion in communication systems. Hewlett-Packard produces a broad line of instrumentation capable of measuring all of these parameters.

Phase information complements amplitude data in the measurement of low frequency parameters. Phase is more sensitive to network behavior and it is a required component of complex impedance and transfer functions. For instance, phase is required to determine the frequency of network resonances (poles) and anti-resonances (zeroes). This is because the phase shift of a network transfer function is exactly zero at the frequency of resonance. Phase information is also vital in circuit design, particularly loop design, where phase margins are critical.

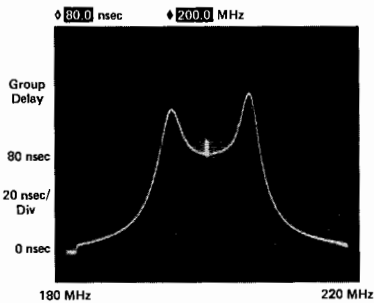

Figure 5. Direct Measurement of Group Delay with digital readout at marker

Phase data is also required to measure delay distortion or group delay of networks. Delay distortion occurs when different frequency components of a complex waveform experience nonlinear phase shifts as they are transmitted through a network. Group delay is a measure of this distortion and is defined as:

$$T_g = \frac{d\theta}{d\omega}$$

There are several techniques for measuring group delay; the most common techniques are phase slope, amplitude modulation, frequency modulation, and frequency deviation. Most HP network analyzers can make measurements with at least one of these techniques while several analyzers measure and display group delay directly. Choice of a group delay measurement technique is dependent on the particular device under test and the resolution required.

An alternative method for measuring phase distortion is deviation from linear phase or differential phase. Deviations from linear phase can be measured by introducing enough electrical length in the network analyzer's reference channel to linearize a device's phase shift. Once this has been accom-

plished it is possible to observe any variations in phase shift linearity at high resolution. Since group delay is the derivative of phase ($d\theta/d\omega$), nonlinearities in phase shift correspond directly to changes in a device's group delay. Figure 6 shows deviation from linear phase and group delay. Introduction of electrical length in the measurement channel may be accomplished by physically adding cable, or it may be accomplished electronically on some network analyzers.

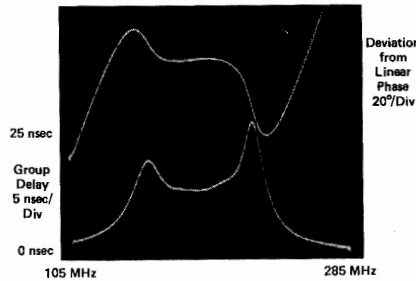

Figure 6. Two independent techniques for measuring filter phase distortion

At lower frequency (typically ≤ 50 kHz) digital signal analysis using Fast Fourier Transformations (FFT) can also be used to determine the magnitude and phase of transfer characteristics. This subject is treated in the Signal Analysis section of this catalog.

High Frequency Network Analysis

Measurements of voltages and currents become more and more difficult as frequency increases. Consequently, H, Y, and Z parameters lose their usefulness at high frequencies. High frequency network behavior can be better described using transmission line theory in terms of forward and reverse travelling waves. Thus, travelling waves make a logical replacement for voltages and currents in high frequency measurements.

Scattering parameters or S-parameters were developed to characterize linear networks at high frequencies. S-parameters define the ratios of reflected and transmitted traveling waves measured at the network ports. A two-port device is modeled with S-parameters in Figure 7. S_{11} is the complex reflection coefficient at port 1 and is the ratio of E_r/E_i , if $E_{i2} = 0$ (port 2 terminated in its characteristic impedance). S_{21} is the complex transmission coefficient from port 1 to port 2, E_{t2}/E_{i1} , if $E_{i2} = 0$. E_i and E_r represent the amplitude and phase of the incident and

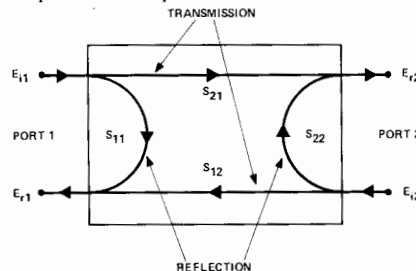

Figure 7. S-parameter model for a two-port linear network

emerging or reflected traveling waves. By reversing the ports and terminating port 1 in its characteristic impedance, S_{22} and S_{12} can be similarly defined. From these definitions, the following equations can be derived:

$$E_r1 = S_{11}E_{i1} + S_{12}E_{i2}$$

$$E_r2 = S_{21}E_{i1} + S_{22}E_{i2}$$

where incident signals act as independent variables determining the signals leaving the network. The definition of an S-parameter can be easily extended to multiport networks; measurement is also easily accomplished by terminating additional ports in their characteristic impedances. Thus, S-parameters completely describe linear network behavior in the same manner as low frequency parameters.

S-parameters offer numerous advantages to the microwave engineer because they are both easy to use and easy to measure. They are easy to measure because the device is terminated in its characteristic impedance allowing swept broadband frequency measurement without tuning, enhancing the stability of active devices, and permitting a test set up to be used for different devices. The design process is simplified because S-parameters are directly applicable to flow graph analysis. HP network analyzers and the appropriate test sets will measure and directly display S_{21} or S_{12} as gain or attenuation and S_{11} or S_{22} as reflection coefficient, return loss or impedance. Figure 8 shows measurements of both S_{21} and S_{11} . Also, S-parameters may be directly related to h, y, and z-parameters through algebraic transformations.

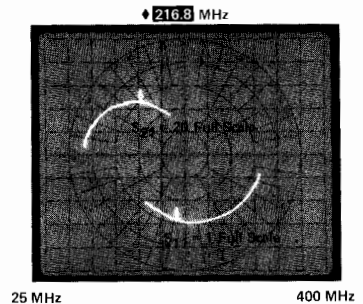

Figure 8. Simultaneous measurement of transistor S-parameters

Additional Capabilities

The computational capabilities of a digital computer can complement the network analyzer's versatility through simplifying and speeding measurements, data processing, and accuracy enhancement. Hewlett-Packard has combined network analyzers and computers into measurement systems and now offers some analyzers that may be easily interfaced with HP desktop computers through the Hewlett-Packard Interface Bus.

Precision design work and manufacturing tolerances demand highly accurate measurements, but most errors in network measurements are complex quantities that vary as a function of frequency, making manual error correction prohibitive. However, the computer can make great contributions to measurement accuracy by quickly and easily performing the complex mathematics of sophisticated error correction.



Aside from new levels of accuracy, computer controlled network analyzers can be programmed to set up and make many measurements automatically. The measurement process is further accelerated by the computer's ability to store, transform, summarize, and output data in a variety of formats to a number of peripherals. These capabilities make the computer controlled network analyzer ideal for both computer aided design or automatic production testing.

Network Analyzer Product Line

Hewlett-Packard offers a complete line of network analyzers capable of measurements through the 1 Hz to 40 GHz frequency range. Further information and detailed specifications on individual network analyzers are available on the following pages (see matrix on following page for specific page numbers).

3575A

The 3575A measures Phase and Amplitude or Gain. With the 3575A, the complete response picture is available at a reasonable cost from a single instrument, over an 80 dB range, from 1 Hz to 13 MHz. The 3575A uses a broadband measurement technique, which is attractive because the measurement is not constrained by internal tracking source or dedicated external device. The 3575A is not dependent on the wave shape, thus measurements can be made on a variety of waveforms such as triangle and square waves.

3040A/3042A

The 3040A is a network analysis system capable of measuring amplitude, phase, and group delay to 13 MHz. The system consists of a synthesizer signal source and a two-channel tracking detector. Measurement applications include filter design and production, amplifier testing, delay measurements on communication devices, and measurements on any linear two-port device.

The 3042A is a fully automatic system which uses the HP 9825T Desktop Computer as a computing controller. The memory, computational power and decision-making power of the computing controller extend the measurement solutions to complex networks in the lab or rapid production line testing. Accuracy can be improved by subtracting system errors from the measurements by using the memory and algebraic powers of the computer and supplied software.

8407A

The 8407A Network Analyzer tracks the 8601A generator/sweeper (or the 8690B/8698B sweeper) from 100 kHz to 110 MHz. Measurement capabilities include:

- 1) Transmission (gain, loss, phase shift) and reflection (return loss, impedance) measured quickly and easily in either 50Ω or 75Ω by sweeping over the frequency range of interest.
- 2) Complex impedance $[Z]$, θ , or $R \pm jX$ over the wide impedance range 0.1Ω to $>10\text{ k}\Omega$.

- 3) Voltage and current transfer functions.

- 4) High impedance in-circuit probing.

A rectangular and polar display and various CRT overlays permit direct readings of parameters of interest as frequency is swept. Applications are detailed in Application Notes 121-1 and 121-2.

8405A

The 8405A Vector Voltmeter is a dual-channel RF millivoltmeter and phasemeter. It reads the absolute voltages on either of two channels and simultaneously determines the phase relationship between them. CW measurements can be made over the frequency range 1 MHz to 1 GHz.

Besides its use as a voltmeter, applications of the 8405A include:

- 1) Transmission measurements (gain, loss, phase shift and return loss) in 50Ω systems.
- 2) Group delay and amplitude modulation index.
- 3) In-circuit probing.
- 4) S-parameters in 50Ω systems.

Application Notes 77-1, 77-3, 77-4, and 91 are available for more detail on the above measurements.

8754A

The 8754A is a completely integrated stimulus/response system for testing a wide variety of networks (like filters, amplifiers, and attenuators) in the 4 to 2600 MHz frequency range. By combining a swept source, three channel tuned receiver, and polar/rectilinear CRT display into a single compact package, outstanding performance can be achieved at an economical price. Magnitude, phase, polar reflection coefficient and impedance are all measured directly over 80 dB of spurious free dynamic range. Frequency accuracy is provided by a crystal marker system and since three receiver inputs are available, network transmission and reflection parameters can be measured simultaneously. Additionally, a complete line of 50Ω and 75Ω power splitters, transmission/reflection test sets, and S-parameter test sets, are available. High impedance probe can also be used if necessary and an external signal generator can be used directly to characterize narrow-band devices like crystal filters.

8505A/8507B/8507C

The 8505A Network Analyzer provides measurement capability from 500 kHz to 1.3 GHz. Three RF input ports, each with 100 dB of dynamic range, make possible simultaneous network measurements of reflection and transmission parameters. Two independent yet identical display channels are each capable of displaying magnitude, phase, deviation from linear phase and group delay of either the transmission or reflection characteristics of an RF network. These parameters can be displayed in rectangular, in polar coordinates or both formats at the same time. The swept source, which is an integral part of the analyzer, offers extreme frequency

flexibility through seven different modes of operation.

The 8507B and 8507C are Automatic Network Analyzers using the 8505A with HP-IB interface and HP Desktop Computers as controllers. The "Learn" mode of operation extends the traditional automatic operation to a new level of operator convenience. Accuracy enhancement, formatting of data, and the speed and ease with which data can be accumulated and summarized are all network measurement contributions made by the 8507B and 8507C.

8410B/8408A/8409C

The 8410B network analyzer system measures the transmission and reflection characteristics of linear networks in the form of gain, attenuation phase shift, reflection coefficient, normalized impedance and S-parameters in the frequency range of 110 MHz to 40 GHz.

The 8410B is a ratiometer using both reference and test signal inputs; consequently, the sweeper output must be divided into channels. This is accomplished by a "Test Set" whose other major function can be to provide the switching required for making transmission and reflection measurements with minimum or no changes in the measurement setup. Hewlett-Packard offers test sets covering various frequency ranges and switching functions.

Another major instrument required in the 8410 measurement system is a unit for the detection and display of the 1F amplitude and phase. Three plug-in displays (for the 8410B mainframe) are available for this purpose: a phase-gain indicator with meter readouts for CW measurements; a phase-gain display for displaying log amplitude and phase versus frequency; and a polar display for displaying amplitude and phase in polar coordinates.

The 8410B is capable of swept measurements over multi-octave bands through 18 GHz. Between 18 GHz and 40 GHz, 2 GHz windows may be viewed. Measurements of more than 60 dB of attenuation and 40 dB of gain are possible.

The 8409C Automatic Network Analyzer System is a practical solution to the need for automatic error-corrected RF and microwave network measurements using a simple and economical configuration. It is a complete measurement system consisting of the programmable 8350A Sweeper, the 8410B Network Analyzer System, and the 9845B Desktop Computer. It brings the major advantages in accuracy, speed, data collection, and operating convenience at a modest cost increase over the manual network analyzer system. Further information is available in Application Notes 117-1, 117-2 and 221A.

The 8408A is a low cost, programmable network measurement system based on the 8410B Network Analyzer, the 8350A Sweeper and the 85F Desktop Computer. Using automatic error correction techniques, primarily in reflection, the 8408A offers the capability of making more accurate measurements than with the 8410B manual system.

NETWORK ANALYZERS

Complete Characterization of Linear Networks (Cont.)

Network Analyzer Product Line Summary

Model	Frequency Range	Source	Measurement Capabilities
3582A Spectrum Analyzer Page 560	20 mHz to 25.599 kHz	Built-in source that is selectable as either random or pseudorandom. The noise signal is automatically band-limited and band-translated to match the analysis.	Transfer function amplitude and phase. Coherence function. Transient capture and analysis.
5420A Digital Signal Analyzer Page 568	16 mHz–25.6 kHz	Built-in random noise source.	Transfer function, coherence, power spectral density, Histogram, time record average, impulse response.
5451C Fourier Analyzer Page 570	DC to 50 kHz	Optional random pseudo-random or periodic source.	Same as 5420A
3575A Gain Phase Meter Page 486	1 Hz–13 MHz	None	Gain, Phase and Amplitude Low Frequency Analysis
3040A Manual Network Analyzer Page 483	50 Hz–13 MHz	3320B or 3330B Synthesizer	Amplitude and Phase Group Delay Gain or Loss Linear Frequency Sweep
3042A Automatic Network Analyzer Page 484	50 Hz–13 MHz	3330B Synthesizer	9825T Desktop Computer as Systems Controller Complex Network Analysis Decision Making Ability Computational Capability
8407A Network Analyzer Page 498	100 kHz–110 MHz	8601A Generator/Sweeper 8690B/8698B Sweep Oscillator	Transfer Functions, Impedance in 50 Ω , 75 Ω Systems Complex Impedance 0.1 Ω to >10 k Ω High Impedance In-Circuit Probing S-parameters in 50 Ω , 75 Ω systems
8405A Vector Voltmeter Page 500	1 MHz–1 GHz (CW)	3200B Oscillator, VHF Signal Generators, 8654 (UHF), and 8640 A/B	Voltmeter Transfer Functions, Impedance in 50 Ω systems Group Delay, Amplitude Modulation Index S-parameters in 50 Ω systems
8754A Network Analyzer Page 488	4–2600 MHz	Swept source included external source usable.	Magnitude and phase transmission coefficient reflection coefficient and return loss S-parameters, impedance.
8505A RF Network Analyzer Page 490	500 kHz–1.3 GHz	Swept Source Included	Complex Transfer functions—Gain/Loss or S-parameters Complex Impedance— Γ , Return Loss, $R \pm jX$ Distortion—Group Delay, Deviation from Linear Phase Digital Readout of Data while sweeping Frequency Counter included HP-IB with Learn Mode
8507B and 8507C Automatic Network Analyzers Page 496	500 kHz to 1300 MHz	Swept Source Included	8507B: 9825T Desktop Computer with 8505A and 8501A 8507C: 9845B Desktop Computer with 8505A and 8501A Automatic Measurements with Data Formatting and Graphics. Error Corrected Measurements
8410B Network Analyzer Page 501	110 MHz–40 GHz	8350, 8620, 8690 Series Sweep Oscillators	Transmission/Reflection Characteristics, S-Parameters 50 Ω Coax Measurements 110 MHz to 18 GHz Waveguide Measurements 8.2 GHz to 40 GHz Continuous Multioctave Measurements with 8620 and 8350 Series Sweepers DC Bias for Semiconductor Measurements
8409C Automatic Network Analyzer Page 508	110 MHz–18 GHz	8350 or 8620 Series Sweep Oscillators	Automatic Transmission/Reflection Measurements Full Error Correction in Transmission/Reflection Measurements 8410B Network Analyzer System 9826A or 9845B Desktop Computer
8408A Automatic Network Analyzer Page 508	110 MHz–18 GHz	8350 or 8620 Series Sweep Oscillators	Automatic Transmission/Reflection Measurements Full Error Correction in Reflection Measurements Tracking Error Correction in Transmission Measurements 8410B Network Analyzer System 85F Desktop Computer

NETWORK ANALYZERS

Network Analysis From 50 Hz to 13 MHz
Model 3040A

483
hp

- High resolution digital amplitude, phase and group delay measurements
- 100 dB dynamic range
- Synthesizer frequency accuracy and stability

- Precision digital sweep capability
- Narrow band analysis
- Full digital control via HP-IB

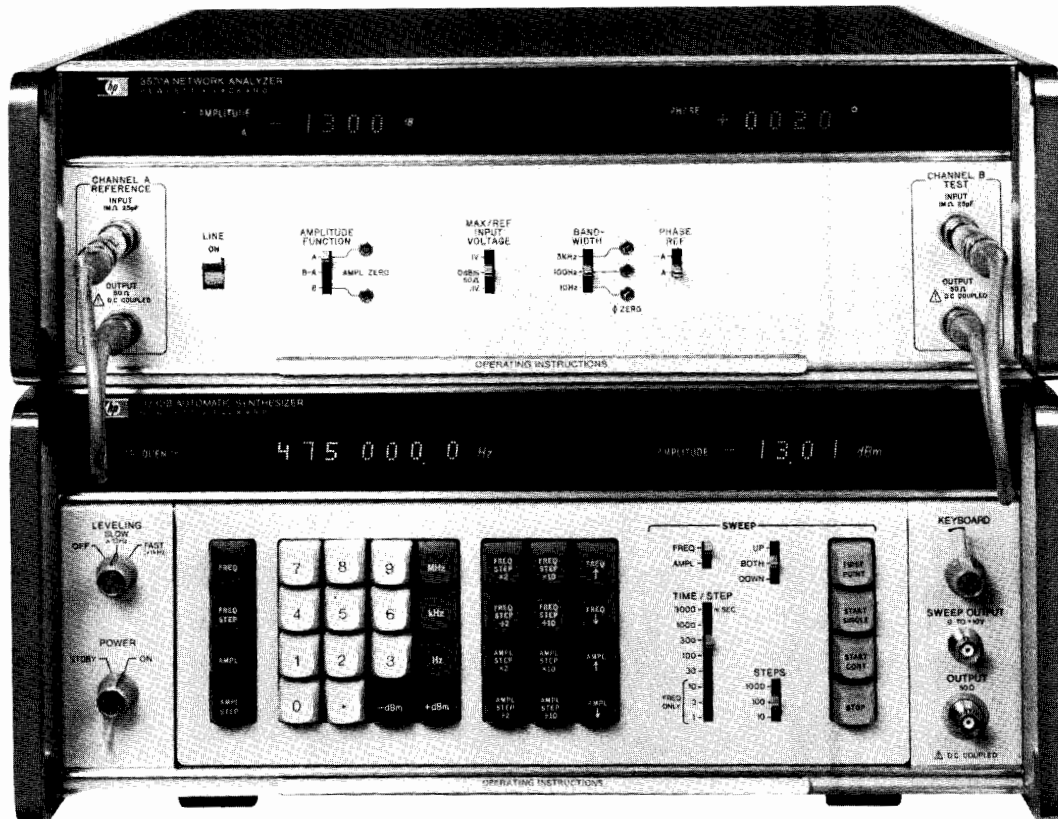

Description

The 3040A Network Analyzer is designed to meet the demand for precise and fast characterization of both active and passive linear two-port devices. The Network Analyzer is a powerful bench system that makes digital amplitude, phase and group delay response measurements over a 50 Hz to 13 MHz frequency range. It uses the 3330B Automatic Synthesizer with leveled output and digital sweep capability to generate the local oscillator signal for the 3570A Tracking Receiver and to provide the stimulus to the device under test.

This system effectively combines the wide dynamic range and the high accuracy of the 3570A Tracking Receiver with the high resolution and stability of the 3330B Synthesizer, giving design, production and Q.A. engineers working at audio, video and RF frequencies the precision, convenience, and high information content of digital swept-frequency response measurements, but with the point by point accuracy of synthesized incremental frequency sweeps.

Residual FM, often a serious limitation to the frequency resolution of swept frequency measurements, is very low ($\ll 1$ Hz) in the 3040A System, allowing accurate narrow band sweeps.

The 3570A Analyzer (Tracking Receiver) has two identical channels for fast, high accuracy "B-A" measurements of gain or insertion loss of two-port devices and to measure the phase shift between input and output ports. It can also function as a limit comparator to determine how closely the gain and phase response of a device matches that of a reference.

Both the passband and the stopband of a device can be examined in detail because the 3570A Analyzer has both a wide amplitude range of 120 dB (1 μ V to 1 V) and a high resolution display (0.01 dB increments). The digital readout also displays phase readings with 0.01° resolution.

Beyond the basic amplitude and phase measurements, the 3040A offers several automatic features not found in more conventional network analyzers.

One is Digital Offset: Values of amplitude and/or phase measured on a reference device are stored in the instrument's memory at the push of a button. Future measurements can then be displayed relative to the stored values. This could be used, for example, to quickly find the -3 dB passband limits of a filter or amplifier.

Another feature is Group Delay: As the synthesizer is stepped in frequency, the analyzer's internal digital processor calculates group delay from two phase shift measurements as $T_d = \Delta\theta/360\Delta f$ sec.

A third one is Limit Test: High and low limits can be entered as digital words from an external controller. The analyzer can be set to stop or output a marker when a limit is reached. This capability is useful, for example, to precisely find the center frequency of a resonant circuit by stopping at the 0° phase reading.

The 3040A Network Analyzer introduces precision, convenience and built-in "intelligence" to the problem of characterizing the behavior of linear networks on the bench.



NETWORK ANALYZERS

Automatic Network Analysis From 50 Hz to 13 MHz

Model 3042A

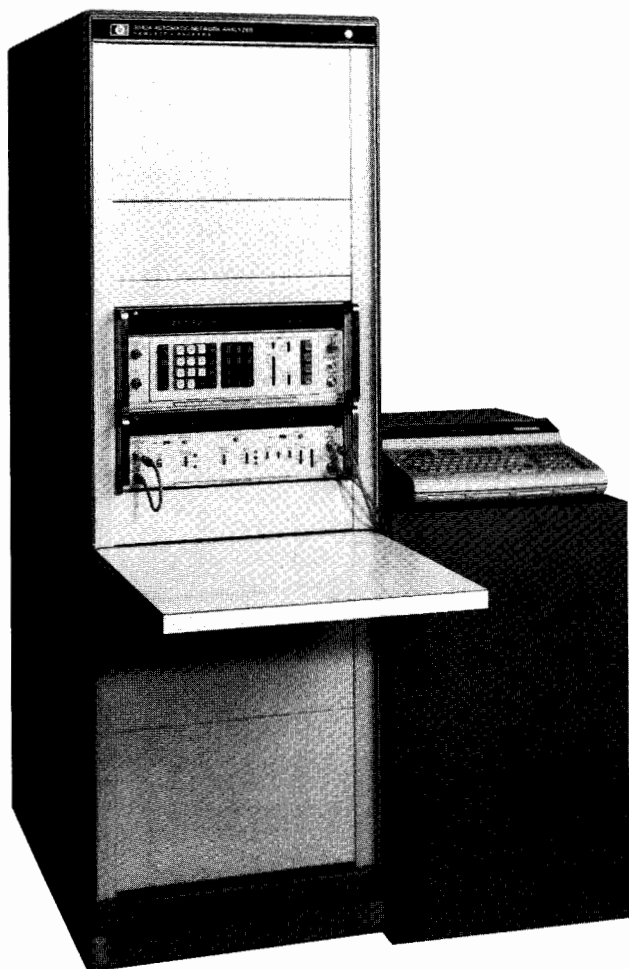

3042A Automatic Network Analyzer



Description

The 3042A is an automatic network analyzer system that greatly improves the capabilities of the 3040A Manual Network Analyzer by adding the control and computational power of the 9825T Desktop Computer. The 9825T adds speed, automation, enhanced accuracy, and simple operation to the precise amplitude, phase and group delay measurement performance of the 3040A. The versatility of the 9825T allows on-line data analysis, data reduction and decision making capability plus formatted graphic or tabular representation of results or data storage for further processing at a later time.

Environments such as production, quality assurance and the laboratory are now provided with the capability of extending precision network analysis to applications that were previously impractical because of the length of time it took to make the necessary measurements.

Production Applications

In production applications the 3042A substantially reduces the time and cost of making a range of simple or complicated tests on all types of components (e.g., crystals, amplifiers, filters and other analog devices). The system can run through a long series of tests on a device, checking performance at all specified points and deliver a simple pass/fail answer. Additionally, automatically compiled test data provides excellent statistics for improved production control, more precise scheduling and accurate production cost analysis.

- Full automation and low cost
- Speed and precision in measurements
- Accuracy enhancement of results
- Data analysis and presentation of results
- Simplicity and flexibility in operation
- HP-IB systems interfacing
- 9825T Desktop Computer

Test programs with built-in operator instructions minimize requirements for highly trained technicians, and uniform test procedures may easily be established.

Quality Assurance Applications

In quality assurance applications, the 3042A significantly reduces the cost of test equipment necessary to assure a comprehensive product testing job. In addition, the system's inherently flexible HP-IB interface structure allows the system configuration to be easily adapted by either simple software modifications or hardware additions. Skilled technicians may be relieved from repetitive yet demanding tasks and placed in positions that maximize the use of their knowledge and skills. The 3042A provides reliable and repeatable results. Various parameters may be tested in greater detail and in less time, resulting in greater product confidence and quality, and lower warranty costs. Also, automatically compiled test data provides excellent statistical data for identifying problem areas.

Laboratory Applications

In laboratory applications, engineers gain greater insight into their circuit design due to the speed and ease with which data can be accumulated and summarized with the 3042A. The easy-to-use programming format allows easy-to-write, customized programs which solve specialized measurement problems in a fraction of the time required to manually perform and evaluate the same measurements. In addition, the accuracy enhancement software furnished with the 3042A System increases accuracy of the system seven times over that of a single channel measurement (three times over a "B-A" measurement).



System Control and Interface

The 3042A Automatic Network Analyzer incorporates the 9825T Desktop Computer as system controller, operator interface and data processor. The 9825T offers the power and speed of much larger computers but features a high level programming language and editing capabilities that allow nearly instant use of the system with minimal effort. System-operator interface is greatly simplified through the 9825T's alphanumeric display and typewriter-like keyboard.

Summary

The 3042A Automatic Network Analyzer provides a complete solution to production, quality assurance and laboratory applications at audio, video and RF frequencies with accurate, reliable, repeatable and fast results plus the high information content that automatic gain-phase-delay measurements can give.

Specifications 3040A and 3042A Systems

Sources (Channel A & B outputs are isolated and electrically identical)

Frequency

Range: 0.1 to 13,000,999.9 Hz.

Resolution: 0.1 Hz (9 digits).

Amplitude

Range: +13.44 to -86.55 dBm (50Ω).

+11.68 to -88.31 dBm (75Ω option).

Resolution: 0.01 dB.

Accuracy

Leveled frequency response (10 kHz reference)*

10 Hz	13 MHz	
±0.45 dB		+13.44 dBm
±0.5 dB		-16.55 dBm
±0.6 dB		-36.55 dBm
±0.8 dB		-66.55 dBm
		-86.55 dBm

*Add 0.5 dB for leveling switch in off position.

Attenuator: (10 kHz reference, 25°C ± 5°C) ±0.02 dB/10 dB step of attenuation down from maximum output.

Absolute: (10 kHz, maximum output, 25°C ± 5°C) ±0.45 dB.

Stability: (24 hr., 25°C ± 1°C): ±0.01 dB.

Impedance: 50 or 75Ω (optional) ±2%.

Receivers (Channel A & B inputs are electrically identical and both tuned precisely to the signal source's frequency)

Frequency

Range: 50 Hz to 13 MHz.

Resolution: 0.1 Hz.

Selectivity: 10 Hz, 100 Hz and 3 kHz bandwidths (60 dB/3 dB bandwidths, 20:1).

Amplitude: (Output is in dB relative to 1 V, 0 dBm or 0.1 V, corresponding to the position of the "Max/Ref Input Voltage" switch.)

Measurement range: 1 V rms to 1 μV rms.

Dynamic range: 0 to -100 dB (using A or B amplitude function), -100 dB to +100 dB (using B-A amplitude function).

Resolution: 0.01 dB.

Accuracy: (25°C ± 5°C): Accuracy of the 3042A is enhanced with software supplied with the system from 50 Hz to 10 MHz and over the top 20 dB of the dynamic range as shown below.

Frequency response: A or B "Amplitude Function" ±0.5 dB; B-A "Amplitude Function" ±0.1 dB; using Accuracy Enhancement Software ±0.03 dB furnished with 3042A system.

Linearity: (A or B amplitude function)

0 to -20 dB	±0.2 dB
	±0.06 dB with Accuracy Enhancement
-20 to -80 dB*	±0.5 dB
-80 to -100 dB*	±1.5 dB

*Only specified to -70 dB for 3 kHz bandwidth.

Stability (8 hr., 25°C ± 1°C after 3 hr. warmup)

		Temp. Coefficient (20°C-30°C)
100 Hz & 3 kHz BW	±0.05 dB ±0.08 dB	±0.02 dB/°C
10 kHz BW	±0.08 dB ±0.15 dB	±0.05 dB/°C
	0 dB -20 dB -80 dB	

Phase (Phase Reference is Channel A)

Range: -179.5° to +179.5° (display recycles).

Resolution: 0.01°.

Accuracy: (25°C ± 5°C).

Frequency response (Channel at 0 dB)

±0.8°	±0.2°	±1°
50 Hz	100 Hz	1 MHz
		13 MHz

Amplitude response Channel B within 6 dB of Channel A

0 dB	-20 dB	-70 dB	-80 dB
±0.4°	±0.6°	±1°	

For channels at different levels (specification determination by lowest input).

0 dB	-20 dB	-60 dB	-80 dB*
±1.3°	±1.5°	±3.5°	

*Only specified to -70 dB for frequencies from 50 Hz to 60 kHz.

Linearity: ±0.2° (Channel B within 6 dB of Channel A).

Input impedance: 1 MΩ ± 2% shunted by <30 pF.

General

Programmability: all controls, except power switches, are programmable using the HP-IB format.

Ultra-high accuracy: the 3040A/3042A systems can be coupled with an external device such as a calibrated attenuator to provide relative measurements whose amplitude accuracy is limited to the amplitude stability of the receiver and source and the accuracy of the external device.

3040A Options

The basic 3040A system options are listed below. For more information refer to the 3040A/3042A data sheet.

(Order Opt 110 or 111 and Opt 120 or 121)

110: standard 50Ω 3570A \$9250

111: standard 75Ω 3570A \$9250

(Options 110 and 111 include Delay/Limit Test/Offset and Cable Lead Kit)

120: standard 50Ω 3330B \$8900

121: standard 75Ω 3330B \$8900

3042A Options

The basic 3042A system options are listed below. For more information refer to the 3040A/3042A data sheet

200: 50Ω System

N/C

201: 75Ω System

N/C

The 3042 system is fully integrated, tested, verified and specified as a system. It is supplied with complete software and documentation.

3042A Automatic Network Analyzer

\$30,500

Consisting of: 3330B Synthesizer, 3570A Network Analyzer, 9825T with 64k Bytes of memory, ROMs, Interface and documentation, 56" Rack.



NETWORK ANALYZERS

Gain/Phase Meter

Model 3575A

- dBV, dB ratio and degrees from 1 Hz to 13 MHz

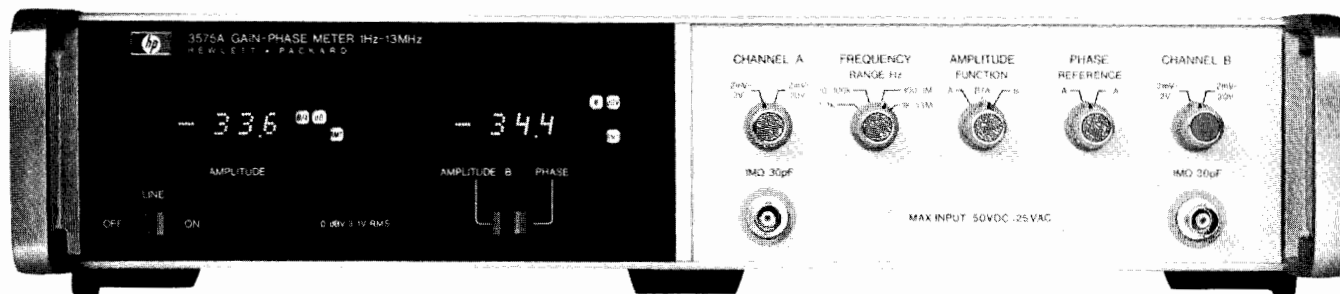

3575A Option 001 dual panel meters

Description

The HP 3575A Gain-Phase Meter is a versatile two-channel analyzer which can measure and display the absolute amplitude level or amplitude ratio of signals present at the inputs. In addition, the 3575A can measure the phase relationship of the two signals. This analyzer is a broadband detector, which is easy to use because no frequency tuning is required.

Since a dedicated tracking source is not required to operate with the 3575A, a wide selection of stimuli is possible. This flexibility coupled with a variety of possible amplitude, gain and phase outputs (LED display, analog outputs, and optional BCD) give you a wide choice of cost/results tradeoffs. For example, you may wish to manually plot your network response data on a Bode diagram in which case a low cost sine wave oscillator stimulus may be used. For easier, quicker results you may select a sweeping oscillator and an x-y plotter and let the instruments plot your response. You may use a calculator or computer to control a programmable stimulus source and the 3575A to provide automatic measurements. Here you have a wide range of computation and output possibilities.

Phase

The phase relationship of two signals is indicated over a range of ± 192 degrees with 0.1 degree resolution. A unique logic circuit (patent) design allows the 3575A to make stable phase measurements in the presence of noise. This feature minimizes the error to less than two degrees for a signal-to-noise ratio of 30 dB. One of three band limiting filters may be selected to get further noise rejection.

The 3575A is also capable of measuring the phase relationship of a variety of waveforms, such as square waves and triangle waves. Even harmonic and in-phase odd harmonic components of these signals cause no phase measurement error. For out-of-phase odd harmonic signal-to-harmonic ratios of 40 dB, measurement errors are less than 0.6 degree as shown in Figure 1.

Amplitude

The amplitude of either channel or the ratio of the two can be measured over an 80 dB dynamic range and 100 dB measurement range. Resolution is 0.1 dB. Results are displayed in dBV for channel amplitude and dB for ratio measurements. Digit blanking and channel overload annunciators will turn on if the maximum allowable signal level at either channel input is exceeded.

Readout

The standard three-digit LED display may be selected by the operator to indicate the amplitude of channel A or B, gain or phase. A second three-digit LED display is optionally available for simultaneous display of amplitude and phase readings. Lighted annunciators identify the measurement function, units and remote status.

Programmable

Two programmable options both offer full control of front panel functions and BCD output of information (amplitude, ratio or phase) contained in both digital displays. The two options give the user a choice of negative true or positive true outputs.

Applications

The 3575A can solve network analysis problems in the 1 Hz to 13 MHz frequency range where complex measurements (gain or phase or both) are required. A few of the many measurements it can make are: gain and phase response of feedback systems, envelope delay and return loss of transmission lines, complex impedance of components, and insertion loss of mixers and frequency doublers. Bode plots and Nichols charts are useful graphical tools for analyzing many of these response data.

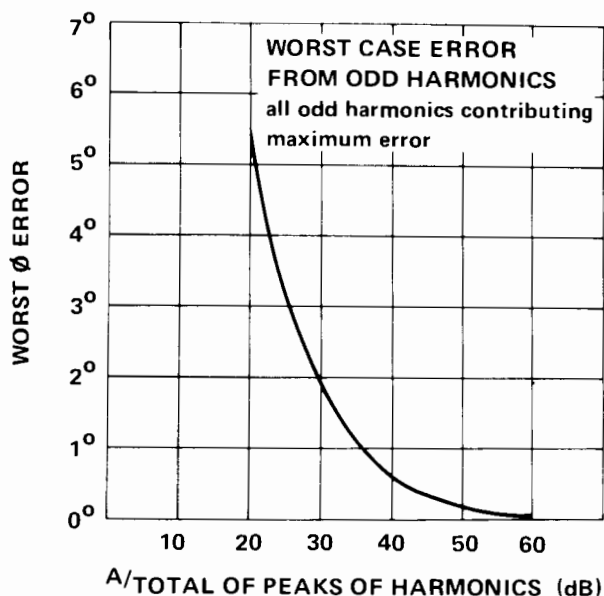
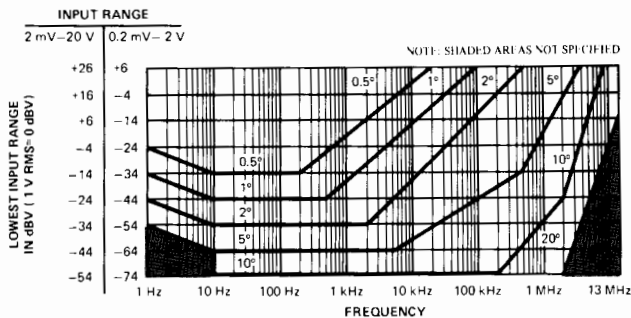

Figure 1. Worst case error from odd harmonics.

Specifications

Phase Accuracy*



*Conditions: Temperature: 25°C ± 10°C; Frequency range switch on lowest applicable range; Analog Output accuracy (rear panel).

Input signal range: 200 μV rms to 20 V rms.

Harmonic Rejection

Even harmonics: no error.

Odd harmonics: (in phase) no error.

Odd harmonics: (out of phase) 0.57° worst case error when total odd harmonic distortion is 40 dB below the fundamental.

Noise tolerance: 2° error for a 10 kHz, 1 V sine wave on one channel. One volt sine wave added to Gaussian noise (limited to a 1 MHz bandwidth and 30 dB S/N ratio) on the other channel. The 100 Hz to 1 MHz frequency range was used.

Display

Range: ± 180° with 12° of overrange.

Resolution: 0.1°.

Panel meter accuracy: ± 3 counts (0.3 degrees/dB/dBV). The panel meter error must be added to the phase and amplitude errors to obtain the display error.

Inputs

Impedance: 1 MΩ 30 pF.

Protection: ± 50 V dc, 25 V rms.

Response time to achieve 95% of final reading

Frequency Range	Time
1 Hz to 1 kHz	20 s
10 Hz to 100 kHz	2 s
100 Hz to 1 MHz	0.2 s
1 kHz to 13 MHz	20 ms

Rear terminal inputs are available as a special (3575A-C09). Digital (Opt. 002). 0, +5 V; ground true. Twelve lines to fully program all functions.

Outputs

Analog

Phase: 10 mV/degree.

Amplitude: 10 mV/dB or dBV.

Output impedance: 1 kΩ

Digital (Opt 002): 0, +5 V; ground true. 31 output lines (1-2-4-8 BCD).

Digital readout: 3½ digits with sign and annunciators. Four readings per second, fixed.

Amplitude Accuracy*

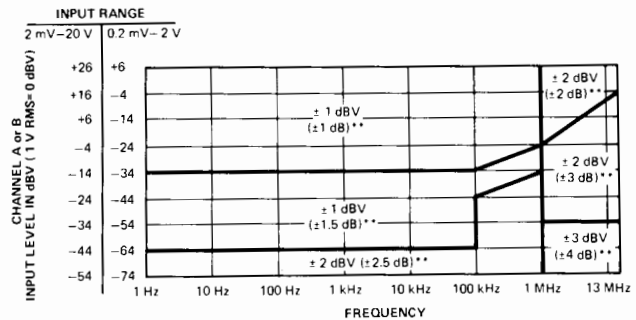

*Conditions: Temperature: 25°C ± 10°C; accuracy applies to dB V and ratio measurements with the same frequency on both channels; for ratio measurements, the lowest level channel determines accuracy; analog output accuracy (rear panel).

**Ratio (B/A) tolerances

Amplitude functions: A dBV, B dBV or B/A dB.

Amplitude reference: (A dBV, B dBV) 1 V rms = 0 dBV.

Display

Range: A dBV, B dBV: -74 dBV to +26 dBV (in two ranges). B/A dB: -100 to +100 dB. (Both input signals must be within the range of 0.2 mV rms to 20 V rms)

Resolution: 0.1 dBV, 0.1 dB.

Options

001 Dual panel meters: HP's 3575A Opt 001 is equipped with two digital readouts and two analog outputs for simultaneous amplitude and phase readings. This option has no additional measurement capability over the standard instrument.

Dual analog outputs: rear panel BNC connectors provide dc output voltages that correspond to the respective panel meter readings.

002/003 Programmable: 3575A Opt 002 and Opt 003 are equipped with dual panel meters and dual analog outputs (same as Opt 001) plus BCD outputs and complete remote control capability. Opt 002 has negative true output levels and Opt 003 has positive true output levels. BCD information from the 3575A (Opt 002) can be read by the 9800 series HP Desktop Computers with appropriate interfacing.

908: Rack Flange Kit.

General

Power: 115 V/230 V ± 10%, 48 Hz to 440 Hz, 40 VA.

Weight: net, 8.3 kg (18.4 lb). Shipping, 11.3 kg (25.8 lb).

Size: 88 H x 425 W x 337 mm D (3.47" x 16.75" x 13.25").

Accessories furnished: extender boards, line cable and 50-pin connector (Opt 002 and 003 only).

Options

001: Dual Readout	add \$600
002: Programmable (negative true output levels)	add \$1050
003: Programmable (positive true output levels)	add \$1050
908: Rack Flange Kit	add \$25
910: Extra Product Manual	add \$23

3575A Gain/Phase Meter

Price

add \$600
add \$1050
add \$1050
add \$25
add \$23

\$3850

Network Analyzers

RF Network Analyzer, 4 MHz to 1300 MHz (optional to 2600 MHz)

Model 8754A

- New H26 option covers 4 to 2600 MHz
- Integrated source, receiver, and display
- Three inputs, two measurement channels
- 80 dB dynamic range

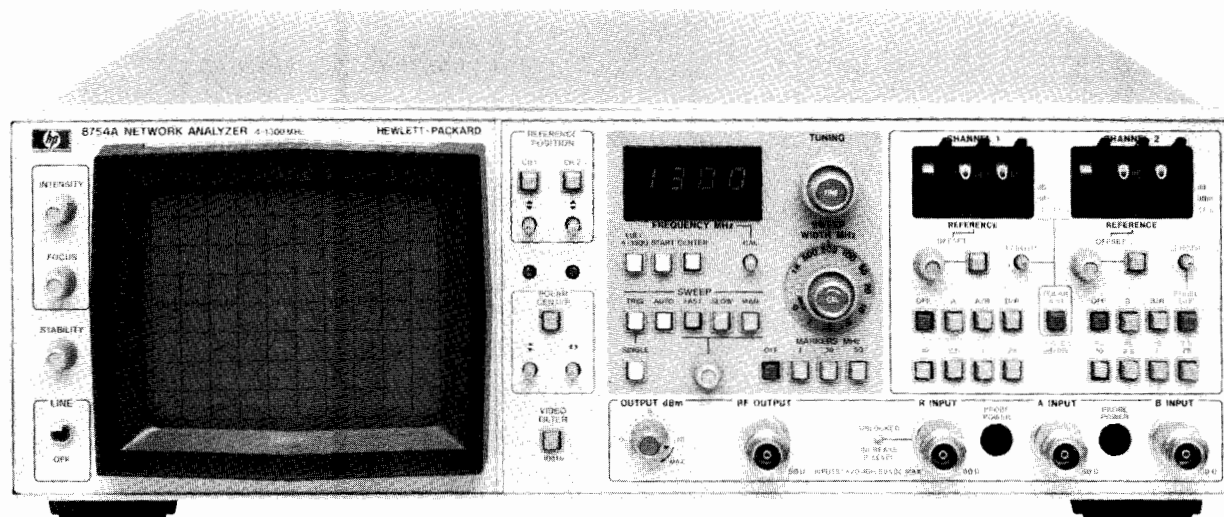

Description

The 8754A is a complete stimulus/response test system which combines a 4-1300 MHz swept source, three-input narrowband, tuned receiver, and both rectilinear and polar displays in a compact package. The convenient built-in source incorporates digital display of the start or center frequency, the ability to sweep all or any portion of the 4-1300 MHz range, and crystal markers at 1, 10, or 50 MHz intervals to enable accurate frequency calibration and measurement. The receiver provides 80 dB dynamic range in two independent measurement channels to allow simultaneous measurement of any two transmission or reflection parameters using a single test setup. Measurements of absolute power, magnitude ratio, phase angle, and reflection coefficient are displayed on the fully calibrated CRT with resolutions up to 0.25 dB and 2.5 degrees per major division. With these features the 8754A offers a new level of operating convenience and technical performance to swept magnitude and phase measurements in laboratory, production, and field testing applications at an economical price.

A comprehensive line of 50 Ω and 75 Ω test sets allow maximum versatility in a wide range of applications. Matched cable sets, precision adapters, and transistor fixtures provide convenient reliable connections to the test device. Adding the 8750A Storage-Normalizer provides flicker-free rectilinear displays regardless of sweep rate and eliminates the need for grease pencils through automatic normalization of frequency response errors. For applications that require exceptional frequency accuracy and stability, the 8754A may be used with external sources such as the HP 8660 or HP 8640 signal generators.

Now, insertion and return loss measurements to 2600 MHz can be made with the H26 options of the 8754A Network Analyzer, the 8502A Test Set, and the 11850A Power Splitter. For a complete description of these options, ask your HP Field Engineer for a data sheet (HP Publication 5952-9298).

8754A Network Analyzer Specifications

Source

Frequency range: 4 MHz to 1300 MHz (optional to 2600 MHz).

Sweep modes: Linear full sweep (4 MHz to 1300 MHz) and calibrated sweep widths with variable start or center frequency.

Sweep widths: Selectable sweep width ranges from 1 to 1000 MHz in a 1, 2, 5 sequence, plus CW. A vernier allows continuous adjustment of sweep width within each range.

Digital frequency readout: Indicates start or center frequency with 1 MHz resolution.

Markers: Internal, crystal-generated harmonic markers at 50, 10, or 1 MHz intervals ($\pm 0.01\%$ accuracy).

Output power range: 0 to typically +13 dBm; ± 0.5 dB flatness.

Spectral purity (+10 dBm RF output level):

Residual FM (swept and CW): ≤ 7 kHz RMS (10 kHz bandwidth).

Harmonics: -28 dBc.

Receiver

Frequency: 4 MHz to 1300 MHz.

Input Channels: Two test inputs (A and B) and one reference (R) input.

Impedance: 50 Ω (≤ 1.22 SWR).

Maximum input level: 0 dBm at R, A, and B inputs.

Damage level: +20 dBm (50 Vdc).

Noise level: < -80 dBm, A and B Inputs.

Minimum R input level: -40 dBm (≥ -40 dBm required to operate R input phase-lock).

Crosstalk between channels: > 83 dB.

Magnitude frequency response (flatness): Absolute (A, B): $\leq \pm 1$ dB, Ratio (A/R, B/R): $\leq \pm 0.3$ dB.

Magnitude dynamic accuracy (20 - 30°C): ± 0.3 dB from 0 to -50 dBm, ± 0.5 dB from -50 to -60 dBm, ± 1 dB from -60 to -70 dBm, ± 2.5 dB from -70 to -80 dBm.

Magnitude reference offset range: ± 199 dB in 1 dB steps ($\pm 0.1\%$). Vernier provides variable offset for calibration.

Absolute power measurements (A, B, and R): Typically ± 0.5 dBm at 0 dBm, 50 MHz input.

Phase frequency response: $\pm 2.5^\circ$.

Phase range: $\pm 180^\circ$

Phase dynamic accuracy: $\pm 2^\circ$ from 0 to -50 dBm. $\pm 4^\circ$ from -50 to -70 dBm.

Phase reference offset range: $\pm 199^\circ$ in 1° steps ($\pm 1\%$). Vernier provides variable offset for calibration.

Electrical length/Reference plane extension: Typically 0 to 16 cm length for transmission phase; typically 0 to 8 cm reference plane extension adjustment at reflection test port.

Display

Measurement functions: CRT displays either polar trace or Channel 1 and Channel 2 rectilinear traces.

Reference position: Independent reference lines for Channel 1 and Channel 2 and Polar center can be set to any position.

Video filter: Typically 100 Hz (10 kHz without filter).

Graticule size: Rectilinear, 10 cm by 8 cm; polar 8 cm in diameter.

Smith chart overlays: 2, 1, 0.2, and 0.1 full scale.

CRT photography: Tektronix C-5B Oscilloscope Camera is recommended. (UV illumination will not provide graticule exposure.)

Resolution: 10, 2.5, 1, 0.25 dB/major division. 90, 45, 10, 2.5°/major division.

Accuracy: $\pm 2\% \pm 0.05$ divisions for rectilinear trace; within 2.5 mm for polar trace.

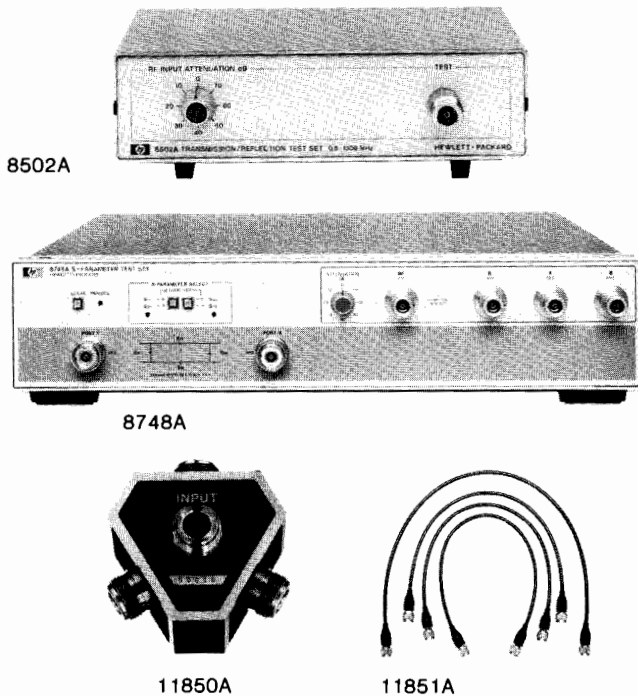

8502A

8748A

11850A

11851A

General

Sweep output: -5V to +5V.

External sweep inputs: 0 to 10 V nominal.

X-Y recorder/External CRT output:

Horizontal and vertical: 0.1V/div.

Penlift/blanking: +5V Blanking and Penlift.

External marker input: Typically -13 dBm RF signal produce a marker at the frequency of the RF signal.

Magnitude/phase output: -10 mV/Degree and -100 mV/dB.

Probe power: Two +15 Vdc and -12.6 Vdc.

Storage-normalizer interfaces: Directly compatible with the HP 8750A Storage-Normalizer. HP 8501A Storage-Normalizer requires a single internal adjustment for compatibility.

Programming connector: Outputs include magnitude/phase and sweep outputs and inputs described above as well as measurement mode selection by TTL levels or contact closures.

External source: The 8754A sweep-out voltage is provided to frequency modulate (sweep) an external signal generator for narrow-band measurement applications. A sweep input is provided to synchronize the CRT display for use with an externally swept source (8620 Series).

Temperature:

Operating: 0° to 55°C except where noted.

Storage: -40°C to +75°C.

EMI: VDE 0871/0875 and CISPR publication 11.

Safety: Conforms to the requirements of IEC 348.

Power: Selection of 100, 120, 220 and 240V +5% -10%. 48 to 66 Hz, 20 VA max.

Size: 425.5 mm wide, 133 mm high, 505 mm deep (16¼ in x 5¼ in x 19¾ in).

Weight: Net 16.8 kg (37 lb). Shipping 19 kg (42 lb).

11850A 50Ω Three-Way Power Splitter

11850B 75Ω Three-Way Power Splitter

General: One output port provides the reference output and the other two output ports can be used for independent transmission measurements. Use the 11851A RF Cable Set for interconnections. Detailed specifications on page 495.

8502A 50Ω Transmission/Reflection Test Set

8502B 75Ω Transmission/Reflection Test Set

General: Contains a power splitter and directional bridge to allow simultaneous transmission and reflection measurements. Use the 11851A RF Cable Set for interconnections. Detailed specifications on page 495.

11851A RF Cable Set

General: Three 61 cm (24") 50Ω cables, phase matched to $\pm 4^\circ$ and one 86 cm (34") 50Ω cable. Used with 8502A/B and 11850A/B. Detailed specifications on page 494.

8748A 50Ω S-parameter Test Set Specifications

Frequency range: 4 MHz to 1.3 GHz

Directivity: ≥ 40 dB.

Frequency Response:

Transmission¹ (S_{21} , S_{12}): ± 1 dB, $\pm 12^\circ$

Reflection¹ (S_{11} , S_{22}): ± 2 dB, $\pm 15^\circ$.

Port match²:

Test Port 1 and 2: ≥ 26 dB Return Loss (≤ 1.11 SWR).

Test Port 1 and 2 open/short ratio: $\leq \pm 0.75$ dB and $\pm 6^\circ$ from 4 to 1000 MHz; ≤ 0.9 dB and $\pm 7.5^\circ$ from 1000 MHz to 1300 MHz.

Insertion loss:

Input to Test Port 1 or 2: 13 dB nominal.

Input to Port A, B, or R: 19 dB nominal.

Maximum operating level: +20 dBm.

RF attenuator range: 0 to 70 dB in 10 dB steps.

Test port connectors: APC-7.

DC bias input range: ± 30 Vdc, ± 200 mA.

Includes: Cables for connection to 8754A and Reference Plane Extension Cable Kit.

Recommended accessory: 11857A Test Port Extension Cables, 11608A Transistor Fixture, or 11600B, 11602B Transistor Fixtures.

Power: 20 Vdc, supplied from 8754A via interface cable.

Size: 432 mm wide, 90 mm high, 495 mm deep (17 in. \times 3½ in \times 19½ in.).

Weight: Net, 9.1 kg (20 lb). Shipping, 11.3 kg (25 lb).

11857A APC-7 Test Port Extension Cables

General: Two precision 50Ω cables phase matched to $\pm 2^\circ$ to connect test device between 8748A test ports. Detailed specifications on page 495.

Transistor Fixtures

General: Three transistor fixtures can be used with the 8748A. The 11600B and 11602B require use of the 11858A Transistor Fixture Adapter. The 11608A transistor fixture connects directly to the 8748A. Detailed specifications on pages 504 and 506.

Adapter Kits

General: The 11853A, 11854A, 11855A, and 11856A accessory kits are available to provide precision Type N and BNC adapters and calibration standards for use with the 11850A/B, 8502A/B, and 8748A test setups. Detailed specifications on page 495.

¹ \pm degrees, specified as deviation from linear phase.

² Effective port match for ratio measurements.

Ordering Information:

	Price
8754A Network Analyzer	\$13,650
Opt H26: 4-2600 MHz	add \$1700
Opt 907: Front Handle Kit	add \$32
Opt 908: Rack Flange Kit	add \$25
Opt 909: Rack Mount Flange/Front Handle Kit	add \$55
11850A 50Ω Three-Way Power Splitter	\$675
Opt H26: 4-2600 MHz (50Ω)	add \$100
11850B 75Ω Three-Way Power Splitter	\$1125
8502A 50Ω Transmission/Reflection Test Set	\$2475
Opt H26: 4-2600 MHz (50Ω)	add \$300
8502B 75Ω Transmission/Reflection Test Set	\$2625
11851A RF Cable Set	\$800
11857A Test Port Extension Cables	\$850
8748A 50Ω S-Parameter Test Set	\$6750
Opt 907: Front Handle Kit	add \$28
Opt 908: Rack Flange Kit	add \$20
Opt 909: Rack Mount Flange/Front Handle Kit	add \$41

NETWORK ANALYZERS

RF Network Analyzer, 500 kHz to 1.3 GHz

Model 8505A

- 100 dB of dynamic range
- Digital readout of data with analog display
- Direct group delay and deviation from linear phase
- High performance sweep oscillator
- Complete family of 50Ω and 75Ω test sets
- Digital storage and normalization

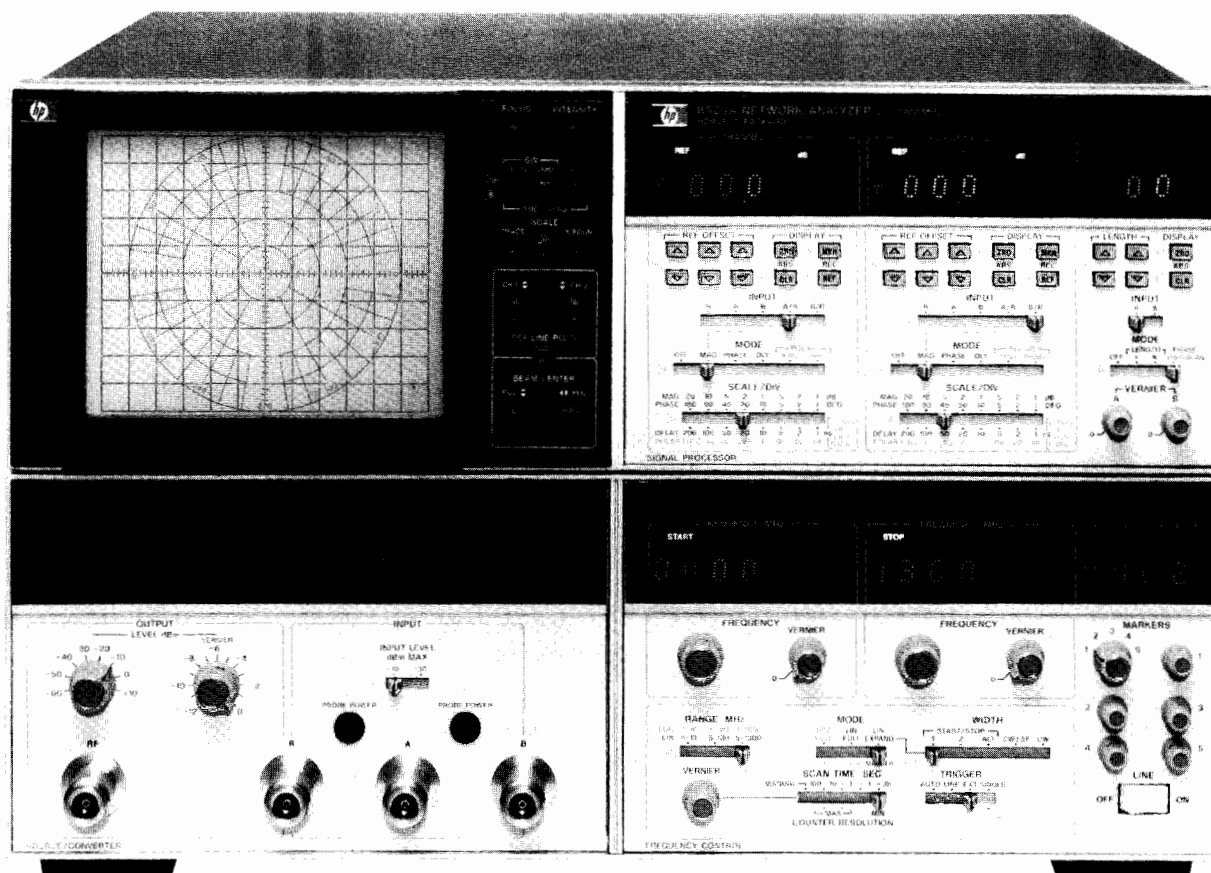

8505A



The HP 8505A is a high performance RF network analyzer operating over the 500 kHz to 1.3 GHz frequency range. It accurately and easily measures complex impedance, transfer functions and group delay of coaxial components and semiconductors. Because both magnitude and phase are measured, it is possible to completely characterize the linear behavior of either active or passive networks.

Since magnitude and phase can be measured and displayed over 100 dB of dynamic range (-10 to -110 dBm), it is a simple process for the 8505A to measure transmission loss of high rejection devices such as filters or gain and return loss of small signal devices like amplifiers. Distortion parameters like group delay, deviation from linear phase, and deviation from constant amplitude are measured in an equally straightforward manner. Group delay is measured and displayed directly to resolutions of 1 ns per major division using a new linear FM measurement technique. A unique new electrical line stretcher compensates for the linear phase shift of the device under test so that phase non-linearities may be examined at high resolution (1° per major division). Amplitude deviations with frequency can be similarly observed to resolutions 0.1 dB per major division with clear, crisp trace stability. In addition, it is possible to read out swept amplitude, phase and delay digitally at any one of five continuously variable markers with resolutions of 0.01 dB, 0.1°, and 0.1 ns respectively.

Many of the 8505A's high performance features and operating conveniences are derived from the fact that it is a completely integrated system including both the sweep oscillator and receiver. The basic instrument also includes a built-in frequency counter, polar and rectangular displays on the same CRT, the new electronic line stretcher, group delay measurement, and frequency selective digital readings of swept amplitude, phase and delay. The frequency counter with resolutions up to 100 Hz adds further precision to the measurements by allowing frequency as well as amplitude, phase and delay to be read out at any of the five markers. The 8505A is fully programmable in a straightforward fashion using the Hewlett-Packard Interface Bus (HP-IB operation is standard). The user can configure a customized automatic system or for convenience HP offers two fully configured systems, the 8507B and 8507C. (See pages 496, 497.)

Companion instruments include the 11850A Three Way Power Splitter for high resolution transmission comparison measurements, the 8502A Transmission/Reflection Bridge for simultaneous transmission and reflection measurements, and the 8503A S-parameter Test Set for complete characterization of two port devices in a single test set-up. The 8501A Storage-Normalizer adds digital storage, normalization, signal averaging, increased resolution, and graphics to 8505A measurements.

8505A Specifications

Source

Frequency Characteristics

Frequency range: 500 kHz to 1.3 GHz in three ranges; 500 kHz to 13 MHz, 500 kHz to 130 MHz and 500 kHz to 1.3 GHz.

Swept frequency accuracy: $\pm 1\%$ of range for linear sweep.

CW frequency accuracy: ± 2 counts \pm time-base accuracy.

Frequency stability: better than $\pm 0.01\%$ of reading $\pm 0.01\%$ of frequency range over 10 minutes after warm-up.

Frequency counter characteristics: frequency counter measurements are made at any one of five continuously variable marker positions without interrupting the swept RF signal.

Resolution (least significant digit)

Frequency Range (MHz)	0.5 to 13	0.5 to 130	0.5 to 1300
10 ms Sweep time	10 kHz	100 kHz	1 MHz
100 ms Sweep time	1 kHz	10 kHz	100 kHz
>1 second Sweep time	100 Hz	1 kHz	10 kHz

Counter accuracy: ± 2 counts \pm time-base accuracy.

Marker frequency accuracy: $\pm 0.002\%$ of scan width \pm counter accuracy. Measured in CW $\pm \Delta F$

Time-base accuracy: ± 5 ppm ± 1 ppm/ $^{\circ}\text{C}$ ± 3 ppm/90 days

Output Characteristics

Output power range: +10 dBm to -72 dBm.

Attenuator accuracy: ± 1.5 dBm over 70 dB range.

Vernier accuracy: ± 1 dB.

Leveling: ± 0.5 dB from 500 kHz to 1.3 GHz.

Impedance: 50 Ω ; ≥ 16 dB return loss at -10 dBm output level (<1.38 SWR).

Residual FM

Frequency Range (MHz)	0.5 to 13	0.5 to 130	0.5 to 1300
Residual FM	50 Hz rms	200 Hz rms	2 kHz rms
Bandwidth	20 Hz-1 kHz	20 Hz-1 kHz	20 Hz-10 kHz

Harmonics: >25 dB below main signal at +10 dBm output level.

Sub-harmonics and spurious signals: below -50 dBm at +10 dBm output level.

General Characteristics

Sweep modes: Linear Full, Log Full, Start/Stop 1, Start/Stop 2, Alternate, CW $\pm \Delta F$, and CW.

Sweep times: 10 ms to 100 s in decade ranges.

Trigger modes: auto, line sync., single scan or external sync.

RF Output connector: Type N female

Receiver

Frequency range: 500 kHz to 1.3 GHz

Input Characteristics

Input channels: three channels (R, A, and B) with 100 dB dynamic range.

Damage level: +20 dBm or ≥ 50 V dc.

Noise (10 kHz BW): -110 dBm from 10 to 1300 MHz; -100 dBm from 2 to 10 MHz; -95 dBm from 0.5 to 2 MHz.

Impedance: 50 Ω ; ≥ 20 dB return loss (<1.22 SWR). Typically >26 dB return loss (<1.11 SWR).

Magnitude Characteristics

Absolute frequency response (A, B, R): ± 1.5 dB

Ratio frequency response (A/R, B/R): ± 0.3 dB from 0.5 MHz to 1.3 GHz.

Dynamic accuracy: ± 0.01 dB/dB from -20 to -40 dBm; ± 0.2 dB from -10 to -50 dBm; ± 0.5 dB from -50 to -70 dBm; ± 1.0 dB from -70 to -90 dBm; ± 2.0 dB from -90 to -100 dBm; ± 4.0 dB from -100 to -110 dBm.

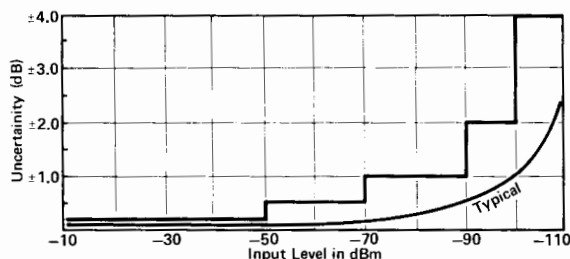

Crosstalk error limits: >100 dB isolation between inputs.

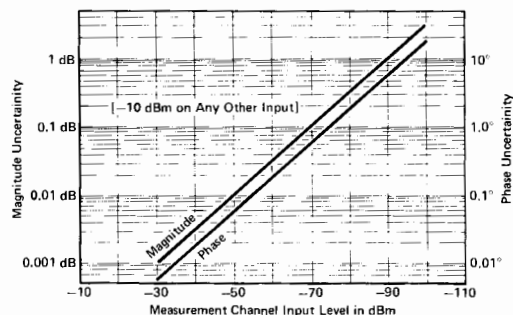

Reference offset range: ± 199.9 dB

Reference offset accuracy: ± 0.03 dB ± 0.003 dB/dB of offset

Marker measurement resolution: 0.01 dB over any <10 dB range; 0.1 dB over any ≥ 10 dB range.

CRT Display resolution: 0.1 dB to 20 dB/division in 1, 2, 5 sequence.

Phase Characteristics

Frequency response: $\pm 3^{\circ}$ from 500 kHz to 750 MHz; $\pm 5^{\circ}$ from 750 MHz to 1.3 GHz.

Range: $\pm 180^{\circ}$.

Accuracy: $\pm 0.01^{\circ}/\text{degree}$ for $\pm 170^{\circ}$; $\pm 0.01^{\circ}/\text{degree} \pm 0.5^{\circ}$ for $\pm 180^{\circ}$.

Dynamic accuracy (in 10 kHz Bandwidth): $\pm 0.02^{\circ}/\text{dB}$ from -20 to -40 dBm; $\pm 0.5^{\circ}$ from -10 to -50 dBm; $\pm 1^{\circ}$ from -50 to -70 dBm; $\pm 3^{\circ}$ from -70 to -90 dBm.

Crosstalk: see amplitude crosstalk specification.

Reference offset accuracy: $\pm 0.3^{\circ} \pm 0.5\%$ of offset.

Marker measurement resolution: $\pm 0.1^{\circ}$ over <100 $^{\circ}$ range and 1° for $\geq 100^{\circ}$ range.

CRT display resolution: 1° to 180° per division in 8 steps.

Polar characteristics: Frequency Response, Dynamic Response, Reference Offset and Marker Measurement specifications are the same as magnitude and phase characteristics.

CRT display accuracy: actual value is within less than 3 mm circle of the displayed value.

Tracking between dB offset controls and polar full switch positions: ≤ 0.2 dB.

Full scale magnitude range: 1 to 0.01 in a 1, 0.5, 0.2 sequence.

Delay characteristics

Frequency response: ± 1 ns from 500 kHz to 1.3 GHz.

Delay accuracy: $\pm 3\%$ of reading ± 3 units (Units = 1 ns for 0.5 to 1300 MHz range, 10 ns for 0.5 to 130 MHz range, and 100 ns for 0.5 to 13 MHz range.).

¹ ± 3 units may be calibrated out with thru connection.



NETWORK ANALYZERS

RF Network Analyzer, 500 kHz to 1.3 GHz (cont.)

Model 8505A

Range Resolution and Aperture

Frequency Range (MHz)	0.5 to 13	0.5 to 130	0.5 to 1300
Range	0 to 80 μ s	0 to 8 μ s	0 to 800 ns
Resolution CRT: Marker:	100 ns 100 ns	10 ns 10 ns	1 ns 1 ns
Marker with Delay scale/Div Switch set to:	10 ns ($<1 \mu$ s)	1 ns (≤ 100 ns)	0.1 ns (≤ 10 ns)
Aperture ¹	7 kHz	20 kHz	200 kHz

Reference offset range: ± 1999 dB

Reference offset accuracy: ± 0.3 units $\pm 0.3\%$ of offset.

Electrical length/ref. plane extension characteristics

Calibrated electrical length range and resolution:²

Frequency Range (MHz)	0.5 to 13	0.5 to 130	0.5 to 1300
Range X1	± 19.9 m	± 1.99 m	± 19.9 cm
X10	± 100 m	± 10 m	± 1 m
Resolution X1	10 cm	1 cm	0.1 cm
X10	1 m	10 cm	1 cm

Calibrated electrical length accuracy: $\pm 3\%$ of reading $\pm 1\%$ of range.

Linear phase substitution (degrees/scan) Range: $\pm 1700^\circ$ per scan with 0° offset.

$$\frac{\pm 1.4 \text{ km}}{\text{scan width (MHz)}} \quad \text{or} \quad \frac{\pm 4.7 \mu\text{s}}{\text{scan width (MHz)}}$$

Linear phase substitution resolution: 10°

Linear phase substitution accuracy: $\pm 3\%$ of reading $\pm 10^\circ$ / scan

Phase compensation linearity: $<0.2\%$ of phase slope inserted.

General Characteristics

RF input connectors: type N Female

Display bandwidth: selectable IF bandwidths of 10 kHz and 1 kHz. A video filter position is also provided.

CRT overlays: Smith Charts (2, 1, 0.5, 0.2, 0.1 full scale), Log Charts (10 MHz, 100 MHz and 1000 MHz).

CRT photography: HP 197A Opt 006 camera or HP 197A with 10375A Bezel Adapter required to fit 8505A display. A CRT illumination control is provided.

Auxiliary Outputs

Channel 1 and 2 outputs: 0.25 V/display division.

Sweep output: 0.25 V/display division.

Pen lift: DC coupled, 200 mA current sink.

Programming

The 8505A has a remote programming interface using the Hewlett-Packard Interface Bus with Learn Mode. Included are one 2 m (HP 10631B) and one 0.5 m (HP 10631D) HP-IB cables.

Power: selection of 100, 120, 200 or 240 V $+5\%$ -10% . 50 to 60 Hz approximately 275 watts.

Size: 279 H x 426 W x 553 mm D (11 x 16.75 x 21.75 in.).

8505A Opt 005 Specifications (Phase-Lock Operation)

Source

Frequency Characteristics

Modes (8505A): CW and CW $\pm \Delta F$ only.

Range and Resolution (8505A and 8660C/86602B/86632B): the total frequency range is 1 to 1300 MHz with a CW resolution of 1 Hz (set on the 8660C). The maximum $\pm \Delta F$ and $\pm \Delta F$ resolution is 1.3 kHz and 1 Hz from 0.5 to 13 MHz, 13 kHz and 10 Hz from 0.5 to 130 MHz, and 130 kHz and 100 Hz from 0.5 to 1300 MHz respectively.

Range and resolution (8505A and 8640B Opt 002): (Total Frequency Range: 0.5 to 1024 MHz).

	8640 Frequency Ranges (MHz)	8505A Frequency Range (MHz)		
		0.5-13	0.5-130	0.5-1300
CW Resolution (Set on 8640B)	0.5-1 1-13 16-128 128-1024	0.1 Hz 1 Hz	10 Hz	10 Hz 100 Hz
$\pm \Delta F$ Resolution (Set on 8505A)	All freq. Ranges	1 Hz	10 Hz	100 Hz
Max $\pm \Delta F$	0.5-8 8-16 16-1024	1.3 kHz 1.3 kHz	13 kHz 13 kHz	130 kHz

Typical system residual FM: the Residual FM of a phase-locked 8505A approaches that of the 8660C/86602B/86632B or 8640B.

Output Characteristics

Power output, harmonics, spurious outputs, RF noise, etc. are determined by the 8660C with 86602B and 86632B or the 8640B.

Receiver

Magnitude and phase characteristics are unchanged with the exception of the dynamic range specification.

Delay Characteristics

Accuracy: $\pm 3\%$ of reading ± 3 units. Units: 1μ s for 0.5-1300 MHz; 10μ s for 0.5-130 MHz; 100μ s for 0.5-13 MHz.

Range, resolution and aperture: (8660C/86602B/86632B or 86640B)

(8505A indicated units x 1000)

	8505 Frequency Range (MHz)		
	0.5-13	0.5-130	0.5-1300
Range	0-80 ms	0-8 ms	0-800 μ s
Resolution: CRT & Digital Marker Digital Marker with Delay Switch Setting	100 μ s 10 μ s <1 ms	10 μ s 1 μ s $<100 \mu$ s	1 μ s 100 ns $<10 \mu$ s
Aperture ¹	1.5 kHz	2.0 kHz	4.0 kHz

Electrical Length Characteristics

Accuracy: $\pm 3\%$ of reading $\pm 3\%$ of range.

Calibrated electrical length, range, and resolution: (8660C/86602B/86632B or 8640): (8505A digital readouts x 1000) give electrical length 1000 times larger and resolution divided by 1000.

General Characteristics

RF Inputs

L.O. drive input level: 10 dBm ± 2 dB (Rear panel BNC).

RF drive input level: 0 dBm ± 2 dB (Rear panel BNC).

Tuneable FM output: ± 1.3 V maximum (rear panel BNC with output level controlled by $\pm \Delta F$ control on front panel of 8505A). ± 1.3 V output is obtained independent of the frequency range switch setting.

Capture range of phase-lock loop: 100 kHz (0.5-13 MHz Range); 400 kHz (0.5-130 MHz Range); 4 MHz (0.5-1300 MHz Range).

Standard/phase-lock operation: rear panel switch can disable all phase-lock circuitry when using the instrument in its standard (non phase-lock) operating mode.

¹Typical measurement Aperture using linear FM modulation technique.

²Vernier provides continuous adjustment of electrical length. Calibrated Electrical Length Linearity: $\Delta \phi = 0.7\% \times 1.2 f$ (MHz) x 1 (meters).

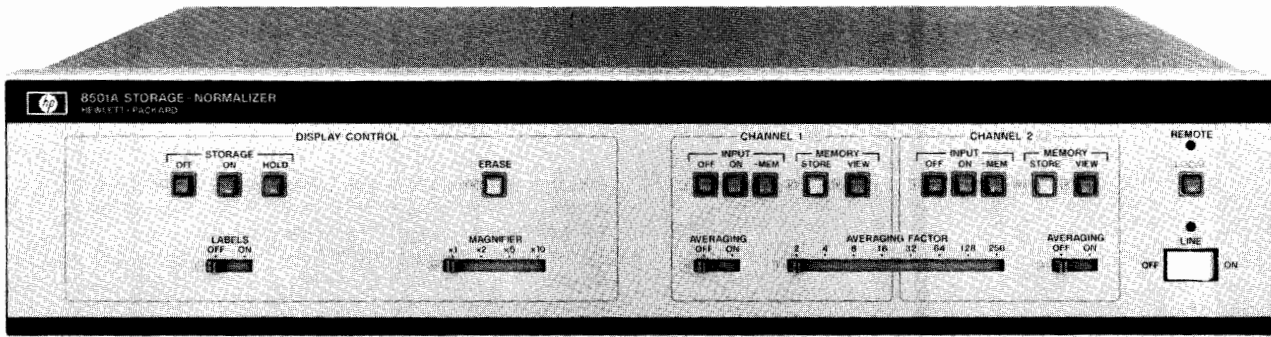

8501A



Description

The 8501A high performance Storage-Normalizer is a dedicated accessory that extends the measurement capability of your HP 8505A RF Network Analyzer (500 kHz to 1.3 GHz). Flicker free displays with digital storage and CRT annotation of major control settings provide convenient easy documentation. Using normalization, frequency response errors are simply removed. In addition the 8501A can digitally average signals to dramatically improve signal-to-noise ratios and magnify the display for high accuracy measurements. With a desktop computing controller, computer graphics capability is added to the 8505A for displaying corrected data, operator messages, or computer programs.

8501A Specifications

Display

Rectangular displays

Horizontal display resolution: two display channels, 500 points per channel (0.2% of full scale, 0.24 mm).

Vertical display resolution: 500 points displayed full scale (0.2% of full scale) plus a 50% overrange (250 points) both above and below full screen.

Polar displays

Display resolution: two display channels, 250 points per polar display (0.2% of full scale, 0.2 mm in X and Y).

Display tracking: visual offsets between direct 8505A and stored displays are approximately $\pm \frac{1}{2}$ CRT minor division (± 1 mm).

Horizontal input sweep times: 100 sec max/10 ms min.

Conversion time: 10 ms max for 500 ± 2 data points (20 μ s per point).

Display refresh time: nominally 20 ms depending upon information displayed.

Line generator: a line generation technique is used to connect points on a CRT display, yielding a smooth continuous trace.

Markers: all five markers are also available in the digital display mode.

Output

Auxiliary outputs XYZ: (BNC female connectors on rear panel).

X—1 V full screen, 83 mV/div (12 div).

Y—1 V full screen, 100 mV/div (10 div).

Z—-1 volt blanks display, +2 volt unblanks display. (Signal compatible for all HP CRT displays such as 1332, 1304, or 1310).

Offsets: The X, Y, and polar display offsets can be adjusted over a $\pm 10\%$ range of screen by means of potentiometers on the rear panel of the 8501A.

Labeling interface: all major control settings of the 8505A and 8503A and phase-lock indication are displayed on the CRT.

HP-IB Interface

HP-IB Interface capabilities

Remote programming

Learn mode: this feature provides the ability to output the current instrument state to a computing controller.

Input data: data for graphics or other purposes can be sent to the 8501A at a rate of:

ASCII mode: 600 points per second.

Binary mode: 10000 points per second.

Output data: data can be read from the 8501A at a rate of:

ASCII mode: 800 points per second.

Binary mode: 9000 points per second.

Graphics: data for graphics can be read into the 8501A and viewed in two types of displays.

Text displays: 22 lines of text with 54 characters per line can be displayed on the CRT.

Vector display: lines can be drawn on the display between any two points with a resolution of 432 points in x and 360 points in y (nominal).

General

Display controls

Storage Off: the 8501A is bypassed so the display returns to normal analog operation.

Storage On: turns on digitally stored display.

Storage Hold: the current display is not updated and is frozen for CRT photography or further analysis.

Erase: display and memory are erased.

Labels: switches all display labeling on or off.

Magnifier: expands the display by a factor of 1, 2, 5, or 10.

Processing functions (Channel 1 and 2)

Input Off: display of channel 1 (2) is blanked.

Input On: channel 1 (2) measurement is displayed.

Input Mem: the difference between the channel 1 (2) measurement and the stored memory content is displayed (normalization).

Memory Store: the current measurement is stored in memory.

Memory View: the stored memory content is displayed.

Averaging: the data averaging function for channel 1 (2) is switched on or off.

Averaging Factor: the degree of averaging is selectable from 2, 4, 8 . . . to 256. The current averaged trace is always displayed and updated at the sweep rate.

Local: returns the 8501A control to the front panel from remote HP-IB control.

Includes: 0.5 m HP-IB cable and the processor interconnect cable.

Accessories: the 11864A Accessory Kit provides the labeling interface boards and connectors for the 8505A. 8505A Opt 007 has these boards and connectors installed.

Power: selection of 100, 120, 220, or 240 V $\pm 5\%$ -10%, 50 to 60 Hz and < 140 VA (< 140 watts).

Size: 90 H x 426 W x 534 mm D (3.5 x 16.75 x 21.0 in.).

Weight: net, 12.25 kg (27 lb). Shipping, 14 kg (31 lb).

NETWORK ANALYZERS

RF Network Analyzer, 500 kHz to 1.3 GHz (cont.)

Model 8505A

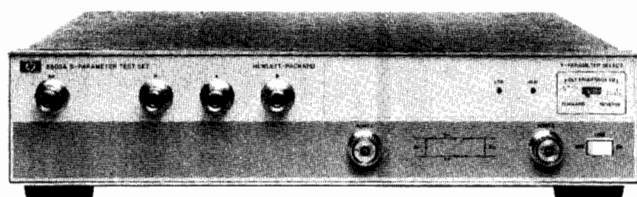

8503A

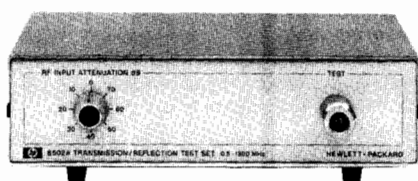

8502A



11850A



11851A

8502A 50Ω Transmission/Reflection Test Set

8502B 75Ω Transmission/Reflection Test Set

Frequency range: 500 kHz to 1.3 GHz.

Impedance: 8502A, 50Ω; 8502B 75Ω.

Directivity: ≥ 40 dB.

Frequency Response

Transmission: $\leq \pm 0.8$ dB and $\leq \pm 8^\circ$.

Reflection: $\leq \pm 1.5$ dB and $\leq 15^\circ$ from 0.5–1300 MHz; $\leq \pm 10^\circ$ from 2–1300 MHz.

Port Match

Test port: ≥ 26 dB return loss from 2–1300 MHz (≥ 24 dB for 8502B); ≥ 20 dB return loss from 0.5–2 MHz (≥ 18 dB for 8502B).

Test port open/short ratio: ± 0.75 dB and $\pm 6^\circ$ from 2–1000 MHz (± 0.9 dB and $\pm 7.5^\circ$ for 8502B); ± 0.9 dB and $\pm 7.5^\circ$ from 1000–1300 MHz; ± 1.25 dB and $\pm 10^\circ$ from 0.5–2 MHz.

Reference and reflection ports: ≥ 25 dB return loss from 2–1000 MHz; ≥ 23 dB return loss from 0.5–1300 MHz.

Input port: ≥ 23 dB return loss.

Nominal insertion loss:

Input to Test Port: 13 dB (8502A), 19 dB (8502B).

Input to Reference Port: 19 dB (8502A), 19 dB (8502B).

Input to Reflection Port: 19 dB (8502A), 31 dB (8502B).

Maximum operating level: +20 dBm.

Damage level: 1 watt CW.

RF Attenuator range: 0 to 70 dB in 10-dB steps.

Connectors test port: 50Ω Type N Female for 8502A and 75Ω Type N Female for 8502B; all other RF ports 50Ω Type N Female; Bias input, BNC Female.

DC Bias input: ± 30 V dc and ± 200 mA.

Includes: 8502B includes 50Ω/75Ω minimum loss pad.

Recommended accessory: 11851A RF Cable Kit for either 8502A or 8502B.

Size: 61.5 H x 101 W x 204 mm D (2.44 x 7.5 x 8.0 in.).

Weight: net, 1.7 kg (3.25 lb). Shipping, 3.1 kg (7 lb).

8503A 50Ω S-Parameter Test Set

8503B 75Ω S-Parameter Test Set

Frequency range: 500 kHz to 1.3 GHz.

Impedance: 8503A, 50Ω; 8503B, 75Ω.

Directivity: ≥ 40 dB.

Frequency Response

Transmission (S_{12} , S_{21}): ± 1 dB, $\pm 12^\circ$ from 0.5–1300 MHz.

Reflection (S_{11} , S_{22}): ± 2 dB, $\pm 20^\circ$ from 0.5–1300 MHz; $\pm 15^\circ$ from 2–1300 MHz.

Port Match

Test ports 1 and 2: ≥ 26 dB return loss from 2–1300 MHz (≥ 24 dB for 8503B), ≥ 20 dB return loss from 0.5–2 MHz (≥ 18 dB for 8503B).

Test port 1 and 2 Open/Short Ratio: $\leq \pm 0.75$ dB and $\pm 6^\circ$ from 2–1000 MHz (± 0.9 dB and $\pm 7.5^\circ$ for 8503B); $\leq \pm 0.9$ dB and 7.5° from 1000–1300 MHz; ± 1.25 dB and $\pm 10^\circ$ from 0.5–2 MHz.

Reference and return ports: ≥ 23 dB return loss from 2–1000 MHz; ≥ 20 dB return loss from 0.5–2 MHz and 1000–1300 MHz.

RF input port: 20 dB return loss from 0.5–1300 MHz.

Maximum operating level: +20 dBm.

Damage level: 1 watt CW.

Connectors: test ports, 50Ω APC-7 for 8503A and 75Ω Type-N Female for 8503B; all other RF connectors, 50Ω Type-N Female; Bias inputs BNC Female.

DC Bias input: 30 V dc, ± 200 mA.

Includes: four 19 cm (7.5") cables for connection to 8505A.

Recommended accessory: 11857A 50Ω Test Port Extension Cables or 11857B/C 75Ω Test Port Extension Cables.

Programming: Programming via HP-IB. 0.5 m HP-IB cable included.

Power: 100, 120, 220, or 240 V +5%–10%, 50 or 60 Hz. Approx. 10 watts (15 watts for 8503B).

Size: 90 H x 426 W x 553 mm D (3.5 x 16.75 x 21.0 in.).

Weight: net, 9.1 kg (20 lb). Shipping, 11.3 kg (25 lb).

Accessories

11850A 50Ω Power Splitter

11850B 75Ω Power Splitter

Frequency range: DC to 1.3 GHz.

Impedance: 11850A, 50Ω; 11850B, 75Ω.

Tracking between any two output ports: ≤ 0.1 dB and $\leq 1.5^\circ$.

Equivalent source match (ratio or leveling): ≥ 32 dB return loss (≤ 1.05 SWR).

Input port match: ≥ 20 dB return loss.

Nominal insertion loss: 9.54 dB for 11850A; 7.78 dB for 11850B.

Frequency response absolute: Input to Output ≤ 0.2 dB.

Maximum operating level: +20 dBm.

Burn-out level: ≥ 1 watt CW.

Connectors: 11850A, 50Ω Type N female; 11850B, three outputs 75Ω Type N female, RF input 50Ω Type N female.

Recommended accessory: 11851A RF Cable Kit.

Includes: 11850B includes three (3) 50Ω/75Ω Minimum Loss Pads

Size: 46 H x 67 W x 67 mm D (1.88 x 2.63 x 2.63 in.).

Weight: net, 1.8 kg (4 lb). Shipping, 3.1 kg (7 lb).



11851A RF Cable Kit

General: Three 610 mm (24 in.) 50Ω cables phase matched to 4° at 1.3 GHz and one cable 860 mm (34 in.). Connectors are Type N Male. Recommended for use with 8502A/B Transmission/Reflection Test Set and 11850A/B Power Splitter.

Weight: net, 0.91 kg (2 lb). Shipping, 1.36 kg (3 lb)

11852A 50Ω/75Ω Minimum Loss Pad

General: the 11852A is a low SWR minimum loss pad required for transmission measurements on 75Ω devices with 8505A receiver (50Ω).

Frequency range: DC to 1.3 GHz.

Insertion loss: 5.7 dB.

Return loss: 75Ω side, 50Ω side terminated: Typically ≥ 34 dB (≤ 1.04 SWR). 50Ω side, 75Ω side terminated: Typically ≥ 30 dB (≤ 1.06 SWR).

Typical Flatness: ≤ 0.1 dB from DC to 1.3 GHz.

Maximum input power: 250 mW (+24 dBm).

Connectors: 50Ω Type N female and 75Ω Type N male.

Size: 14 D x 70 mm L (0.56 x 2.75 in.).

Weight: net, 0.11 kg (4 oz). Shipping, 0.26 kg (9 oz).

11853A 50Ω Type N Accessory Kit

General: the 11853A furnishes the RF components required for measurement of devices with 50 Type N Connectors using the 11850A, 8502A, or 8503A (8503A also requires the 85032A). Kit contains a Type N Female short, a Type N Male short, two Type N Male barrels, two Type N Female barrels and storage case.

Weight: net, 0.91 kg (2 lb). Shipping, 1.36 kg (3 lb).

11854A 50Ω BNC Accessory Kit

General: the 11854A furnishes the RF components required for measurement of devices with 50 BNC Connectors using the 11850A, 8502A, or 8503A (8503A also requires the 85032A). Kit contains two Type N Male to BNC Female adapters, two Type N Male to BNC Male adapters, two Type N Female to BNC Female adapters, two Type N Female to BNC Male adapters, a BNC Male short and storage case.

Weight: net, 1.13 kg (2½ lb).

11855A 75Ω Type N Accessory Kit

General: the 11855A provides the RF connecting hardware generally required for measurement of devices with 75Ω Type N connectors using the 8502B, 8503B or 11850B. Kit contains two 75Ω Type N Male barrels, two Type N Female barrels, a 75Ω Type N Female short, a 75Ω Type N Male short, a 75Ω Type N Male termination, and storage case.

Weight: net, 0.91 kg (2 lb). Shipping, 1.36 kg (3 lb).

11856A 75Ω BNC Accessory Kit

General: the 11856A provides the RF connecting hardware generally required for measurement of devices with 75Ω BNC connectors using the 8502B, 11850B, or 8503B. Kit contains two Type N Male to BNC Female adapters, two Type N Male to BNC Male adapters, two Type N Female to BNC Female adapters, two Type N Female to BNC Male adapters, a BNC Male short, a 75Ω BNC Male termination, and storage case.

Weight: net, 0.91 kg (2 lb). Shipping, 1.36 kg (3 lb).

11857A 50Ω APC-7 Test Port Extension Cables

General: two precision 61 cm (24 in.) cables, phase matched to 4° at 1.3 GHz for use with 8503A S-parameter test set. Connectors are 50Ω APC-7.

Weight: net, 0.91 kg (2 lb). Shipping, 2.3 kg (5 lb).

11857B 75Ω Type N Test Port Extension Cables

General: two precision 61 cm (24 in.) cables, phase matched to 2° at 1.3 GHz for use with 8503B S-parameter test set. One cable has 75Ω Type N Male connectors on both ends; the other has one Type N Male and one Type N Female connector.

Weight: net, 0.91 kg (2 lb). Shipping, 2.3 kg (5 lb).

11858A Transistor Fixture Adapter

General: the 11858A adapts the 11600B and 11602B transistor Fixtures (vertical test port configuration) to the 8503A S-parameter test set. Connectors are APC-7.

Weight: net, 0.91 kg (2 lb). Shipping, 1.36 kg (3 lb).

Ordering Information

	Price
8505A* RF Network Analyzer	\$35,750
Opt 005: Phase Lock	\$1,000
Opt 007: Labeling Interface	\$600
Opt 908: Rack Mounting Kit (for use without front handles)	\$50
Opt 910: Extra Manual	\$75
Opt 913: Rack Mounting Kit	\$62
8503A* 50Ω S-Parameter Test Set	\$5,600
Opt 908: Rack Mounting Kit (for use without front handles)	\$32
Opt 910: Extra Manuals	\$10
Opt 913: Rack Mounting Kit	\$20
8503B* 75Ω S-Parameter Test Set	\$5,600
Opt 908: Rack Mounting Kit (for use without front handles)	\$32
Opt 910: Extra Manual	\$10
Opt 913: Rack Mounting Kit	\$20
8501A* Storage Normalizer	\$6,100
Opt 908: Rack Mounting Kit (for use without front handles)	\$32
Opt 910: Extra Manual	\$25
Opt 913: Rack Mounting Kit	\$20
8502A 50Ω Transmission/Reflection Test Set	\$2,250
Opt 910: Extra Manual	\$6
8502B 75Ω Transmission/Reflection Test Set	\$2,250
Opt 910: Extra Manual	\$6
11850A 50Ω Power Splitter	\$675
11850B 75Ω Power Splitter	\$675
11851A RF Cable Kit	\$600
11852A 50Ω to 75Ω Minimum Loss Pad	\$140
11853A 50Ω Type N Accessory Kit	\$150
11854A 50Ω BNC Accessory Kit	\$165
11855A 75Ω Type N Accessory Kit	\$200
11856A 75Ω BNC Accessory Kit	\$260
11857A 50Ω APC-7 Test Port Extension Cables	\$725
11857B 75Ω Type N Test Port Extension Cables	\$1,175
11858A Transistor Fixture Adapter	\$575
11864A Labeling Interface Kit	\$725

*Front Handles are Standard

NETWORK ANALYZERS

Automatic Network Analyzers, 500 kHz to 1.3 GHz

Models 8507B/C

- Improve productivity in lab and factory
- Accuracy enhancement
- Ease of operation via HP-IB
- 9825T or 9845T Desktop Computer
- Learn mode
- Graphics Transfer with 8507C

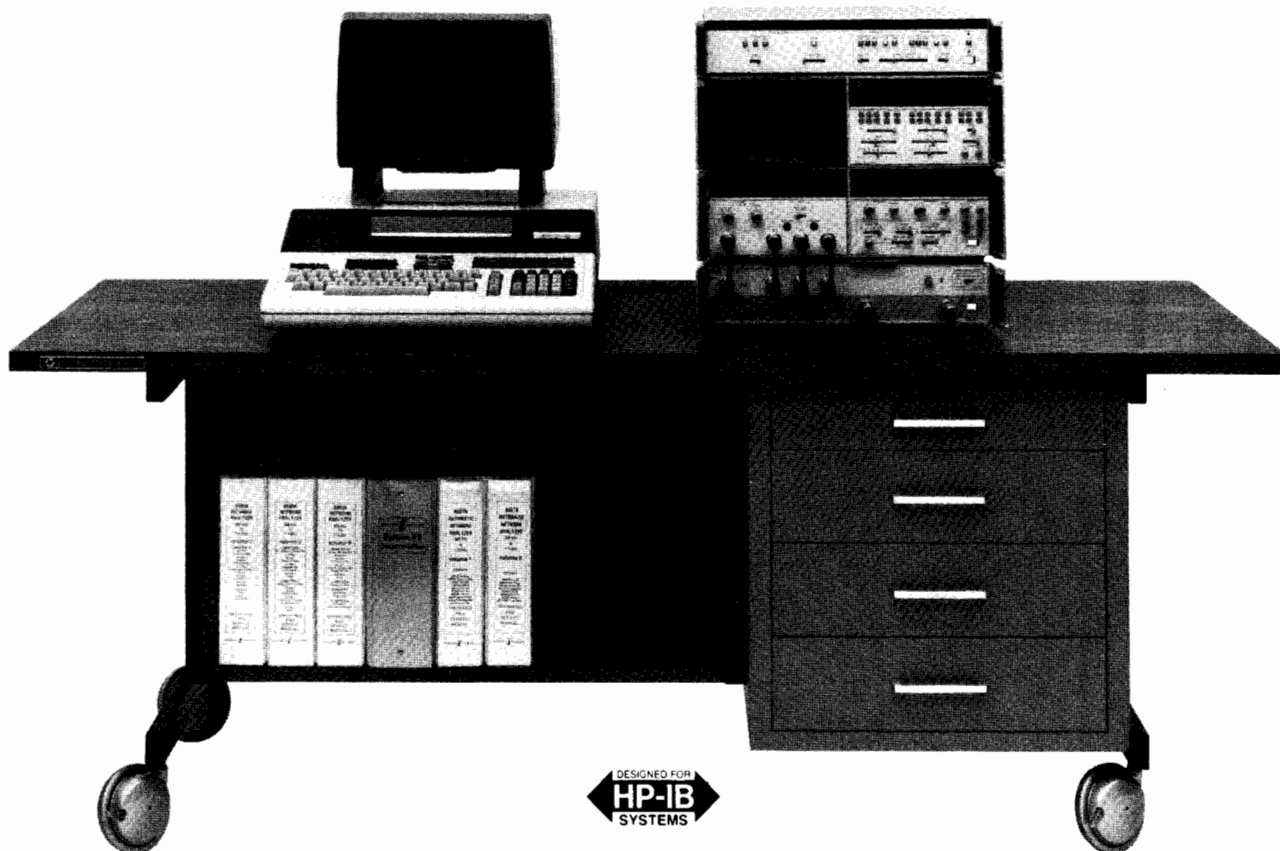

8507C

Description

Two factory-configured automatic systems based on the 8505A Network Analyzer are available. The 8507B is controlled by the 9825T Desktop Computer; the 8507C is controlled by the 9845T. Mating the versatile, easy-to-use desktop computer with the completely programmable network analyzer produces a powerful RF network measurement tool for both lab and production uses.

Cost Effective Solutions

In laboratory applications, engineers gain greater circuit insight via the speed and ease with which the 8507B/C accumulate and summarize data. With only a few hours training, engineers with no previous programming experience have been able to write customized programs which solve specialized measurement problems. In production environments, the 8507B/C can dramatically reduce the time and cost of making complicated limit tests on all types of components. Testing programs with built-in operator instructions can minimize training cost, assure uniform test procedures and eliminate subjective decisions.

Simplicity and Flexibility of HP-IB

Configuration of the standard 8507B/C or your own customized system is a simple matter since it is programmed via the Hewlett-Packard Interface Bus. For example, perhaps your RF measurement application requires a programmable power supply for transistor biasing or a digital voltmeter. Simply choose an instrument from the selection of HP-IB interfaceable instruments and add it to your 8507B/C using universal HP-IB cables.

It is equally easy to get started making measurements since the 8507B/C come with software that complements the Hewlett-Packard hardware. Included are programs for accuracy enhancement and general network analyzer applications. In addition, a system check-out program is provided. This is all made possible because HP-IB is not just IEEE-488, but the hardware, documentation and support that delivers the shortest path to a measurement system.

Learn Mode Operation

The "Learn" mode of operation has extended traditional automatic operation to a new level of operator convenience. The desktop computer can accept (Learn) a data string from the network analyzer which defines all of the manually set front panel control settings. This is accomplished by a single keystroke. Once stored in the desktop computer (or permanently recorded on a cartridge) this data string can then be used to automatically return the network analyzer to its exact original test conditions. And this can all be done without the operator ever writing a single program line!

Programmability Features

- 1) The unique marker mode operation provides a real time display simultaneously with digital data logging. This mode insures that no glitches are missed, even when taking a limited number of data points.
- 2) The human-engineered HP-IB coding alleviates complex code tables. To program a function, simply type its name (shortened to first letter if you like) and its switch position number (numbered 1 to N left to right).

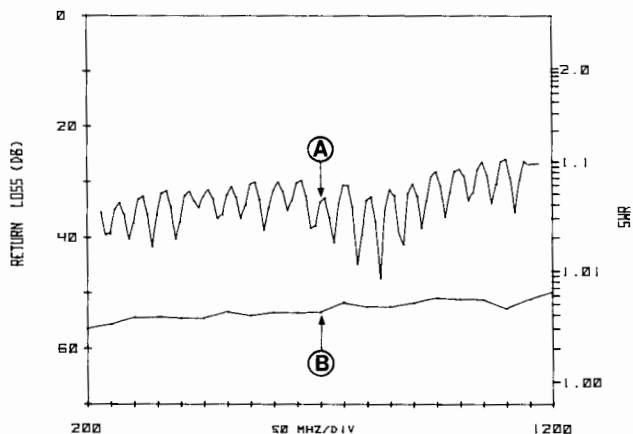

Accuracy Enhancement

Each 8507B/C system is supplied with a program that permits frequency tracking, mismatch, and directivity errors to be characterized by applying known standards. These stored system errors are then removed from the measurement of the unknown to provide a degree of accuracy exceeding that possible with the standard 8505A.

An Example

The plots on the left show the result of software accuracy enhancement. Curve A depicts raw measurements on a 50 dB return loss termination at the end of a six-foot RG 214 cable—a typical application problem in testing in temperature chambers. Curve B shows the results after calibrating at the end of the cable—a 25 dB improvement.

Data in the Form you Need

With the desktop computers, it is a simple matter to obtain customized printed or plotted outputs. Or you may want to store data on tape for later analysis. Data can be analyzed or statistically summarized directly, bypassing the laborious and error-prone task of manually recording and re-entering data. Data reformatting such as converting return loss to SWR or S-parameters to y-parameters can be accomplished also.

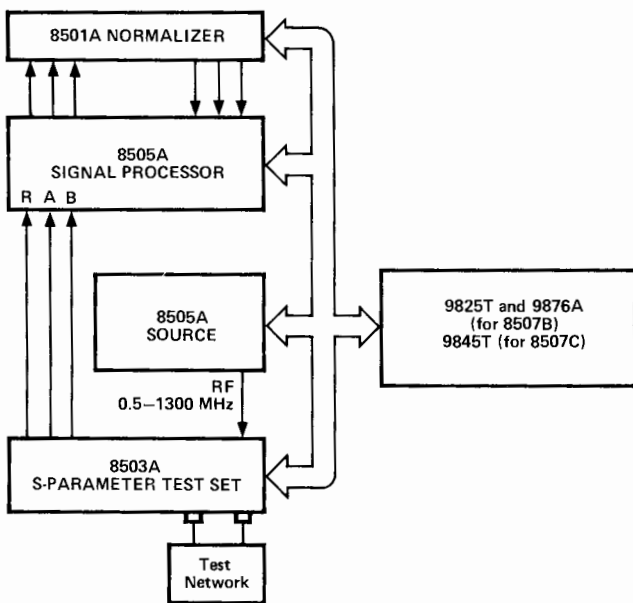

8507B/C Automatic Network Analyzers

Includes:

- 8505A Network Analyzer
- 8501A Storage Normalizer
- 8503A S-Parameter Test Set
- APC-7 Calibration Kit (85031A)
- Systems Table and Cables
- System Assembly and check-out

And with the 8507B:

- 9825T Desktop Computer (62K bytes memory) with String-Advanced Programming, Plotter-General I/O—Extended I/O ROMS, 9876A Printer, and 88076A cradle.
- HP-IB interface card, 98034A

With the 8507C:

- 9845T Desktop Computer with 187k bytes memory, opt. 204
- Graphics ROM & subsystem, opt. 311, opt. 700, I/O ROM, opt. 312
- Second tape cartridge drive, opt. 600
- Thermal line printer, opt. 560
- HP-IB interface card, 98034A

Power: 8507B—115 or 230 V, 50–60 Hz, 750 VA.

8507C—115 or 230 V, 50–60 Hz, 735 VA

Weight: 8507B—net 227 kg (500 lb). Shipping, 272 kg (600 lb)

8507C—net 255 kg (561 lb). Shipping, 312 kg (686 lb)

Ordering Information

	Price
8507B Automatic Network Analyzer	\$66,750
Opt 002: Delete Systems Table	less \$900
Opt 003: Delete 9825T Calculator	less \$14,225
Opt 005: Phase lock	\$1,000
Opt 910: Extra Set of Manuals	\$175
Opt 913: Rack Mounting Kit	\$102
8507C Automatic Network Analyzer	\$78,240
Opt 002: Delete Systems Table	less \$900
Opt 003: Delete 9845T	less \$24,815
Opt 005: Phase Lock	\$1,000
Opt 910: Extra Set of Manuals	\$200
Opt 913: Rack Mounting Kit	\$102
85010B Basic Measurements Program Pac for 8505A, 8501A, 8503A, and 9825T	\$100
85030B Applications Pac Software for 8505A/8503A/9845T	\$250
85030C Applications Pac Software for 8505A/8501A/8503A/9845T	\$250
85031A Verification/APC-7 Calibration Kit (Included with 8507B/C)	\$600
85032A 50Ω Type-N Calibration Kit	\$83
85033A SMA Calibration Kit	\$700
85036A 75Ω Type-N Calibration Kit	\$1,200

8507B/C Calibration Kits

85031A Verification and APC-7 Calibration Kits

Included with 8507B/C. Contains Precision APC-7 Load, APC-7 Short, and two verification standards.

85032A Type N Calibration Kit

For use with 8507B/C. Contains 2 APC-7 to N-Male Adapters, 2 APC-7 to N-Female Adapters, 1 N-Male Load, 1 N-Female Load, 1 N-Female Short, 1 N-Male Short.

85033A SMA Calibration Kit

For use with 8507B/C. Contains 2 APC-7 to SMA-Male Adapters, 2 APC-7 to SMA-Female Adapters, 1 SMA-Male Load, 1 SMA-Female Load, 1 SMA-Female Short, and 1 SMA-Male Short.

85036A 75Ω Type N Calibration Kit

For use with the 8507B/C Opt E75 75Ω Automatic Network Analyzer. Contains 1 Type N Male Termination, 1 Type N Female Termination, 1 Type N Male Short, 1 Type N Female Short, 1 Type N Male Barrel, and 1 Type N Female Barrel.



NETWORK ANALYZERS

RF Network Analyzer System, 100 kHz to 110 MHz

Model 8407 system

- Complete swept characterization of linear networks
- Modular system flexibility
- 50Ω and 75Ω measurements
- Digital storage

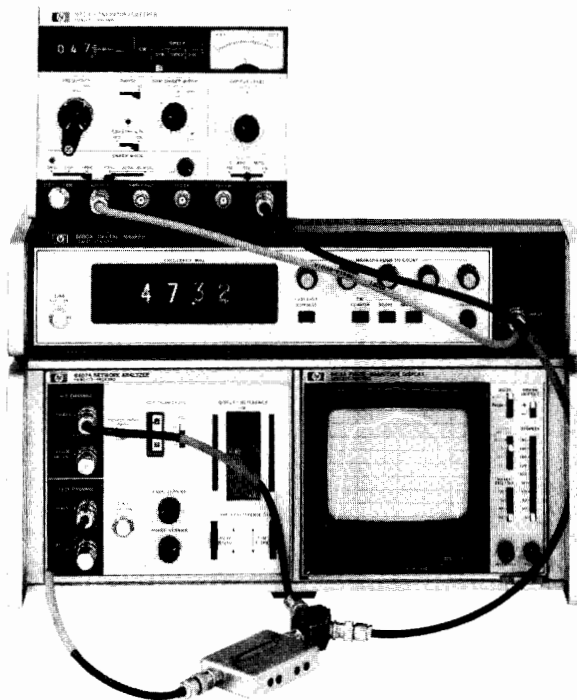

Swept measurements for either designing or testing are made with ease by HP's versatile 8407 Network Analyzer System. Since phase as well as magnitude is measured by this Network Analyzer, the behavior of both active and passive linear networks can be completely characterized from 100 kHz to 110 MHz by swept measurement.

Measurements of gain, loss, phase shift (compute a group delay), return loss, and complex reflection coefficient are all possible in either 50Ω or 75Ω systems. These measurements allow the linear behavior of the networks under test to be completely characterized by their complex S-Parameters. Swept complex impedance [Z] and θ as well as voltage and current transfer functions are also measured quickly and easily by the 8407 system. Typical linear networks designed and tested with the 8407 are filters, amplifiers, attenuators, antennas, detectors, cables, and recording heads.

Much of the 8407's versatility stems from its modular construction which allows the system to perform a variety of measurements or be economically tailored to one application. The basic instruments of the 8407 system are: The HP 8407A Network Analyzer, one of two REQUIRED sources (HP 8601A Sweeper/Generator or HP 8690B/8698B Sweep Oscillator), choice of two plug-in displays (HP 8412A Phase-Magnitude Display or HP 8414A Polar Display), an optional digital marker (HP 8600A), and one of four transducers (HP 11652A, 11654A, or 1121A) depending on the measurement. Because the 8407A is a tracking receiver, the HP 8601A and HP 8690B/8698B are the only sources providing the VTO output required to operate the network analyzer. Thus, an operating system must be configured with one of the required sources, the network analyzer, a display and one or more of the transducers depending on the device under test and the network parameters desired.

Specifications

8407A

General: 8407A is a two input tracking receiver, using both inputs (reference and test channels) to form their magnitude ratio and phase difference before routing to display.

Frequency range: 0.1–110 MHz.

Impedance: 50Ω, SWR < 1.08; Option 008: 75 Ω, SWR < 1.08.

Dynamic range: 80 dB.

Test input: DIRECT –10 to –90 dBm signal range. ATTENUATED, +20 to –50 dBm signal range. Damage level +26 dBm/50 V dc.

Reference input: DIRECT level required, –10 to –60 dBm. ATTENUATED level required +20 to –20 dBm. Damage level +26 dBm/50 V dc.

Amplitude accuracy: FREQUENCY RESPONSE ± 0.2 dB for DIRECT input (test input > –60 dBm), 0.1–110 MHz; ± 0.05 dB over any 10 MHz portion; may be calibrated out. Typically ± 0.05 dB for DIRECT inputs (REFERENCE level of –10 dBm). DISPLAY REFERENCE, <0.05 dB/1 dB step, total error ≤ 0.1 dB; <0.1 dB/10 dB step, total error ≤ 0.25 dB. ATTENUATED INPUTS, 40 dB ± 0.5 dB. REFERENCE CHANNEL GAIN CONTROL, 20 dB and 40 dB steps ± 0.5 dB/step. CROSSTALK, <0.03 dB when test/ref = –40 dB to <4 dB when test/ref = –80 dB.

Power: 65 watts, 50–60 Hz, 115/230 $\pm 10\%$ V ac.

Weight: net, 14.6 kg (32 lb). Shipping, 17.8 kg (39 lb).

8412A

General: plug-in PHASE-MAGNITUDE CRT Display. Displays magnitude and/or phase vs. frequency.

Amplitude accuracy: display, 0.08 dB/dB from midscreen. Rear output: 0.03 dB/dB variation from 0 volt output.

Phase Accuracy: DISPLAY, 0.065°/degree from midscreen. PHASE OFFSET, 0.3°/20° step, $\leq 3^\circ$ for 360° change, positive or negative direction. VS. DISPLAYED AMPLITUDE, <1°/10 dB; total <6° over 80 dB range.

Rear panel inputs: sweeping, ≤ 15 V dc. Blanking, –4 V dc blanks CRT. Z axis (marker), –5 V dc intensifies and +5 V dc blanks trace.

Power: 23 watts, supplied by 8407A.

Weight: net, 7.8 kg (17 lb). Shipping, 10 kg (22 lb).

Detailed Specifications on page 503.

8750A

General: the 8750A Storage-Normalizer provides digitally stored and normalized CRT displays when used with the 8412A Phase-Magnitude Display. Measurements are faster, easier, and more accurate when the 8750A is employed because the CRT is flicker-free and frequency response errors are eliminated. The 8750A is not compatible with the 8414A Polar Display.

Power: selection of 100, 120, 220, or 240 V $\pm 5\%$ –10%, 48 to 440 Hz and ≤ 20 VA (≤ 20 watts).

Weight: net, 2.72 kg (6 lbs). Shipping, 5.0 kg (11 lbs).

Detailed Specifications on page 501.

8414A

General: normalized POLAR coordinate display with magnitude calibration in 0.2 of full scale gradations. Full scale is determined by DISPLAY REFERENCE on 8407A; phase calibration is in 10° increments over 360° range. Smith Chart overlays available.

Accuracy: all errors in amplitude and phase due to display are contained within a circle of 3mm about measurement point.

Rear panel inputs: blanking, –4 to –10 V dc blanks CRT. Marker, intensified trace with –4 to –10 V dc.

Rear panel outputs: horizontal and vertical both ± 2.5 V for full scale deflection.

Power: 35 watts, supplied by 8407A.

Weight: net, 5.9 kg (13 lb). Shipping, 8.0 kg (18 lb).

Detailed specifications on page 503.

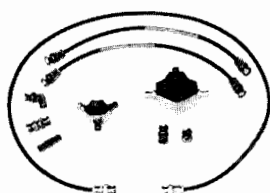

11652A

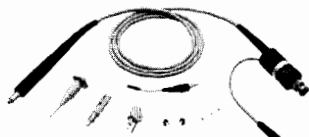

1121A

8601A

General: GENERATOR/SWEEPER operating in either CW or SWEPT modes. Sweep modes are full, variable stop frequency, and symmetrical (up to 10 MHz). Features very low residual FM, spurious, harmonics, and drift. 8601A provides the VTO signal required to operate the 8407A.

Frequency: 0.1–11 MHz in two sweep ranges, 0.1–11 MHz and 1–110 MHz.

Impedance: 50Ω VSWR < 1.2. Option 008: 75Ω. VSWR < 1.2.

Accuracy: 1% of frequency, 0.5% linearity, and 2% of sweep width.

Calibrated output: ±0.25 dB flatness over full range, output accuracy ±1 dBm from +10 to –110 dBm.

Auxiliary outputs: sweep out, blanking (for 8412 and 8414), VTO (required by 8407A), and auxiliary output (0.1–11 MHz both ranges) for 8600 counter/digital marker.

Detailed specifications on page 445.

8600A

General: DIGITAL MARKER used with 8601A generator/sweeper to provide five continuously variable markers on a display while reading out the frequency of any one marker. Six digit display.

Markers/accuracy: 5 markers accurate at desired frequency ± (0.05% sweep width + sweep stability).

Counter frequency range: 0.1–15 MHz (automatically scales up by ten when 8601A on 0.1–110 MHz range).

Detailed specifications on page 445.

11652A

General: REFLECTION-TRANSMISSION KIT containing power splitter, 8721A DIRECTIONAL BRIDGE, precision termination, calibrating short, three BNC adapters, and four matched, low-leakage cables for both transmission and reflection measurements. All 50 Ω BNC connectors, Option 008 75Ω.

Directional bridge: 8721A: 6 dB insertion loss and 6 dB coupled to auxiliary arm. Frequency response ±0.5 dB (0.1–110 MHz). Directivity >40dB (1 to 110 MHz). Load port return loss >30 dB ($\rho < 0.03$). Max input power +20 dBm. 50Ω, Option 008: 75Ω.

Power splitter: 6 dB through each arm. Max input power +20 dBm. 50 Ω.

50Ω termination: return loss >43 dB.

Weight: net, 0.7 kg (1.5 lb). Shipping, 1.2 kg (2.5 lb).

11658A

General: 50Ω to 75Ω matching resistor for matching the 50Ω of the 8407A to a 75Ω environment. Two 11658A's are very useful for frequent 50Ω to 75Ω changes. The 11658A's mount directly on the front panel, of 8407A, FREQUENCY, 0.1–110 MHz. INSERTION LOSS, 3.5 dB. RETURN LOSS, >40 dB. CONNECTORS, 50Ω BNC male and 75Ω BNC female.

Net Weight: 28 g (1 oz).

1121A

General: 1:1 active probe for making measurements without disturbing circuitry and measuring voltage transfer functions in systems different from 50Ω. 10:1 and 100:1 dividers and BNC adapter also furnished.

Frequency response: ±0.5 dB and ±2% from 0.1–110 MHz with a bandwidth (3 dB) of 1 kHz to >500 MHz and gain 0 dB ±1 dB.

Input impedance: 100 kΩ, shunt capacitance of 3 PF at 100 MHz. With 10:1 or 100:1 divider, 1 MΩ, shunt capacitance 1 PF at 100 MHz.

Output impedance: 50Ω nominal.

Maximum input: 300 mV rms, +80 V dc; with 10:1 divider, 30 V rms, ±350 V dc.

Power: supplied by 8407A through PROBE PWR jacks.

Weight: net, 0.7 kg (1.5 lb). Shipping, 1.2 kg (2.5 lb).

Ordering Information

	Price
8407A Network Analyzer	\$7100
Opt 00B: 75Ω input	add \$115
8412A Phase Magnitude Display	\$3500
8750A Storage-Normalizer	\$1890
8414A Polar Display	\$3200
8601A Sweeper/Generator	\$3950
Opt 00B: 75Ω output	add \$50
8600A Digital Marker	\$2250
11652A Reflection/Transmission Kit (50Ω)	\$575
Opt 00B: 75Ω	add \$75
11658A Matching Resistor	\$100
1121A AC Probe Kit	\$700
8721A Directional Bridge (50Ω)	\$250
Opt 00B: 75Ω	add \$20

NETWORK ANALYZERS

Vector Voltmeter

Model 8405A

- Accurate voltage and phase measurement
- 1 to 1000 MHz

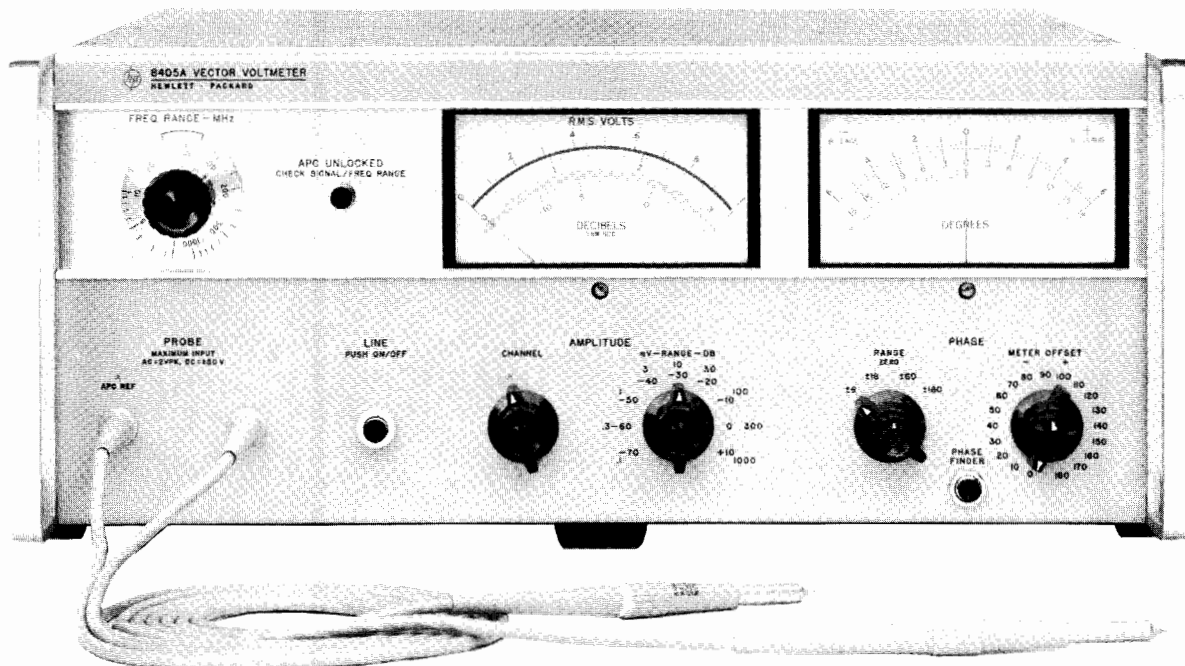

The 8405A Vector Voltmeter measures voltage vectors described by both magnitude and phase. This capability makes the 8405A a unique instrument for about any design and test application in the frequency range 1 to 1000 MHz.

In addition to absolute voltage measurements, capabilities include insertion loss and computed group delay of bandpass filters and other transmission devices, gain and phase margin of amplifiers, complex impedance of mixers, antennas, matching the electrical lengths of cables, s-parameters of transistors, amplitude modulation index, RF distortion measurements and in-circuit probing.

The 8405A achieves this measurement versatility through its two-channel capability enabling voltage magnitude measurements in either channel, thus allowing ratio measurements, and phase difference measurements between the two channels. Gain or loss in excess of 90 dB and phase measurements with 0.1° resolution over a 360° phase range are possible.

Accuracy is achieved through the 1 kHz bandwidth entailing response only to the fundamental frequency of the input signal. Also, phase-locked coherent sampling to translate 1 to 1000 MHz RF signals to 20 kHz IF signals enables accurate detection of voltage magnitude and phase. Automatic phase-locked tuning makes it possible to select the one of 21 overlapping octave ranges which contains the input signal frequency by simply rotating a switch.

Specifications

Frequency range: 1 MHz to 1 GHz in 21 overlapping octave bands; tuning automatic within each band.

Isolation between channels: 1 to 300 MHz, >100 dB; 300 to 1,000 MHz >80 dB.

Maximum input: ac, 2 V peak; dc, ± 50 V.

Input impedance (nominal): 0.1 M Ω shunted by 2.5 pF; 1 M Ω shunted by 2 pF when 11576A 10:1 Divider is used; 0.1 M Ω shunted by 5 pF when 10216A Isolator is used. AC coupled.

Voltage Range (rms)

Channel	1-10 MHz	10-500 MHz	500-1000 MHz
A	1.5 mV - 1.0 V	300 μ V - 1.0 V	500 μ V - 1.0 V
B	<20 μ V - 1.0 V	<20 μ V - 1.0 V	<20 μ V - 1.0 V

Voltmeter ranges: 100 μ V to 1 V rms full scale in 10 dB steps.

Voltage ratio accuracy: 1-200 MHz, 0.2 dB for -60 to 0 dB ranges and 0.5 dB for -70 dB to +10 dB ranges; 200-1000 MHz, 0.2 dB for -60 to -10 dB ranges, 0.5 dB for -70 dB to 0 dB ranges and 1.5 dB for +10 dB range.

Phase range: 360° indicated on zero-center meter with end-scale ranges of $\pm 180^\circ$, $\pm 60^\circ$, $\pm 18^\circ$, and $\pm 6^\circ$.

Phase resolution: 0.1° at any phase angle.

Phase meter offset: $\pm 180^\circ$ in 10° steps.

Phase accuracy: $\pm 1.5^\circ$ (equal voltage Channel A and B).

Accessories furnished: two 11576A 10:1 Dividers, two 10216A Isolators, two 10218A BNC Adapters, six ground clips for 11576A or 10216A; six replacement probe tips.

Bandwidth: 1 kHz.

Power: 115 or 230 V $\pm 10\%$, 50 to 60 Hz, 35 W.

Weight: net, 13.9 kg (31 lb). Shipping, 16.3 kg (36 lb).

Size: 177 H x 425 W x 467 mm D (7.0 in x 16.75 in x 18.38 in).

11570A Accessory Kit

50 Ω Tee: 11536A: for monitoring signals on 50 Ω transmission lines without terminating line. Kit contains two with type N RF fittings.

50 Ω Power Splitter: 11549A: all connectors Type N female.

50 Ω Termination: 908A: for terminating 50 Ω coaxial systems in their characteristic impedance.

Shorting plug: 11512A: Shorting Plug, Type N male.

Ordering Information

8405A Vector Voltmeter

Opt 002: linear dB scale

11570A Accessory Kit (measurement in 50 Ω systems only)

Price

\$4975

add \$25

\$695

- Digital storage and normalization
- Simple CRT photos and x-y recordings
- Use with HP network and spectrum analyzers

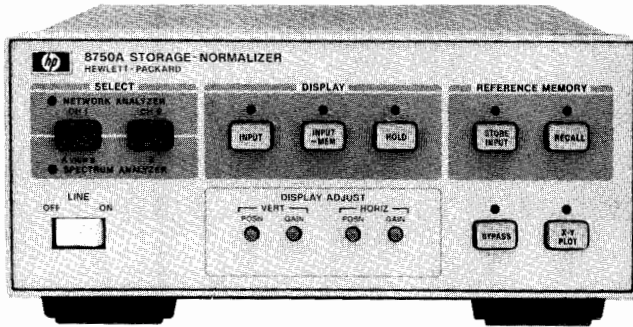

8750A

With HP's versatile 8750A Storage-Normalizer, you can make your network analyzer or spectrum analyzer measurements faster, easier, and more accurately through the simple addition of digital storage and normalization. This useful instrument accessory is directly compatible via a single interface cable with the following recently produced or appropriately modified Hewlett-Packard instruments; the 8755 Frequency Response Test Set, the 8407A/8412A, the 8410/8412A, the 8754A and the 8505A Networks Analyzers and 8557A, 8558B, 8565A and 8559A Spectrum Analyzers. A special I/O Adapter (opt 001 or opt 002) is available for interfacing instruments (like 140 Series Spectrum Analyzers) that are not directly compatible with the 8750A. An external oscilloscope can then be used for digitally stored and normalized displays. (The 8750A is not compatible with the 8414A Polar Display or the polar mode of the 8505A or the 8754A.)

In network analyzer applications, digital storage always yields a flicker-free display of the complete device response, facilitating easy adjustment of test devices under slow sweep conditions. Measurement accuracy is also improved since frequency response errors can be automatically removed through digital normalization. This effectively eliminates the need to manually record calibration traces on a CRT or x-y recorder and allows high resolution measurements of attenuator, amplifier, or filter passband flatness.

In spectrum analyzer applications, the 8750A's digital storage feature simplifies many difficult tests requiring slow scan times such as high resolution modulation measurements. Drift tests are also easy since two traces, a stored reference and the current input, can be displayed simultaneously.

Hard copy documentation can be obtained quickly and easily since data can be frozen on the CRT for straightforward CRT photography or outputted to an x-y recorder at a constant 30 second sweep rate.

Supplemental Performance Characteristics

Display

Horizontal memory resolution: two display channels, 256 points per channel (0.4% of full scale, 8 bit word)

Vertical memory resolution: 512 points displayed full scale (0.2% of full scale, 10 bit word) plus a 50% overrange (256 points) both above and below full screen.

Horizontal input sweep rates: 100 sec max./10 ms. min.

Display refresh rate: 6 ms.

Video Detection

Network analyzer: Average Detection (20 kHz).

Spectrum analyzer: Peak Detection.

Input/Output

A/D Horizontal Input

Network analyzer: 0 to 10 V nominal. Offset ± 0.5 V and Gain Adjust for 6 to 15 V sweep.

Spectrum analyzers: ± 5 V nominal. Offset ± 0.5 V and Gain Adjust for ± 4.5 to ± 5.5 V.

A/D Vertical Input

Network analyzer: ± 1 V min. and ± 2 V max, with continuous gain adjustment. Offset ± 0.3 V.

Spectrum analyzer: 0 to 0.8 V or 0 to -0.8 V. Offset ± 0.1 V and Gain Adjust $\pm 10\%$.

D/A Horizontal Output

Network analyzer: gain adjustment for 1 to 3 V peak. Offset adjustment $+0.5$ to -1.5 V.

Spectrum analyzer: gain adjustment for 1 to 3 V peak. Offset $+0.5$ to -1.5 V.

D/A Vertical Output

Network analyzer: same as Vertical Input with $\pm 10\%$ adjustment range.

Spectrum analyzer: same as Vertical Input with $\pm 10\%$ adjustment range.

X-Y Recorder Outputs

Horizontal range and accuracy: 0 ± 20 mV to 1 V nominal, settable within $\pm 3\%$ of full scale. BNC female output (rear panel).

Vertical range and accuracy: ± 4 V $\pm 3\%$ BNC female output (rear panel).

Sweep time: 30 sec per displayed trace.

Penlift output: BNC female (rear panel with open collector driver 20 V maximum.)

Controls

Select: LED display indicates Network or Spectrum Analyzer operation depending on the plug-in interface card.

Display

Input: initiates digital storage.

Input-Mem (Input minus Memory): Stored Reference trace is subtracted from input data (normalization).

Hold: freezes display for CRT photos or further analysis.

Reference Memory

Store input: current input trace is stored as Reference.

Recall: displays stored Reference trace.

Bypass: bypasses 8750A so display is returned to conventional analog operation.

X-Y Plot: initiates X-Y plots.

General

Interface Cards: The 8750A is supplied with two general plug-in interface cards. One for use with the HP Spectrum Analyzers listed above, one for use with the 8407A/8412A and 8505A Network Analyzers. When the 8750A is to be used primarily with an 8755B/C Frequency Response Test Set and 8350A/8620C Sweeper, 8410B/8412A Network Analyzer and 8350A/8620C Sweeper, or the 8754A Network Analyzer, calibration and adjustment of the 8750A to these instruments can be greatly simplified by ordering one of the plug-in interface cards dedicated to these instruments (Opt. 003 and 004.) All offset and gain adjustments are significantly reduced. When Opt. 003 or 004 are ordered the two general interface cards are also included so you have the flexibility to change your test set up at any time.

Power: selection 100, 120, 220, or 240 V $+5\%$ -10% . 48 to 440 Hz and <20 VA (<20 watts).

Size: 102 H x 212 W x 280 mm D (4 x 8.4 x 11.2 in).

Weight: net. 2.72 kg (6.1 lbs). Shipping, 5.0 kg (11 lbs).

Ordering Information

8750A Storage-Normalizer

Price

\$1750

Opt 001: BNC Interface Adapter (Deletes direct interface cable)

N/C

Opt 002: BNC Interface Adapter (Retains direct interface cable)

add \$125

Opt 003: 8755B/C or 8412A/8620C Plug-in Interface Card

add \$100

Opt 004: 8754A Plug-in Interface Card

add \$100

NETWORK ANALYZERS

Microwave Network Analyzer, 110 MHz to 40 GHz

8410 Family

- Complete microwave measurement systems
- Measures all network parameters
- Multioctave swept frequency measurements
- Eliminate harmonic and spurious responses

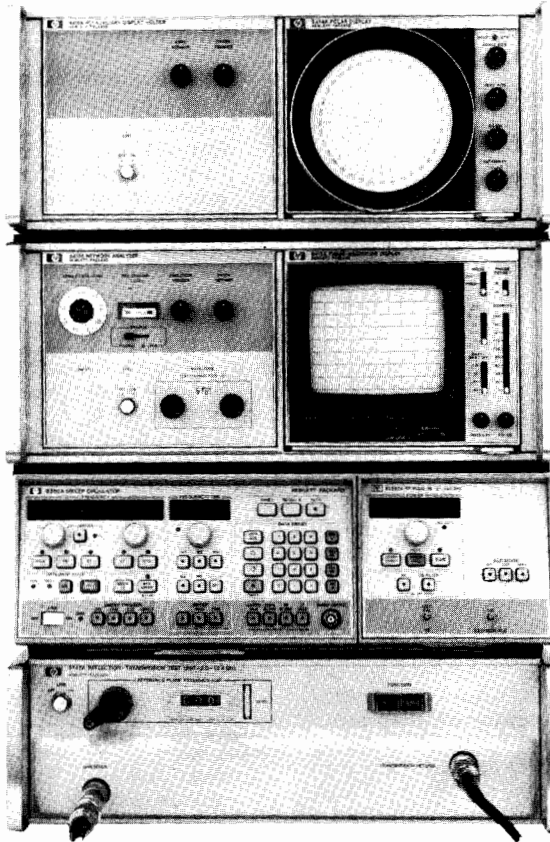

Receiver:

- 8410B** Network Analyzer
 - Opt H17** External Local Oscillator Input
 - Opt C06** Rear Panel Connection to 8411A
- 8411A** Harmonic Frequency Converter
 - Opt 018** Operation to 18 GHz

Displays:

- 8412A** Phase/Magnitude Display
- 8418A** Auxiliary Display Holder
 - Opt H01** Remote IF Attenuation
- 8414A** Polar Display
 - Opt H07** Remote Beam Center

Source:

- 8350A** Sweep Oscillator
 - Opt 001** Non-Volatile Memory
- 83590B** 2-20 GHz Sweep Oscillator Plug-In

Test Set:

- 8743B** Reflection/Transmission Test Set
 - Opt 018** Operation to 18 GHz
- 11610B** Test Port Extension Cable

General

This configuration is the basis for the high performance 8409-series automatic network analyzer described on page 509. This building-block approach to system configuration allows HP-IB accessories such as an A/D converter and relay switching instruments to be added to a manual system to allow upgrading to fully automatic applications. Refer to HP application note AN 221A for information on automating the 8410B Microwave Network Analyzer.

Receiver

The 8410B Network Analyzer and 8411A Harmonic Frequency Converter comprise the nucleus of the swept-frequency system which provides magnitude and phase measurement capability from 110 MHz to 18 GHz in coax and 12.4 to 40 GHz in waveguide. Automatic frequency locking allows continuous multioctave sweeps. Frequency conversion from RF to IF gives high sensitivity and greater than 60 dB dynamic range, free of spurious and harmonic responses. Calibrated IF substitution makes possible accurate gain or insertion loss measurements.

Displays

The 8412A Phase/Magnitude Display displays magnitude and phase versus frequency. The 8414A Polar Display provides a polar plot of magnitude and phase. These displays are interchangeable plug-ins for the 8410B mainframe. The 8418A Auxiliary Display Unit can be added to provide simultaneous rectilinear and polar display capability.

Sources

Although the 8410B can produce octave-width sweeps using any swept source, continuous multi-octave sweeps limited only by the frequency range of the test set are possible with the 8620C or 8350A Sweep Oscillators. In addition, the 8690B Sweep Oscillator family offers BWO or solid-state plug-ins—a popular choice in the waveguide bands to 40 GHz.

Test Sets

The 8745A, 8743B, and 8746B test sets contain all necessary splitters and couplers required to provide stimulus to the device under test and route the reference and reflected or transmitted signals to the receiver. Accessories allow the test sets to be configured for active and passive coaxial measurements as well as for semiconductor measurement applications.

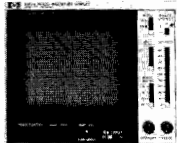
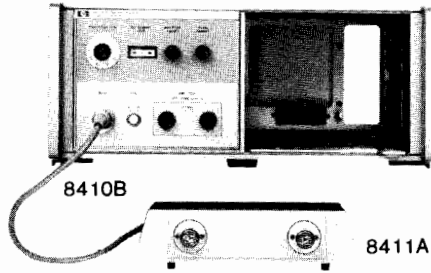

8412A



8414A

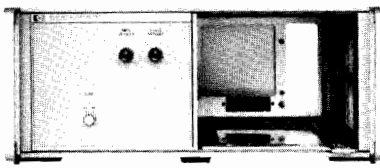

8418A

Specifications

8410B/8411A Network Analyzer

Function: 8411A converts RF signals to IF signals for processing in 8410B mainframe. 8410B is the mainframe for display plug-in units. Mainframe includes tuning circuits (octave bands or multioctave bands when used with HP 8620C or 8350A sweep oscillator), IF amplifiers and precision IF attenuator. 8410B option H17 allows injection of an external local oscillator used in automatic applications to lock the 8410 receiver to an external source such as the HP 3335A. 8410B Option C06 moves the 8411A input to the rear panel for systems use.

8410B frequency range: 0.11 to 18 GHz.

8411A frequency range: 0.11 to 12.4 GHz.

Opt 018: 0.11 to 18 GHz.

8411A input impedance: 50 ohms nominal. SWR <1.5, 0.11 to 2.0 GHz; <2.0, 2.0 to 16.0 GHz; 3, 6.0 to 18.0 GHz.

Channel isolation: >65 dB, 0.1 to 6 GHz; >60 dB, 6 to 12.4 GHz; >50 dB, 12.4 to 18 GHz.

Magnitude Range

Reference channel: -18 to -35 dBm, 0.11 to 12.4 GHz; -18 to -25 dBm from 12.4 to 18.0 GHz.

Test channel: -10 to -75 dBm from 0.11 to 12.4 GHz; -10 to -68 dBm from 12.4 to 18 GHz.

Maximum RF input to either channel: 50 mW.

IF gain control: 69 dB range in 10 dB and 1 dB steps with a maximum cumulative error of ± 0.2 dB.

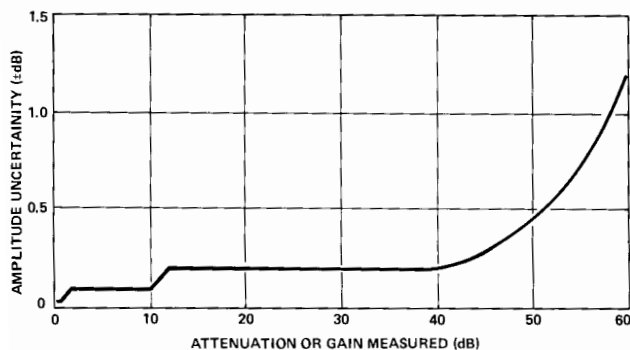

Phase

Phase range: 0 to 360°

Control: vernier control $\leq 90^\circ$

Connectors (8411A): APC-7.

Power: 115 or 230 V $\pm 10\%$, 50-60 Hz, 70 watts (includes 8411A).

Weight

8410B: net, 14.9 kg (33 lb). Shipping, 18.5 kg (41 lb).

8411A: net, 3.2 kg (7 lb). Shipping, 4.5 kg (10 lb).

Size

8410B: 191 H x 425 W x 467 mm D (7.5" x 16.75" x 18.38").

8411A: 67 x 228 W x 143 mm D (2.63" x 9" x 5.63") exclusive of connectors and cable.

8412A Phase-Magnitude Display

Function: plug in CRT display unit for 8410B. Displays relative amplitude in dB and/or relative phase in degrees between reference and test channel inputs versus frequency.

Amplitude

Range: 80 dB display range with selectable resolutions of 10, 2.5, 1 and 0.25 dB/division.

Accuracy: 0.08 dB/dB from midscreen.

Phase

Range: $\pm 180^\circ$ display range with selectable resolutions of 90, 45, 10, and 1°/division.

Accuracy: 0.065°/degree from midscreen.

Phase offset: 0.3°/20° step cumulative $< 3^\circ$.

Power: 23 watts supplied by mainframe.

Weight: net, 7.8 kg (17 lb). Shipping, 10 kg (22 lb).

Size: 152 H x 186 W x 395 mm D (6" x 7.28" x 15.56") excluding front panel knobs.

8414A Polar Display

Function: plug-in CRT display unit for 8410B. Displays amplitude and phase data in polar coordinates on 5-in. cathode ray tube.

Range: normalized polar coordinate display; magnitude calibration 20% of full scale per division. Scale factor is a function of IF setting on 8410B. Phase calibrated in 10-degree increments over 360-degree range. Option H07 allows external contact closure control of the beam center function.

Accuracy: error circle on CRT ± 3 mm.

Power: 35 watts supplied by mainframe.

Weight: net, 5.8 kg (13 lb). Shipping 8.1 kg (18 lb).

Size: 152 H x 186 W x 395 mm D (6" x 7.28" x 15.56") excluding front panel knobs.

8418A Auxiliary Display Holder

Function: the 8418A Auxiliary Display Holder provides power for operating of the 8412A, 8413A or the 8414A display units. Used in conjunction with the 8410B Network Analyzer, it provides the capability of viewing amplitude and phase readout in both rectangular and polar coordinates simultaneously. Option H01 adds a remotely programmable 0-70 dB IF attenuator required for autoranging in automatic applications.

Weight: net, 11.2 kg (25 lb). Shipping, 19.7 kg (44 lb).

Size: 177 H x 483 W x 450 mm D (6.97" x 19" x 17.13").

Ordering Information

	Price
8410B mainframe	\$5600
Opt H17: External Local Oscillator Input	add \$1000
Opt C06: Rear Panel 8411A Input	\$250
Opt 908: Rack Flange Kit	add \$25
8411A Frequency Converter	\$4500
Opt 018: 2 to 18 GHz	add \$550
8412A Phase-Magnitude Display	\$3500
8414A Polar Display	\$3200
Opt H07: Remote Beam Center	add \$300
8418A Auxiliary Display Holder	\$2200
Opt H01: Programmable 0-70 dB IF Attenuator	add \$1500
Opt 908: Rack Flange Kit	add \$25

NETWORK ANALYZERS

Test Sets and Accessories

8410 Family

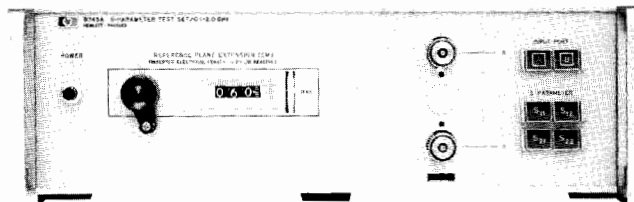

8745A

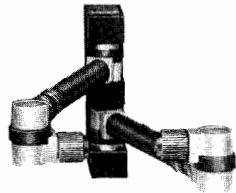

11604A

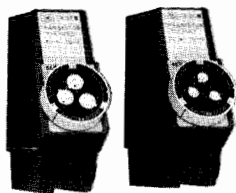

11602B

11600B

8745A S-Parameter Test Set

Function: wideband RF power splitter and reflectometer with calibrated line stretcher. Pushbutton operated for either forward or reverse transmission or reflection measurements with network analyzer.

Frequency range: 100 MHz to 2 GHz.

Impedance: 50 ohms nominal.

Source reflection coefficient: ≤ 0.057 , 0.11 to 2.0 GHz.

Termination reflection coefficient: < 0.10 , 100, to 200 MHz; < 0.063 , 200 MHz to 2.0 GHz.

Directivity: ≥ 36 dB, below 1 GHz; ≥ 32 dB, 1 to 2 GHz.

Reference plane extension: 0 to 15 cm for reflection; 0 to 30 cm for transmission.

Maximum RF power: 2 watts.

Connectors: RF input type N female; all other connectors APC-7; Option 001, type N female.

Remote programming: ground closure.

Power: 115 or 120 V $\pm 10\%$, 50 to 400 Hz, 40 watts.

Weight: net, 15.4 kg (34.25 lb). Shipping, 18.0 kg (40 lb).

Size: 140 H x 425 W x 654 mm D (5.50" x 16.75" x 25.75").

11604A Universal Extension

Function: mounts on front of 8745A; connects to device under test. Rotary air-lines and rotary joints connect to any two port geometry.

Frequency range: dc to 2 GHz.

Impedance: 50 ohms nominal.

Reflection coefficient: 0.035.

Acc. included: semi-rigid coax. cable, HP Part #11604-20021.

Weight: net, 1.8 kg (4 lb). Shipping, 2.2 kg (5 lb).

Size: 127 H x 32 W x 267 mm D (5" x 1.25" x 10.50").

11600B/11602B Transistor Fixtures

Function: mounts on front of 8745A S-parameter test set; holds devices for S-parameter measurements in a 50 ohm, coax circuit. Both fixtures provide bias for bipolar transistors and FETs. Other devices also fit the fixture (tunnel diodes, etc.).

Transistor Base Patterns

Model 11600B: accepts TO-18/TO-72 packages.

Model 11602B: accepts TO-5/TO-12 packages.

Calibration references: short circuit termination and a 50 ohm through-section.

Frequency ranges: dc to 2 GHz.

Impedance: 50 ohm nominal.

Reflection coefficient: < 0.05 , 100 MHz to 1.0 GHz; < 0.09 , 1.0 to 2 GHz.

Connectors: hybrid APC-7; Option 001, type N female.

Weight: net 1.1 kg (2.38 lb). Shipping, 1.8 kg (4 lb).

Size: 152 H x 44 W x 229 mm D (6" x 1.75" x 9").

8410S Opt 110 Specifications

Function: the 8410S option 110 measurement system configuration is described on page 509. Following are specifications describing measurement capabilities of the 8410B/8411A when used with the 8745A/11604A over the frequency range of 110 MHz to 2 GHz.

Frequency range: 0.11 to 2.0 GHz.

RF input: 20 dB range between +5 dBm and -12 dBm.

Source reflection coefficient: ≤ 0.067 , 0.11-2.0 GHz.

Termination reflection coefficient: ≤ 0.11 , 100-200 MHz; ≤ 0.07 , 200-2000 MHz.

Directivity: ≥ 28 dB 0.11-1.0 GHz; ≥ 27 dB 1.0-2.0 GHz.

Insertion loss, RF input to test port: 4 dB nominal.

Frequency Response

Transmission: typically $< \pm 0.35$ dB amplitude and $< \pm 5^\circ$ phase.

Reflection: typically $< \pm 0.06$ magnitude and $\pm 5^\circ$ phase with a short on the test port.

Transmission measurement accuracy: (see common performance specifications).

Reflection measurement accuracy (using 8414A): sources of error included in the accuracy equations are directivity, source match, and polar display accuracy.

Magnitude accuracy:

$\rho_u = \pm (0.0398 + 0.03 \rho_L + 0.067 \rho_L^2)$ 0.11-1.0 GHz.

$\rho_u = \pm (0.0447 + 0.03 \rho_L + 0.067 \rho_L^2)$ 1.0-2.0 GHz.

ρ_u = magnitude uncertainty.

ρ_L = measured reflection coefficient magnitude.

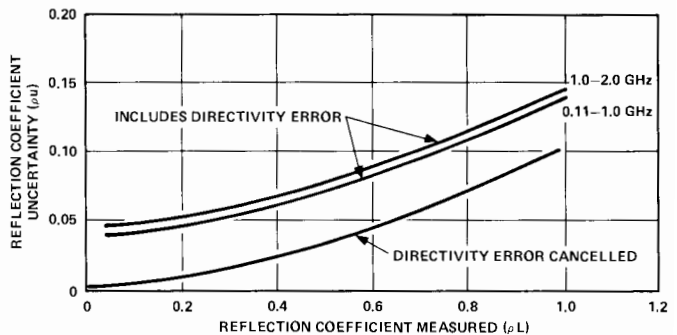

Phase accuracy:

$\Phi_u = \sin^{-1} \rho_u / \rho_L$ for $\Phi_u < 90^\circ$.

Φ_u = phase uncertainty.

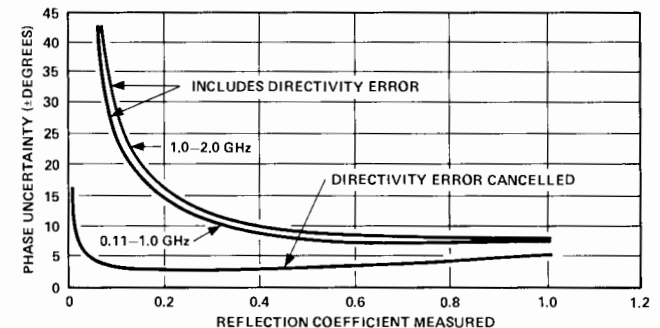

See 8410S Network Analyzer Systems Table for price and instrument breakdown.

Ordering Information

8745A Test Set

Opt 001: Type N Test Port Connectors

Opt 908: Rack Flange Kit

11604A Universal Arm Extension

11600B/11602B Transistor Fixtures

Opt 001: Type N Female Connectors

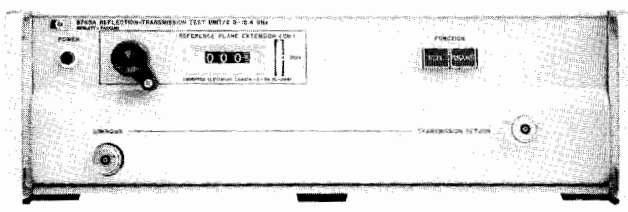

8743A

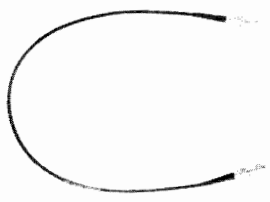

11610B

8743A Reflection/Transmission Test Unit

Function: wideband RF power splitter and reflectometer with calibrated line stretcher. Pushbutton operated for either transmission or reflection measurement with network analyzer.

Frequency range: 2 to 12.4 GHz, (Opt 018: 2 to 18 GHz).

Impedance: 50 ohms nominal.

Source reflection coefficient: ≤ 0.09 , 2.0 to 8.0 GHz; ≤ 0.13 , 8.0 to 12.4 GHz; < 0.2 , 12.4 to 18 GHz.

Termination reflection coefficient: ≤ 0.13 in reflection mode, 2.0 to 12.4 GHz; ≤ 0.2 in transmission mode, 2.0 to 12.4 GHz; typically < 0.2 , 12.4 to 18 GHz.

Directivity: ≥ 30 dB, 2.0 to 12.4 GHz; ≥ 18 dB, 12.4 to 18 GHz.

Reference plane extension: 0 to 15 cm for reflection; 0 to 30 cm for transmission.

Connectors: RF input, type N female; all other connectors APC-7.

Remote programming: ground closure.

Power: 115 or 230 V $\pm 10\%$, 50-400 Hz, 15 W.

Weight: net, 12.1 kg (29 lb). Shipping, 15.3 kg (34 lb).

Size: 140 H x 425 W x 467 mm D (5.50" x 16.75" x 18.38").

11610B Test Port Extension Cable

Function: A high quality semirigid coaxial cable used with the 8409B Automatic Network Analyzer at frequencies up to 18 GHz. It is designed for applications which require excellent magnitude and phase repeatability from connection to connection. The cable exhibits minimum change in transmission characteristics when flexed during normal use.

Frequency range: dc to 18 GHz.

Impedance: 50 ohms nominal. Reflection coefficient of ports < 0.14 .

Insertion loss: < 0.7 dB + 0.12 db/GHz.

Stability with three repeated flexings: < 0.3 dB, < 0.5 degrees 0.12 degrees/GHz change.

Connectors: APC-7.

Length: 107 cm (42 inches)

8410S Opt 210 Specifications

Function: The 8410S Option 210 measurement system configuration is described on page 509. Following are specifications describing measurement capabilities of the 8410B/8411A when used with the 8743B/11610B over the frequency range of 2 GHz to 12.4 GHz.

Frequency range: 2.0 to 12.4 GHz.

RF input: 20 dB range between +12 dBm and -5 dBm.

Source reflection coefficient: ≤ 0.09 , 2-8 GHz; ≤ 0.13 , 8-12.4 GHz.

Termination reflection coefficient: ≤ 0.09 , 2-8 GHz; ≤ 0.13 , 8-12.4 GHz.

Directivity: ≥ 30 dB, 2-12.4 GHz.

Insertion loss, RF input to test port: 20 dB nominal.

Frequency Response

Transmission: typically $< \pm 0.5$ dB amplitude and $< \pm 5^\circ$ phase.

Reflection: typically $< \pm 0.09$ magnitude and $< \pm 6^\circ$ phase, with a short on the unknown port.

Transmission measurement accuracy: (see Common Performance Specifications).

Reflection measurement accuracy (using 8414A): sources of error included in the accuracy equations are directivity, source match, and polar display accuracy.

Magnitude accuracy:

$$\rho_u = \pm (0.0316 + 0.03 \rho_L + 0.09 \rho_L^2) \text{ 2-8 GHz.}$$

$$\rho_u = \pm (0.0316 + 0.03 \rho_L + 0.13 \rho_L^2) \text{ 8-12.4 GHz.}$$

ρ_u = magnitude uncertainty.

ρ_L = measured reflection coefficient magnitude.

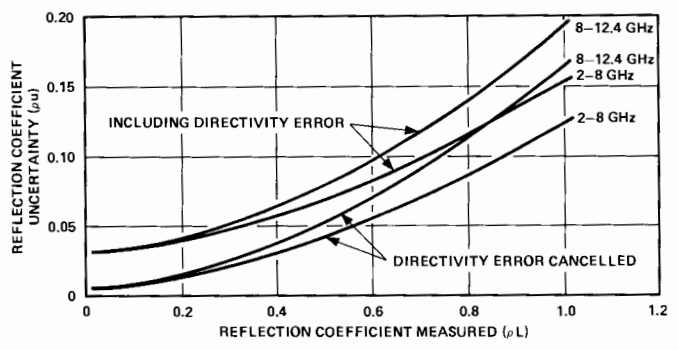

Phase accuracy:

$$\Phi_u = \sin^{-1} \rho_u / \rho_L \text{ for } \Phi_u < \pm 90^\circ.$$

Φ_u = phase uncertainty.

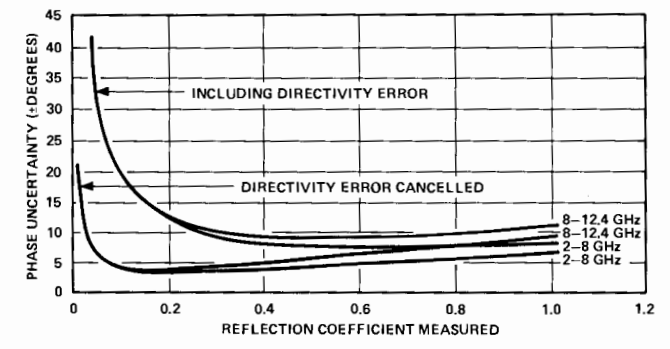

See 8410S Network Analyzer Systems Table for price and instrument breakdown.

8743A Reflection/Transmission Test Unit	\$5000
Opt 018: 2 to 18 GHz	add \$800
Opt 908: Rack Flange Kit	add \$22
11605A Flexible Arm	\$1525
Opt 018: 0.11 to 18 GHz	add \$575
11610B Test Port Extension Cable	\$650

NETWORK ANALYZERS

Test Sets and Accessories (Cont.)

8410 Family

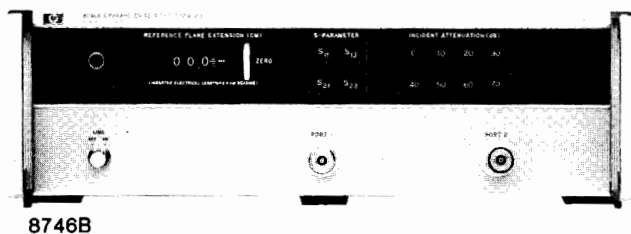

8746B



11608A

8746B S-Parameter Test Set

Function: wideband RF power divider and reflectometer with calibrated stretcher and a selectable 0-70 dB incident signal attenuator. Provides internal bias for completely characterizing two port active devices.

Frequency range: 0.5 to 12.4 GHz.

Source and termination reflection coefficient: ≤ 0.13 .

Directivity: ≥ 30 dB, 0.5 to 4.0 GHz; ≥ 26 dB, 4.0 to 12.4 GHz.

Incident attenuation: 0-70 dB in 10 dB steps $\pm 5\%$.

Reference plane extension: adds 0 to 15 cm for reflection; 0 to 30 cm for transmission.

Remote programming: ground closure.

Transistor biasing: via 36 Pin connector.

Connectors: input type N female, test ports APC-7.

Opt 001: provides 10 dB higher power level at the test port.

Power: 115 or 230 V $\pm 10\%$, 48 to 440 Hz, 110 VA max.

Weight: net, 16.1 kg (35 lb). Shipping, 19.1 kg (42 lb).

Size: 140 H x 425 W x 467 mm D (5.5" x 16.75" x 18.38").

11608A Transistor Fixture

Function: provides the capability of completely characterizing stripline transistors. A through-line microstrip and bolt-in grounding structure machineable by customer is available.

Frequency range: dc to 12.4 GHz.

Reflection coefficient: < 0.05 , dc to 4 GHz; < 0.07 , 4.0 to 8.0 GHz; < 0.11 , 8 to 12.4 GHz.

Package styles

Opt 003: 0.205 inch diameter packages.

Calibration references: options 002 and 003 only, short circuit termination and a 50-ohm through-section.

Connectors: APC-7 Hybrid.

Weight: net, 0.9 kg (2 lb). Shipping, 1.4 kg (3 lb).

Size: 25 H x 143 W x 89 mm D (1" x 5.63" x 3.5").

8410S Opt 500 Specifications

Function: The 8410S option 500 measurement system configuration is described on page 509. Following are specifications describing measurement capabilities of the 8410B/8411A when used with the 8746B/11608A over the frequency range of 500 MHz to 12.4 GHz.

Frequency range: 0.5 to 12.4 GHz.

Transistor dc bias selection; front panel slide switches establish proper dc biasing for both Bi-polar and FET transistors. The voltage and current controls operation independently and are continuously adjustable over a current range of 0 to 500 mA and a range of 0 to 30 Vdc.

RF input: 20 dB range between +12 and -5 dBm.

Incident attenuation range: 0 to 70 dB in 10 dB steps.

Source reflection coefficient: (typically) ≤ 0.132 , 0.5 to 4.0 GHz; ≤ 0.135 , 4.0 to 8.0 GHz; ± 0.141 , 8.0 to 12.4 GHz.

Termination reflection coefficient: (typically) < 0.139 , 0.5 to 4.0 GHz; < 0.148 , 4.0 to 8.0 GHz; GHz; ± 0.170 , 8.0 to 12.4 GHz.

Directivity: ≥ 28 dB, 0.5 to 4.0 GHz; ≥ 24 dB, 4 to 8.0 GHz; ≥ 23 dB, 8.0 to 12.4 GHz.

Frequency response: (typically) < 0.5 dB, ± 7 degrees, 0.05 to 4.0 GHz; < 0.75 dB, ± 7 degrees, 4.0 to 8.0 GHz; < 1.25 dB, ± 7 degrees, 8.0 to 12.4 GHz.

Transmission measurement accuracy: (see Common Performance Specifications).

Reflection measurement accuracy: sources of error included in the accuracy equation are directivity and source match.

Magnitude accuracy:

$\rho_u = \pm (0.04 + 0.08 \rho_L + 0.13 \rho_L^2)$ 0.5 to 4.0 GHz.

$\rho_u = \pm (0.06 + 0.09 \rho_L + 0.135 \rho_L^2)$ 4.0 to 8.0 GHz.

$\rho_u = \pm (0.074 + 0.098 \rho_L + 0.14 \rho_L^2)$ 8.0 to 12.4 GHz.

ρ_u = magnitude uncertainty.

ρ_L = measured reflection coefficient magnitude.

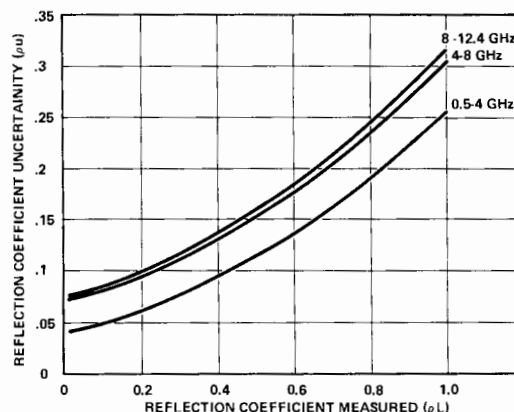

Phase accuracy:

$\Phi_u = \sin^{-1} \rho_u / \rho_L$ for $\Phi_u < 90^\circ$.

Φ_u = phase uncertainty.

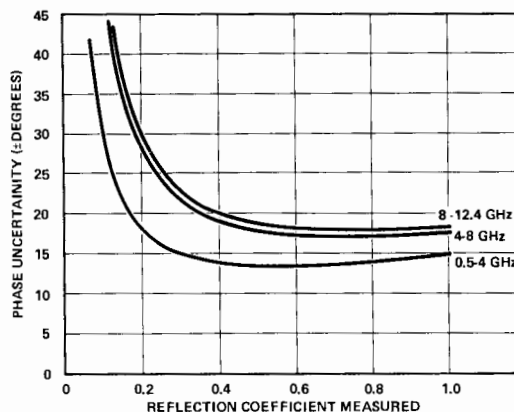

See 8410S Network Analyzer Systems Table for price and instrument breakdown.

Ordering Information

8746B Test Unit

Opt 001: Large Signal

Opt 908: Rack Flange Kit

11608A Transistor Fixture Customer Machineable

Opt 003: 0.205 inch diameter package style

Price

\$10,300

N/C

add \$25

\$850

add \$75



8717B

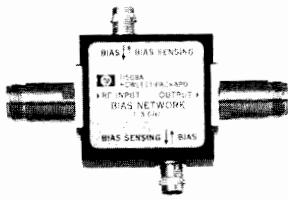

11589A and 11590A

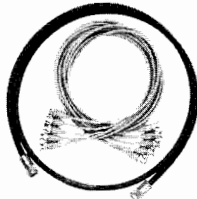

11609A



11650A

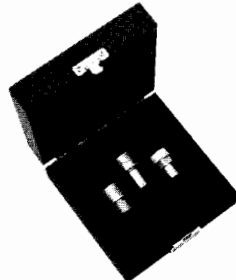

11866A

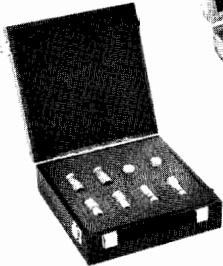

85032A

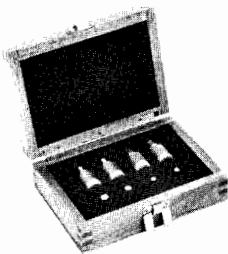

85033A

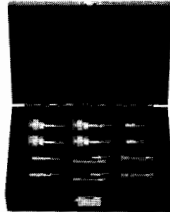

85033B

8717B Transistor Bias Supply

Function: for manual or programmable transistor testing. It is particularly useful with the 11600B, 11602B, and 11608A Transistor Fixtures. The 8717B has two meters for independently monitoring current and voltage on any of the three leads of a transistor under test. Bias connections are conveniently selected for all transistor configurations with a front panel switch. Special circuitry protects sensitive devices from excessive current transients which commonly occur in less sophisticated supplies.

Voltage ranges: 1, 3, 10, 30, 100 V.

Current ranges: 0.1, 0.3, 1, 3, 10, 30, 100, 300, 1000 mA.

Accuracy: 4% of full scale for both current and voltage.

Option 001: programmable D/A converter.

Weight: net, 9.0 kg (20 lb). Shipping, 11.0 kg (25 lb).

Size: 86 H x 425 W x 336 mm D (3.38" x 16.75" x 13.5").

11589A and 11590A Bias Networks

Function: auxiliary units for use with the 11600B, 11602B and 11608A transistor fixtures. These bias networks provide dc bias to the center conductor of a coaxial line while blocking the dc bias from the input RF circuit.

Frequency range: 11589A—0.1 to 3.0 GHz; 11590A—1.0 to 12.4 GHz.

Connectors: BNC for dc biasing; type N female for RF (Option 001; APC-7).

Weight: net, 0.3 kg (0.67 lb). Shipping, 0.5 kg (1 lb).

Size: 29 H x 76 W x 114 mm D (1.38" x 3" x 4.5").

11650A Accessory Kit

Function: accessories normally used for transmission and reflection tests with the 8745A and 8743A.

Weight: net, 1.34 kg (3 lb). Shipping, 2.23 kg (5 lb).

11609A Cable Kit

Function: interconnecting cables normally required for network measurements using the 8410 network analyzer.

Weight: net, 0.9 kg (2 lb). Shipping, 1.36 kg (3 lb).

11866A APC-7 Calibration Kit

Function: a 50Ω (>52 dB return loss @ 2 GHz) termination, a short circuit and a shielded open circuit are used with the 8409 to quantify directivity, source match, and frequency tracking errors.

Weight: net 0.57 kg (1.25 lb). Shipping 0.91 kg. (2.0 lb).

Size: 50.8 H x 7 W x 12.7 D (2.0" x 5.0" x 5.0").

85032A Type N Calibration Kit

Function: provides two Type N male to APC-7 adapters, two Type N female to APC-7 adapters, as well as one each Type N male and female short circuits and 50Ω (<1.01 SWR at 2 GHz) terminations. Option 001 adds one each male and female Type N shielded open circuits.

85033A SMA Calibration Kit

Function: provides two SMA male to APC-7 adapters, two SMA female to APC-7 adapters, as well as one each SMA male and female short circuits and 50Ω (<1.06 SWR at 1 GHz) terminations. Option 001 adds one each SMA male and female shielded open circuits.

85033B APC-3.5 Calibration Kit

Function: provides two APC-3.5 male to APC-7 adapters, two APC-3.5 female to APC-7 adapters, as well as one each APC-3.5 male and female short circuits shielded open circuits with center pin extenders, and 50Ω (<1.03 SWR at 2 GHz) terminations. This kit is specially designed for use with 8409-series Automatic Network Analyzer systems.

Ordering Information

	Price
8717B Transistor Bias Supply	\$3400
Opt 001: Programmable D/A Converter	add \$670
Opt 908: Rack Flange Kit	add \$25
11589A Bias Network	\$400
Opt 001: APC-7 Connectors	add \$30
11590A Bias Network	\$450
Opt 001: APC-7 Connectors	add \$30
11650A Accessory Kit	\$1055
11609A Cable Kit	\$145
11866A APC-7 Calibration Kit	\$360
85032A N Calibration Kit	\$775
Opt 001: Shielded Open Circuits	\$300
85033A SMA Calibration Kit	\$650
Opt 001: Shielded Open Circuits	\$100
85033B APC-3.5 Calibration Kit	\$1950

NETWORK ANALYZERS

Accessories, Waveguide Test Sets, 8410S Systems

8410 Family

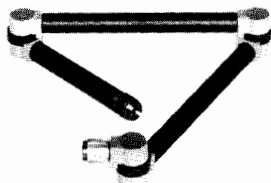

11605A



11857A

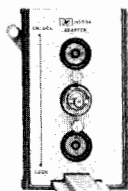

11599A

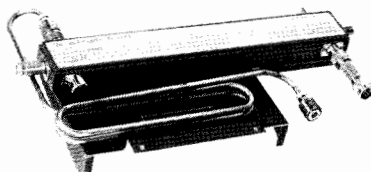

11607A



8413A

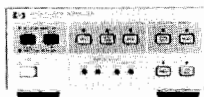

8750A

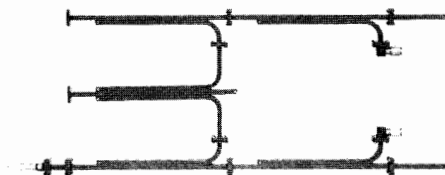

X8747A and P8747A

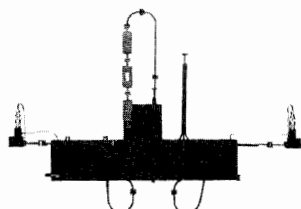

K8747A and R8747A

11605A Flexible Arm

Function: Mounts on front of 8743A; connects to device under test. Rotary air-lines and rotary joints connect to any two-port geometry.

Frequency range: dc to 12.4 GHz. (Opt 018, 2 to 18 GHz).

Impedance: 50 ohms nominal. Reflection coefficient of ports: ≤ 0.11 , dc to 12.4.

Opt 018: ≤ 0.23 , 2.0 to 12.4 GHz; ≤ 0.31 , 12.4 to 18 GHz.

Connectors: APC-7.

Weight: net, 1.8 kg (4 lb). Shipping, 2.7 kg (6 lb).

Length: 257 mm (10.09") closed; 648 mm (25.50") extended.

11857A 50 Ohm APC-7 Test Port Extension Cables

General: two precision 61 cm (24 in.) cables, for use with 8745A S-parameter test set. Connectors are 50 Ohm APC-7.

Weight: net, 0.91 kg (2 lb). Shipping, 2.3 kg (5 lb).

11599A Quick Connect Adapter

Function: quickly connects and disconnects the 8745A and the transistor fixtures or 11604A universal extension.

Weight: net, 0.4 kg (0.88 lb). Shipping, 0.9 kg (2 lb).

Size: 127 H x 76 W x 108 mm D (5" x 3" x 4.5").

11607A Small Signal Adapter

Function: used with the 8745A S-parameter test set. The incident signal levels to the test device are reduced to the -20 to -40 dBm range.

Weight: net 4.1 kg (4.63 lb). Shipping, 4.5 kg (10 lb).

Size: 60 H x 413 W x 244 mm D (2.38" x 16.25" x 9.63").

8413A Phase-Gain Indicator

Function: plug-in meter display unit for 8410B. Displays relative amplitude in dB or relative phase in degrees between reference and test channel inputs. Pushbutton selection of meter function and range.

Amplitude

Range: ± 30 , ± 10 , and ± 3 dB full scale.

Accuracy: $\pm 3\%$ of end scale.

Log output: 50 millivolts per dB up to 60 dB total.

Phase

Range: ± 180 , ± 60 , ± 6 degrees full scale.

Accuracy: $\pm 2\%$ of end scale.

Output: 10 millivolts per degree.

Phase offset: ± 180 degrees in 10-degree steps.

Accuracy: $\pm 0.2^\circ + 0.3^\circ/10^\circ$ step, cumulative $< 2^\circ$.

Power: 15 watts supplied by mainframe.

Weight: net, 4.9 kg (11 lb). Shipping, 6.7 kg (15 lb).

Size: 152 H x 186 W x 395 mm D (6" x 7.28" x 15.56").

X, P 8747A Reflection/Transmission Test Units

Function: waveguide setup for measuring reflection and transmission parameters of waveguide devices with the network analyzer.

Frequency range: X8747A: 8.2-12.4 GHz; P8747A: 12.4-18 GHz.

K, R 8747A Reflection/Transmission Test Units

Function: waveguide setup for measuring reflection and transmission parameters of waveguide devices with the network analyzer; down-converts with built-in mixers to the frequency range of the 8411A.

Frequency range: K8747A: 18-26.5 GHz; R8747A: 26.5-40 GHz.

8750A Storage-Normalizer

General: the 8750A Storage-Normalizer provides digitally stored and normalized CRT displays when used with the 8412A Phase Magnitude Display. Measurements are faster, easier and more accurate when the 8750A is employed because the CRT is flicker-free and frequency response errors are eliminated. The 8750A is not compatible with the 8414A Polar Display. Option 003 adds 8412A Compatibility.

Detailed specifications on page 501.

Ordering Information

Part Number	Description	Price
11605A	Flexible Arm	\$1525
Opt 018:	0.11 to 18 GHz	add \$575
11857A	50 Ohm APC-7 Test Port Extension Cables	\$650
8413A	Phase-Gain Display	\$2100
11599A	Quick Connect Adapter	\$200
11607A	Small Signal Adapter	\$850
8750A	Storage-Normalizer	\$1750
Opt 003:	8412A Plug-In Interface Card	\$100
X8747A	Waveguide Test Set	\$3475
P8747A	Waveguide Test Set	\$3625
K8747A	Waveguide Test Set	\$10,025
R8747A	Waveguide Test Set	\$10,575

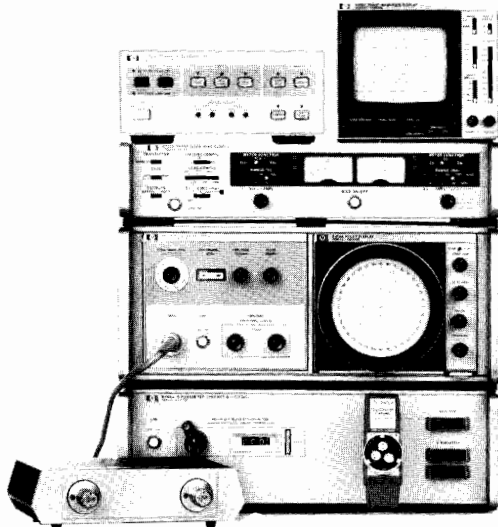

8410S Opt 400

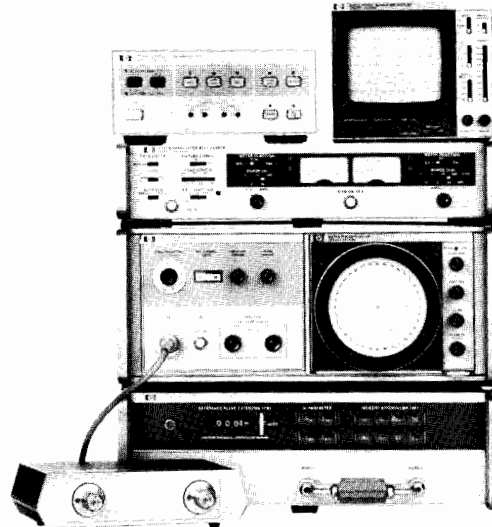

8410S Opt 500

8410S systems enable ordering a complete network analyzer system, except for source, using a single model number. Each option has been configured for making general measurements on coaxial or semiconductor devices. The 8410S Systems enable the operator to view a real time CRT display over octave or multioctave bands with a dynamic range of 60 dB amplitude and 360° phase. Multioctave, continuous network measurements over the frequency range of 2 to 18

GHz are possible when the 8410B is used with the HP 8620C or 8350A Sweep Oscillator.

The 8410S Systems' upper frequency limit for coaxial and semiconductor measurements is 12.4 GHz; however, individual instruments may be ordered that will expand coaxial measurement capability to 18 GHz (option 018 instruments) and waveguide measurements from 8.2 GHz to 40 GHz (8747A series).

8410S Network Analyzer Systems Table

GENERAL PURPOSE MEASUREMENTS			All 8410S Systems Include the Following Instrument Model Numbers: 8410B, 8411A, 8412A, 8414A, 11609A, and 8750A opt. 003										
Frequency Range	Option No.	Measurement Port Configuration	8743B	8745A	8746A	8717B	11600B	11602B	11608A	11604A	11610B	11650A	Price
0.11 to 2 GHz	110	Coaxial (APC-7)		X						X		X	\$29,770
0.11 to 12.4 GHz	310	Coaxial (APC-7)	X	X						X	X	X	\$36,770
2 to 12.4 GHz	210	Coaxial (APC-7)	X								X	X	\$27,270
SEMICONDUCTOR CHARACTERIZATION													
0.11 to 2 GHz	400	T018/T072 Packages		X		X	X						\$30,845
0.11 to 2 GHz	401	T05/T012 Packages		X		X		X					\$30,845
0.5 to 12.4 GHz	500	Stripline			X	X			X				\$33,795

NETWORK ANALYZERS

Automatic Network Analyzer, 500 MHz to 18 GHz
Model 8408A

- 40 dB Effective Directivity
- Economical reflection and transmission measurements
- 8-term vector error-correction
- Friendly, easy-to-use

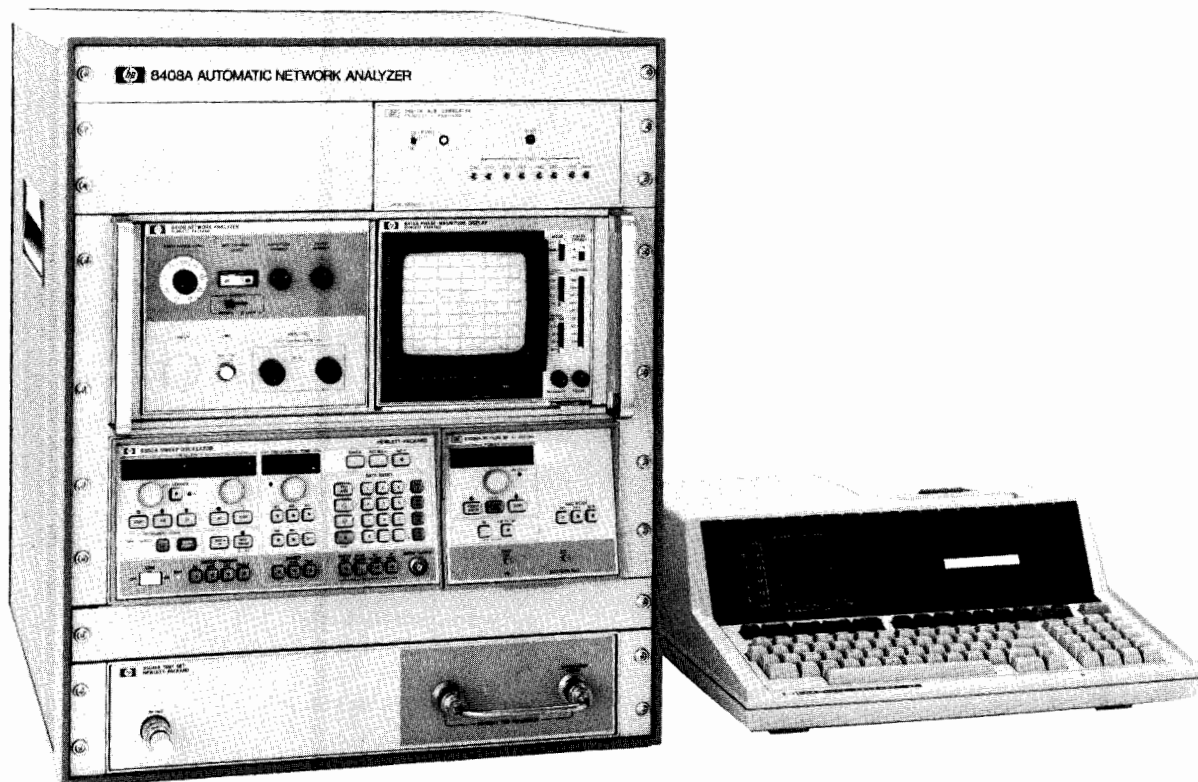

Description

The HP 8408A Automatic Network Analyzer is a complete microwave network measurement system composed of a network analyzer (receiver), reflection/transmission test set, programmable source, computing controller, and accuracy enhancement pac for making vector error-corrected measurements. The HP 8408A system is fully assembled and integrated at the factory. All accessories and cables necessary for making transmission and reflection measurements are supplied with the system, including calibration standards for measurements in APC-7.

Utilizing a single broadband source and test set, the HP 8408A system measures return loss and transmission (magnitude and phase) over the 500 MHz to 18 GHz frequency range. To verify that the proper connections have been made or to adjust the test device, a real-time CRT display of swept magnitude and phase is provided over the selected frequency range. The test set is designed for either reflection or transmission measurements. When switching between reflection and transmission measurements, the user simply changes a single coaxial connection on the test set.

The HP 8408A is a tuned receiver that allows both magnitude and phase information of the test signal to be obtained. In comparison to a magnitude-only (scalar) measurement system, a tuned receiver provides a 60 dB measurement range that is immune to measurement ambiguities caused by source harmonics or spurious signals. Using phase information, system errors like directivity and source match can be measured and effectively removed. Hence magnitude measurements can be made with much greater accuracy than in scalar systems.

The HP 8408A makes vector error-corrected measurements by initially measuring several calibration standards in order to quantify and store the repeatable system errors. Then at each measurement frequency the measured data is enhanced by using an 8-term error correction model that effectively removes these system errors. By using vector error-correction and the appropriate calibration standards, the effective system directivity is better than 40 dB at the measurement test port using the desired test connector type.

The Accuracy Enhancement Pac provided with the system allows the user to immediately make measurements at up to 100 frequencies. The software guides the user via simple prompts through the initial setup, calibration, measurement, and output sequences in order to simplify system operation. After measuring the test device, the data can be displayed in a tabular listing, plotted versus frequency in a rectangular format, or plotted in a polar format. Direct the output to the CRT or the internal thermal printer for hard copy results. When plotting, you even have the option of selecting the scale values or letting the software automatically scale the data for you.

For measurements in APC-3.5 or Type-N, the proper calibration standards and adapters are available. For APC-3.5, use the 85033B Calibration Kit and 911C Sliding Load. For Type-N, use the 85032A Option 001 Calibration Kit. The sliding load provided with the system can be used for APC-7 and Type-N.

Ordering Information

	Price
8408A Automatic Network Analyzer (0.5 to 18 GHz)	\$60,000
Opt 001: 2 to 18 GHz Coverage only	less \$4,250
(substitute 83590A for 83592A)	
Opt 002: Delete HP 85 Controller System	less \$4,570
Opt 003: Delete Sweep Oscillator Plug-in	less \$23,650

NETWORK ANALYZERS

Automatic Network Analyzer, 110 MHz to 18 GHz

Model 8409C



- Synthesized network analyzer with phase-locked source
- Full S-Parameter and group delay measurement capability
- High performance calibration/metrology system
- 12-term vector error-correction

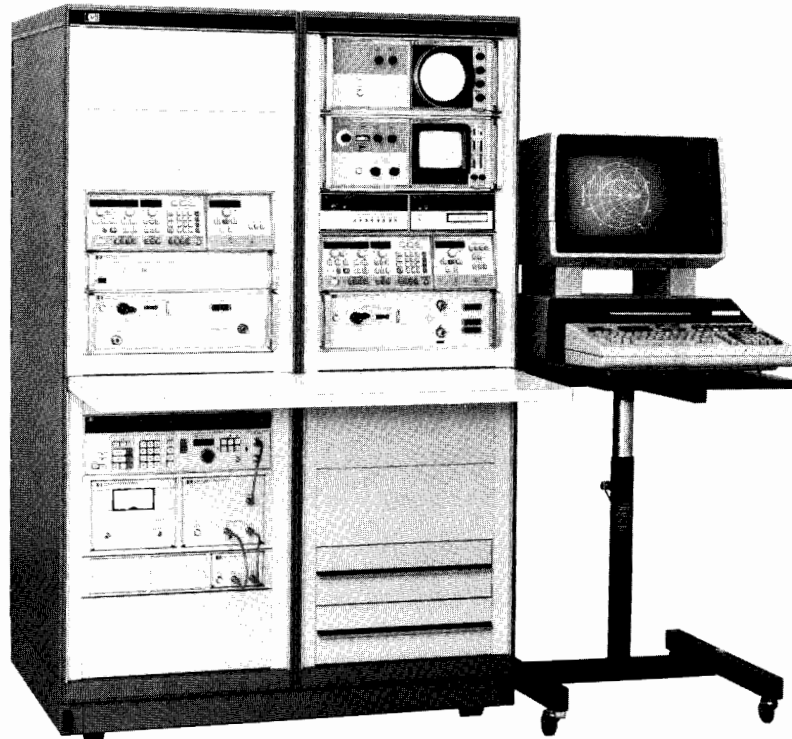

Description

The HP 8409C Automatic Network Analyzer is a complete, high performance microwave network measurement system for high accuracy, vector error-corrected S-Parameter and Group Delay measurements. The system includes a synthesized network analyzer, phase-locked source, S-Parameter test set, desktop computer, and software using a comprehensive vector error-correction model. The 8409C is ideal for calibration requirements and difficult to measure devices that have either very low or high input reflection coefficients, such as cables and transistors. All accessories are provided for vector error-corrected measurements in APC-7, APC-3.5, and Type N.

The Phase-lock subsystem provides a synthesized receiver for improved measurement accuracy and a synthesizer class phase-locked source for high resolution frequency control. For best measurement accuracy and dynamic range, phase and low level magnitude information is taken from a polar display, with a phase-magnitude display used for all other information. The vector error-correction model used in the 8409C is user selectable between the simple 8-term model and a more comprehensive 12-term model. This allows flexibility in making tradeoffs between measurement accuracy and speed depending on unique measurement requirements.

System Configurations

The standard 8409C system is a two bay rack that covers the 110 MHz to 18 GHz frequency range in two bands: 110 MHz to 2 GHz, and 2 to 18 GHz, with the appropriate source and test set outputs automatically switched to the network analyzer. The system is controlled by a 9845B Desktop Computer that uses the 11863F Accuracy Enhancement Pac, a BASIC language program. Also available is the 9826A Desktop Computer and its associated 11863E Accuracy Enhancement Pac (an HPL program that provides the same measurement capability as the 11863F software).

For narrower frequency coverage, select either 2 to 18 GHz, or 500 MHz to 12.4 GHz, coverage. These single bay rack versions utilize a single source and test set combination. For active device measurements over the 500 MHz to 12.4 GHz frequency range, two configurations include a programmable bias supply (8717B) with the proper

control hardware for use with either the 9845B or the 9826A Desktop Computer. For less demanding applications, the phase-lock subsystem can be deleted in any 8409C configuration.

Ordering Information

	Price
8409C Automatic Network Analyzer (110 MHz to 18 GHz)	\$149,000
Option 100: Delete Phase-lock subsystem from standard 8409C (0.11-18 GHz)	less \$14,600

Frequency range/phase-lock options: (select one only)

2 to 18 GHz Operation Only:	
Option 001: With phase-lock subsystem	less \$29,000
Option 101: Without phase-lock subsystem	less \$44,000
500 MHz to 12.4 GHz Operation Only (no bias supply):	
Option 010: With phase-lock subsystem	less \$19,700
Option 110: Without phase-lock subsystem	less \$35,500
500 MHz to 12.4 GHz Operation with programmable bias supply for use with the 9845B:	
Option 011: With phase-lock subsystem	less \$14,200
Option 111: Without phase-lock subsystem	less \$30,000
500 MHz to 12.4 GHz Operation with programmable bias supply for use with 9826A:	
Option 012: With phase-lock subsystem	less \$14,200
Option 112: Without phase-lock subsystem	less \$30,000

System controller options: (select one only)

Option 002: Delete 9845B Controller system and 11863F Software	less \$29,740
Option 003: Substitute 9826A Controller system and 11863E HPL Software for 9845B/11863F BASIC language system	less \$18,405

230 Volt line operation options: (select one only)

Option 230: For standard 8409C (0.11-18 GHz) system (two bay rack version)	N/C
Option 231: For all optional 8409C frequency ranges (single bay rack versions)	N/C

SIGNAL ANALYZERS

Wave, Distortion, Modulation, Spectrum and Fourier Analyzers

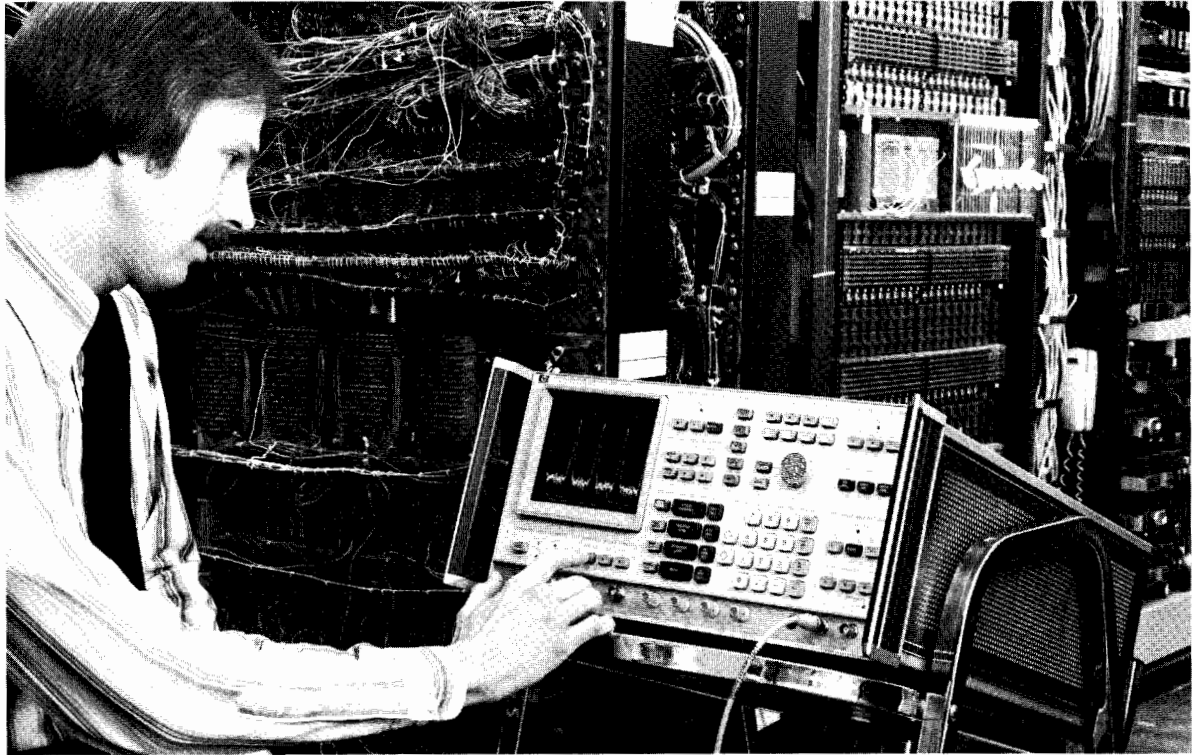

Analysis of signals in the frequency domain is an important measurement concept which is widely used for providing electrical and physical system performance information. Several examples will illustrate some important applications where signal analyzers are useful.

Mechanical Measurements

Noise and vibration levels are of major concern to manufacturers and users of mechanical structures such as aircraft, automobiles, and bridges. With an appropriate motion-to-electrical signal transducer the spectrum analyzer or the Fourier analyzer can examine vibration signals in the frequency domain. This makes it possible to monitor and analyze vibration components of rotating machines associated with unbalance, worn bearings or worn gears, and to identify a structure's natural modes of vibration.

Communications

In the fields of telecommunications, the spectrum, modulation, wave and audio analyzers provide vital operational performance verification of transceivers and multiplex systems. Unwanted signals such as carrier leak signals, out-of-band noise, and cross modulated signals must be identified. System gain, loss, distortion and pilot tone measurements must also be made. These measurements are discussed in more detail in the Telecommunications Test Equipment section of this catalog.

Electronic Testing

Finally, in the general field of electronics, there are four primary uses for the signal analyzer. First, the analyzer is used to identify and measure signals which result from non-linear effects in the process of amplification, filtering, and mixing. Second, the purity of signal sources is commonly observed.

Third, the modulation analyzer serves a special purpose in analyzing modulated communication signals by measuring and displaying RF power, frequency and modulation characteristics. Fourth, the signal analyzer with a companion tracking generator is used as a network analyzer for frequency response measurements of filters, amplifiers, and many other types of networks.

Basic Analyzers

This section discusses the definition and use of several types of instruments for frequency response signal analysis: spectrum analyzers, digital Fourier analyzers, wave analyzers, distortion analyzers, audio analyzers and modulation analyzers.

Each of these instruments measure basic properties of a signal in the frequency domain, but each uses a different technique. The spectrum analyzer is a swept receiver that provides a visual display of amplitude versus frequency. It shows on a single display how energy is distributed as a function of frequency, displaying the absolute value of Fourier components of a given waveform. The Fourier analyzer uses digital sampling and transformation techniques to form a Fourier spectrum display that has phase as well as amplitude information. The wave analyzer is the true tuned voltmeter, showing on a meter the amplitude of the energy in a specific frequency window which is tunable over a specific frequency range. The distortion analyzer performs an almost reciprocal function to that of the wave analyzer. It collectively measures the energy outside a specific bandwidth tuning out the fundamental signal and displaying the energy of the harmonics and other distortion products on a meter. The Audio Analyzer performs the same measurement function as a distortion analyzer but also includes the additional

measurement functions of SINAD, signal to noise ratio, frequency count, true rms dvm and dc dvm. The modulation analyzer tunes to the desired signal and recovers the entire modulation envelope of AM, FM and phase modulation for processing and display.

Different Views

Figure 1 shows a graphical representation of the way four of the analyzers view a signal and one harmonic. The time domain scan of the signal is presented in Figure 1a. $A(t)$ is the complex voltage waveform as it would be viewed on an oscilloscope. The dashed lines represent the vector components of the signal: $A_1(t)$, the fundamental and $A_2(t)$ the second harmonic. In 1b, the spectrum analyzer displays the frequency spectrum showing both vector components and their amplitude relationship. Spectrum analysis is useful from 5 Hz to over 40 GHz.

The Fourier analyzer uses digital signal processing techniques to extract both the amplitude and phase information about each spectral component. Conceptually the Fourier analyzer can be viewed as measuring a large number (up to 2048) of parallel filters as shown in Figure 1c. These filters are actually very specialized digital filters so that precise, repeatable results can be obtained. With this arrangement of parallel filters the complete display is generated in the time that it takes to analyze the lowest frequency component. HP Fourier analyzers presently cover the range of DC to 100 kHz.

The wave analyzer in Figure 1d, measures the amplitude and frequency of the signal in the frequency window to which it is tuned. This window can be moved to measure the amplitude of the second harmonic, thereby making a precise comparison with the fundamental. This technique is practical from 15 Hz to above 32 MHz.

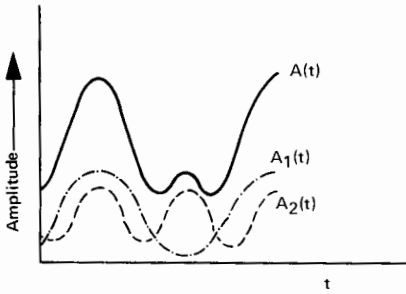

Figure 1a. Waveform

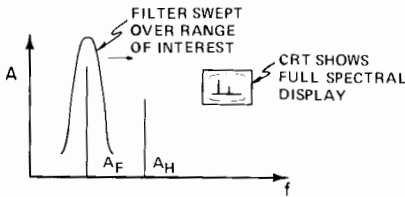

Figure 1b. Spectrum analyzer

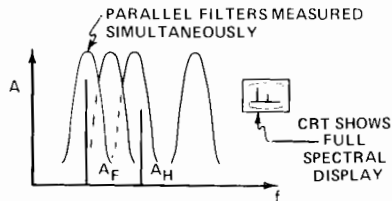

Figure 1c. Fourier analyzer

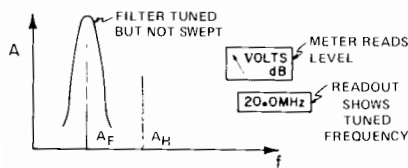

Figure 1d. Wave analyzer

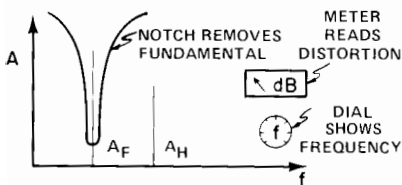

Figure 1e. Distortion analyzer

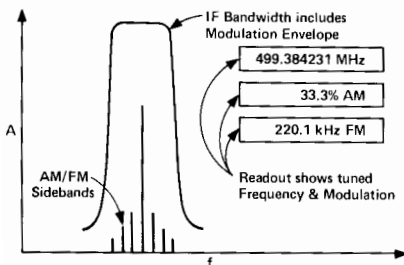

Figure 1f. Modulation analyzer

The distortion analyzer as pictured in Figure 1e. rejects the fundamental to which it has been tuned and measures the energy everywhere else within the instrument's frequency spectrum. Distortion, as a percentage or in dB down from the fundamental, is displayed directly on a meter. Hewlett-Packard distortion analyzers cover 5 Hz to 600 kHz.

The modulation analyzer of Figure 1f tunes to a desired frequency just as the wave analyzer. Its IF bandwidth and detection system are designed to pass the entire modulation envelope so that percent modulation, distortion, residual and peak deviation measurements can be made. All close-in spectral components, of course, are combined in the measurement.

The following section considers each instrument technique, showing the particular strength and flexibility of each.

Spectrum Analyzers

To display useful information about a frequency scan, a spectrum analyzer must be sensitive, frequency stable, free of spurious responses over a wide band, and have calibrated accuracy in the CRT display. The examples which follow best demonstrate the wide variety of information which can be measured on the spectrum analyzer.

Measurements with the Spectrum Analyzer

CW signal: the most basic spectrum analysis measurement is the single CW signal.

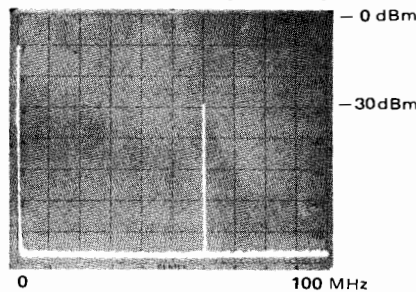

Pictured is a -30 dBm signal at 60 MHz. The zero frequency indicator is at the far left graticule.

Spectral purity of a CW signal: one very important oscillator signal measurement is spectral purity. This 70 MHz carrier has power line related sidebands (± 60 Hz) which are 65 dB down.

Such sidebands may result from power supply ripple. The 50 Hz/division spectrum analyzer scan and the 10 Hz analyzer bandwidth provide the high degree of resolution required to see these sidebands.

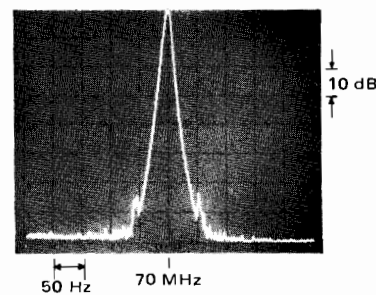

Frequency conversion products: the spectrum analyzer is well suited for frequency conversion measurements such as the output of a balanced mixer as shown.

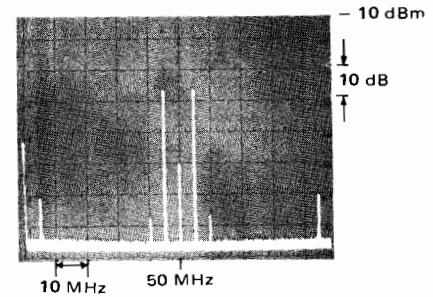

With the 50 MHz local oscillator input at 0 dBm and a 5 MHz, -30 dBm mixer signal, two sidebands at 45 MHz and 55 MHz result. The sidebands are -36 dBm, giving the mixer a 6 dB conversion loss. The local oscillator has 60 dB isolation and the 5 MHz signal has 41 dB isolation. Second order distortion products at 40 and 60 MHz are 40 dB below the desired mixer outputs.

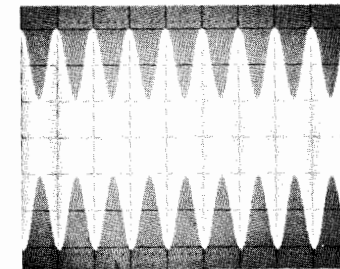

Oscilloscope

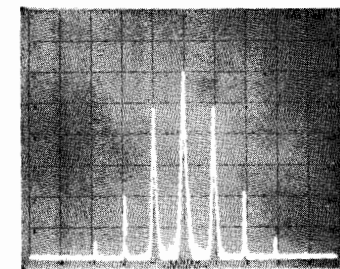

Spectrum Analyzer

Amplitude modulation: percent amplitude modulation is often more easily measured with the spectrum analyzer than it is with the oscilloscope. This is especially true for low level modulation.

With the oscilloscope time display, percent modulation, M , is measured as a ratio of the signal's dimensions: $M = 100(6-2)/(6+2) = 50\%$. In the spectrum analyzer display, whose vertical calibration is 10 dB/division, the carrier and sidebands differ by 12 dB, the voltages in the sidebands are $1/4$ of that of the carrier and again, $M = 50\%$. At the same time the second and third harmonic distortion of the sidebands can be measured at 28 and 44 dB respectively.

SIGNAL ANALYZERS

Wave, Distortion, Modulation, Spectrum and Fourier Analyzers (Cont'd)

Frequency modulation: information transmitted by FM can be characterized by the spectrum analyzer.

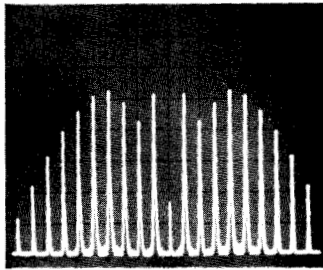

Low Deviation FM

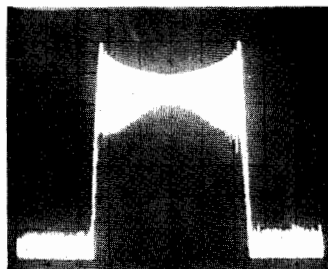

High Deviation FM

Low deviation FM is applied to a 60 MHz carrier in the first photo. The deviation has been adjusted for the second carrier null ($M = 5.52$). The sideband spacing is 10 kHz, the modulation frequency; therefore, $\Delta f_{\text{peak}} = 5.52 \times 10 \text{ kHz} = 55.2 \text{ kHz}$.

The second photo is an example of a high deviation FM. The transmission bandwidth is 2.5 MHz.

Pulsed CW power: by viewing the spectra of a repetitive RF pulse on the spectrum analyzer, pulse width, average and peak power, occupied bandwidth, and duty cycle can be determined.

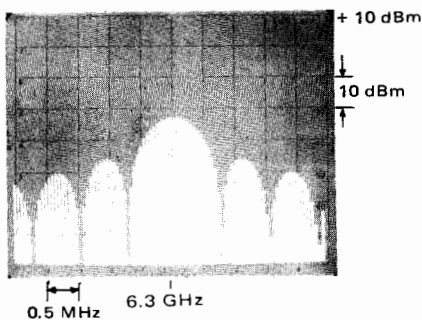

From the spectral output shown the pulse's complete characteristics are determined: 6.3 GHz RF at 0 dBm, pulsed at 50 kHz rate. The pulse width is 1.3 μs .

Noise: spectrum analysis is effective in measuring impulse noise, random noise, carrier to noise ratio, and amplifier noise figure.

Phase noise: the short term frequency fluctuations of a sine wave source can be measured directly as phase modulation sidebands. Hewlett-Packard spectrum analyzers with narrow resolution and synthesized internal frequency sources can make many phase noise measurements directly. Bandwidth corrections, analyzer corrections, data averaging and setup calibration factors can be accounted for by Hewlett-Packard microprocessor controlled spectrum analyzers. All instrument controls, data transfer and data reduction can be handled by easy-to-write software for Automatic Spectrum Analyzers.

Frequency response: using a tracking signal source and a spectrum analyzer the frequency response of filters can be displayed with ease.

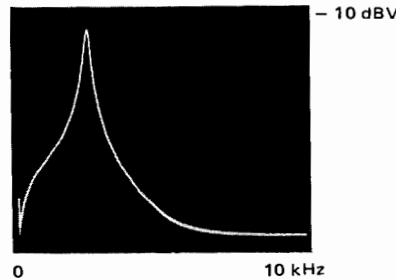

In this case, an audio filter used in a communications system is being measured. Since the input reference level to the filter is -13 dBV, the insertion loss at 2.4 kHz is 4 dB. Extremely high Q devices can be measured with this system.

Spectrum Analyzer Capabilities

To be useful in making measurements in the frequency domain, the analyzer must be capable of making quantitative measurements. Specifically, an analyzer must:

1. make absolute *frequency* measurements
2. make absolute *amplitude* measurements
3. operate over a *large amplitude dynamic range*
4. have *high resolution* of frequency and amplitude
5. have *high sensitivity*
6. provide means of *observing, preserving, and recording* its output in a convenient and rapid manner by using variable persistence, digital storage and adaptive sweep. Hewlett-Packard spectrum analyzers excel in these six measures of performance. Let us consider each of these performance standards in greater detail.

Absolute frequency measurements: Frequency readout accuracy depends upon the tuning and readout techniques employed, as well as the stability of the spectrum analyzer's frequency reference. The absolute frequency accuracy read off the slide-rule type of frequency dial is approximately 1% of full scale. Synthesized local oscillators allow accuracies to $\pm 4 \text{ Hz}$ at 1500 MHz in narrow

frequency spans. When the spectrum analyzer is used in conjunction with a tracking generator (a source whose frequency is the same as the analyzer tuning frequency) accuracy much better than 1% can be achieved by counting the generator output.

Absolute amplitude measurements: all Hewlett-Packard spectrum analyzers are absolutely calibrated for amplitude measurements. This means the spectrum analyzer indicates to the user what the log/reference level or linear sensitivity is regardless of control settings. Either a warning light or CRT message indicates an uncalibrated condition, making operation of the analyzer easy and foolproof.

Microprocessor controlled analyzers feature built-in calibration routines which account for changes in analyzer controls such as the resolution bandwidth and RF attenuator.

Dynamic range: the dynamic range of a spectrum analyzer is defined as the difference between the input signal level and the average noise level or distortion products whichever is greater. Hence, dynamic range can be either distortion limited, noise limited or display limited. Hewlett-Packard microprocessor controlled analyzers can be set to ensure that distortion products of on-screen signals will be below a certain level.

Frequency and amplitude resolution: frequency resolution is the ability of the analyzer to separate signals closely spaced in frequency. The frequency resolution of an analyzer is a function of three factors: 1) minimum IF bandwidth, 2) IF filter shape factor, 3) spectrum analyzer stability.

The minimum IF bandwidth ranges down to 1 Hz on Hewlett-Packard spectrum analyzers.

One way to define IF filter shape factor is the ratio of 60 dB bandwidth to 3 dB bandwidth. Filter shape factor specifies the selectivity of the IF filter. Hewlett-Packard spectrum analyzers have IF filter shape factors as low as 5:1.

Analyzer frequency stability also limits resolution. The residual FM (short term stability) should be less than the narrowest IF bandwidth. If not, the signal would drift in and out of the IF pass band. Hewlett-Packard analyzers have excellent stability. The residual FM ranges from $<1 \text{ Hz}$ at low frequency, to $<100 \text{ Hz}$ at microwave frequencies, enabling the measurement of noise sidebands. The stabilization circuitry is completely automatic and foolproof. No signal recentering, phase-lock loop, manual search, or checking is required.

Amplitude resolution is a function of the vertical scale calibration. Hewlett-Packard analyzers offer both log calibration for observing large amplitude variations (10, 5, 2 and 1 dB/div) and linear calibration for observing small amplitude variations.

Sensitivity: sensitivity is a measure of an analyzer's ability to detect small signals, and is often defined as the point where the signal level is equal to the noise level or $(S+N)/N=2$. Since noise level decreases as the bandwidth is decreased, sensitivity is a function of bandwidth. The maximum attainable sensitivity ranges from -150 dBm to -125 dBm with Hewlett-Packard analyzers.

Variable persistence, digital storage, and adaptive sweep: high resolution and sensitivity both require narrow bandwidths and consequently slow sweep rates. Because of these slow sweeps, both digital display and variable persistence are virtually indispensable in providing a bright, steady flicker-free trace.

The digital storage feature on Hewlett-Packard analyzers covering audio to microwave frequency ranges make measurements and CRT photography simple. It gives the CRT display a dot matrix connected by line generators for an unbroken and uniform intensity scan. In addition, the microprocessor controlled analyzers feature CRT annotation to completely describe the data characteristics displayed.

On low frequency analyzers, adaptive sweep effectively speeds the measurement times. On the very slow sweep times (required when using the 1 Hz bandwidth), adaptive sweep allows the scan to sweep rapidly when no signals occur and slow down when a signal is above a preset level. The measurement time savings can be greater than 20:1.

Tracking Preselector

The only way to simultaneously avoid spurious, multiple, harmonic and image responses is to filter the RF signal through a tracking preselector. This is an electronically tuned bandpass filter that automatically tracks the analyzer's tuning. A preselector improves the spurious-free range of the analyzer from 70 dB to 100 dB.

Tracking Generator

A tracking generator expands the measurement capability of the spectrum analyzer by providing a signal source which tracks the tuning frequency of the analyzer. The source/receiver combination can be used to measure insertion loss, frequency response, return loss and allow precision frequency counting.

It helps make these additional measurements with increased distortion-free dynamic range, sensitivity and selectivity. The tracking generator is also an excellent stable sweeping generator. The residual FM varies from ± 1 Hz for low frequency tracking generators to ± 400 Hz for microwave tracking generators.

Automatic Spectrum Analyzers

The measurement capability of a spectrum analyzer can be greatly enhanced by allowing a desktop computer to control instrument functions and record frequency and ampli-

tude information. Data can be gathered and processed into a variety of formats at a very rapid rate. Through comprehensive self-calibration, automatic spectrum analysis offers amplitude accuracy of up to ± 0.4 dB with 0.01 dB resolution. User cost savings are realized through faster measurements, lower operator skill requirements, and unattended operation capability.

Further discussion of computer based automatic spectrum analysis can be found on page 534.

Frequency Stability Analysis

Frequency stability and spectral purity are important parameters when characterizing precision frequency sources. Long term stability or frequency drift due to aging or temperature effects is generally measured with a precision frequency counter such as the HP 5345A; random fluctuations in frequency or phase stability can be measured in the time domain with an electronic counter and the Allan Variance technique.

Another measure of frequency stability is the phase spectral density. The most common method of making this measurement is to mix two signals together and feed the output into a lower frequency wave analyzer or spectrum analyzer. The technique works well for offset frequencies far away enough from the carrier to be compatible with the bandwidths of the analyzer.

For offset frequencies close to the carrier, (e.g. below 100 Hz) the bandwidths of analog analyzers become large in comparison to the frequencies being measured. As 1 Hz is approached, measurements become extremely difficult.

An automatic system for making phase spectral density measurements very close to the carrier is the HP 5390A Frequency Stability Analyzer which is based upon a high performance electronic counter and a programmable calculator. The counter is ideally suited to make measurements in the time domain, and the calculator can transform the data into the frequency domain. This technique allows measurements to be made from 0.01 Hz away from the carrier out to 10 kHz. Sensitivities greater than -150 dBc can typically be obtained at a 1 Hz offset on carriers ranging from 500 kHz to 18 GHz. The standard 5390A requires two sources which can be offset from one another. The 5390A option 010, based on the dual mixer time difference technique, can perform these same measurements on non-offsettable sources. For a more complete description of this automated technique refer to the 5390A Frequency Stability Analyzer on page 572.

Fourier Analyzers

The Fourier analyzer uses digital signal processing techniques to provide measurement capability over and above that of a swept spectrum analyzer. Some of these include the precise measurement of random signals obscured by noise, measurement of

the joint properties or relationships of two or more signals, measurements of statistical properties of signals, and measurements of very low frequency (e.g. below 5 Hz) or very closely spaced (e.g. less than 1 Hz) signals.

Fourier analyzers are based on the calculation of the Discrete Fourier Transform using a highly efficient algorithm known as the Fast Fourier Transform. As shown in Figure 2, this algorithm calculates the magnitude and phase of each frequency component from a block of time domain samples of the input signal.

The block diagram that is involved is shown in Figure 3. First, the input signal is filtered to remove out-of-band components. Next, the input is sampled and digitized at regular Δt intervals until a full block of samples called a time record has been collected. The processor then executes the desired series of computations on the time data to produce the frequency domain results. These results, which are stored in memory, can be analyzed on a CRT display, plotted, or processed further to provide the user additional useful information.

$$X(k \Delta f) = \sum x(n \Delta t) e^{-j2\pi(n)k/N}$$

EACH FREQUENCY POINT IS COMPOSED OF A MAGNITUDE AND PHASE VALUE

EACH FREQUENCY POINT CONTAINS INFORMATION FROM ALL TIME DOMAIN SAMPLES

COMPLEX FACTOR

Figure 2

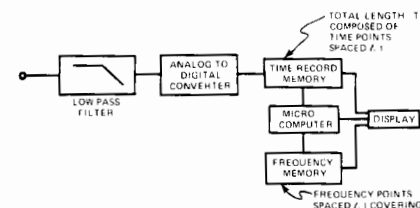

Figure 3

When two or more input channels are provided, signals can be sampled simultaneously. The processor can then additionally compute joint properties of the signals. This is useful for characterizing the transfer function of a linear device and for investigating cause/effect relationships.

The digital nature of Fourier analysis insures *high accuracy, stability and repeatability*. In addition, there are several specific advantages that are achieved.

Low Frequency Coverage

The Fourier transform calculates equally spaced frequency components from DC to the maximum frequency. By simply varying the sample rate it is possible to make measurements down to a few micro Hertz. For such low frequency measurements, the laws of physics dictate a long observation time. Since the Fourier transform simultaneously calculates all frequency points from one set of observation points, a one to two order of magnitude speed improvement over a swept measurement is possible.

SIGNAL ANALYZERS

Wave, Distortion, Modulation, Spectrum and Fourier Analyzers (Cont'd)

High Frequency Resolution

By digitally translating a band of frequencies down to DC it is possible to provide very high frequency resolution over the entire range. This technique, known as Band Selectable Fourier Analysis, can provide resolution of a few millihertz as shown in Figure 4. Here a 5 Hz band of frequency located at 3 kHz is analyzed showing 0.48 Hz sidebands over 20 dB down.

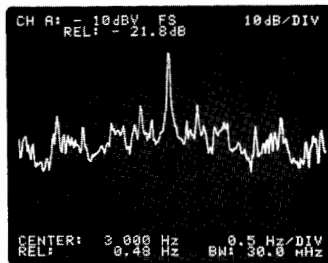

Figure 4

Direct Transfer Function Measurements

With simultaneous sampling of both the input and output of an electrical, mechanical, or acoustical system, it is possible to directly characterize transfer functions. Since the Fourier analyzer measures the frequency components simultaneously, energy must also be provided at these frequencies. This can be done with a broadband white noise signal, a pseudorandom noise signal or an impulse. Results presented in magnitude/phase or real/imaginary format help quickly illustrate the performance characteristics of a system.

The measurement of the coherence function can additionally provide a measure of the validity of a transfer function. It can distinguish portions of the output power that are not directly caused by the input, but may instead be due to additive noise, distortion products, or unmeasured inputs.

Systems Compatibility

Since the Fourier analyzer is basically all digital, interfacing to a computing controller or other digital peripherals is relatively simple. Remote programming and data input/output can considerably expand the range of potential applications.

Fourier Analyzer Applications

The versatility and performance of the Fourier analyzer make it an ideal tool for a variety of applications as a few specific examples will illustrate.

In the general area of electronics, the Fourier analyzer functions as a very high performance spectrum and network analyzer. It can be very useful for measuring phase noise or for characterizing filters.

In the field of communications, the Fourier analyzer can be very useful for characterizing audio signals, such as modems and touch tone signals.

When combined with a microphone the Fourier analyzer can be useful in characterizing acoustic devices, such as loud speakers.

With a motion transducer the Fourier analyzer can be used to analyze the vibration signatures of rotating machines. This can be very useful in helping to establish scientific maintenance policies.

The transfer function of a mechanical structure can illustrate how the structure responds to vibration inputs. This is extremely important in optimizing the design of structures that will be subjected to substantial vibration.

Wave Analyzers/SLM's

Wave analyzers are known by several different names: frequency selective voltmeter, carrier frequency voltmeter, and selective level meter. These names describe the instrument's function rather well.

As mentioned in the introduction to this section a wave analyzer can be thought of as a finite bandwidth window filter which can be tuned throughout a particular frequency range.

Signals will be selectively measured as they are framed by the frequency window. Thus, for a particular signal, the wave analyzer can indicate its frequency (window position) and amplitude. Amplitude is read on an analog meter; frequency is read on either a mechanical or electronic readout.

The uses of wave analyzers can be categorized into three broad areas: 1) amplitude measurement of a single component of a complex frequency system, 2) amplitude measurement in the presence of noise and interfering signals and, 3) measurement of signal energy appearing in a specified, well defined bandwidth.

Wave Analyzer/SLM

Considerations Frequency characteristics

Range: should be selected with the future in mind as well as present requirements.

Accuracy and resolution: should be consistent with available bandwidths. Narrow bandwidths require frequency dial accuracy to place the narrow window in the proper position for measurement. Accuracy of instruments with selectable bandwidths is determined by the basic center frequency accuracy of the IF bandwidth filters in addition to the local oscillator frequency accuracy.

Readout: usually an LED display.

Stability: frequency stability is important when using narrow bandwidths and for long term signal monitoring. Stability is best

achieved with automatic frequency control (AFC) or frequency synthesis. AFC locks the local oscillator to the incoming signal and eliminates any relative drift between the two. A frequency synthesized local oscillator allows frequency accuracy of $<1 \times 10^{-5}$ with 0.1 Hz resolution.

Sweep: some instruments are equipped with sweep to allow use as a spectrum analyzer. Readout is a CRT or X-Y recorder.

Amplitude Characteristics

Range: the amplitude range is determined by the input attenuator and the internal noise of the instrument. Sensitivity is defined as the lowest measurable signal equal to the noise level for a unity signal-to-noise ratio (often called tangential sensitivity). Sensitivity will vary with bandwidth and input impedance.

Dynamic Range: defined as the dB ratio of the largest and smallest signals that can be simultaneously accommodated without causing an error in the measurement.

Attenuators: the amplitude range switch is an attenuator in the input and IF stages. Intermodulation distortion is lowest when the input amplifier has the minimum signal applied and the IF gain is greatest. Conversely the internal noise, important when making sensitive measurements, is lowest with maximum input signal and lowest IF gain. Newer instruments use auto-ranging techniques.

Accuracy: amplitude accuracy is a function of frequency, input attenuator response, IF attenuator performance, calibration oscillator stability and accuracy, and meter tracking. Often specifications are expanded to separately describe each contributor.

Readout: amplitude readout is usually a meter calibrated in dB and/or volts or a LED digital display. Linear voltage meters are used to allow the user to see down into the noise at the bottom of the scale. Digital readouts are often used with an analog meter to aid in tuning to signals. Expanded scale meters allowing expansion of any 1 or 2 dB portion of the scale into a full scale presentation allow resolution of input level changes of a few hundredths of a dB while LED displays allow .01 dB resolution. This is useful when the wave analyzer is used as a sensitive indicator in bridge or comparison measurements. The expanded scale meter is included in some instruments and is an optional accessory on others.

Input Characteristics

Impedance: may be high impedance bridging input or terminating impedance to match standard transmission lines. High frequency measurements require matched systems to avoid error-producing standing waves on interconnecting cables. The measure of impedance accuracy is usually return loss or

reflection coefficient ($RL=20 \log \rho$). In low frequency instruments, percent accuracy is used. High input impedance instruments are usually poorer in high frequency and noise performance and are usually low frequency instruments. High impedance at high frequencies is accomplished by using a bridging probe to place the impedance at the point of measurement. The probe may be active with unity gain or passive with 20-30 dB insertion loss.

Input arrangement: input may be balanced to ground or unbalanced. Communications system usage typically requires balanced input. Standard 600 and 135/150 Ω balanced inputs are limited in frequency to less than 1 MHz and 124 Ω balanced to less than 10 MHz in most instruments. The impedance may be balanced to ground with the center point grounded or may be completely isolated from ground. Unbalanced inputs do not have frequency range limitations.

Network Analysis Application

Frequency response testing: with its tracking generator output, the wave analyzer is particularly useful for measuring filter and amplifier frequency responses. If a notch filter is being measured, for example, a narrow band measurement like that provided by a wave analyzer is essential for obtaining acceptable accuracy. A broadband technique will lead to some misleading results. For example, a notch filter may be driven with a flat oscillator and the response measured with a broadband voltmeter. The notch filter will reject the oscillator's fundamental tone, but pass its harmonics which are in voltmeter's measurement range. Thus, an error results. If the voltmeter were frequency selective, like a wave analyzer, the harmonics would be rejected and the true level of the notch would be measured. Accurate and fast measurements can be made because Hewlett-Packard wave analyzers track and detect on the tracking generator frequency.

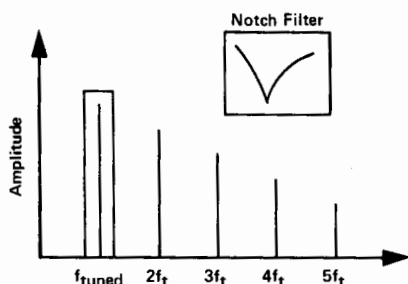

Only signal detected by wave analyzer. For example, the notch of a filter can be accurately measured to its full depth.

Distortion, Audio Analyzers

Harmonic distortion is one of many types of distortion created in communications equipment, audio and ultrasonic sound sys-

tems. Nonlinear elements in amplifiers cause harmonic related frequencies from a pure tone stimulus to be created at the output. Hence, to a listener, a poor reproduction quality becomes apparent. The total of these frequency components present in a signal, in addition to the fundamental frequency, can be measured quickly and easily with Hewlett-Packard distortion and audio analyzers.

The ratio of these frequency components to the amplitude of the fundamental is the total harmonic distortion (THD) as defined by the following equation (1):

$$THD = \frac{\sqrt{\sum (\text{harmonics})^2}}{\text{fundamental}}$$

The Hewlett-Packard distortion and audio analyzers consist of a narrow band rejection filter and broadband detector. Before the fundamental is rejected, the analyzer first measures the amplitude of the fundamental, all the harmonic components, and noise. Then the rejection filter is employed to remove the fundamental. The ratio of the two measurements is an approximation of equation (1) above and is defined by the following equation (2):

$$THD = \frac{\sqrt{\sum [(\text{harmonics})^2 + (\text{noise})^2]}}{\sqrt{\sum [(\text{fundamental})^2 + (\text{harmonics})^2 + (\text{noise})^2]}}$$

An approximation error of 1/2% can be expected for the THD levels of 10%. However, distortion levels as high as 10% are seldom encountered in most measurement situations. The harmonic content of the stimulus source must not be more than a third of the distortion expected to be caused by the system under test.

Audio Analyzers

The Audio Analyzer performs several basic low frequency measurements in addition to distortion, making it a general purpose audio test set. The audio analyzer includes the SINAD function for testing mobile radio receiver sensitivity. It contains a low distortion audio oscillator for stimulus response testing in combination with its distortion analyzer. It contains a true rms voltmeter and dc voltmeter for accurate measurement of complex waveform levels. Swept ac level and swept distortion measurements can be made when using the audio analyzer with a suitable X-Y recorder. Signal to noise ratio measurements are performed automatically when using the internal source and rms voltmeter. A reciprocal frequency counter is also included that continuously counts the frequency of the input signal.

These basic capabilities provide a general purpose instrument that represents high value in three major applications areas: 1) General audio component characterization, 2) radio transceiver audio measurements, 3) HP-IB systems. The Audio Analyzer provides sophisticated measurement capabilities with significantly reduced operator interaction.

True Harmonic Distortion Measurements

The Hewlett-Packard desk-top computer controlled automatic spectrum analyzers provides the user a rapid means of measuring true harmonic distortion levels. The fundamental and its harmonic components are rapidly measured one at a time and the distortion is computed by applying equation (1). In production test situations, distortion calculations can be stored on tape for future reference and/or plotted for hard copy needs. Limit testing can also be applied.

Modulation Analyzers

A modulation analyzer is a precision receiver, designed to detect the entire modulation envelope of a signal under test. It can measure and display the carrier characteristics of RF frequency and power as well as AM, FM and phase modulation characteristics such as AM depth, peak deviation, residual modulation, and various ratios associated with them. The modulation analyzer also faithfully recovers the actual modulating signal for further analysis such as distortion testing.

Applications for modulation analyzers center mostly in transmitter testing and signal generator calibration. The precision receiver capability allows comprehensive testing of the transmitter. All phases of design, production test, and maintenance of transmitters and their modules and subassemblies are applications. And since signal generators are "precision transmitters", numerous applications will be found in metrology and calibration labs for signal generator calibration.

Capabilities

The unique measurement capabilities of modulation analyzers are easily shown on system tests with multiple-mode modulations such as simultaneous AM and FM. For example, if both amplitude and frequency modulation are present on a signal, a complex modulation spectrum is produced. To demonstrate this, an HP 8640B Signal Generator was 46.5% amplitude modulated with a 5 kHz triangular wave and 4.5 kHz peak frequency modulated with a 5 kHz sine wave simultaneously. The picture below shows the resulting signal as seen on a spectrum analyzer.

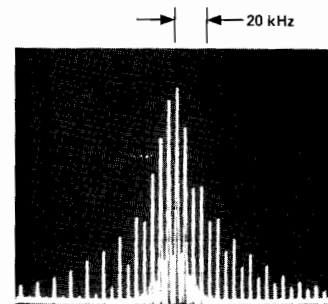

Spectrum Analyzer display of simultaneous AM (46.5%) and FM (4.5 kHz pk deviation) modulation.



SIGNAL ANALYZERS

Wave, Distortion, Modulation, Spectrum and Fourier Analyzers (Cont'd)

Unequal, complex sidebands result and little data can be deduced. However, since a modulation analyzer faithfully recovers both modulation signals in independent detection systems insensitive to each other, it is easy to separate and read directly the various modulation components involved.

500.00 184 MHz

46.5 %AM

9.942 -3 Watts

4.49 kHz FM

Modulation Analyzer displays of RF signal parameters.

In addition, since the modulation analyzer handles the full complex modulation envelope, it measures and displays peak RF envelope power and average frequency of the entire signal. The readings are all available at the push of a button.

The independent detection systems demodulate the waveforms and present the resulting signal at the output for viewing on an oscilloscope or for further analysis by a distortion analyzer or audio wave analyzer.

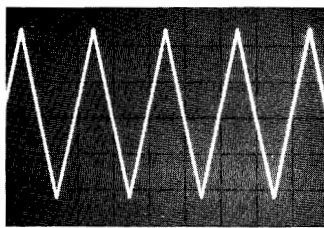

Recovered 5 kHz AM input signal viewed on oscilloscope.

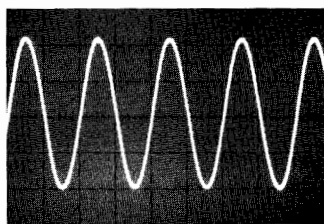

Recovered 5 kHz FM input signal.

Since the AM and FM detection systems are independent and highly insensitive to each other, incidental modulation measurements can be made with high precision. For example, even with 90% amplitude modulation, the FM demodulator will accurately indicate incidental FM. Such capability is

valuable for design of oscillators, modulators, mixers and other components. It is very difficult to separate multiple modulation effects on spectrum analyzer displays because the effects are combined.

The HP 8901A Modulation Analyzer contains selectable filters to provide commonly used system characteristics for low-pass and high-pass filtering and FM de-emphasis. Thus measurement of transmitter modulation frequency response doesn't require additional equipment. Selectable detectors, including peak hold, allow measurements such as transmitter modulation limiting to be made very easily.

Finally the modulation analyzer can serve as a high sensitivity, selective frequency counter. Since the superheterodyne design allows high sensitivity amplification of low level modulated signals, frequency counting of signals as low as -65 dBm is possible with good rejection of other signals, even large interfering ones.

Display and computational conveniences speed typical transmitter measurements and improve confidence in results. For example, ratio keys allow any measurement to be expressed in % or dB relative to any other measured or key-entered value. Such computations are valuable in applications such as mobile FM measurements, where hum and noise is expressed relative to an industry standard of 60% of maximum allowable deviation.

Signal Analyzers Selection Guide

Spectrum Analyzers

Frequency Range	Amplitude Calibration Range	Bandwidths		Model Description	Companion Instruments	Page
		Min	Max			
0.02 Hz-25.6 kHz	-120 to +30 dBV	0.02 Hz	363 Hz	3582A Spectrum Analyzer		560
5 Hz-50 kHz	-150 to +30 dBm	1 Hz	300 Hz	3580A Spectrum Analyzer		558
20 Hz-300 kHz	-142 to +10 dBm	10 Hz	10 kHz	8556A Tuning Section Plug-In ¹		548
10 Hz-13 kHz	-140 to +20 dBm	3 Hz	10 kHz	3044A/45A Spectrum Analyzer		565
20 Hz to 40.1 MHz	-137 dB to +30 dBm	3 Hz	30 kHz	3585A Spectrum Analyzer		520
1 kHz-110 MHz	-140 to +10 dBm	10 Hz	300 kHz	8553B Tuning Section Plug-In ¹	8443A Tracking Generator	550
10 kHz-350 MHz	-117 to +20 dBm	1 kHz	3 MHz	8557A Spectrum Analyzer Plug-In ¹	8750A Storage-Normalizer	540
100 kHz-1250 MHz	-122 to +10 dBm	100 Hz	300 kHz	8554B Tuning Section Plug-In ¹	8444A Tracking Generator (500 kHz-1250 MHz)	552
100 kHz-1500 MHz	-117 to +30 dBm	1 kHz	3MHz	8558B Spectrum Analyzer Plug-In ¹	8750A Storage-Normalizer 8444A Opt. 059 Tracking Generator (500 kHz-1500 MHz)	542
100 Hz-1500 MHz	-137 dBm to +30 dBm	10 Hz	3 MHz	8568A Spectrum Analyzer and 8581B Automatic Spectrum Analyzer	8444A Opt. 059 Tracking Generator (500 kHz-1500 MHz) 85650A Quasi-Peak Adapter	528 534
10 MHz-21 GHz	-111 dBm to +30 dBm	1 kHz	3 MHz	8559A Spectrum Analyzer	8750A Storage-Normalizer	544
100 Hz-40 GHz ⁴	-134 dBm to +30 dBm	10 Hz	3 MHz	8566A Spectrum Analyzer and 8582B Automatic Spectrum Analyzer	85650A Quasi-Peak Adapter	531 534
10 MHz-40 GHz ²	-122 dBm to +30 dBm	100 Hz	3 MHz	8565A Spectrum Analyzer	8750A Storage-Normalizer 8444A Opt. 059 Tracking Generator (10 MHz-1500 MHz)	538
10 MHz-40 GHz ²	-123 to +30 dBm	100 Hz	3 MHz	8569A Spectrum Analyzer	8444A Opt. 059 Tracking Generator (10 MHz-1500 MHz)	536
10 MHz-40 GHz ²	-127 to +10 dBm	100 Hz	300 kHz	8555A Tuning Section Plug-In ¹	8444A Opt. 059 Tracking Generator (10 MHz-1500 MHz) 8445B Automatic Preselector (10 MHz-18 GHz)	554
0.01 Hz-10 kHz offset from carrier 500 kHz-18 GHz carrier range	-150 dBc min.	<100 μHz	10 kHz	5390A Frequency Stability Analyzer	59309A Digital Clock	572

NOTE 1: For use in oscilloscope mainframes 140T and 141T with IF section plug-ins 8552A or 8552B (page 546).

NOTE 2: For use in oscilloscope mainframes 180TR, 181T/TR and 182T.

NOTE 3: Frequency range extendable to 170 GHz with commercially available mixers.

NOTE 4: Frequency range extendable to 220 GHz with commercially available mixers.



Modulation Analyzer (8901A)

Frequency Range	Modulation				RF Level Accuracy	Audio Filters		Page
	Mode	Range	Accuracy	Distortion		Type	Time Constant/Frequency	
150 kHz-1300 MHz	FM	40 kHz pk ($f_c \leq 10$ MHz) 400 kHz pk ($f_c > 10$ MHz)	1% of reading ± 1 digit (rates 30 Hz-100 kHz)	<0.1% THD	± 2 dB ($f_c < 650$ MHz)	Low-pass	3 kHz 15 kHz >20 kHz	578
	AM	0-99%	1% of reading ± 1 digit (rates 50 Hz-50 kHz)	<0.3% THD	± 3 dB ($f_c > 650$ MHz)	High-pass	50 Hz 300 Hz	
	Φ M	400 radians ($f_c > 10$ MHz, rate < 1 kHz)	3% of reading ± 1 digit (rates 200 Hz-20 kHz)	<0.1% THD		De-emphasis	25 μ s 50 μ s 75 μ s 750 μ s	

Digital Signal Analyzers

Frequency Range	Amplitude Calibration Range	Resolution Points		Model Description	Functions Available	Page
		Min	Max			
DC-100 kHz (See Note 1)	7 steps from ± 0.125 to ± 8 V	32	2048	5451C Fourier Analyzer (See Note 3)	Power spectrum Transfer function Coherence Convolution	570
DC-25 kHz	7 Steps From ± 0.1 to ± 10 V	256	32,000 (See Note 2)	5420A Digital Signal Analyzer 5423A Structural Dynamic Analyzer (See Note 3)	Time Average Linear Spectrum Auto Spectrum Transfer Function Coherence Function Histogram Correlation Impulse Response	568
0.1-25 kHz	7 steps from ± 0.125 to ± 8 V	256 PS 128 TF	1024 PS 512 TF	5427A Digital Vibration Control System (Analysis Mode)	Power Spectrum (PS) Transfer Function (TF) Transient Capture Shock Response Spectrum	571
0.02 Hz-25.6 kHz	9 steps from 3 mV to 30 V RMS	256	$> 1.3 \times 10^6$ (See note 2)	3582A Spectrum Analyzer	Voltage Spectrum Phase Spectrum Transfer Function Coherence Function Digital Averaging	560

NOTE 1: Standard range is DC to 50 kHz, expandable with options to 100 kHz.

NOTE 2: Equivalent number of points using Band Selectable Analysis.

NOTE 3: Also includes modal analysis capability.

Distortion/Audio Analyzers

Fundamental Frequency Range	Minimum Distortion	Auto Set Level	Auto Nulling	True RMS	AM Detector	Filters	Model No.	Internal Source	HP-IB	Page
5 Hz to 600 kHz	.03% (-70 dB)						331A			576
							333A			576
							334A			576
							334A Opt 002			576
10 Hz-110 kHz	0.0018% (-95 dB)	*	*	*	*	*	339A	*		574
20 Hz-100 kHz	0.01% (-80 dB)	*	*	*	Note 1	*	8903A*	*	*	581

*The 8903A also performs Frequency Count, Signal/Noise, SINAD, watts, ac/dc volts measurements.

NOTE 1: The 8901A Modulation Analyzer (p. 578) provides complete demodulation of AM, FM, and Φ M signals.

Wave Analyzers/Selective Level Meters

Frequency Range	Selective Bandpass	Dynamic Range		Freq. Readouts	Type of Inputs	Type of Outputs	Modes of Operation	Model Number	Page
		Absolute	Relative						
15 Hz to 50 kHz	3 Hz 10 Hz 30 Hz 100 Hz 300 Hz	0.1 μ V-300 V full scale	>85 dB	5-place digital	Banana Jacks	rec: 5 V full scale, with pen lift BFO, Local Oscillator, tuning loudspeaker, and headphone jack	AFC, normal. BFO	3581A/ 3581C	577 602
50 Hz to 32.5 MHz	20 Hz 400 Hz 3100 Hz	-130 to +20 dBm	>80 dB	LED, .1 Hz Resolution	50/75 Ω BNC 600 Ω Banana Jacks	Tracking Generator Audio/Loud Speaker 1 MHz Ref.	Wideband Selective USB/LSB	3586C (3336C*)	523 388
50 Hz to 32.5 MHz	20 Hz 400 Hz 1740/2000 Hz Optional 3100 Hz WTD	-130 to +20 dBm	>70 dB	LED .1 Hz Resolution	75 Ω BNC/WECO 124 Ω WECO 135 Ω WECO 150 Ω Siemens 600 Ω WECO/ Siemens	Tracking Generator Audio/Loud Speaker 1 MHz Ref.	Wideband Selective SSB	3586A/B (3336A/B*) (3335A)	624 626 630

*Tracking Synthesizers.

SIGNAL ANALYZERS

20 Hz to 40 MHz Spectrum Analyzer

Model 3585A

- 80 dB dynamic range
- 3 Hz resolution bandwidth
- ± 0.4 dB amplitude accuracy
- Self-calibrating

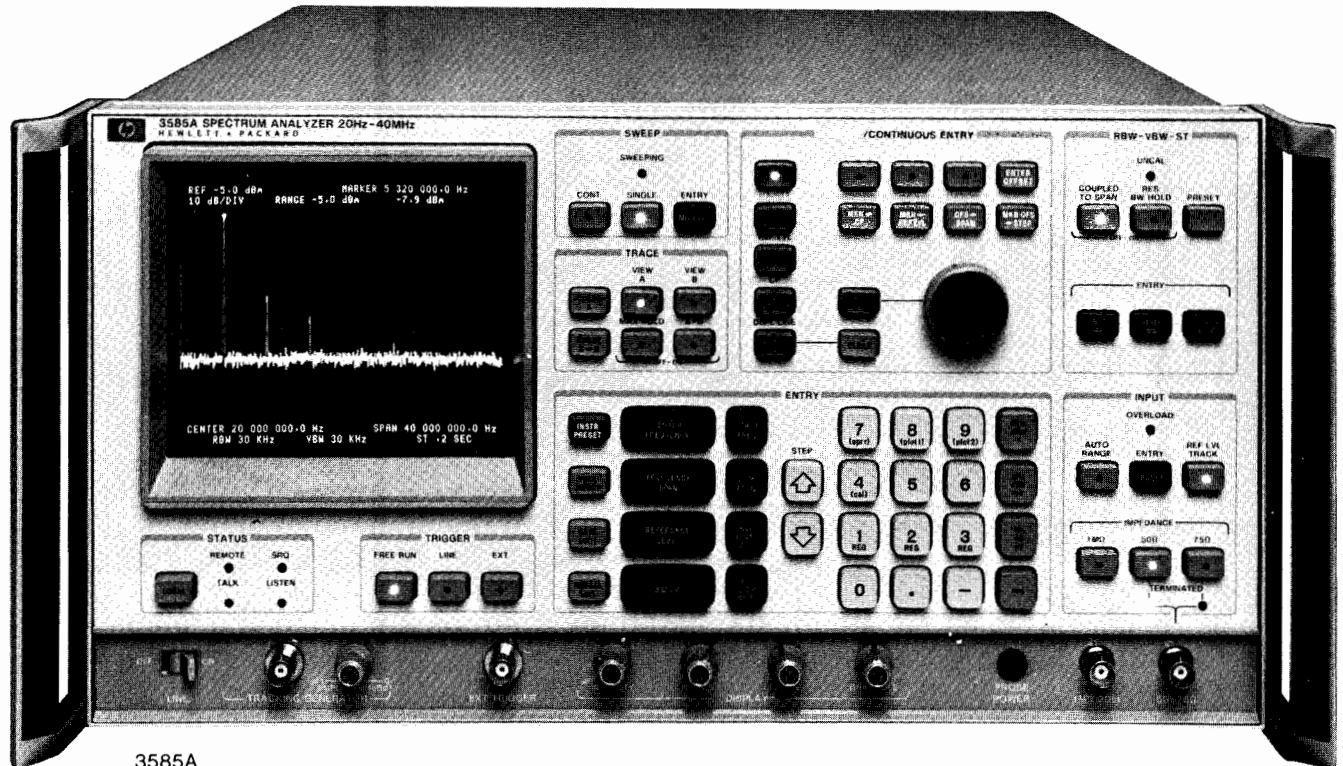

3585A
(Shown with Opt. 907)



Description

The HP 3585A Spectrum Analyzer has a fully synthesized local oscillator controlled by a microprocessor. The result of this state-of-the-art contribution offers outstanding performance over its frequency range of 20 Hz to 40.1 MHz. Center frequency and span settings have 0.1 Hz resolution and 1×10^{-7} /mo. stability over its entire operating range. The frequency precision and stability enables the 3 Hz resolution bandwidth filter to be used for close-in analysis even at 40 MHz.

An automatic internal calibration routine, administered by the microprocessor, provides up to ± 0.4 dB accuracy over most of the measurement range. Improvements in measurement performance of this magnitude cannot be realized by the user unless the basic limitations of the CRT display are bypassed. This has been accomplished by digitizing the detected video signal, which is then stored in memory. Photographic documentation of the display is greatly simplified by displaying all the essential frequency, amplitude and resolution parameters alpha-numerically around the edge of the CRT.

The power of the microprocessor provides a bonus by making this analyzer easier to use. Several of the usually tedious operations, such as centering a signal, raising it to the reference level, etc., are now simplified with dedicated key operated routines working in conjunction with the display marker. Adjustment of resolution and video bandwidth when modifying span is now an automatic function unless individual manual selection is required. In addition, new functions have been added, such as noise power density measurements and off-set capability for both frequency and amplitude.

Measurement Power & Convenience

The power and convenience of the 3585A's microcomputer-based controls and CRT readout simplify and speed use in so many ways that previously impractical analysis now become routine. Functions such as center frequency and amplitude reference level may be keyboard-set with 0.1 Hz and 0.1 dB precision, varied with an 'analog' knob (actually a rotary pulse-generator), or incrementally key-stepped. The autoranging input attenuator eliminates the error-prone task of adjusting the attenuator to achieve the correct mixer level.

A tunable marker in the 3585A makes basic measurements precise and quick by directly measuring a signal or by speeding the process of magnifying the portion of the spectrum to be analyzed. With the marker set to the signal peak, signal amplitude and frequency (with counter accuracy) are numerically displayed on the CRT. A second marker makes relative measurements instantly available with numerical display of the difference in amplitude and frequency between the two markers. This is useful for modulation, distortion measurements, and bandwidth measurement. For example, in the case of telecommunications applications, the second marker can be set at harmonic or channel spacing from the first so the operator can simply step frequencies to track higher order harmonics or additional channels.

Amplitude and frequency may be offset to normalize values to some reference signal such as a pilot tone or to reflect the relative value of a signal. Other amplitude units, such as dBV or volts, can be chosen. On any occasion all settings can be stored, then later recalled with a short key sequence. As many as three sets of settings may be stored.

Two different traces each of 1001 horizontal points, may be taken, stored in memory, then shown separately or together as desired while comparisons among them may be calculated and displayed digitally on the CRT. A Max Hold key causes the largest amplitude in successive sweeps to be displayed, making it easy to measure residual FM or drift. A built-in tracking generator, with a maximum output of 0 dBm, enables frequency response measurements to be made.

Automatic Measurements

Not only are all 3585A functions remotely-programmable via the HP Interface Bus (IEEE Standard 488-1975), the instrument also can be commanded to transfer its measurements out via the bus for interpretation and further interaction by a computing controller. The analyzer can be remotely tuned with the precision of the synthesizer, while retaining analog sweep and exceptional spectral purity. The result is a new and higher level of interaction between the user and the measurement system.

Frequency Accuracy

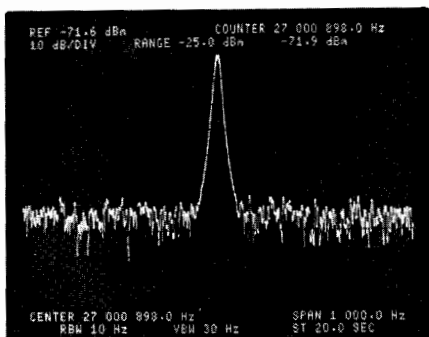

Counter measurements with spectrum analyzer selectivity and sensitivity can be made to 1×10^{-7} /mo. stability while sweeping or manually tuning.

Dynamic Range

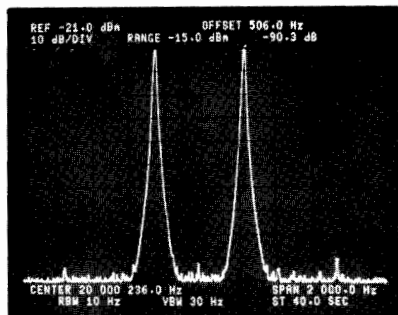

>80 dB spurious free dynamic range with full scale inputs of -25 dBm to +30 dBm in 5 dB steps. Autoranging input provides full dynamic range with no guesswork.

Internal Calibration

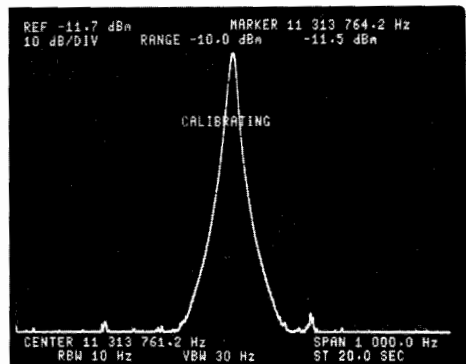

Maximum accuracy is assured at all times by an automatic internal calibration routine which compensates for frequency and amplitude errors in measurements made at the reference level at the center of the screen.

Swept Response Measurements

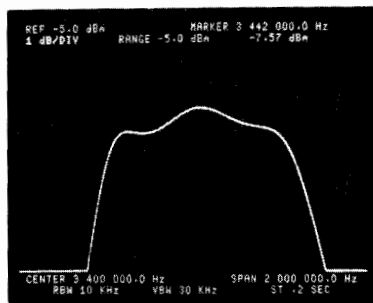

The built-in tracking generator offers superb stability and resolution for crystal filters as well as excellent flatness for wideband devices. The 1 dB/div. amplitude scale is used to expand and resolve small amplitude differences with .01 dB resolution using the marker readout.

Marker Aided Measurements

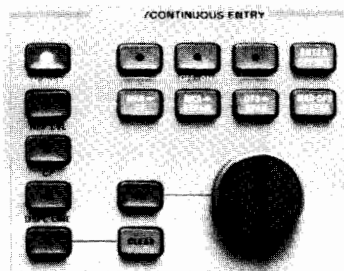

Along with the marker readout capability, there are three additional functions: counter measurements, noise level measurements, and offset (relative) measurements. The four operating aids just above the knob indicate that the marker or offset value can be directly entered into the center frequency, reference level, frequency span, or center frequency step size. These aids save much time in conventional operations by direct transfer of data to another functional control.

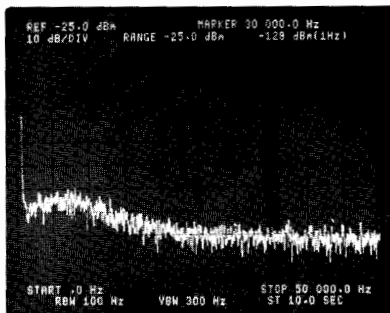

Noise Measurement

The noise level key displays RMS noise density normalized to a 1 Hz bandwidth at the marker position. All correction factors are accounted for in the internal measurement routine.

Terminal Interaction

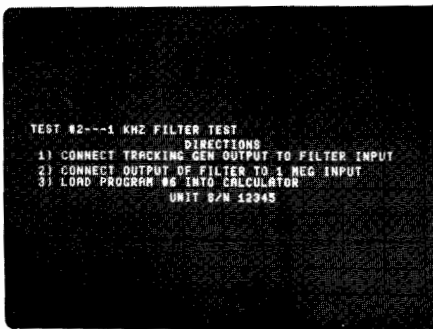



Measurement routines selected from the controller memory via the analyzer keyboard, such as this filter test, can provide instructions to the operator to minimize errors and reduce training time for complex measurements.

Specifications

Frequency

Measurement range: 20 Hz to 40.1 MHz

Displayed Range

Frequency span:

Range: 0 Hz to 40.1 MHz variable with .1 Hz resolution or 10 Hz to 40 MHz in 1, 2, 5 steps

Accuracy: $-0\% + .2\%$ of frequency span setting

Center, Start/Stop, and Manual Frequency

Range: 0 Hz to 40.1 MHz with .1 Hz resolution

Accuracy: 1×10^{-7} /month of frequency

Marker

Readout accuracy: $\pm 2\%$ of frequency span \pm resolution bandwidth

Counter accuracy: $\pm .3$ Hz $\pm 1 \times 10^{-7}$ /month of counted frequency for a signal 20 dB greater than other signals and noise in the resolution bandwidth setting

Resolution

Resolution bandwidths

Range: 3 dB bandwidths of 3 Hz to 30 kHz in a 1, 3, 10 sequence

Accuracy: $\pm 20\%$ at the 3 dB points

Selectivity: 60 dB/3 dB $< 11:1$

Amplitude

Measurement range: -137 dBm to $+30$ dBm (50/75 Ω) or equivalent level in dBV or volts, 31 nV to 22 V (1 M Ω)

Displayed Range

Scale: 10 division CRT vertical axis with Reference Level at the top graticule line

Calibration: 10, 5, 2 and 1 dB/division from the Reference Level

Input range: -25 dBm to $+30$ dBm in 5 dB steps

Reference level (relative to Input Range)

Range: -100 dB to $+10$ dB

Accuracy (using 1 or 2 dB/div., at midscreen with sweep rate reduced by 4 or at the manual frequency):

50/75 Ω input:

+10 dB	-50 dB	-70 dB	-90 dB
$\pm .4$ dB	$\pm .7$ dB	± 1.5 dB	

1 M Ω input - add to above

20 Hz	10 MHz	40.1 MHz
$\pm .7$ dB	± 1.5 dB	

Amplitude linearity (referred to Reference Level)

0 dB	-20 dB	-50 dB	-80 dB	-95 dB
$\pm .3$ dB	$\pm .6$ dB	± 1.0 dB	± 2.0 dB	

Frequency response (referred to center of span)

50/75 Ω input: $\pm .5$ dB

1 M Ω input:

20 Hz	10 MHz	40.1 MHz
$\pm .7$ dB	± 1.5 dB	

Marker

Amplitude accuracy

Midscreen at the reference level: Use Reference Level accuracy from $+30$ dBm to -115 dBm, add Amplitude Linearity below -115 dBm.

Anywhere on screen: Add Reference Level Accuracy, Amplitude Linearity and Frequency Response.

Dynamic Range

Spurious responses (image, out of band, and harmonic distortion):

50/75 Ω input: < -80 dB referred to a single signal equal to or less than Input Range

1 M Ω input: < -80 dB except second harmonic distortion < -70 dB

Intermodulation distortion:

50/75 Ω input: < -80 dB referred to the larger of two signals

each ≥ 6 dB below Input Range except 2nd order IM from 10 MHz to 40 MHz < -70 dB

1 M Ω input: < -70 dB

Residual responses (no signal at input): < -120 dBm using -25 dBm range

Average noise level

50/75 Ω input:

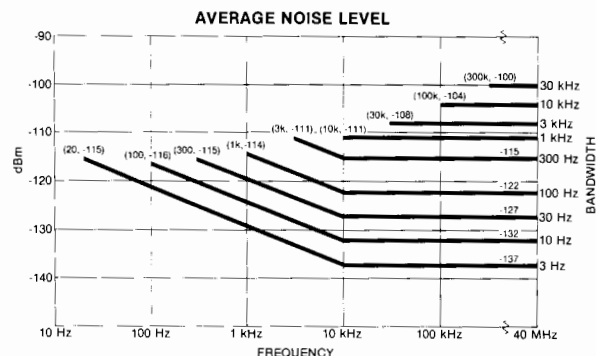

1 M Ω input: Below 500 kHz add 12 dB to above

Sweep

Modes: Continuous, single or manual

Trigger: Free Run, Line, or External

Time: .2 s full sweep to 200 s/Hz of Frequency Span (swept time excluding auto calibration cycles)

Input

Signal inputs:

50/75 Ω : > 26 dB return loss, BNC connector

1 M Ω : $\pm 3\%$ shunted by < 30 pf, BNC connector

Maximum input level:

50/75 Ω : 13 V peak ac plus dc relay protected against overloads to 42 V peak.

1 M Ω input: 42 V peak ac plus dc (derate by factor of two for each octave above 5 MHz).

External trigger input: Negative going TTL level or contact closure required to initiate sweep.

External reference input: 10 MHz (or subharmonic to 1 MHz), 0 dBm minimum level

Output

Tracking generator:

Level: 0 dBm to -11 dBm with a single turn knob

Frequency accuracy: ± 1 Hz relative to analyzer tuning

Frequency response: $\pm .7$ dB

Impedance: 50 Ω ; > 14 dB return loss

Probe power: $+15$ Vdc, -12.6 Vdc; 150 ma max.

Suitable for powering HP 1120A Active Probe

External display:

X, Y: 1 volt full deflection; Z: < 0 V to > 2.4 V

Recorder:

X Axis: 10 V full scale

Y Axis: 10 V full scale

Z — penlift output TTL

IF: 350 kHz, -11 dBV to -15 dBV at the reference level

Video: 10 V at the reference level

Frequency reference: 10.000 MHz $\pm 1 \times 10^{-7}$ /mo., $+10$ dBm into 50 Ω

General

Environmental

Temperature: Operating 0°C to 55°C

Humidity: $< 95\%$ RH except 300 Hz BW $< 40\%$ RH

Warm-up time: 20 minutes at ambient temperature

Power requirements: 115 V ($+11\%$ -25%), 48-440 Hz

230V ($+11\%$ -18%), 48-66 Hz

180 Watts 3A max

Weight: 39.9 kg (88 lb.)

Size: 22.9 cm (9") H \times 42.6 cm (16.75") W \times 63.5 cm (25") D

Ordering Information

Opt. 907: Front Handle Kit	add \$72.50
Opt. 908: Rack Flange Kit	add \$35.00
Opt. 909: Combined Opt. 907 and 908	add \$97.50
Opt. 910: Extra Manual	add \$150
Model 3585A Signal Analyzer	\$21,000

SIGNAL ANALYZERS

50 Hz to 32.5 MHz Selective Level Meter

Model 3586C

523
hp

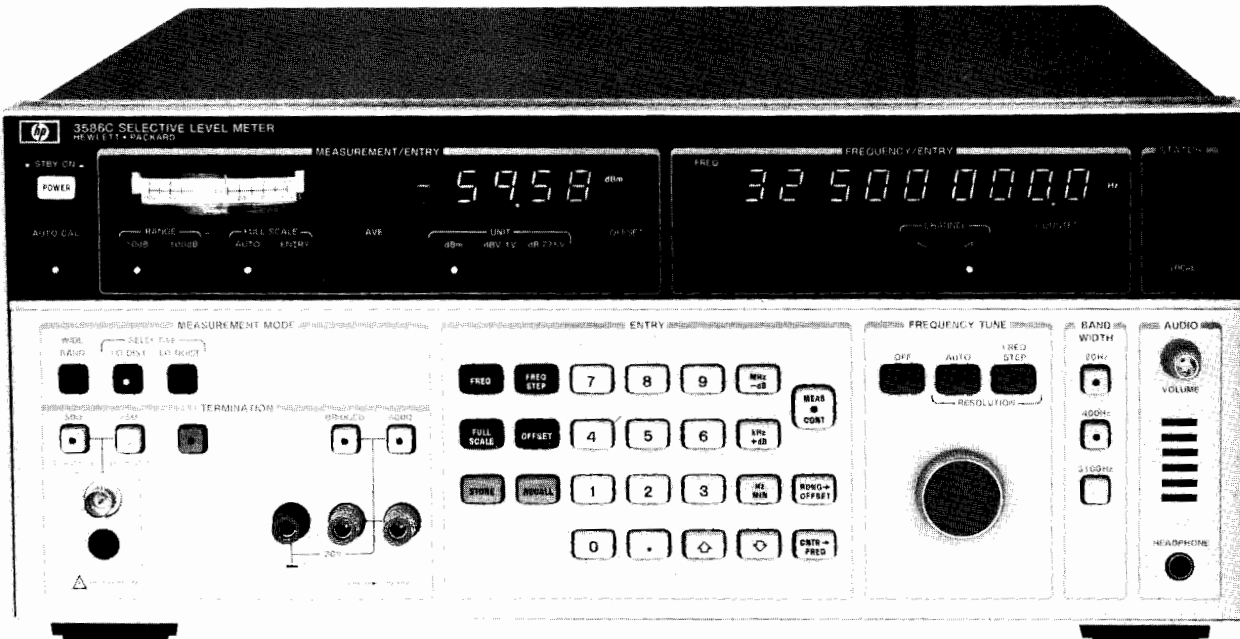

3586C



Description

The 3586C selective Level Meter is designed for general purpose wave analysis applications in the design, manufacture, and maintenance of electronic systems.

Microprocessor control and HP-developed fractional-N synthesis provides precise frequency setting and time saving ease-of-use features, and the 3586C is fully HP-IB programmable.

The 3586C Selective Level Meter covers the frequency range from 50 Hz to 32.5 MHz allowing measurement of audio, sonar, and other low frequency systems as well as high frequency communications and sub-systems. Input impedances of 50, 75, or 600 Ω with 10 k Ω bridging adds measurement flexibility for a wide variety of applications.

Wideband power measurements can be made up to 32.5 MHz and down to -45 dBm. Measure selectively in LO Distortion or LO noise modes or use USB or LSB for single sideband demodulation of a carrier.

Measurement Precision

Signal levels are measured with up to ± 0.2 dB accuracy down to -80 dBm with .01 dB resolution and bandwidth choices of 20, 400, or 3100 Hz. Automatic level calibration eliminates the need for manual calibration operations prior to critical level measurements. Frequency can be set precisely with 0.1 Hz resolution and $\pm 1 \times 10^{-5}$ stability ($\pm 2 \times 10^{-7}$ optional). The built-in frequency counter allows you to measure the frequency of a signal greater than -100 dBm within the filter bandwidth chosen and then tune the center of the filter passband precisely to that signal with one keystroke.

Selective Measurements

Make measurements on signals as close as 80 Hz spacing with 50 dB rejection using the 20 Hz filter. Use the extremely selective 3100 Hz filter for telecommunications channel level or noise measurements with 60 dB carrier rejection and 75 dB adjacent channel rejection, or demodulate the upper or lower sideband signal for further processing and listen to it with the speaker output.

Level Offset

Measurements can be made with respect to an entered offset level such as the fundamental signal level. Relative measurements can be made with respect to any keyboard entered or measured level, saving

time-consuming operator calculations.

Digital or Analog Frequency Control

Frequencies may be entered directly on the keyboard with 0.1 Hz resolution and then changed by entering any step size and stepping up or down in frequency, or use the analog frequency tune control. The analog frequency tune control will change frequency in automatically chosen steps proportional to the bandwidth chosen, or in the step size entered.

Nine Storage Registers

Nine different combinations of front panel settings can be stored in the non-volatile storage registers and then recalled at a keystroke—even if the instrument has been turned off. Significant time is saved when repetitive testing is required in manufacturing, development, or metrology environments.

Tracking Synthesizer

The 3586C will operate in the frequency tracking mode with either the 3336C Synthesizer (see page 388) for measurements up to 20.9 MHz, or the 3335A Synthesizer (see page 386) for full frequency coverage up to 32.5 MHz. The tracking synthesizer will automatically tune to the frequency programmed on the 3586C in the tracking mode when their HP-IB interfaces are connected together with a bus cable.

Use the tracking mode to save time in amplitude-only network analysis or for loop-around measurements in telecommunications systems.

Fully Programmable

All necessary functions on the 3586C Selective Level Meter are programmable on the HP-IB using a desktop computer controller such as the HP Model 85F, 9825T, 9835A, or 9845B, or a mainframe computer such as the HP-1000. All measurements and necessary frequency and front panel settings can be interrogated and read out to the bus for print-out or further data processing.

High Impedance Accessory Probe

Model 1124A 100 MHz Active Divider Probe provides high voltage, high impedance general purpose probing capability for the 50 ohm input impedance on the 3586C Selective Level Meter (see page 226 for specifications).



TOTAL HARMONIC DISTORTION TEST

FUNDAMENTAL FREQ	ABSOLUTE AMP
10,805.1 Hz	1.18 dBm
HARMONIC FREQ	RELATIVE AMP
2 21,610.2 Hz	-50.65 dB
3 32,415.3 Hz	-50.36 dB
4 43,220.4 Hz	-72.35 dB
5 54,025.5 Hz	-50.55 dB
6 64,830.6 Hz	-67.73 dB

THD = -46.89 dB OR 0.45 %

The 3586C and an HP computer were used to characterize a function generator for total harmonic distortion as well as harmonic level.

Distortion Measurements

The front panel convenience features of the 3586C allow fast, accurate measurement of individual harmonic levels. To measure harmonic levels relative to the fundamental, first measure the fundamental signal level, and enter that level as an offset. Then, enter a frequency step size equal to the fundamental frequency. Now you can quickly step to the harmonic frequencies and measure the harmonic distortion directly without time-consuming calculations. When the exact fundamental frequency is unknown, the built-in counter can be used to measure the fundamental frequency, thereby ensuring precise tuning and accurate measurement.

Intermodulation distortion can also be measured quickly by storing the intermod frequencies and front panel settings in the non-volatile storage registers of the 3586C.

Verifying the total harmonic distortion specifications of sources and amplifiers is a laborious measurement unless a special purpose distortion analyzer is used. With a simple routine in a controller such as the HP 85F Personal Computer, the HP 3586C can be used to quickly measure total harmonic distortion as well as individual harmonic levels.

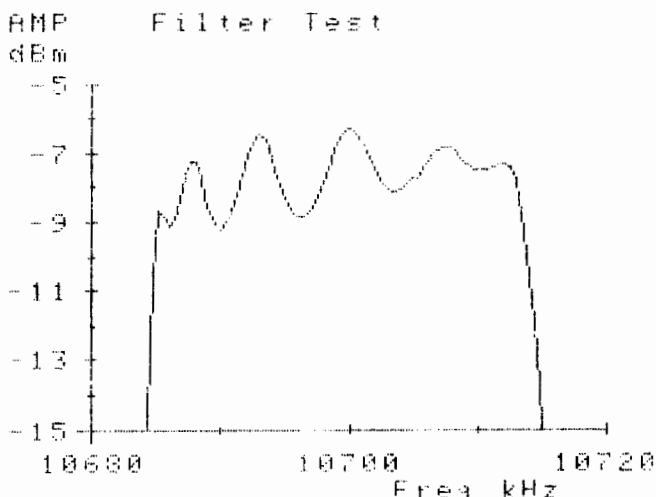

This bandpass filter was characterized using a 3586C and an HP 85F computer. By expanding the y-axis to cover only 10 dB, the passband ripple and 3 dB points are easy to identify.

Frequency Response Measurements

The 3586C includes a rear panel tracking output of approximately 0 dBm amplitude and ± 5 dB flatness at the same frequency as the passband center frequency. The tracking output has the same accuracy, stability and resolution as the 3586C center frequency specifications. This means the tracking output can be used for frequency response testing of high-Q filters and other selective networks. External attenuators can be used to adjust the input and output levels of the device under test to acceptable ranges.

For applications requiring improved amplitude accuracy and flatness, full amplitude range control without external attenuators, or better signal purity, use the 3336C or 3335A tracking synthesizer in place of the 3586C tracking output. By automatically tracking the frequency of the 3586C, the tracking synthesizers improve the accuracy and flexibility of frequency response measurements without increasing the measurement time.

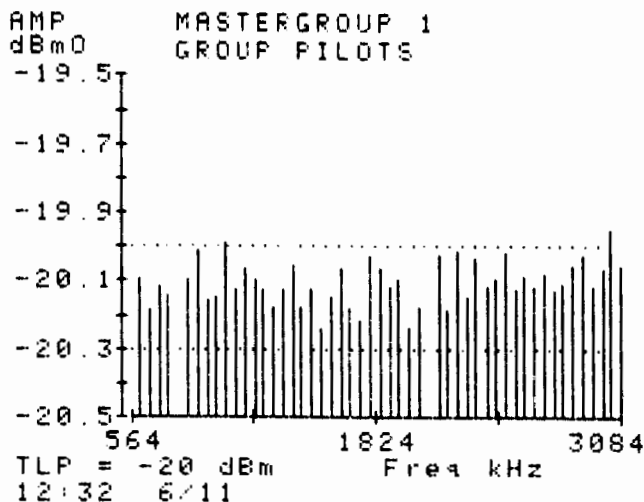

FDM NO.	FREQ	AMP
MG SG G CH	kHz	dBm0
> 1 13 1	-800.080	-20.75
> 1 14 1	-1048.080	-19.99
> 1 28 2	-3032.080	-19.95

In this group pilot test, all pilot levels are graphed and the out-of-tolerance pilots are additionally listed in tabular form.

Telecommunications Measurements

The HP 3586C can also be used for monitoring telecommunication systems. The 3586C can perform single sideband (SSB) voice channel measurements of pilot, carrier and tone levels. Idle channel noise and channel power measurements are made possible with the highly selective 3100 Hz filter. Single sideband AM channels can be demodulated for audio listening or for further measurements using additional equipment. In the wideband mode, the 3586C can be used for measuring the baseband power entering a microwave radio link.

With the addition of an HP computer, the 3586C can provide unattended, automatic surveillance of frequency multiplexed telemetry systems. Besides controlling the selective level meter, the computer can test for measurements that exceed user-defined limits.

The HP Models 3586A/B Selective Level Meters are designed specifically for North American Bell and CCITT Frequency Division Multiplex (FDM) measurements. Refer to page 624 for more information.



3586C Specifications

Frequency

Frequency range: 50/75 Ω Unbalanced Input; 50 Hz to 32.5 MHz, 600 Ω Balanced Input; 50 Hz to 100 kHz

Frequency resolution: 0.1 Hz

Center frequency accuracy: $\pm 1 \times 10^{-5}$ /year, ($\pm 2 \times 10^{-7}$ /year with option 004).

Counter accuracy: ± 1.0 Hz in addition to center frequency accuracy for signals within the 60 dB bandwidth of the IF filter chosen or greater than -100 dBm (largest signal is measured).

Frequency display: 9 digit LED

Selectivity

3 dB bandwidth: $\pm 10\%$: 20 Hz, 400 Hz, 3100 Hz

*Noise bandwidth is the same as the 3 dB bandwidth

60 dB bandwidth: 3100 Hz BW, ± 1850 Hz; 400 Hz BW, ± 1100 Hz; 20 Hz BW, ± 90 Hz

Adjacent channel rejection: 75 dB minimum at ± 2850 Hz, 3100 Hz BW

Passband flatness: ± 0.3 dB

Passband Flatness:

Bandwidth	Flatness Range	Flatness
3100 Hz	± 1000 Hz	± 0.3 dB
400 Hz	± 50 Hz	
20 Hz	± 3 Hz	

Amplitude

Measurement range: +20 to -120 dBm

Amplitude resolution: .01 dB

Level accuracy: 10 dB auto range, low distortion mode, after calibration, signal at ± 1 Hz from center frequency.

50/75 Ω inputs

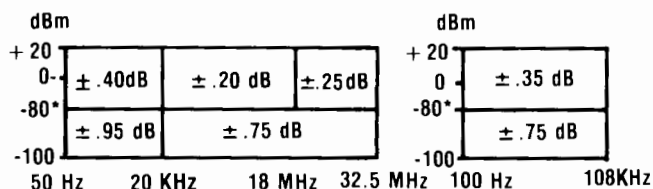

*20 Hz & 400 Hz BW below -90 dBm

Level accuracy: 100 dB Range (after calibration), add correction to 10 dB auto range accuracy for dB below full scale. (Not required when in 10 dB auto-range.)

dB Below Full Scale	Accuracy Correction
0 to -20 dB	$\pm .25$ dB
-20 to -40 dB	$\pm .50$ dB
-40 to -80 dB	± 2.0 dB

Wideband power accuracy: after calibration, 100 dB range, average on, -45 to +20 dBm.

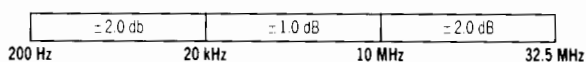

Dynamic Range

Spurious responses:

-115 dBm maximum or the following, whichever is greater.

Image rejection (100-132 MHz): -80 dBc

IF rejection: 15625 Hz, -80 dBc; 50 MHz, -60 dBc

Spurious signals: >1600 Hz offset, >-80 dBc; 300 Hz to 1600 Hz, >-75 dBc

Residual spurious: -110 dBm maximum; <350 Hz, -95 dBm

Distortion:

Harmonic distortion: -70 dB below full scale, low distortion mode, above 4 kHz.

Intermodulation distortion: -70 dB below full scale, 200 Hz to 20 kHz offset; -75 dB below full scale, 20 kHz to 1 MHz offset; -70 dB for either tone >10 MHz.

Noise floor (full scale setting -35 to -120 dBm):

Frequency	Bandwidth	Noise Level
100 kHz to 32.5 MHz	3100	-114 dBm
	20 Hz, 400 Hz	-120 dBm
2 kHz to 100 kHz	All	-105 dBm

The noise floor for full scale settings of -30 to +25 dBm will be 75 dB below full scale for >100 kHz, or 55 dB below full scale for <100 kHz.

Signal Inputs

Impedance	Frequency	Mating Connector
50/75 ohms unbalanced 600 ohms balanced	50 Hz to 32.5 MHz 50 Hz to 100 kHz	BNC Dual Banana Plug 0.75 inch Spacing

Return loss: 50/75 Ω , 30 dB; 600 Ω , 25 dB

Balance: 600 Ω ; 40 dB

Demodulated Audio Output

Output level: 0 dBm into a 600 Ω load

Output connector: 1/4" jack, mates with WECO 347.

Auxiliary Signal Inputs/Outputs

Tracking output: 0 dBm rear panel tracking output

Ext. reference input: 1 MHz to 10 MHz or sub-harmonic input.

Reference output: 10 MHz at 8 dBm output (also 10 MHz oven oscillator on instruments with option 004).

Probe power: front panel DC output for HP active high impedance accessory probes, (+15, -12 VDC)

HP-IB interface: rear panel interface meeting IEEE 488-1975 for remote operation. Used for tracking synthesizer interface.

Additional outputs: audio, phase jitter and meter output.

Options

Option 004: High stability frequency reference: 10 MHz oven stabilized reference oscillator, improves frequency stability to $\pm 2 \times 10^{-7}$ /year.

General

Operating Environment

Temperature: 0° to 55°C

Relative humidity: 95%, 0° to 40°C

Altitude: $\leq 15,000$ ft., ≤ 4600 metres

Storage environment temperature: -40°C to 75°C

Storage altitude: $\leq 50,000$ ft., $\leq 15,240$ metres

Power: 100/120/220/240 V, +5%, -10%, 48 to 66 Hz, 150 VA

Weight: 23 kg. (50 lbs.) net; 30 kg. (65 lbs.) shipping

Size: 177 mm H x 425.5 mm W x 475.5 mm D (7" x 16.75" x 16.75")

3586C Selective Level Meter*

\$9800

Opt 004: High Stability Frequency Reference add \$625

Opt 907: Front Panel Handles add \$40

Opt 908: Rack Flange Kit add \$30

Opt 909: Rack Flange & Handle Combination Kit add \$65

Accessories

1124A: High Impedance Probe

\$240

*HP-IB cables not supplied. See page 30.

SIGNAL ANALYZERS

Spectrum Analyzers, 100 Hz to 40 GHz

Models 8568A & 8566A

- 100 Hz to 1.5 GHz coverage with counter accuracy
- 10 Hz resolution bandwidth
- Trace markers with amplitude and frequency readout
- 100 Hz to 40 GHz coverage with synthesizer accuracy
- 2 to 22 GHz preselected range
- Comprehensive HP-IB capability

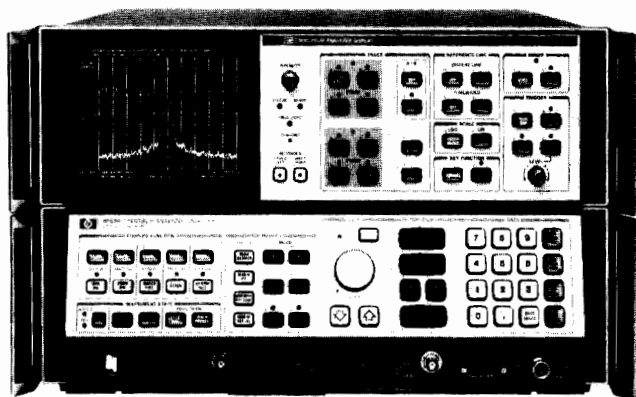

8568A

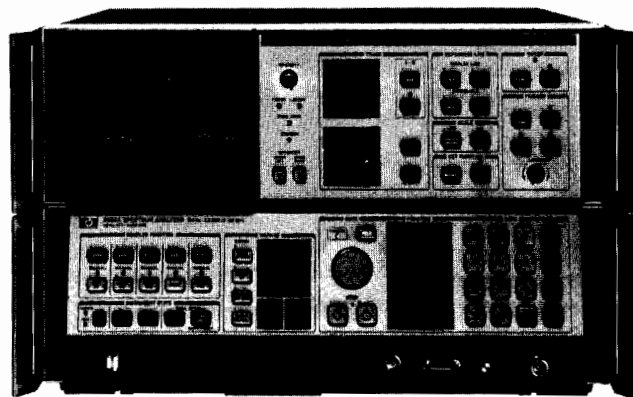

8566A



The 8568A and 8566A are high performance spectrum analyzers for bench and HP-IB system use. The 8568A operates over the 100 Hz to 1500 MHz frequency range, the 8566A operates over a 100 Hz to 22 GHz internal mixing range with preselection from 2 GHz to 22 GHz. The frequency range may be extended to 40 GHz with the HP11517A External Mixer and to 220 GHz using commercially available external mixers. (For more information, see Product Note 8566A-1). Each analyzer is designed around its own internal bus and controlled by its own microcomputer to yield significant improvements in RF measurement performance, new operational features, and unparalleled flexibility under program control.

The performance specifications for the 8568A and 8566A are described on pages 528 and 531.

Performance

Exceptional frequency stability in both the 8568A and 8566A enables the use of a 10 Hz resolution bandwidth over their respective frequency ranges. Superior spectral purity and narrow resolution make it possible to measure clean oscillators directly at RF frequencies. 10 Hz resolution also results in sensitivities to -135 dBm which makes greater than 85 dB spurious-free dynamic range achievable. A frequency reference error of 1×10^{-6} /day together with the analyzers' resolution and sensitivity allow small signals in the presence of large ones to be measured with unequalled accuracy.

Usability

All the control settings are conveniently read on the CRT display. The operator changes control settings through the data controls. To

activate a function the user pushes the appropriate key; he then has the option of setting the function's value using the knob, step keys or numeric/unit keyboard.

Measurements can be made following conventional "zoom" techniques using the center frequency, frequency span and reference level functions, or with the help of certain measurement aids. A preset button sets all analyzer controls to a convenient starting point; coupled functions, such as resolution bandwidth and sweptime change automatically as frequency span is reduced to maintain a calibrated display.

A tunable marker is available for directly measuring a signal or speeding the process of magnifying the portion of the spectrum to be analyzed. With the marker set to the signal peak, the signal's *amplitude* and *frequency* are displayed on the CRT. A second marker, useful for modulation or distortion measurements, makes relative measurements by displaying the difference in amplitude and frequency between the two markers. Marker information enables the operator to step between evenly spaced portions of the frequency spectrum such as communication channels or signal harmonics; the noise level at the marker can be converted to the RMS noise density normalized to a 1 Hz bandwidth. The marker may also be positioned at the peak of the largest signal on the screen and used to zoom-in on signals *automatically*.

Once the analyzer's controls have been adjusted, all settings can be *saved* in memory and later *recalled* to repeat the measurements. An internal battery maintains the contents of memory in the event of a power failure.

All displayed information resides in a digital memory from which the CRT is refreshed at a flicker-free rate. Display titles may be added. A trace may be viewed real-time or stored; max hold displays the

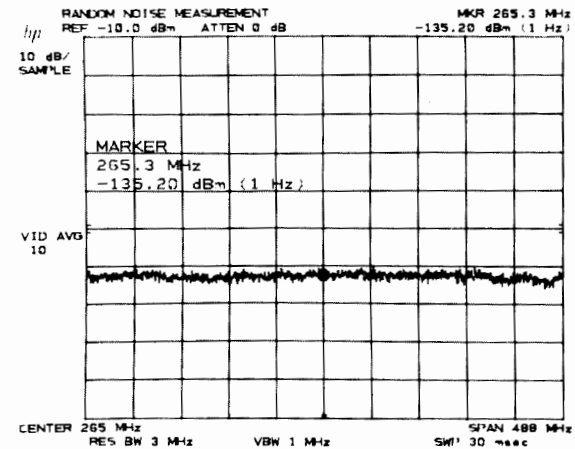
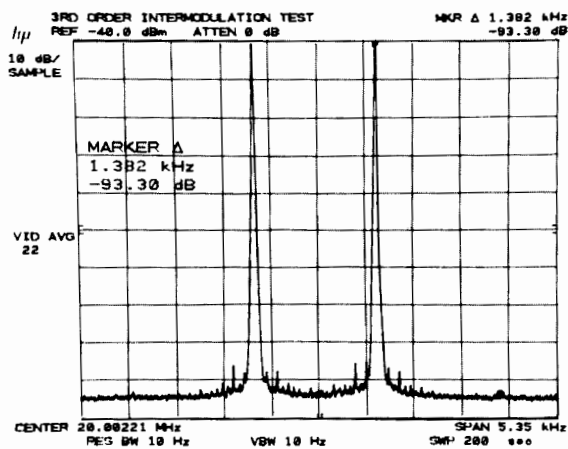
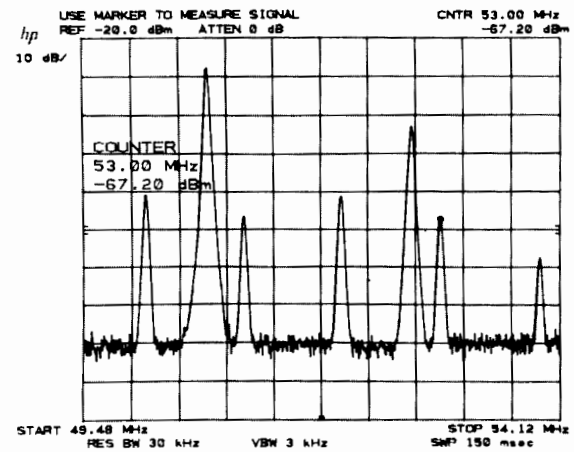
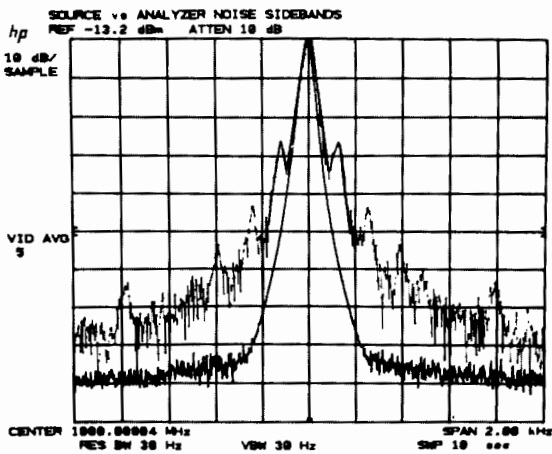
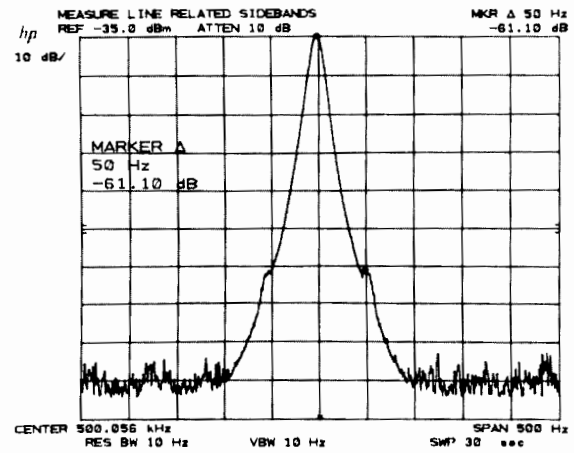
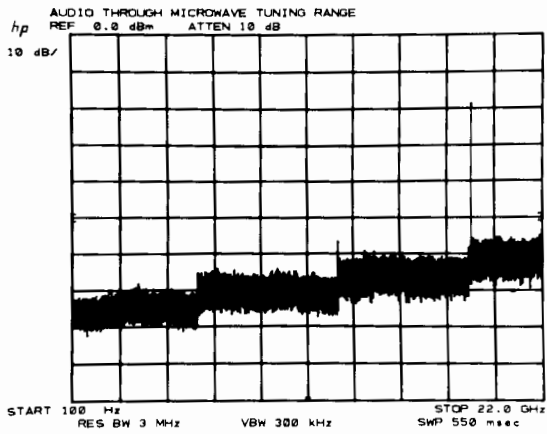

largest amplitude at 1001 points across the CRT over successive sweeps to aid in the measurement of residual FM or drift. Up to three traces may be observed simultaneously and arithmetic between traces or a trace and reference display line is possible for comparison or frequency response normalization.

Automatic Measurement Capability

The 8568A and 8566A analyzers lend themselves to automatic control via the HP Interface Bus (IEEE Standard 488-1975). The analyzers can be tuned with the precision of a synthesizer while retaining analog sweep and exceptional resolution. The analyzers' control architecture facilitates the remote operation of all function settings and the output of CRT trace information; the display itself is accessible for annotation and graphing purposes.

Friendly analyzer codes and HP-IB commands are used to program the analyzer; for example, CF 20 MZ instructs the analyzer to set center frequency to 20 MHz. Built-in firmware features such as

instrument preset, peak search and automatic zoom further simplify writing software.

The primary advantage of computer control is the execution of complicated or time consuming measurement routines with a minimum of involvement by the operator. This capability is especially useful in production line testing or unattended measurement situations such as spectrum monitoring. An analyzer may be joined by other instruments in a distributed system, or be controlled remotely through a data communications network. External control is desirable for setting the proper analyzer function values, reading data, performing any numerical manipulation required (including error correction), analyzing the results, and providing output data in a convenient format on a printer, plotter, or the analyzer CRT.

This automatic capability is available in two configured systems, the 8581B and 8582B Automatic Spectrum Analyzers. These are specified on page 534.

SIGNAL ANALYZERS

Spectrum Analyzer, 100 Hz to 1500 MHz

Model 8568A

- 100 Hz to 1.5 GHz frequency range
- 10 Hz resolution bandwidth
- Frequency counter accuracy
- Digital display
- Tunable marker with amplitude and frequency readout
- Store and recall of control settings

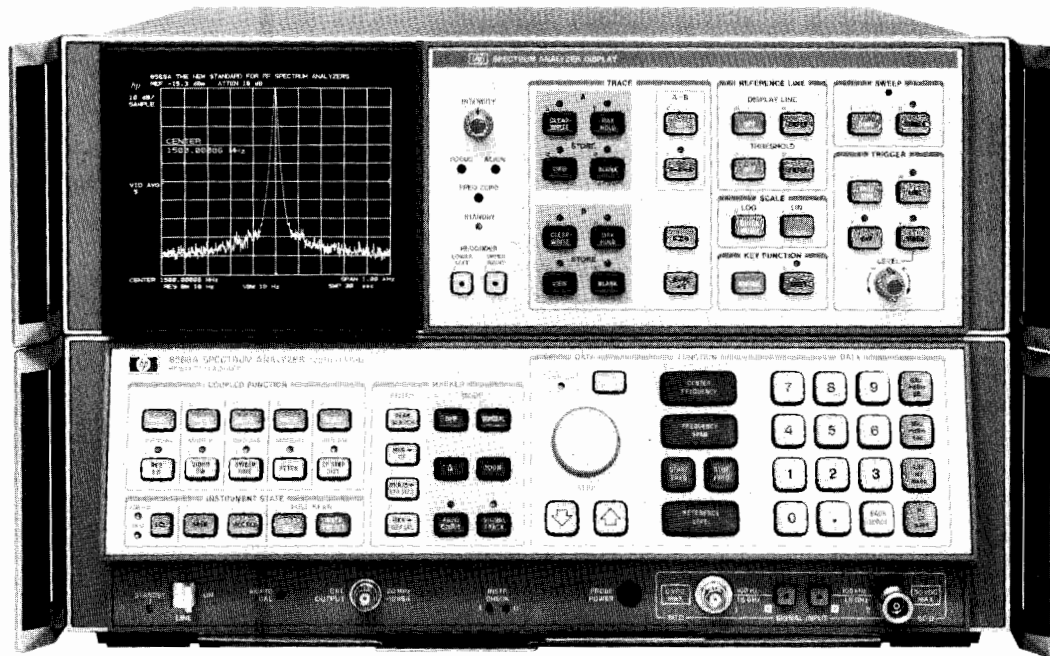

8568A



The 8568A Spectrum Analyzer is a high performance spectrum analyzer for bench and remote operation which covers the 100 Hz to 1.5 GHz frequency range. Frequency stabilized local oscillators and an internal counter bring unequalled measurement precision to RF spectrum analysis. Exceptional frequency stability and local oscillator spectral purity enables the use of a 10 Hz resolution bandwidth to make difficult, close-in sideband measurements on RF signals.

An internal microprocessor opens new horizons of operator convenience features. Digital display, store and recall of control settings, automatic zoom-in and signal track functions are administered by powerful firmware within the 8568A, thus simplifying operation of the analyzer.

All 8568A functions are programmable via HP-IB (IEEE 488-1975). Programming is as straightforward as encoding the steps used in a manual measurement. Friendly programming codes and easily recognizable mnemonics facilitate learning the analyzer language.

8568A Specifications

Frequency

Displayed Range

Frequency span: 100 Hz to 1500 MHz over 10 division CRT horizontal axis. In zero span, the instrument is fixed tuned at the center frequency.

Full span (0–1500 MHz): is immediately executed with a 0–1.5 GHz or INSTR PRESET keys.

Frequency span accuracy: for spans >1 MHz, $\pm(2\%$ of the indicated frequency separation between two points $+0.5\%$ span); for span ≤ 1 MHz, $\pm(5\%$ of frequency separation $+0.5\%$ span).

Center frequency: 0 Hz to 1500 MHz. Center frequency step size may be set using the numeric keyboard or MKR/ Δ —STP SIZE key.

Readout accuracy: Span ≥ 100 Hz: $\pm(2\%$ of frequency span + frequency reference error \times tune frequency $+10$ Hz) in AUTO resolution bandwidth after adjusting freq zero at stabilized temperature, and using the error correction function, SHIFT W and SHIFT X.

Start-stop frequency: permissible values must be consistent with those for center frequency and frequency span. SHIFT O sets the analyzer start and stop frequencies equal to the frequencies of the two Δ markers.

Readout accuracy: center frequency accuracy $+ \frac{1}{2}$ frequency span accuracy.

Marker

Normal: displays the frequency at the horizontal position of the tunable marker.

Accuracy: center frequency accuracy + frequency span accuracy between the marker and center frequencies.

PEAK SEARCH positions the marker at the center of the largest signal response present on the display to within $\pm 10\%$ of resolution bandwidth. MKR \rightarrow CF sets the analyzer center frequency equal to the marker frequency; MKR/ Δ \rightarrow STP SIZE sets the center frequency step equal to the marker frequency.

Frequency count: displays the frequency signal on whose response the marker is positioned. The marker must be positioned at least 20 dB above the noise or the intersection of the signal with an adjacent signal and more than four divisions up from the bottom of the CRT.

Accuracy: for span ≤ 100 kHz: frequency reference error \times displayed frequency ± 2 counts. For span > 100 kHz but ≤ 1 MHz: freq. ref. error \times displayed frequency $\pm (10$ Hz $+ 2$ counts). For span > 1 MHz: $\pm (10$ kHz $+ 1$ count).

Frequency reference error: aging rate $< 1 \times 10^{-9}$ /day; temp stability $< 7 \times 10^{-9}$, 0° to 55° C.

Signal track: re-tunes the analyzer to place a signal identified by the marker at the center of the CRT and maintain its position. Useful when reducing frequency span to zoom-in on a signal; also keeps a drifting input signal centered.

Δ : displays the frequency difference between the stationary and tunable markers. Reference frequency need not be displayed.

Accuracy: same as frequency span accuracy; in the FREQ COUNT mode, twice the frequency count uncertainty plus drift during the period of the sweep (typically < 10 Hz/minute). MKR/ Δ \rightarrow STP SIZE sets the center frequency step size equal to the frequency difference between the markers. SHIFT O sets the



analyzer start stop frequencies equal to the frequencies of the two markers.

Zoom: makes it possible to reduce the frequency span about the marker (or signal in the signal track and freq count modes) using the step down key.

Resolution

Resolution bandwidth: 3 dB bandwidths of 10 Hz to 3 MHz in a 1, 3, 10 sequence. Bandwidth may be selected manually or coupled to frequency span.

Bandwidth accuracy: calibrated to: $\pm 10\%$, 1 MHz to 3 kHz; $\pm 20\%$, 1 kHz to 10 Hz, 3 MHz bandwidths.

Bandwidth selectivity: 60 dB/3 dB bandwidth ratio: $<15:1$, 3 MHz to 100 kHz; $<13:1$, 30 kHz to 10 kHz; $<11:1$, 3 kHz to 30 Hz. 60 dB points on 10 Hz bandwidth are separated by <100 Hz.

Stability

Residual FM: <3 Hz peak-to-peak ≤ 10 sec; span <100 kHz, resolution bandwidth ≤ 30 Hz, video bandwidth ≤ 30 Hz.

Drift: <10 Hz/minute of SWEPTIME after 1 hr. warmup at stabilized temperature, for frequency span ≤ 100 kHz. Spans >100 kHz but ≤ 1 MHz, <100 Hz/minute of SWEPTIME; >1 MHz, <300 kHz/minute of SWEPTIME.

Spectral Purity

Noise Sidebands: >80 dB below the peak of a CW signal at frequency offsets $\geq 30 \times$ resolution bandwidth setting, for resolution bandwidths ≤ 1 kHz.

Line related sidebands: >85 dB below the peak of a CW signal.

Amplitude

Measurement range: -135 dBm to $+30$ dBm.

Displayed Range

Scale: Over a 10 division CRT vertical axis with the Reference Level at the top graticule line.

Calibration

Log: 10 dB/div for 90 dB display from Reference Level.

5 dB/div for 50 dB display

2 dB/div for 20 dB display

1 dB/div for 10 dB display

expanded from
reference level

Linear:

10% of Reference Level/div when calibrated in voltage.

Fidelity:

Log:	Incremental	Cumulative
	± 0.1 dB/dB over 0 to 80 dB display	$\leq \pm 1.0$ dB max over 0 to 80 dB display, 20–30°C.
		$\leq \pm 1.5$ dB max over 0 to 90 dB display.

Linear: $\pm 3\%$ of Reference Level.

Reference Level

Range

Log:

$+60.0^1$ to -139.9 dBm or equivalent in dBmV, dB μ V, volts.

Linear:

228.6^1 volts to 0.22 μ volts full scale.

Accuracy: the sum of the following factors determines the accuracy of the reference level readout. Depending upon the measurement technique followed after calibration, various of these sources of uncertainty may not be applicable.

An internal error correction function calibrates and reduces the uncertainty introduced by analyzer control changes from the error calibration state (-7 dBm reference level, 1 dB/div scale, 10 dB RF attenuation, 1 MHz bandwidth) when SHIFT W is executed just prior to the signal measurement (i.e., at the same temperature) within the 20°–30° range.

Calibrator uncertainty: ± 0.2 dB.

Frequency response (Flatness) uncertainty: input #1: ± 1 dB, 100 Hz to 500 MHz; ± 1.5 dB 100 Hz to 1500 MHz; input #2: ± 1 dB, 100 kHz to 1500 MHz.

Amplitude temperature drift: at -10 dBm reference level with 10 dB input attenuation and 1 MHz resolution bandwidth, ± 0.05 dB/°C (eliminated by recalibration).

Input connector switching uncertainty: ± 0.5 dB when calibration and measurement do not use the same RF input.

Input attenuation switching uncertainty: ± 1.0 dB over 10 dB to 70 dB range.

Resolution bandwidth switching uncertainty: (referenced to 1 MHz bandwidth)—corrected (uncorrected)

Range	20–30°C	0–55°C
1 MHz to 30 Hz	± 0.1 dB (± 0.5 dB)	(± 2.0 dB)
10 Hz	± 0.1 dB (± 1.0 dB)	(± 4.0 dB)
3 MHz	± 0.1 dB (± 1.0 dB)	(± 2.0 dB)

Log scale switching uncertainty: ± 0.1 dB corrected (± 0.5 dB uncorrected).

IF Gain uncertainty: corrected (uncorrected). Assuming the internal calibration signal is used to calibrate the reference level at -10 dBm and the input attenuator is fixed at 10 dB, any changes in reference level in the following ranges will contribute IF gain uncertainty:

Range	20–30°C	0–55°C
0 dBm to -55.9 dBm	NA ² (± 0.6 dB)	(± 1.0 dB)
-56 dBm to -129.9 dBm	± 1.0 dB ³ (± 1.0 dB)	(± 1.5 dB)

Each 10 dB decrease (or increase) in the amount of input attenuation at the time of calibration and measurement will cause a corresponding 10 dB decrease (or increase) in the absolute reference level settings described above.

RF Gain uncertainty (due to 2nd LO shift): ± 0.1 dB corrected (± 1.0 dB uncorrected)

Error correction accuracy: (applicable when controls are change from the error calibration state if SHIFT W and SHIFT X are used): ± 0.4 dB.

Marker

Normal: displays the amplitude at the vertical position of the tunable marker.

Accuracy: equals the sum of calibrator uncertainty, reference level uncertainty, and scale fidelity between the reference level and marker position.

PEAK SEARCH positions the marker at the peak of the largest signal present on the display. MKR → REF LVL set the analyzer reference level equal to the marker amplitude. RMS noise density in a 1 Hz bandwidth is read out using SHIFT M, by sampling the displayed trace and arithmetically correcting for the analyzer envelope detector response, log shaping, and measurement bandwidth.

Δ : displays the amplitude difference between the stationary and tunable markers. Reference frequency need not be displayed.

Accuracy: equals the sum of scale fidelity and frequency between the two markers.

Reference Lines

Display line: movable horizontal line with amplitude readout.

Threshold: movable horizontal trace threshold with amplitude readout.

Accuracy: equals the sum of calibrator uncertainty, reference level uncertainty, and scale fidelity between the reference level and reference line.

Dynamic Range

Spurious responses: for a total signal power ≤ -40 dBm at the input mixer of the analyzer, all image and out-of-band mixing responses, harmonic and intermodulation distortion products are >75 dB below the total signal power for inputs 10 MHz to 1500 MHz; >70 dB below the total signal power for input signals 100 Hz to 10 MHz.

Video bandwidth: post detection low pass filter used to average.

Displayed noise: bandwidth variable from 1 Hz to 3 MHz in a 1, 3, 10 sequence. Video bandwidth may be selected manually or coupled to resolution bandwidth.

Digital video averaging: displays the sweep-to-sweep average of the trace over a specifiable number of sweeps with SHIFT G, video averaging is turned off with SHIFT H.

Gain compression: <0.5 dB for signal levels ≤ -10 dBm at the input mixer.

Sweep Trigger

Free run: sweep triggered by internal source.

Line: sweep triggered by power line frequency.

¹Maximum input must not exceed $+30$ dBm (damage level).

²Accounted for under Error Correction Accuracy.

³Correction only applies over the 0 dBm to -55.9 dBm range.



SIGNAL ANALYZERS

Spectrum Analyzer, 100 Hz to 1500 MHz Model 8568A (Cont'd.)

Video: sweep triggered by detected waveform of input signal at an adjustable level; signal must be ≥ 0.5 div peak-to-peak.

External: sweep triggered by rising edge of signal input to rear panel BNC connector; trigger source must be > 2.4 volt (5 volt max).

Continuous

Sequential sweeps initiated by the trigger: 20 msec full span to 1500 sec full span in 1, 1.5, 3, 5, 7.5, 10 sequence.

Accuracy: sweep time ≤ 100 sec, $\pm 10\%$; > 100 sec, $\pm 20\%$.

Zero frequency span: 1 μ sec full sweep (10 divisions) to 10 msec full sweep in 1, 2, 5 sequence; 20 msec full sweep to 1500 sec full sweep in 1, 1.5, 2, 3, 5, 7.5, 10 sequence.

Accuracy: same as continuous.

Sweep time may be set manually or automatically for the frequency span, resolution bandwidth and video bandwidth selected.

Single: single sweep armed on activation and initiated by trigger (sweep ≥ 20 msec only).

Display

Trace: A and B are two independent signal response memories each having 1001 horizontal data positions and vertical resolution of 0.1%. Memory contents are displayed on the CRT at a rate independent of the analyzer sweep time. Trace A is displayed brighter than trace B.

Clear/Write: clears memory contents when first activated, then writes the analyzer signal response into the memory each sweep and displays memory.

Max hold: retains in memory and displays the largest signal level occurring at each horizontal data position over the repetitive sweeps beginning at the time the function is activated.

View: stops writing into memory and displays memory without changing its contents.

Blank: stops writing into memory and blanks the trace while retaining the last response in memory.

Arithmetic

A-B-A: initially subtracts the stored memory contents of B from the current memory contents of A and writes the difference into A; this process continues as the A memory is updated at the sweep rate. To accomplish $A+B-A$ use SHIFT c.

A=B: exchanges A and B display memory contents.

B-DL-B: subtracts the amplitude of the display line from the memory contents of B and writes the difference into B.

A third signal response memory, C (also with a 1001 data positions), can be used for signal response storage. It is accessed indirectly by transferring memory contents between B and C.

B-C: SHIFT l.

B=C: SHIFT i.

View C: SHIFT j.

Blank C: SHIFT k.

Annotation

Title: allows the user to write characters into a specified area on the CRT by pushing SHIFT E and typing the keys next to the blue front panel characters and data numbers desired. Use BACK-SPACE for corrections.

Blank: SHIFT o blanks (SHIFT p unblanks) all CRT characters and control setting readouts. SHIFT m blanks (SHIFT n unblanks) the CRT graticule.

Input

RF Inputs

The standard instrument configuration is as follows:

Input #1: 100 Hz to 1500 MHz, 50 Ω , BNC connector (Fused); dc coupled.

Reflection coefficient: > 0.20 (1.5 SWR) to 500 MHz, < 0.33 (2.0 SWR) 500 MHz to 1500 MHz; ≥ 10 dB input attenuation.

Input #2: 100 kHz to 1500 MHz, 50 Ω , Type N connector; ac coupled.

Reflection coefficient: < 0.20 (1.5 SWR); ≥ 10 dB input attenuation.

LO emission: typically < -75 dBm (0 dB RF Atten).

Isolation: > 90 dB between inputs.

Also available: Input #1, 100 kHz to 1500 MHz, 75 Ω , BNC connector, ac coupled (Opt 001).

Maximum Input Level

AC: continuous power, +30 dBm (1 watt); 100 watts, 10 μ sec pulse into ≥ 50 dB attenuation.

DC: Input #1, 0 volts; Input #2, ± 50 volts.

Input attenuator: 70 dB range in 10 dB steps. Zero dB attenuation accessible only through numeric/unit keyboard. Attenuation may be selected manually or coupled to reference level to insure a -10 dBm input mixer drive level for full-screen signals; other mixer levels may be specified using SHIFT ' and entering the desired amplitude through the keyboard.

Accuracy: ± 0.10 dB over 10-70 dB range.

Output

Calibrator: 20 MHz ± 20 MHz x frequency reference error (1×10^{-8} /Day), -10 dBm ± 0.2 dB; 50 Ω .

Probe power: +15 V, -12.6 V; 150 mA max.

Auxiliary (rear panel; nominal values)

Display: X, Y and Z outputs for auxiliary CRT displays. X, Y: 1 volt full deflection; Z: 0 to 1 V intensity modulation, -1 V blank. BLANK output (TTL level > 2.4 V for blanking) compatible with most oscilloscopes.

Recorder

Horizontal sweep output (x axis): a voltage proportional to the horizontal sweep; 0 V for left edge to +10 V for right edge.

Video output (y axis): detected video output proportional to vertical deflection of CRT trace. Output increases 100 mV/div from 0 to 1 V.

Penlift output (z axis): 15 V blanking output during retrace.

21.4 MHz IF: a 50 Ω , 21.4 MHz output related to RF input to the analyzer. Output nominally -20 dBm for a signal at the reference level. Bandwidth controlled by the analyzer's resolution bandwidth setting.

1st LO: 2-3.7 GHz, $> +4$ dBm; 50 Ω output impedance.

Frequency reference: 10.000 MHz, 0 dBm; 50 Ω output impedance.

Instrument State Storage

Up to 6 complete sets of user-defined control settings may be stored and recalled by pressing SAVE or RECALL and the desired register number (1 to 6) from the keyboard. Instrument state information is retained in memory approximately 30 days in STANDBY mode or after line power is removed.

Remote Operation

The standard 8568A operates on the Hewlett-Packard Interface Bus (HP-IB). All analyzer control settings (with the exception of VIDEO TRIGGER LEVEL, FOCUS, ALIGN, INTENSITY, FREQ ZERO and AMPLD CAL) are remotely programmable. Function values, marker frequency/amplitude, and A/B traces may be output; CRT labels and graphics may be input. An HP-IB cable (not supplied) is required for remote operation.

General

Environmental

Temperature: operating 0 $^{\circ}$ C to 55 $^{\circ}$ C, storage -40° C to +75 $^{\circ}$ C.

Humidity: operating $< 95\%$ R.H., 0 $^{\circ}$ C to 40 $^{\circ}$ C except as noted.

EMI: 8568A conducted and radiated interference is within the requirements of CE03 and RE02 of MIL STD 461A, VDE 0871, and CISPR pub'n 11.

Power requirements: 50 to 60 Hz; 100, 120, 220 or 240 volts ($+5\%$, -10%); approximately 450 VA (40 VA in standby). 400 Hz operation is available as Opt 400.

Weight: total net, 45 kg (100 lb); Display/IF Section, 21 kg (46 lb); RF Section, 24 kg (54 lb). Shipping net, 72 kg (158 lb); Display/IF Section, 27 kg (60 lb); RF Section, 32 kg (70 lb); Manuals and Accessories, 13 kg (28 lb).

Size: 267 H x 425.5 W x 558.8 mm D (10.5" x 16.75" x 22").

Ordering Information

8568A Spectrum Analyzer	Price
Opt 001: 75 Ω (BNC), 100 kHz to 1500 MHz RF Input #1	add \$200
Opt 400: 400 Hz Power Line Frequency Operation	add \$400
Opt 908: Rack Flange Kit	add \$50
Opt 910: Extra Manual	add \$250
Opt 913: Rack Flange Kit to Mount Instruments With Handles	add \$62
Opt 650: Quasi-Peak Modification	add \$200

SIGNAL ANALYZERS

Spectrum Analyzer, 100 Hz to 40 GHz

Model 8566A

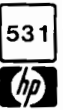

- 100 Hz to 22 GHz internal mixing range
- Synthesizer frequency accuracy
- 10 Hz frequency resolution

- Tunable marker with amplitude and frequency readout
- Integrated preselector with automatic peaking feature
- Store and recall of instrument settings

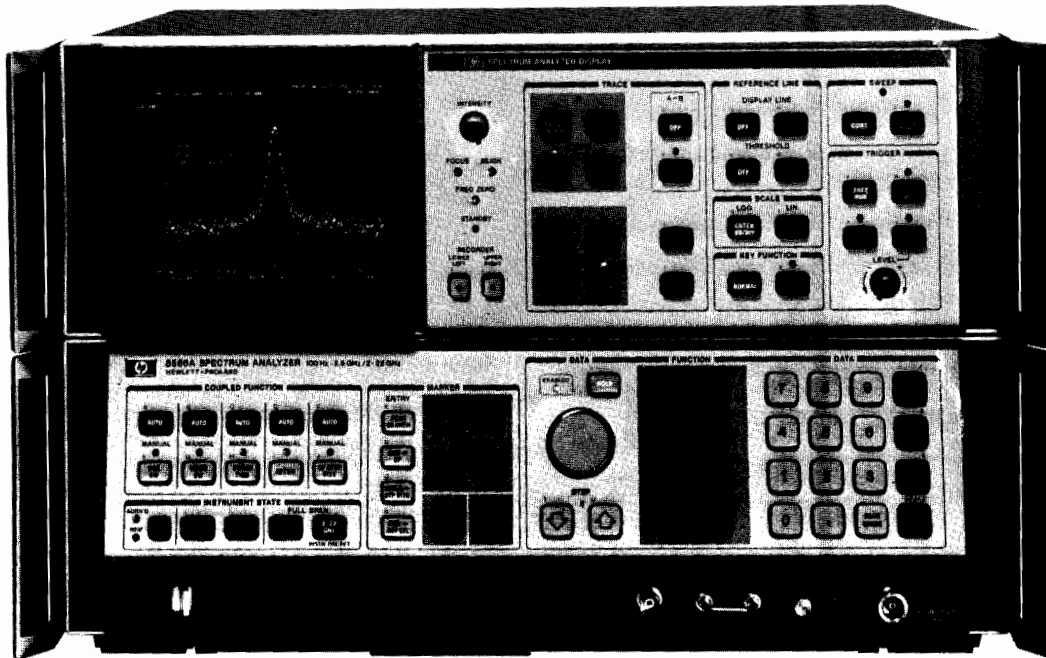

8566A



The 8566A Spectrum Analyzer is a high performance spectrum analyzer for bench and remote operation which operates from 100 Hz to 22 GHz using internal mixing. The frequency range may be extended to 40 GHz with the HP 11517A External Mixer and to 220 GHz with commercially available mixers. (For more information on external mixing, see Product Note 8566A-1). A synthesized local oscillator yields counter-like accuracy at microwave and millimeter wave frequencies. 10 Hz resolution bandwidth and superior frequency stability allow difficult measurements such as line-related side-band characterization at 22 GHz.

A unique integrated preselector/mixer provides high sensitivity with preselection from 2 GHz to 22 GHz. For example, in a 10 Hz resolution bandwidth, the sensitivity at 18 GHz is < -119 dBm.

8566A Specifications

Frequency

Measurement range: 100 Hz to 22 GHz with internal mixer, dc coupled input; 12.4 GHz to 40 GHz with HP 11517A External Mixer; 26.5 GHz to 220 GHz with commercially available external mixers.

Displayed Values

Center Frequency: 0 Hz to 300 GHz.

Readout accuracy: (AUTO resolution bandwidth after adjusting frequency zero at stabilized temperature, and using the error correction function, SHIFT W and SHIFT X) spans $\leq n \times 5$ MHz: $\pm(2\%$ of frequency span + frequency reference error \times center frequency + 10 Hz); spans $> n \times 5$ MHz: $\pm(2\%$ of frequency span + $n \times 100$ kHz + frequency reference error \times center frequency) where n is the harmonic number, depending on center frequency:

n	Center Frequency (internal mixing)
1	0 Hz to 5.8 GHz
2	5.8 GHz to 12.5 GHz
3	12.5 GHz to 18.6 GHz
4	18.6 GHz to 22 GHz (external mixing)
6	18.6 GHz to 26.5 GHz
8	26.3 GHz to 40.2 GHz

For center frequencies >40.2 GHz, refer to the Frequency Diagnostic (KSR) display for the value of n.

Frequency span: 0 Hz to 300 GHz over 10 division CRT horizontal axis; variable in approximately 1% increments.

Full span: 0 to 2.5 GHz and 2 to 22 GHz. 2 to 22 GHz is selected with INSTR PRESET.

Readout accuracy: spans $\leq n \times 5$ MHz, $\pm 1\%$ of indicated frequency separation; spans $> n \times 5$ MHz, $\pm 3\%$ of indicated frequency separation.

Start/Stop frequency: SHIFT O sets the analyzer start and stop frequencies equal to the frequencies of the two Δ markers.

Readout accuracy: Same as center frequency.

Frequency reference error: $< 1 \times 10^{-9}$ /day and $< 2 \times 10^{-7}$ /year.

Resolution

Resolution bandwidth: 3 dB bandwidths of 10 Hz to 3 MHz in a 1, 3, 10 sequence. Bandwidth may be selected manually or coupled to frequency span.

Bandwidth accuracy: calibrated to: $\pm 20\%$, 3 MHz to 10 Hz; $\pm 10\%$, 1 MHz to 3 kHz.

Bandwidth selectivity: 60 dB/3 dB bandwidth ratio: $< 15:1$, 3 MHz to 100 kHz; $< 13:1$, 30 kHz to 10 kHz; $< 11:1$, 3 kHz to 30 Hz. 60 dB points on 10 Hz bandwidth are separated by < 100 Hz.

Stability

Residual FM (typical): for fundamental mixing ($n = 1$); < 50 kHz peak-to-peak, frequency span ≥ 5 MHz; < 200 Hz peak-to-peak, frequency span ≤ 5 MHz; < 5 Hz peak-to-peak, frequency span < 100 kHz; < 0.2 Hz peak-to-peak, frequency span < 5 kHz.

Drift (typical): after 1 hour warm-up at stabilized temperature. COUPLED FUNCTION not required.

Frequency Span
 < 100 kHz
 100 kHz to 5 MHz
 ≥ 5 MHz

Center Frequency Drift
 < 10 Hz/minute of sweep time
 < 500 Hz/minute of sweep time
 < 5 kHz/minute of sweep time

Because the analyzer is phase locked at the beginning of each sweep, drift occurs only during the time of one sweep.

SIGNAL ANALYZERS

Spectrum Analyzer, 100 Hz to 40 GHz

Model 8566A (Cont'd.)

Spectral Purity

Noise sidebands: >85 dB below the peak of a 5.8 GHz CW signal at 1 kHz offset; >79 dB for 12.5 GHz signal; >75 dB for 18.6 GHz signal; >73 dB for 22 GHz signal; all for resolution bandwidth ≤ 100 Hz.

Power line related sidebands: >80 dB below the peak of a 5.8 GHz CW signal, <360 Hz offset.

Amplitude

Measurement Range: -134 dBm to +30 dBm.

Display Range

Scale: over a 10 division CRT vertical axis with the Reference Level at the top graticule line.

Calibration:

Log: 10 dB/div for 90 dB display from Reference Level.

5 dB/div for 50 dB display

2 dB/div for 20 dB display

1 dB/div for 10 dB display

expanded from
Reference Level

Linear: 10% of Reference Level/div when calibrated in voltage.

Fidelity

Log:

Incremental

± 0.1 dB/dB over
0 to 80 dB display

Cumulative

< ± 1.0 dB max over 0 to 80
dB display, 20-30°C.
< ± 1.5 dB max over 0 to 90
dB display.

Linear: $\pm 3\%$ of Reference Level

Reference Level

Range

Log: +30.0 to -99.9 dBm or equivalent in dBmV, dB μ V, Volts Readout expandable to +60.0¹ volts to -119.9 dBm (-139.9 dBm for <1 kHz resolution bandwidth) using SHIFT I.

Linear: 7.07 volts to 2.2 μ volts full scale. Readout expandable to 223.6¹ volts to 2.2 μ volts (0.22 μ volts for <1 kHz resolution bandwidth) using SHIFT I.

Accuracy: the sum of the following factors determines the accuracy of the reference level readout. Depending upon the measurement technique followed after calibration with the CAL signal, various of these sources of uncertainty may not be applicable. Specifications are with the preselector tracking optimized with MARKER PRESELECTOR PEAK function.

An internal error correction function calibrates and reduces the uncertainty introduced by analyzer control changes from the error calibration state (-7 dBm reference level, and 100 MHz center frequency) when SHIFT W and SHIFT X are executed just prior to the signal measurement (i.e. at the same temperature) within 20-30°C range.

Calibration uncertainty: ± 0.3 dB.

Frequency response (flatness) uncertainty: ± 0.6 dB, 100 Hz to 2.5 GHz; ± 1.7 dB, 2.0 GHz to 12.5 GHz; ± 2.2 dB, 12.5 GHz to 20 GHz; ± 3.0 dB, 20 GHz to 22 GHz; for 10 dB attenuator setting. Cumulative flatness ± 2.2 dB, 100 Hz to 20 GHz. COUPLED FUNCTION not required as long as display remains calibrated.

Absolute amplitude calibration uncertainty: ± 0.6 dB. The certainty of setting the frequency response curve absolutely when using the internal CAL signal or any other calibration signal in the 100 Hz to 2.5 GHz band.

Amplitude temperature drift: at -10 dBm reference level with 10 dB input attenuation and 1 MHz resolution bandwidth. ± 0.03 dB/°C (eliminated after recalibration).

Scale fidelity

Log:

Incremental

± 0.1 dB/dB

Cumulative

< ± 1.0 dB over 0 to 80 dB display
< ± 1.5 dB over 0 to 90 dB display

Linear: $\pm 3\%$ of reference level

Resolution bandwidth switching uncertainty²: referenced to 1 MHz bandwidth, corrected (uncorrected). ± 0.1 dB (± 0.5 dB), 30 Hz to 1 MHz bandwidths. ± 0.1 dB (± 1.0 dB, 10 Hz and 3 MHz bandwidths).

Log scale switching uncertainty: Corrected (uncorrected). ± 0.1 dB (± 0.5 dB).

IF gain uncertainty: Corrected (uncorrected). Assuming the internal calibration signal is used to calibrate the reference level at -10 dBm and the input attenuator is fixed at 10 dB, any changes

to the reference level function value from -10 dBm will contribute IF gain uncertainty.

Range

0 dBm to -55.9 dBm

-55.0 dBm to -129.9 dBm

Uncertainty

0 dB (± 0.6 dB)

± 1.0 dB (± 1.5 dB)

The range values change with different input attenuator settings. Each 10 dB decrease (or increase, in the amount of input attenuation at the time of calibration and measurement will cause a corresponding 10 dB decrease (increase) in absolute reference level settings described above.

RF gain uncertainty: corrected (uncorrected) 0 dB (± 0.2 dB). The gain change between preselected and non-preselected bands.

Error correction: ± 0.4 dB

When the error correction function is used (SHIFT W and SHIFT X), amplitude uncertainty is introduced because additional IF gain is used to offset errors in the switching of resolution BW, amplitude scales and RF gain.

Dynamic Range

Spurious responses: (signals generated by the analyzer due to input signals). For signals < -40 dBm all harmonic and intermodulation distortion > 70 dB below input signal.

Second order harmonic distortion: for mixer levels ≤ -40 dBm: < -70 dBc, 100 Hz to 50 MHz; < -80 dBc, 50 MHz to 700 MHz; < -70 dBc, 700 MHz to 2.5 GHz. For mixer levels ≤ -10 dBm: < -100 dBc, 2 to 22 GHz.

Third order intermodulation distortion: third order intercept (TOI): > +7 dBm, 100 Hz to 5.8 GHz; > +5 dBm, 5.8 to 18.6 GHz; > +5 dBm (typical), 18.6 GHz to 22 GHz; > +50 dBm (typical), 2 to 22 GHz for > 100 MHz signal separation.

Image responses: (due to input signals 642.8 MHz above or below the tuned frequency) < -70 dBc, 100 Hz to 18.6 GHz; < -60 dBc, 18.6 GHz to 22 GHz.

Multiple responses: (due to the input signal mixing with more than one local oscillator harmonic) < -70 dBc, 100 Hz to 22 GHz.

Out-of-band responses: (due to input signals outside the preselector's frequency span) < -60 dBc, 2 to 22 GHz.

Synthesis related spurious sidebands: < -90 dBc.

Residual responses: (signals displayed by the analyzer independent of input signals) With 0 dB input attenuation and no input signal: < -100 dBm, 100 Hz to 5.8 GHz; < -95 dBm, 5.8 GHz to 12.5 GHz; < -85 dBm, 12.5 GHz to 18.6 GHz; < -80 dBm, 18.6 GHz to 22 GHz.

Gain compression: < 1.0 dB, 100 Hz to 22 GHz with ≤ -5 dBm at input mixer.

Average noise level: with 0 dB input attenuation and 10 Hz resolution bandwidth. < -95 dBm, 100 Hz to 50 kHz; < -112 dBm, 50 kHz to 1.0 MHz; < -134 dBm, 1.0 MHz to 2.5 GHz; < -132 dBm, 2.0 GHz to 5.8 GHz; < -125 dBm, 5.8 GHz to 12.5 GHz; < -119 dBm, 12.5 GHz to 18.6 GHz; < -114 dBm, 18.6 GHz to 22 GHz.

Video bandwidth: post detection low pass filter used to average displayed noise bandwidth variable from 1 Hz to 3 MHz in a 1,3,10 sequence. Video bandwidth may be selected manually or coupled to resolution bandwidth.

Digital video averaging: displays the sweep-to-sweep average of the trace over a specifiable number of sweeps with SHIFT G, video averaging is turned off with SHIFT H.

Reference Lines

Display line: movable horizontal line with amplitude readout.

Threshold: movable horizontal trace threshold with amplitude read-out.

Accuracy: equals the sum of calibrator uncertainty, and scale fidelity between the reference level and reference line.

Marker

The marker is a bright dot placed upon the display trace which is positioned horizontally by the DATA controls. The marker amplitude and frequency are read out continuously.

Frequency

Normal: displays the frequency at the horizontal position of the tunable marker. PEAK SEARCH positions the marker at the cen-

¹Maximum input must not exceed +30 dBm (damage level).

²Accounted for under Error Correction Accuracy.

³Correction only applies over the 0 dBm to -55.9 dBm range.



ter of the largest signal response present on the display to within $\pm 10\%$ of resolution bandwidth. Following peak search, SHIFT K moves marker to next higher trace maximum. Subsequent SHIFT K entries move marker to sequentially lower maxima. MKR—CF sets the analyzer center frequency equal to the marker frequency; MKR/ Δ —STP SIZE sets the center frequency step size equal to the marker frequency.

Accuracy: same as center frequency accuracy.

Signal track: re-tunes the analyzer to place a signal identified by the marker at the center of the CRT and maintain its position (provided the signal remains on-screen during the period of one sweep). Useful when reducing frequency span to zoom-in on a signal; also keeps a drifting input signal centered.

Δ : displays the frequency difference between the stationary and tunable markers. Reference frequency may be outside current frequency span accuracy. MKR/ Δ —STP SIZE sets the center frequency difference between the markers. SHIFT O sets the analyzer start and stop frequencies equal to the frequencies of the two markers.

Accuracy: same as frequency span accuracy.

Zoom: makes it possible to reduce the frequency span about the marker (or signal in the track mode) using the step down key.

Amplitude

Normal: displays the amplitude at the vertical position of the tunable marker. PEAK SEARCH positions the marker at the peak of the largest signal present on the display.

MKR—REF LVL sets the analyzer reference level equal to the marker amplitude. RMS noise density in a 1 Hz bandwidth is read out using SHIFT M, by sampling the displayed trace and arithmetically correcting for the analyzer detector response, log shaping, and measurement bandwidth.

Accuracy: same as reference level accuracy plus scale fidelity between the reference level and marker position.

Δ : displays the amplitude difference between the stationary and tunable marker. Reference frequency may be outside current frequency span.

Accuracy: same as frequency response uncertainty and scale fidelity between two markers.

Preselector peak: with the marker at the peak of a displayed input signal, preselector peak automatically adjusts preselector tracking for maximum response. SHIFT = resets the preselector tuning to the nominal factory preset condition. If the marker is not activated when preselector peak is used, a peak search will be exercised prior to preselector peaking.

Sweep

Trigger, continuous and single is the same as the 8568A, pages 529 and 530.

Sweptime

Zero frequency span

With digital storage: 20 msec full sweep to 1500 sec full sweep $n \sim 1\%$ increments.

Without digital storage: 1 μ sec full sweep to 10 msec in 1,2,5 sequence.

Marker (sweeps > 20 msec only)

Normal: displays time from beginning of sweep to marker position.

Δ : displays time difference between stationary and tunable marker.

Display

The display functions are the same as the 8568A, page 530.

Input

RF Input: 100 Hz to 22 GHz, precision female type N connector, dc coupled.

SWR (typical): 1.2, 100 Hz to 2.5 GHz; 1.5, 2 GHz to 5.8 GHz; 1.9, 5.8 GHz to 22 GHz; with 10 dB input attenuation.

LO emission (typical): < -80 dBm when preselected; < -90 dBm when not preselected.

Maximum input level

AC: +30 dBm (1 watt), continuous power, from 50 ohm source. Mixer protected by diode limiter, 100 Hz to 2.5 GHz. < 100 watts, 10 μ sec pulse with ≥ 50 dB RF attenuation (≤ 0 dBm peak to input mixer).

DC: < 100 mA current damage level.

Input attenuator: 70 dB steps. Zero dB attenuation accessible only through numeric/unit keyboard. Attenuation may be selected manually or coupled to reference level to insure a -10 dBm input mixer

drive level for full-screen signals; other mixer levels may be specified using SHIFT , and entering the desired amplitude through the keyboard.

Accuracy: ± 1.0 dB over 10–70 dB range.

IF Input

Maximum input level

AC: +10 dBm, continuous power, from 50 Ω source.

DC: 20 volts with rise time of < 1 volt/ μ sec.

Sensitivity: -30 dBm at 321.4 MHz produces full-scale CRT deflection ± 1.0 dB when KSU has been executed.

Output

Calibrator: 100 MHz \pm (frequency reference error). -10 dBm ± 0.3 dB, 50 Ω impedance.

Auxiliary

Auxiliary outputs are the same as the 8568A, page 530.

21.4 MHz IF (rear panel): a 50 Ω , 21.4 MHz output related to the RF input to the analyzer. In log scales, the IF output is logarithmically related to the RF input signal; in linear, the output is linearly related. The output is nominally -20 dBm for a signal at the reference level. Bandwidth is controlled by the analyzer's resolution bandwidth setting; amplitude controlled by the input attenuator, and IF step gain positions.

IF Output (front panel)

Maximum input level

AC: +10 dBm, continuous power, from 50 Ω source.

DC: 20 volts with rise time of < 1 volt/ μ sec.

1st LO Output (front panel): 2.3 to 6.2 GHz, $> +5$ dBm., 50 Ω output impedance.

Maximum input level: +27 dBm (0.5 watt) total power into 50 Ω impedance.

Frequency reference (rear panel): > -5 dBm, 50 Ω output impedance

Sweep plus tune output (rear panel): 10.000 MHz, 0 dBm; 50 Ω output impedance.

10 MHz output (rear panel): > -5 dBm, 50 Ω output impedance.

Sweep plus tune output (rear panel): -1.0 volt per GHz of tune frequency, > 10 k Ω load.

Accuracy: -1 V/GHz $\pm 2\%$ ± 10 mV.

Instrument State Storage

Up to 6 complete sets of user-defined control settings may be stored and recalled by pressing SAVE or RECALL and the desired register number (1 to 6) from the keyboard. Instrument state information is retained in memory indefinitely in STANDBY and approximately 30 days after line power is terminated.

Remote Operation

The standard 8566A operates on the Hewlett-Packard Interface Bus (HP-IB). All analyzer control settings (with the exception of VIDEO TRIGGER LEVEL, FOCUS, ALIGN, INTENSITY, FREQ ZERO and AMPLD CAL) are remotely programmable. Function values, marker frequency/amplitude, and A/B traces may be output; CRT labels and graphics may be input. An HP-IB cable (not supplied) is required for remote operation.

General

Environmental

Temperature: operating 0°C to 55°C, storage -40°C to $+75^\circ\text{C}$.

Humidity: operating $< 95\%$ R.H., 0°C to 40°C except as noted.

EMI: Conducted and radiated interference is within the requirements of CE03 and RE02 of MIL STD 461A, VDE 0871, and CISPR pub'n 11.

Power requirements: 50 to 60 Hz; 100, 120, 220, or 240 volts ($+5\%$, -10%); approximately 650 VA (40 VA in standby). 400 Hz operation is available as Opt 400.

Weight: total net 50 kg (112 lb); Display/IF Section, 21 kg (47 lb); RF Section, 24 kg (53 lb). Shipping, Display/IF Section 31 kg (69 lb); RF Section 39 kg (87 lb).

Size: 267 H \times 425.5 W \times 598.5 mm D (10.5" \times 16.75" \times 23.56").

Ordering information

	Price
8566A Spectrum Analyzer	\$54,500
Opt 400: 400 Hz Power Line Frequency Operation	add \$400
Opt 908: Rack Flange Kit	add \$50
Opt 910: Extra Manual	add \$250
Opt 913: Rack Flange Kit to Mount Instruments with Handles	add \$62
Opt 650: Quasi-Peak Modification	add \$200
11517A Opt E02: External Mixer Kit	add \$1660



SIGNAL ANALYZERS

Automatic Spectrum Analyzers, 100 Hz to 40 GHz

Models 8581B & 8582B

- Interactive front panel under program control
- Friendly programming codes and powerful firmware
- 9825T Desktop Computer
- Ease of operation via HP-IB
- Software PAC minimizes program development time

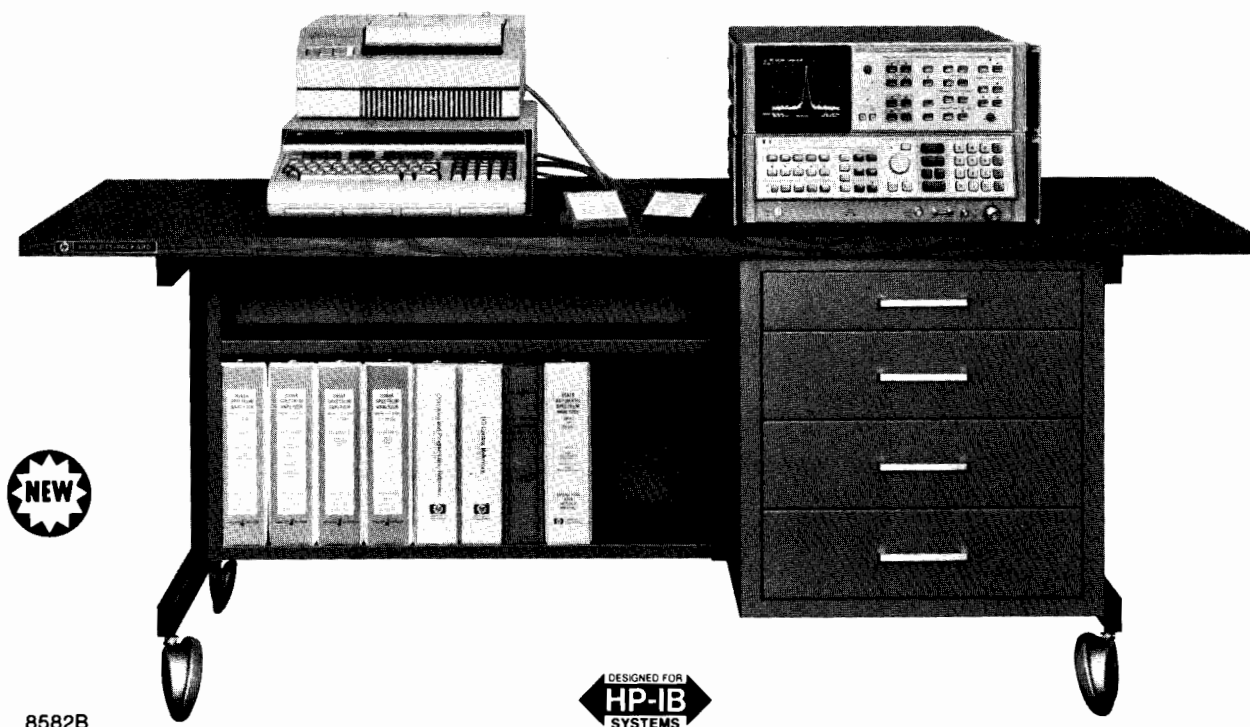

8582B



The 8581B and 8582B Automatic Spectrum Analyzers are systems based on the 8568A and 8566A spectrum analyzers respectively. Each system has the 9825T Desktop Computer with 62 k bytes of memory, the 9876A Printer with stand, a system software PAC, and a system table.

System Software

The system software provided with each system supplies high level software routines (subprograms) to aid the spectrum analyzer system programmer in developing programs. For the beginning programmers, the software PACs include sample measurement programs which can be run without previous programming experience.

Sample Measurement Programs

There are four sample programs to illustrate the speed and flexibility of the automatic spectrum analyzers. These programs make carefully controlled measurements of harmonic distortion, spectral content, percent amplitude modulation and noise/impulse bandwidths. The programs use accurate spectrum analyzer measurement techniques, while keeping careful bounds on the complexity of the signal to be measured in order to maintain the program's instructional value. Each measurement program is provided with complete operating instructions, a flow diagram and line-by-line annotation.

Subprogram Library

The system software includes subprogram modules which can be used by the more experienced programmer to extend the capability of the spectrum analyzer in an automatic environment. The sample programs described above illustrate the use of these subprograms.

One of these modules, called *PEAKS, is a subprogram that returns a list of the frequencies on the analyzer's trace at which there are peak signals as defined by the user.

Another subprogram, *OPT-RANGE, sets the spectrum analyzer's RF attenuator for the optimum dynamic range based upon the analyzer's current settings, the input signal power and upon either second or third order distortion criteria.

These subprograms are annotated on an operation and line-by-line basis.

Each software PAC includes two 9825 cartridges containing the sample measurement programs, subprograms, and utilities (including CRT plot and system checkout). Also included is a manual with annotated program listings. Complete compatibility requires 8568A or 8566A, 9825B or T, 9876A Option 025, and 98034B. For plotting CRT information: order 9872C and 10833B HP-IB cable.

Ordering Information

	Price
8581B Automatic Spectrum Analyzer (8568A based system)	\$51,900
8582B Automatic Spectrum Analyzer (8566A based system)	\$71,900

System Components

8568A Spectrum Analyzer or 8566A Spectrum Analyzer	
9825T Desktop Computer with 62k bytes of memory.	
9876A Opt 025 Thermal Printer	
98034B HP-IB Interface Card	
10833A HP-IB Cable	
88076A Computer Cradle	
System Table	
85860B Software PAC for 8568A/9825/9876A Opt 025/98034B	
85861B Software PAC for 8566A/9825/9876A Opt 025/98034B	
Factory Assembly and Checkout Prior to Shipment.	
Extra HP-IB cables not included.	

System Options and Software

Opt 002: Delete System Table	Less \$900
Opt 910: Extra Manual Set	\$500
Opt 650: Quasi-Peak Modification	\$200
85860A Software PAC for 8568A/9825/9866B Opt 025/98034A	\$250
85861A Software PAC for 8566A/9825/9866B Opt 025/98034A	\$250
85860B Software PAC for 8568A/9825/9876A/98034B	\$250
85861B Software PAC for 8566A/9825/9876A/98034B	\$250



- Quasi-peak detection for the 8566A and 8568A
- CISPR specified bandwidths
- Bypass made for regular spectrum analyzer operation

- Fully programmable via HP-IB
- Built-in speaker with volume control
- Auxiliary switches for accessories control

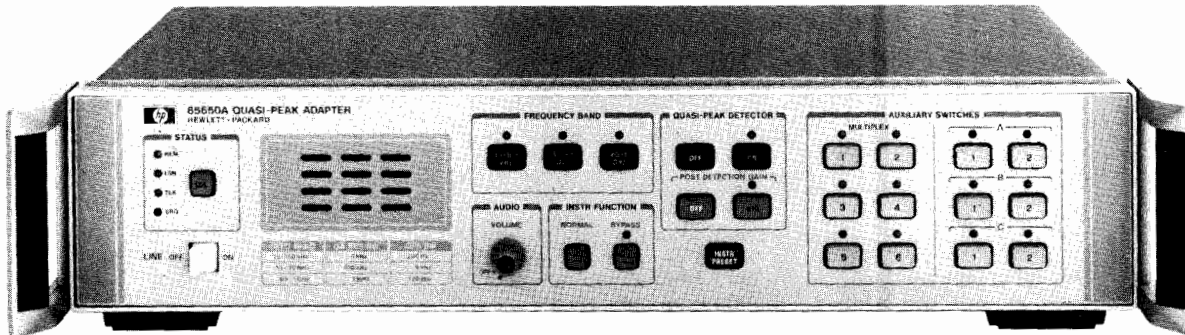

85650A



The 85650A Quasi-Peak Adapter is an accessory to the 8568A and 8566A Spectrum Analyzers. It adds to the spectrum analyzer the resolution bandwidth filters and quasi-peak detection capability specified by Publication 16 of the Comité International Spécial des Perturbations Radioélectriques (CISPR). Together, the quasi-peak adapter and spectrum analyzer provide many of the elements needed for an EMI receiver system. The 85650A is fully programmable via HP-IB, making automated measurements possible. A bypass switch is provided to enable the spectrum analyzer to bypass the quasi-peak adapter entirely and operate as a stand-alone instrument.

The CISPR pulse is given by:

$$(V\tau)_{\text{CISPR}} = 0.044 \mu\text{Vs for frequency range of 30-1000 MHz}$$

$$= 0.316 \mu\text{Vs for frequency range of 0.15-30 MHz}$$

$$= 13.5 \mu\text{Vs for frequency range of 10-150 kHz}$$

The pulsed RF signal must not cause gain compression and τ must be less than $1/(3 \text{ BW}_{\text{qp}})$ (BW_{qp} = the 6 dB resolution bandwidth specified by CISPR Publication 16.)

85650A Specifications

Fundamental Characteristics

Nominal values for fundamental quasi-peak characteristics are given in the following table:

Frequency Band (MHz)	Bandwidth at 6 dB (kHz)	Charge Time Constant (ms)	Discharge Time Constant (ms)	Display Time Constant (ms)
0.01-0.15	0.2	45	500	160
0.15-30	9	1	160	160
30-1000	120	1	550	100

Filter Selectivity

Response characteristics of the IF filter that determines the overall resolution of the system conform to the limits of overall selectivity given by CISPR Publication 16.

Pulse Response Characteristics¹

The quasi-peak response to a pulsed RF test signal of peak amplitude V and pulse width τ , will be given by:

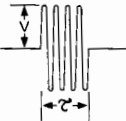

$$\text{Quasi-peak response to test pulse} = \text{Quasi-peak response to CISPR pulse} + 20 \log \frac{V\tau}{(V\tau)_{\text{CISPR}}}$$

Pulse Repetition Frequency (Hz)	Frequency Band		
	10 to 150 kHz	0.15 to 30 MHz	30 to 1000 MHz
1000	—	64.5 ± 2.5	68.0 ± 2.5
100	64.0 ± 2.5	60.0 ± 1.5	60.0 ± 1.5
60	63.0 ± 2.5	—	—
25	60.0 ± 1.5	—	—
20	—	53.5 ± 2.5	51.0 ± 2.5
10	56.0 ± 2.5	50.0 ± 3.0	46.0 ± 3.0
5	52.5 ± 3.0	—	—
2	47.0 ± 3.5	39.5 ± 3.5	34.0 ± 3.5
1	43.0 ± 3.5	37.5 ± 3.5	31.5 ± 3.5
Isolated Pulse	41.0 ± 3.5	36.5 ± 3.5	28.5 ± 3.5

General

Accessories Furnished

HP 10833D HP-IB Interconnection Cable 0.5m (1.6 Ft.)
Four HP 11170A Cable Assemblies, 30 cm (12 in.)
Front Panel Handles are included as standard.

Compatibility

Requires Option 650 for the HP 8566A or the HP 8568A Spectrum Analyzer.

As an alternative, HP Retrofit Modification Kit Part No. 85650-60050 is available to make the HP 8566A or HP 8568A compatible with the HP 85650A. For HP 8568A Display Sections prefixed 1745A or lower, additional modifications are required as explained in HP Service Note 8568A-40.

Environmental

Temperature: Operating 0°C to 55°C, storage -40°C to +75°C.

EMI

Conducted and radiated interference characteristics are in compliance with methods CE03 and RE02 of MIL-STD 461A, VDE 0871 Level B, and CISPR Publication 11.

Warm-up Time

Requires 10 minute warm-up from cold start, 0°C - 55°C.

Power Requirements

50 to 60 Hz; 100, 120, 220 or 240 volts (+5%, -10%); approximately 22 VA.

Weight

Net 10 kg (22 lb.). Shipping 15.5 kg (34 lb.).

Size

102.6 H × 425.5 W × 558.5 mm D (4.11" × 16.75" × 22").

Ordering Information

85650A Quasi-Peak Adapter

Opt 908: Rack Flange Kit for use with Handles Removed

Opt 910: Extra Manual

Opt 913: Rack Flange Kit for use with Handles Installed

Price

\$4000

20

10

20

¹This specification was derived by combining CISPR Publication 16 parts 2.1, "Amplitude relationship," and 2.2, "Variation with repetition frequency."

SIGNAL ANALYZERS

Microwave Spectrum Analyzer, 10 MHz to 40 GHz

Model 8569A

- 10 MHz to 22 GHz, external mixing to 170 GHz
- Simplified three knob operation
- Internal preselection, 1.7 to 22 GHz
- Wide resolution range, 100 Hz to 3 MHz
- Digital display of traces, control settings
- Unique HP-IB display interface

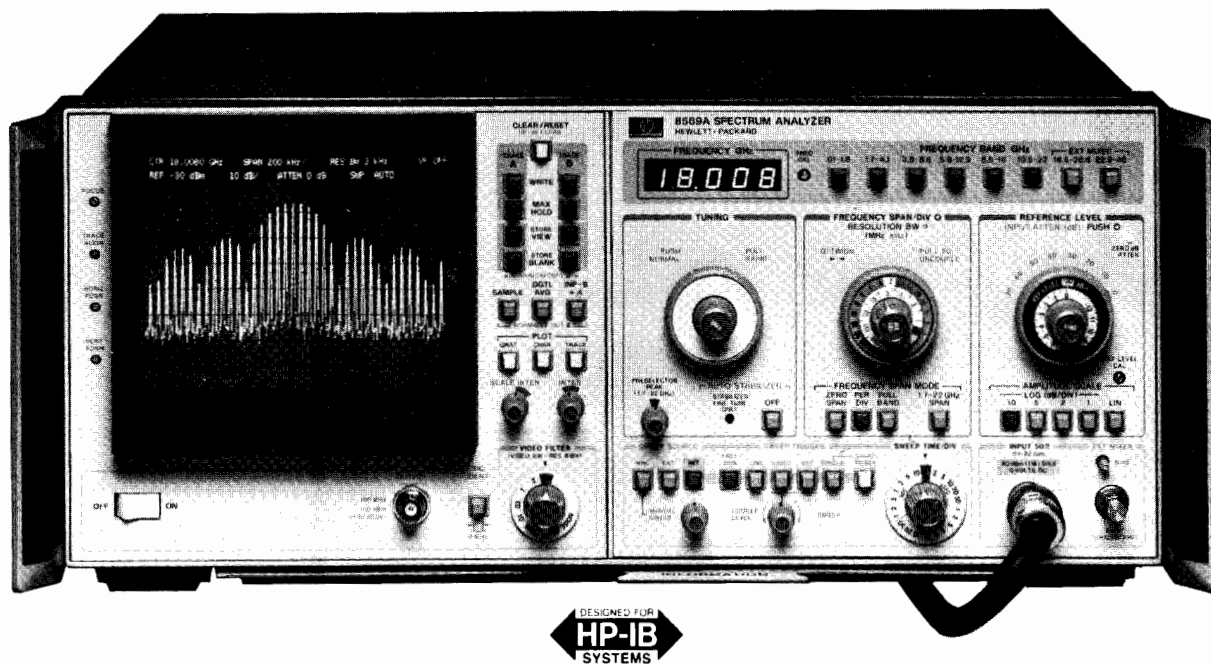

8569A Spectrum Analyzer

High performance and simple operation are combined with unique new microprocessor-controlled capabilities in the 8569A Microwave Spectrum Analyzer. Excellent sensitivity and internal preselection assure the wide, spurious-free measurement range necessary for production applications, while the digital display and coupled controls speed measurement routines. The internal frequency range of 10 MHz to 22 GHz is extendable to 40 GHz using the 11517A Opt. E03 External Mixer and to 170 GHz with other commercially available external mixers as described in Application Note 150-14. For semi-automatic operation, connect a desktop computer to the 8569A via HP-IB to allow access to the displayed trace data and the control settings necessary to analyze or record measurements, or display operator messages and prompts on the CRT. Direct, hard copy output to a digital plotter is possible without the need of a controller or programming.

Wide Range of Signal Resolution

Optimum resolution is possible for a wide range of signal characteristics with ten IF filters available from 100 Hz to 3 MHz. Fully automatic stabilization in narrow spans reduces residual FM to allow accurate measurements of closely spaced signals using the narrow bandwidths. The wide 1 and 3 MHz resolution bandwidths allow fast sweeps in wide spans and increased dynamic range for pulsed RF applications. All resolution filters are Gaussian-shaped for repeatable measurements, faster non-distortion sweep speeds, and best pulse response.

High Accuracy and Wide Dynamic Range

Absolute signal levels from -123 to $+30$ dBm are easily and accurately measured using IF substitution because the 8569A displays the reference level value directly on the CRT above the graticule. Damage to the mixer is prevented for signal levels of $+30$ dBm with a built-in limiter below 1.8 GHz and a preselector from 1.7 to 22 GHz. The internal preselector also assures maximum use of this wide measurement range by reducing internal distortion products as much as 120 dB. In addition, flat frequency response insures accuracy for relative as well as absolute power measurements.

Convenient Operation with Digital Display

Preset the 8569A to the color-coded, "basic operation," settings and use the coupled controls to make most measurements in three easy

steps: tune to the signal, select a span and raise it to the reference level. While in the AUTO sweeptime position, a calibrated amplitude display is insured. However, the microprocessor also monitors manually-selected sweeptimes and displays a warning if the sweep speed chosen is too fast for calibrated measurements. Signals are displayed on either of two independent digitally stored traces with all major control settings annotated above the graticule area. Display processing capabilities include Max Hold, digital averaging and trace normalization for extended measurement capability.

HP-IB Includes Direct Plotter Control

A hard-copy record of the displayed traces, control settings and graticule can be made on a digital plotter via HP-IB quickly and simply using the 8569A's front-panel pushbuttons without need for a controller. For maximum capability, attach a controller to the 8569A to read the trace data and control settings for a measurement analysis or recording on tape. Also, you can illustrate the test parameters for each measurement with display lines and instruct the operator with messages on the CRT. The controller can verify correct control settings before taking the test data or going on to the next step.

8444A Option 059 Tracking Generator

Characterize the frequency response of devices up to 1500 MHz by using the 8444A Option 059 Tracking Generator with the 8569A. Dynamic range is greater than 90 dB and system response errors can be removed using trace normalization. In addition, increase the analyzer's frequency accuracy to ± 10 kHz using a counter with the tracking generator. To configure a stimulus response system above 1500 MHz see Application Note 150-13.

8569A Specifications

Frequency Specifications

Frequency range: 0.01 to 22 GHz with internal mixer, 14.5 to 40 GHz with HP 11517A Opt. E03 External Mixer. Extendable to 170 GHz with commercially available mixers.

Tuning accuracy (digital frequency readout in any span mode)

Internal mixing, 0.01 to 22 GHz: $\pm(5$ MHz or 0.2% of center frequency, whichever is greater, $+20\%$ of Frequency Span/Div).

External mixing, 14.5 to 40 GHz: $\pm(0.7\%$ of center frequency $+20\%$ of Frequency Span/Div).



Frequency Spans

1.7 to 22 GHz: multiband span from 1.7 to 22 GHz in one sweep.

Full band: displays spectrum of entire band selected.

Per division: 1 kHz to 500 MHz/div in a 1, 2, 5 sequence.

Span width accuracy: $\pm 5\%$, 500 MHz to 20 kHz/div unstabilized; $\pm 15\%$, 100 kHz to 1 kHz/div, stabilized.

Zero span: analyzer becomes a manually tuned receiver.

Spectral Resolution and Stability

Resolution bandwidths: resolution (3 dB) bandwidths from 100 Hz to 3 MHz in 1, 3, sequence. Bandwidth and span width are independently variable or may be coupled for optimum display when control markers are aligned (▶◀).

Resolution bandwidth accuracy: 3 dB points are $\pm 15\%$.

Selectivity: (60 dB/3 dB bandwidth ratio): $<11:1$, 100 Hz to 1 kHz; $<15:1$, 3 kHz to 3 MHz.

Total residual FM: (fundamental mixing 0.01 to 4.1 GHz): <100 Hz p-p in 0.1 sec. First LO automatically stabilized for frequency spans ≤ 100 kHz/div.

Noise sidebands: >75 dB down, ≥ 30 kHz from signal in a 1 kHz Res. Bandwidth and a 10 Hz (0.01) Video Filter.

Amplitude Specifications

Amplitude Range—Internal Mixer

Total power: +30 dBm, +137 dB μ V (1 watt).

Damage levels: (50 ohm nominal source impedance):

dc: 0 V with 0 dB input attenuation (1 amp), ± 7 V with ≥ 10 dB input attenuation (0.14 amp).

Peak pulse power: +50 dBm (<10 μ sec pulse width, 0.01% duty cycle with ≥ 20 dB input attenuation).

Gain compression: <1 dB for -7 dBm signal, 0 dB input atten.

Average noise level: see table below for max. avg. noise level with 1 kHz Res. bandwidth (0 dB Atten. and 3 Hz video filter).

Frequency Band (GHz)	First IF in MHz	Harmonic Mode	Noise Level (dBm)	Frequency Response* (\pm dB max)
0.01-1.8	2050	1-	-113	1.2
1.7-4.1	321.4	1-	-110	1.5
3.8-8.5	321.4	2-	-107	2.5
5.8-12.9	321.4	3-	-100	2.5
8.5-18	321.4	4+	-95	3.0
10.5-22	321.4	5+	-90	4.5

*Frequency response includes input attenuator, preselector and mixer frequency response plus mixing mode gain variation (band to band).

Amplitude Range—HP 11517A Opt. E03 External Mixer

Measurement range: saturation (gain compression <1 dB), -15 dBm. Damage level >0 dBm or 0.1 erg static discharge.

Sensitivity: (Average noise level in a 10 kHz IF bandwidth): 14.5-18 GHz: <-80 dBm, 18-26.5 GHz: <-70 dBm, 26.5-40 GHz: <-60 dBm. Typical sensitivity is 10 dB better for each band.

Reference Level

Reference level range: +60 dBm (+30 dBm max. input) to -112 dBm in 10 dB steps and continuous 0 to -12 dB calibrated vernier.

Reference level accuracy: Auto Sweep setting of Sweep Time/Div control insures a calibrated display within these limits:

Calibrator output: (100 MHz ± 10 kHz): -10 dBm ± 0.3 dB.

Reference level variation: (input atten. at 0 dB): 10 dB steps $< \pm 0.5$ dB, -10 to -70 dBm); $< \pm 1.0$ dB, -10 to -100 dBm).

Vernier: (0 to -12 dB continuous); maximum error ± 0.5 dB.

Input attenuator: 0-70 dB in 10 dB steps.

Step size variation: ± 1.0 dB, 0.01 to 18 GHz; ± 1.5 dB, 0.01 to 22 GHz. Maximum cumulative error: ± 2.5 dB.

Frequency response: see table above.

Switching between bandwidths: 3 MHz to 100 Hz, ± 1.0 dB.

Calibrated Display Range

Log: 1, 2, 5, and 10 dB/div over 8 divisions.

Linear: 0.56 μ V to 224 V in 50 ohm.

Display accuracy

Log: ± 0.1 dB/8B: maximum cumulative error: ± 1.5 dB.

Linear: $< \pm 3\%$ over full 8 division deflection.

Residual responses: (no signal present at input): <-90 dBm.

Signal identifier: available over full tuning range.

Signal Input Characteristics

Input SWR (input impedance 50 ohm nominal)

Input atten. at 0 dB: <1.5 , 0.01-1.8 GHz; <2.0 , 1.7-22 GHz.

Input atten. at ≥ 10 dB: <1.3 , 0.01-1.8 GHz; <2.0 , 1.7-22 GHz.

LO Emission: (1.4 to 5.2 GHz): <-60 dBm, 0.01 to 1.8 GHz; <-80 dBm, 1.7 to 22 GHz.

Input protection: (for input signals from 0.01 to 22 GHz)

0.01 to 1.8 GHz: internal diode limiter.

1.7 to 22 GHz: preselector protects mixer to +30 dBm.

External mixer input: SMA female connector is a port for LO power transfer, bias current and IF return.

Sweep Specifications

Sweep Time

Auto: sweep time is automatically controlled by Frequency Span/Div, Resolution Bandwidth and Video Filter controls to maintain an absolute amplitude calibrated display.

Calibrated sweep times: 2 μ sec to 10 sec/div in 1, 2, 5 sequence.

Digital Display

Traces: dual trace, digitally stored display with a resolution of 481 horizontal by 801 vertical points for each trace.

Control readout: major control settings annotated on the CRT include Center or Marker frequency, Frequency Span/Div, Resolution BW, Video Filter, Reference Level, Scale Factor, RF Input Attenuator and Sweep Time/Div.

Signal processing: Max Hold, trace normalization, sample detection mode, digital avg. and dB μ V Reference Level readout.

Internal service routines: front-panel pushbuttons access test patterns to perform maintenance of digital hardware.

HP-IB

Direct plotter control: all displayed information can be transferred to an HP-IB plotter with front-panel pushbuttons.

Controller Interface Functions

Trace data transfer: all trace data values can be transferred to or from an 8569A with a controller.

Control readout: all displayed control settings can be transferred to a controller to check measurement conditions.

Input messages: controller-input instructions or annotation can be displayed within two 63 character lines on the CRT.

Sweep control: sweeps can be initiated and monitored.

Note: HP-IB cables are not supplied with the 8569A.

General Specifications

Temperature range: operating 0° to $+55^\circ$ C, storage -40° to $+75^\circ$ C.

Humidity range: (Operating): 95% R.H., 0° C to 40° C.

EMI: Conducted and radiated interference is in compliance with MIL-STD 461A Methods CE03 and RE02, CISPR Publication 11 (1975), and Messemphaenger-Postverfuegung 526/527/79 (Kennzeichnung Mit F-Nummer/Funkschutzzeichen).

Power requirements: 48-66 Hz, 100, 120, 220 or 240 volts (-10% to $+5\%$, 280 VA max (400 Hz operation available as Opt 400).

Size: 188 H x 426 W x 552 mm D (7" x 16.8" x 21.8").

Weight: net 29.2 kg (64 lb). Shipping 41 kg (90 lb).

Standard Options Available

Opt 001, Internal Comb Generator: 100 MHz comb signals visible through 22 GHz for increased frequency accuracy (error $<0.007\%$) and preselector peaking verification.

Opt 002, Delete 100, 300 Hz Bandwidths: standard specifications apply except minimum resolution bandwidth is 1 kHz with 15:1 shape factor, residual FM <200 Hz when stabilized.

Opt 400-400 Hz Power Supply.

Part No. 1450-0654—Transit Case: Order Part No. 1490-0913 also for castors.

Ordering Information

8569A Spectrum Analyzer \$26,500

Opt 001: Internal Comb Generator \$1,425

Opt 002: Delete 100, 300 Hz Bandwidths less \$800

Opt 400: Internal 50 to 400 Hz Power Supply \$350

Opt 908: Rack Flange Kit Without Handles \$30

Opt 910: Extra Operating & Service Manual \$50

Opt 913: Rack Flange Kit with Handles \$33

11517A Opt E03 External Mixer (taper sect. req'd) \$450

11518A: Taper Section, 12.4 to 18.0 GHz \$195

11519A: Taper Section, 18.0 to 26.5 GHz \$195

11520A: Taper Section, 26.5 to 40.0 GHz \$195

8444A Opt 059 Tracking Generator \$4,450

SIGNAL ANALYZERS

Spectrum Analyzer, 10 MHz to 40 GHz Model 8565A

- 0.01 to 22 GHz coverage with internal mixer
- Internal preselection 1.7 to 22 GHz
- Wide choice of resolution bandwidths
- Simple three knob operation
- Absolute amplitude calibration
- CRT bezel readout displays control settings

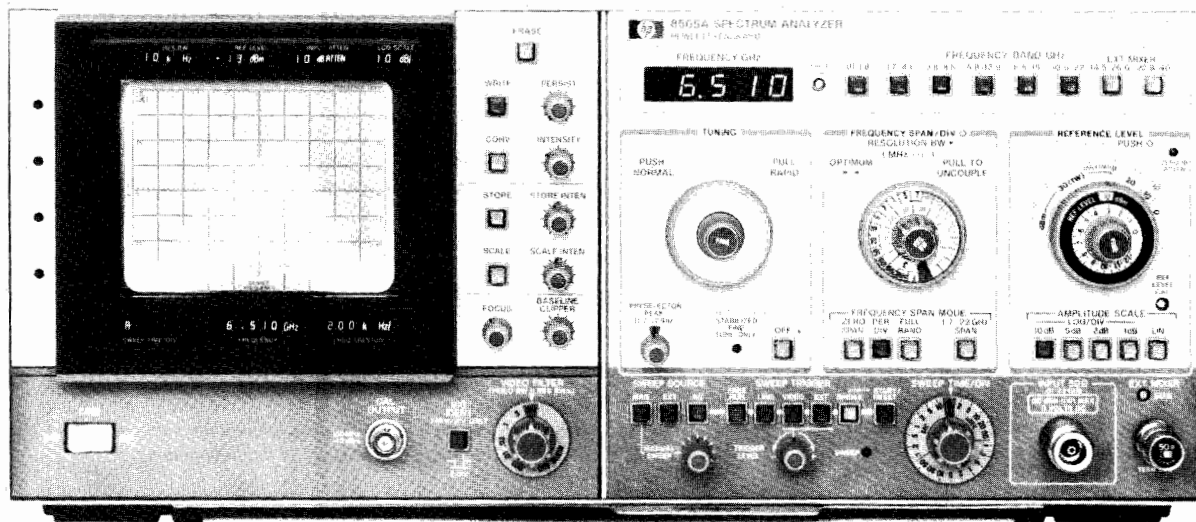

8565A Spectrum Analyzer

Covering from 0.01 to 22 GHz with its internal mixer, the 8565A has built-in preselection and brings accuracy plus convenience to microwave spectrum analysis. The wide range, spurious-free display, compact design and ease of use make it well suited for lab, production, or field applications requiring accurate measurement from IF thru microwave frequencies. The 8565A can cover 0.01 to 22 GHz in just two spans for rapid location of signals prior to close-in analysis in one of six bands. Coverage is easily extended up to 40 GHz with the HP 11517A External Mixer.

High Resolution

Fully automatic stabilization in narrow spans reduces residual FM and drift. Standard resolution bandwidths range from 1 kHz to 3 MHz. The 1 and 3 MHz bandwidths allow fast sweeps in wide spans and increased dynamic range for pulsed RF; the narrow bandwidths allow measurement of closely spaced signals. Option 100 provides additional 100 Hz and 300 Hz IF bandwidth filters, and residual FM is < 100 Hz when stabilized. This 100 Hz resolution is usable up to 8.5 GHz and the 300 Hz resolution bandwidth to 22 GHz. All resolution filters are gaussian-shaped for repeatable measurements, faster non-distorting sweeps and best pulse response.

Absolute Amplitude Calibration

Absolute signal levels from -112 dBm to +30 dBm are easily measured because the HP 8565A always displays the value of the reference line with LED's in the CRT bezel and at the reference level control. Changes in RF, IF gain, and preselector loss are automatically included. In addition, flat frequency response insures accuracy for relative as well as absolute power measurements.

Wide Dynamic Range

Internal preselection (1.7 to 22 GHz) enables you to measure distortion products as much as 100 dB down. Even for closely spaced signals or measurements below 1.7 GHz, all distortion products are greater than 70 dB down. In either case, maximum dynamic range is assured even for 1 watt signals with the 70 dB input attenuator. An input limiter (0.01 to 1.8 GHz) and the internal preselector (1.7 to 22 GHz) enable the 8565A to withstand RF signals up to +30 dBm for all input attenuator settings.

Designed for Convenience

Coupled controls allow you to make most measurements in 3 simple steps. Green color coded keys preset the 8565A for normal operation so a measurement only requires that you tune to a signal, select a desired span, and raise it to the reference level. Automatically select-

ed sweep times insure a calibrated display for all combinations of frequency span, resolution bandwidth and video filtering.

The CRT bezel LED's display all pertinent control settings to give you all the information needed for signal evaluations in one central location. These data are also captured in CRT photos.

8444A Option 059 Tracking Generator

Make swept frequency response measurements to ± 1.7 dB from 10 to 1300 MHz (± 2.7 dB up to 1500 MHz) with greater than 90 dB of dynamic range. The output is absolutely calibrated at 0 dBm and continuously variable to < -10 dBm. The frequency of unknown signals as well as the frequency of any point on the frequency response curve can be measured from the external counter output using the low-cost HP 5300/5305B Counter.

8750A Storage-Normalizer

The analyzer is made even easier to use with the digital storage of the 8750A because there is no need to re-adjust intensity or persistence as the sweep time changes. With the push of a button, a signal can be frozen on the CRT and then compared directly to the current input signal. Traces can also be compared arithmetically (i.e., normalized) to automatically remove frequency response variations. This is especially useful when used with the HP 8444A Opt. 059 Tracking Generator.

8565A Specifications

Frequency Specifications

Frequency range: 0.01 to 22 GHz with internal mixer, 14.5 to 40 GHz with HP 11517A External Mixer. Extendable to 170 GHz with commercially available mixers.

Tuning accuracy (digital frequency readout in any span mode)

Internal mixing: 0.01 to 2.5 GHz $< \pm (5 \text{ MHz} + 20\% \text{ of Frequency Span/Div.})$; 2.5 to 22 GHz $< \pm (0.2\% \text{ of center frequency} + 20\% \text{ of Frequency Span/Div.})$.

External mixing: 14.5 to 40 GHz $< \pm (0.7\% \text{ of center frequency} + 20\% \text{ of Frequency Span/Div.})$.

Frequency Spans

1.7 to 22 GHz: multiband span from 1.7 to 22 GHz in one sweep.

Full band: displays spectrum of entire band selected.

Per division: eighteen calibrated spans from 1 kHz per div. to 500 MHz per div. in a 1, 2, 5 sequence, plus a full band span, "F".

Span width accuracy: the frequency error for any two points on the display for spans from 500 MHz/div to 20 kHz/div (unstabilized) is less than $\pm 5\%$ of the indicated separation; for stabilized spans 100 kHz/div and less, the error is less than $\pm 15\%$.

Zero span: analyzer becomes a manually tuned receiver.



Spectral Resolution and Stability

Resolution bandwidths: resolution (3 dB) bandwidths from 1 kHz to 3 MHz in 1, 3 sequence. Bandwidth and span width are independently variable or may be coupled for optimum display when control markers are aligned (▶◀).

Resolution bandwidth accuracy: 3 dB points: $< \pm 15\%$.

Selectivity (60 dB/3 dB bandwidth ratio): $< 15:1$.

Stability: Total residual FM (fundamental mixing 0.01 to 4.1 GHz): stabilized, < 200 Hz p-p in 0.1 s; unstabilized < 10 kHz p-p in 0.1 s.

Stabilization range: first LO automatically stabilized for frequency spans 100 kHz/div or less. First LO residual FM typically 30 Hz p-p when stabilized.

Noise sidebands: > 70 dB down, > 30 kHz from center of CW signal in a 1 kHz Res. Bandwidth and a 10 Hz (0.01) Video Filter.

Amplitude Specifications

Amplitude Range – Internal Mixer

Measurement Range

Total power: +30 dBm (1 watt).

Damage levels: (50 Ω nominal source impedance.)

dc: 0 V with 0 dB input atten, ± 7 V with ≥ 10 dB input atten.

ac: 0 V with 0 dB input atten, 10 V peak with ≥ 10 dB input atten.

RF: (signals above 10 MHz) + 30 dBm for any attenuator setting.

Gain compression: < 1 dB for 0 dBm input level with 0 dB attenuation.

Average noise level: max. avg. noise level with 1 kHz Res. Bandwidth (0 dB atten and 3 Hz video filter) is in the table below:

Frequency Band (GHz)	First IF in MHz	Harmonic Mode	Noise Level (dBm)	Frequency Response* (\pm dB MAX)
0.01-1.8	2050	1-	-112	1.2
1.7-4.1	321.4	1-	-109	1.7
3.8-8.5	321.4	2-	-103	2.5
5.8-12.9	321.4	3-	-94	2.5
8.5-18	321.4	4+	-87	3.0
10.5-22	321.4	5+	-75	4.5

*Frequency response includes input attenuator, preselector and mixer frequency response plus mixing mode gain variation (band to band).

Amplitude Range - HP 11517A External Mixer

Measurement range: saturation (gain compression < 1 dB), -15 dBm. Damage level > 0 dBm or 0.1 erg static discharge.

Sensitivity (Average noise level in a 10 kHz IF bandwidth):

14.5–18 GHz < -80 dBm, 18–26.5 GHz < -70 dBm, 26.5–40 GHz < -60 dBm. Typical sensitivity is 10 dB better for each band.

> 40 GHz: for signal analysis above 40 GHz with commercially available mixers see Application Note 150-14.

Reference Level

Reference level range +70 dBm (+30 dBm max. input) to -102 dBm in 10 dB steps and continuous 0 to -12 dB calibrated vernier.

Reference level accuracy: the Auto Sweep setting of the sweep time/div control insures a calibrated display within these limits:

Calibrator output (100 MHz \pm 10 kHz): -10 dBm ± 0.3 dB.

Reference level variation (input attenuator at 0 dB): 10 dB steps $< \pm 0.5$ dB (0 to -70 dBm); $< \pm 1.0$ dB (0 to -90 dBm).

Vernier (0 to -12 dB) continuous: maximum error < 0.5 dB.

Input attenuator: (at preselector input, 0-70 dB in 10 dB steps).

Step size variation: $< \pm 1.0$ dB, 0.01 to 18 GHz; $< \pm 1.5$ dB, 0.01 to 22 GHz.

Maximum cumulative error over the 0 to 70 dB range: $< \pm 2.4$ dB, 0.01 to 18 GHz, 0 to 60 dB; $< \pm 2.5$ dB, 0.01 to 22 GHz, 0 to 40 dB.

Frequency response: see table above.

Switching between bandwidths: 3 MHz to 1 kHz, ± 1.0 dB

Calibrated Display Range

Log: (expanded from reference level down): 70 dB @ 10 dB/div, 40 dB @ 5 dB/div, 16 dB @ 2 dB/div and 8 dB @ 1 dB/div.

Linear: full scale from 1.8 μ V (-102 dBm in 50 Ω to 707 volts (+70 dBm) in 10 dB steps and continuous 0 to -12 dB vernier.

Display Accuracy

Log: $< \pm 0.1$ dB/dB, but $< \pm 1.5$ dB over full 70 dB display range.

Linear: $< \pm 3\%$ over full 8 division deflection.

Residual responses (no signal present at input): with 0 dB input atten, fundamental mixing (0.01 to 4.1 GHz) < -90 dBm.

Signal identifier: available over full tuning range and in all Freq. Span/Div settings for signal identification.

Signal Input Characteristics

Input impedance: 50 ohm nominal, 0.01 to 22 GHz.

Input connector: precision Type N female.

Input SWR

Input attenuator at 0 dB: < 1.5 , 0.01 to 1.8 GHz; < 2.0 , 1.7 to 22 GHz.

Input attenuator at ≥ 10 dB: < 1.3 , 0.01 to 1.8 GHz, < 2.0 , 1.7 to 22 GHz.

LO Emission (2.00 to 4.46 GHz): -50 dBm, 0.01 to 1.8 GHz; -85 dBm, 1.7 to 22 GHz.

Input protection (for input signals from 0.01 to 22 GHz)

0.01 to 1.8 GHz frequency band: internal diode limiter.

1.7 to 22 GHz frequency bands: saturation of YIG filter (pre-selector) occurs at total input signal power levels below input mixer damage.

External mixer input: BNC female connector is a port for LO power transfer, bias current and IF return.

Sweep Specifications

Sweep Time

Auto: sweep time is automatically controlled by Frequency Span/Div, Resolution Bandwidth and Video Filter controls to maintain an absolute amplitude calibrated display.

Calibrated sweep times: 21 internal sweep times from 2 μ s/div to 10 s/div in 1, 2, 5 sequence.

Display Characteristics

Cathode Ray Tube (aluminized P31 phosphor, 8 x 10 div internal graticule)

Persistence

Conventional: natural persistence of P31 phosphor.

Write: continuously adjustable from 0.2 s to full storage.

Storage time: continuously adjustable from 1 minute (full brightness) to > 30 minutes (minimum brightness).

Write speed: continuously adjustable to vary CRT sensitivity to capture large signal deflections in fast sweeps.

CRT Bezel readout: bezel LEDs display the following measurement data (included in CRT photographs taken with the HP 197B Opt 001, 006 Oscilloscope Camera): Ampl. Scale Factor, Ref. Level, Input Atten., Res. Bandwidth, Sweeptime/Div., Freq., Freq. Span/Div.

General Specifications

Temperature range: operating 0°C to 55°C, storage -40° to $+75^\circ$ C.

Humidity range (Operating): $< 95\%$ R.H. 0°C to 40°C.

EMI: Conducted and radiated interference is in compliance with MIL-STD 461A Methods CE03 and RE02, CISPR publication 11 (1975), and Messemphaenger-Postverfuegung 526/527/79 Kennzeichnung Mit F-Nummer/Funkschutzzeichen).

Power requirements: 48-66 Hz, 100, 120, 200 or 240 volts (-10% to $+5\%$) 220 V A max (400 Hz operation available as Opt 400).

Size: 188 H x 426 W x 552 mm D (7" x 16.8" x 21.8").

Weight: net 29.5 kg (64 lb). Shipping 39 kg (85 lb).

Standard Options Available

Opt 100, 100 and 300 Hz Resolution bandwidths: adds 100 Hz and 300 Hz resolution bandwidths with 11:1 shape factor, residual FM < 100 Hz when stabilized and improves sensitivity by 10 dB.

Opt 200—Calibration in dB μ V

Opt 400—400 Hz Power Supply

Part No. 1540-0654 - Transit Case. Order Part No. 1490-0913 also for castors.

Ordering Information

8565A Spectrum Analyzer

Price

\$23,700

Opt 100: 100 Hz and 300 Hz Resolution Bandwidths

add \$800

Opt 200: Calibration in dB μ V

add \$100

Opt 400: Internal 50 to 400 Hz Power Supply

add \$250

Opt 907: Front Handle Kit

add \$40

Opt 908: Rack Flange Kit

add \$30

Opt 909: Rack Flange and Front Handle Kit

add \$65

Opt 910: Extra Operating and Service Manual

add \$50

11517A External Mixer (taper section req'd)

\$300

11518A Taper Section, 12.4 to 18 GHz

\$195

11519A Taper Section, 18 to 26.5 GHz

\$195

11520A Taper Section, 26.5 to 40 GHz

\$195

8444A Opt 059 Tracking Generator, 10 to 1500 MHz

\$4,450

8750A Storage-Normalizer

\$1,750

SIGNAL ANALYZERS

Spectrum Analyzer, 0.01 to 350 MHz
Models 8557A/182T & 8750A

- Easy to operate
- Signal level displayed directly in dBm
- ± 2.25 dB amplitude accuracy

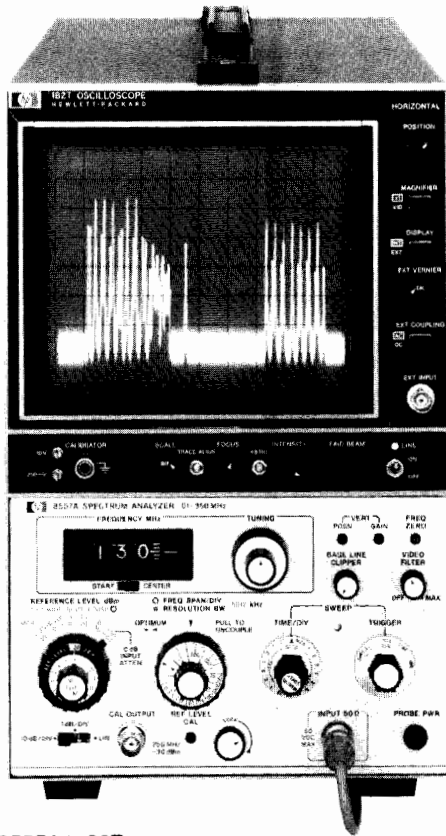

8557A/182T

8557A Spectrum Analyzer

Economy Plus Performance

The Model 8557A is a 0.01 to 350 MHz spectrum analyzer which plugs into any model 180-series oscilloscope display. This low cost, easy-to-use analyzer provides high accuracy in both amplitude and frequency measurements.

Simple, 3-knob Operation

Most measurements consist of three simple steps. Center the inverted marker under the signal to be measured; its frequency is displayed on the digital readout. Zoom-in on the signal by decreasing the frequency span; bandwidth, sweep time, and video filtering are set automatically. Raise the signal to the top of the CRT; read its amplitude (in dBm) from the reference level control.

Absolute Amplitude Calibration

Signal levels can be read directly from the CRT in dBm (dBmV for Option 002) without the use of external standards or calculations. The signal level represented by the top CRT graticule line is always indicated by the reference level control, and vertical scale factors of 10 dB/div, 1 dB/div, or linear can be selected.

Optional 75 Ohm Input

Two options are available which allow measurements in 75 ohm systems: Option 001 has 75 ohms impedance and retains the dBm power calibration; Option 002 is also 75 ohms, but the amplitude is calibrated in dBmV for measurements on systems such as CATV.

- Resolution bandwidths 1 kHz to 3 MHz
- Optional 75 Ω input with dBm or dBmV calibration
- Digital storage-normalizer available

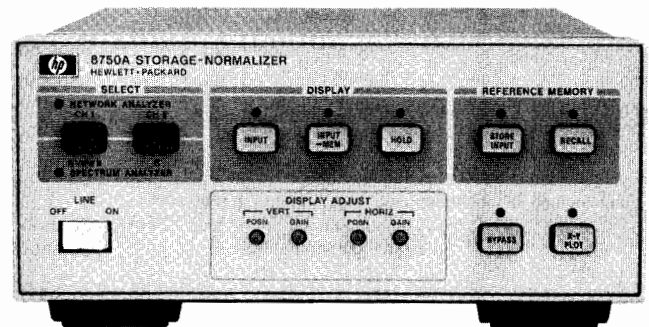

8750A

8750A Storage-Normalizer

The 8750A is an accessory which provides digital storage, trace comparison and normalization where data in memory is subtracted from current input and then displayed. In conjunction with the 182T display mainframe and the 8557A, the 8750A provides flicker-free display of measured signals. Additionally, two traces can be viewed from memory for CRT photography or detailed signal comparison.

Recommended Displays

The 8557A Spectrum Analyzer will function with any 180-series display. However, the following are recommended: for low cost, large screen display, the Model 182T is ideal; the Model 181T offers variable persistence and storage; the Model 180TR offers a rack mount configuration; and the Model 181TR offers variable persistence and storage in a rack mount configuration.

8557A Specifications

Frequency Specifications

Frequency range: 10 kHz to 350 MHz.

Frequency display span: (on a 10-division CRT horizontal axis): 12 calibrated spans from 20 MHz/div to 5 kHz/div in a 1, 2, 5 sequence. In "F" or full span the analyzer displays the full 10 kHz to 350 MHz. In "0" or zero span, the analyzer is a fixed-tuned receiver.

Accuracy: frequency error between any two points on the display is less than $\pm 10\%$ of the indicated frequency separation.

Digital frequency readout: indicates center frequency or start frequency of the frequency display span. In full span, the readout indicates the frequency at the marker with 100 kHz resolution.

Accuracy: (after zeroing on the LO feedthrough) ± 3 MHz + 10% of frequency span per division setting.

Stability

Residual FM: less than 1 kHz peak-to-peak for time ≤ 0.1 s (video filter full clockwise, but not in detent).

Noise sidebands: more than 75 dB below CW signal, 50 kHz or more away from signal with a 1 kHz resolution bandwidth and full video filtering.

Resolution

Bandwidth ranges: 3 dB resolution bandwidths of 1 kHz to 3 MHz in a 1, 3 sequence. Resolution bandwidth may be coupled to frequency span at a ratio of two display spans per resolution bandwidth.

Resolution bandwidth accuracy: individual resolution bandwidth 3 dB points calibrated to $\pm 20\%$. (10° - 40° C).

Resolution bandwidth selectivity: 60 dB/3 dB resolution bandwidth ratio $< 15:1$.



Video filter: post-detection low pass filter used to average displayed noise. Bandwidth variable from approximately 3X Resolution Bandwidth to approximately 0.01X Resolution Bandwidth. In the MAX position provides a noise averaging filter with a bandwidth of approximately 1.5Hz.

Amplitude Specifications

Measurement Range

Absolute measurement range: from -117 dBm to $+20$ dBm. Reference level settings in 10 dB steps, 0 to -12 dB continuous vernier.

Log display ranges: 10 dB/div on a 70 dB display and 1 dB/div on an 8 dB display.

Linear display: from 2.2 microvolts (-100 dBm) full-scale to 2.24 volts ($+20$ dBm) full-scale in 10 dB steps. Full-scale signals in linear translate to approximately full-scale signals in log.

Dynamic Range

Average noise level: < -107 dBm with a 10 kHz resolution bandwidth (0 dB input attenuation), 1–350MHz.

Spurious responses: for input signal level \leq Optimum Input Level setting, all image and out of band mixing responses, harmonic and inter-modulation distortion products are more than 70 dB below input signal level, 1 MHz to 350 MHz; 60 dB below, 20 kHz to 1 MHz.

Spurious responses due to 3rd order intermodulation distortion: for two input signals each at the Optimum Input setting, 3rd Order Intermodulation distortion products are more than 70 dB below the input signals, 1–350 MHz; 60 dB below, 10 kHz to 1 MHz (signal separation \geq 50 kHz).

Residual responses: (no signal present at input): < -100 dBm with 0 dB input attenuation, 0.1–350MHz.

Amplitude Accuracy

Frequency response (flatness): ± 0.75 dB.

Switching between bandwidths (at 10° – 40° C, 90% relative humidity):

3 MHz to 300 kHz: ± 0.5 dB.

3 MHz to 1 kHz: ± 1.0 dB.

Reference level accuracy (at fixed center frequency, fixed resolution bandwidth): ± 1.5 dB (includes input attenuator and IF gain accuracy. May be improved using IF or RF substitution techniques).

Amplitude log display: ± 0.1 dB/dB but no more than ± 1.5 dB over full 70 dB display range.

Calibrator

Amplitude: -30 dBm ± 1 dB.

Frequency: 250 MHz ± 50 kHz, crystal controlled.

Input attenuator: 50 dB range. Accuracy ± 0.5 dB per 10 dB step, but not more than ± 1.0 dB over full 50 dB range.

Input Specifications

Input connector: Type BNC female.

Input impedance: 50 Ω nominal. Typical reflection coefficient < 0.27 (1.74 SWR) for all Optimum Input Level settings except -40 dBm (0 dB Input Attenuation).

Maximum Input Levels

AC or peak: peak or average power $+20$ dBm (3.16 V ac peak or 0.1 W) incident on analyzer. (MAX input markings on front panel indicate maximum input allowable for < 1 dB gain compression or attenuator overload.)

DC: ± 30 V dc.

Output Characteristics

Cal output: -30 dBm, 250 MHz.

Probe power: $+15$ V, -12.6 V; 150 mA max. Powers 1120A, 1121A, 1123A, or 1124A high impedance probes.

Note: oscilloscope display rear panel outputs refer to 180T-series displays and 180-series Option 807 displays only. See below for information on modifying standard displays.

Vertical output: (AUX A on oscilloscope display rear panel): 0 to 0.8 V for 8-division deflection on CRT display; 50 Ω output impedance.

Pen lift/blanking output: (AUX B on oscilloscope display rear panel): 0 to 15 V (0 V, pen down). Approximately 10k Ω impedance when blanked. Compatible with HP 7004B, 7034B, 7005B, and 7035B X-Y Recorders.

21.4 MHz IF output: (AUX C on oscilloscope display rear panel): a 21.4 MHz output linearly related to the RF input to the analyzer. Bandwidth controlled by analyzer Resolution Bandwidth setting. Amplitude controlled by input attenuator, IF gain vernier, and first six IF step gain positions (-10 through -60 dBm Ref Level with 0 dB input attenuation). Output is approximately -10 dBm for full-scale signals on the CRT, 50 Ω output impedance.

Horizontal output (AUX D on oscilloscope display rear panel): -5.0 to $+5.0$ V for 10 div CRT deflection, 5k Ω output impedance.

Sweep Characteristics

Sweep Time

Auto: sweep time is automatically controlled by Frequency Span, Resolution Bandwidth, and Video Filter.

Manual: sweep determined by front panel control; continuously variable across CRT in either direction.

Calibrated sweep times: 16 internal sweep times from 0.1 ms/div to 10 sec/div in a 1, 2, 5 sequence. For sweep times of 2 ms/div to 10 sec/div, the analyzer is operable in its normal swept-frequency mode. Faster sweeps are useful for analyzing modulation waveforms when the analyzer is being operated as a fixed-tuned receiver with zero Display Span. Sweep times may be reduced to an effective 10 μ sec/div by using the 180-series X10 horizontal magnifier.

Accuracy: $\pm 10\%$.

Sweep Trigger

Video: sweep internally triggered by envelope of RF input signal (signal amplitude of 1.0 division peak-to-peak required on CRT display).

Line: sweep triggered by power line frequency.

Free run: sweep triggered repetitively by internally generated ramp.

Single: sweep triggered by front panel sweep trigger switch (spring return position).

General Characteristics

180 Series compatibility: the 8557A is compatible with all 180A/180AR, 180C, 180D, 180F, 181A, 181AR, 182A, 184A, and 184B mainframes. It is operable with the 183A, 183B mainframes, but the display is limited to 6 divisions by the 6-division CRT. The 180T series oscilloscope displays are recommended for use with the 8557A Spectrum Analyzer because they provide 4 nonbuffered rear panel auxiliary outputs (for unattenuated vertical, horizontal, and penlift outputs) and P39 medium-persistence CRT phosphor (except with 181T, 181TR which have P31 phosphor and provide variable persistence).

EMI: conducted and radiated interference is within requirements of methods CE03 and RE02 of MIL STD 461A, VDE 0871 Level B, CISPR Publication 11 (1975), and Postverfuegung 527/1979.

Power: (including oscilloscope display) 115 or 230 volts $\pm 10\%$, 48 to 440 Hz, less than 200 VA.

Weight

Model 8557A: net, 4.5 kg (10 lb). Shipping 5.4 kg (12 lb).

Model 182T: net, 12.3 kg (27 lb). Shipping 15.5 kg (34 lb).

Model 181T: net, 10.9 kg (24 lb). Shipping 15.5 kg (34 lb).

Model 180TR or 181TR: net, 11.8 kg (26 lb). Shipping 17.2 kg (38 lb).

Size

Model 182T (cabinet/large screen): 338.1 H x 201.6 W x 498.5 mm D (13.3" x 7.9" x 19.6").

Model 181T (cabinet/variable persistence): 289 H x 200 W x 530 mm D (11.4" x 7.9" x 21.3").

Model 180TR or 181TR (rack/standard and variable persistence): 133 H x 425 W x 543 mm D (5.2" x 16.8" x 21.4").

Ordering Information

	Price
8557A Spectrum Analyzer	\$5650
Opt 001: 75 ohm input (BNC), dBm calibration	add \$100
Opt 002: 75 ohm input (BNC), dBmV calibration	add \$100
Opt 910: Extra 8557A Manual	add \$19
182T Large Screen Display	\$2615
180TR Rack Mount Display	\$2760
181T Variable Persistence Display	\$3565
181TR Rack Mount 181T Display	\$3840
8750A Storage-Normalizer	\$1750

SIGNAL ANALYZERS

Spectrum Analyzer, 0.1 to 1500 MHz

Models 8558B/ 182T & 8444A Option 059

- Simple, 3-knob operation
- Display of signal levels directly in dBm
- Resolution bandwidths from 1 kHz to 3 MHz

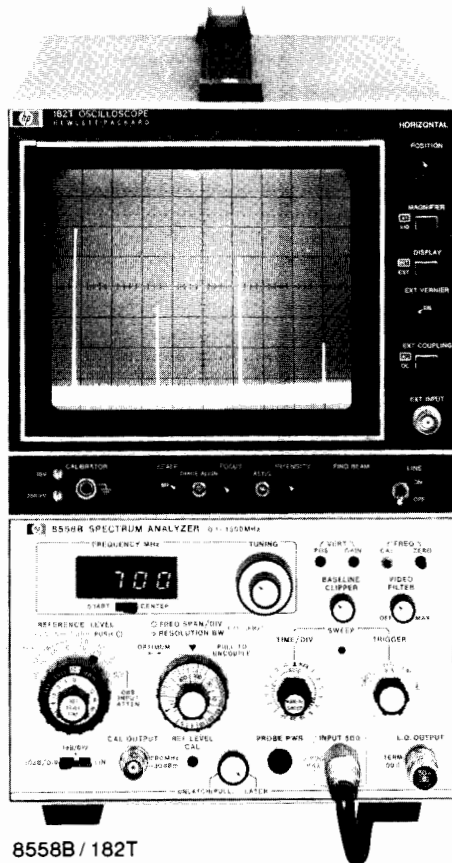

8558B/ 182T

8558B Spectrum Analyzer

Economical, Wide Frequency Coverage

The Model 8558B is a 0.1 to 1500 MHz spectrum analyzer which plugs into any 180-series oscilloscope display. It is fully calibrated in frequency and amplitude, easy to use, and provides an economical means for making measurements in the RF range.

Simple, 3-knob Operation

Most measurements consist of three simple steps. Tune to the signal to be measured; its frequency is displayed on the LED readout. Zoom-in on the signal by decreasing the frequency span; bandwidth, sweep time, and video filtering are set automatically. Raise the signal to the top of the CRT; read its amplitude (in dBm) from the reference level control.

Absolute Amplitude Calibration

Signal levels can be read directly from the CRT in dBm (dBmV for Option 002) without the use of external standards or calculations. The signal level represented by the top CRT graticule line is always indicated by the reference level control, and scale factors of 10 dB/div, 1 dB/div, and linear can be selected.

Optional 75 Ohm Input

Two options are available which allow measurements in 75 ohm systems: Option 001 has 75 ohms impedance and retains the dBm power calibration; Option 002 is also 75 ohms, but the amplitude is calibrated in dBmV for measurements on systems such as CATV.

- 0.5 to 1500 MHz tracking generator
- Digital storage-normalizer available
- Input protection



8444A Opt 059 (Compatible with 8558B)

8444A Option 059 Tracking Generator (0.5–1500 MHz)

Make swept frequency response measurements to ± 1.5 dB from 0.5 to 1300 MHz and ± 2.5 dB to 1500 MHz with greater than 90 dB of dynamic range. The output is absolutely calibrated at 0 dBm and continuously variable to -10 dBm. The frequency of unknown signals, as well as the frequency of any point on the frequency response curve, can be measured using the external counter output and Model 5300B/5305B Counter.

8750A Storage-Normalizer

The 8750A is an accessory which provides digital storage, trace comparison and swept response normalization. The frequency response variation of a swept measurement system, such as the 8558B and 8444A, can be removed through normalization. In addition, a "real time" signal can be compared with a stored trace or both traces can be viewed from memory for CRT photography or detailed comparison.

Recommended Displays

The 8558B Spectrum Analyzer will function with any 180-series display. However, the following are recommended: for low cost, large screen display, the Model 182T is ideal; the Model 181T offers variable persistence and storage; the Model 180TR offers a rack mount configuration; and the Model 181TR offers variable persistence and storage in a rack mount configuration.

8558B Specifications

Frequency Specifications

Frequency range: 100 kHz to 1500 MHz.

Frequency display span: (on a 10-division CRT horizontal axis): 14 calibrated spans from 100 MHz/div to 5 kHz/div in a 1, 2, 5 sequence. In "0" (zero span) the analyzer is a fixed-tuned receiver.

Accuracy: frequency error between any two points on the display is less than $\pm 5\%$ of the indicated frequency separation.

Digital frequency readout: indicates center frequency or start frequency of the frequency display scan. Two ranges: 0 to greater than 195 MHz with 100 kHz resolution; 195 MHz to 1500 MHz with 1 MHz resolution. ZERO control allows frequency readout to be adjusted for accurate calibration anywhere in the frequency range; CAL control removes frequency hysteresis. Resolution 100 kHz.

Accuracy: (after zeroing on the LO feedthrough and operation of the CAL button, 20° – 40° C).

0–195 MHz: ± 1 MHz $\pm 20\%$ of frequency span per division setting (≤ 1 MHz per division).

195–1500 MHz: ± 5 MHz $\pm 20\%$ of frequency span per division setting.

Stability

Residual FM: less than 1 kHz peak-to-peak for time ≤ 0.1 sec.

Noise sidebands: more than 65 dB below CW signal, 50 kHz or more away from signal with a 1 kHz resolution bandwidth and full video filter.

Resolution

Bandwidth ranges: 3 dB resolution bandwidths of 1 kHz to 3 MHz in a 1, 3 sequence. Resolution bandwidth may be coupled to frequency span at a ratio of two display spans per resolution bandwidth.

Resolution bandwidth accuracy: Individual resolution bandwidth 3 dB points calibrated to $\pm 20\%$, 10 – 40° C.

Resolution bandwidth selectivity: 60 dB/3 dB resolution bandwidth ratio $< 15:1$.



Video filter: post-detection filter used to average displayed noise. Bandwidth variable from approximately 3X Resolution Bandwidth to approximately 0.01X Resolution Bandwidth. In the MAX position provides a noise averaging filter with a bandwidth of approximately 1.5 Hz.

Amplitude Specifications

Measurement Range

Absolute measurement range: from -117 dBm to $+30$ dBm. Reference level settings in 10 dB steps, 0 to -12 dB continuous vernier.

Log display ranges: 10 dB/div on a 70 dB display, and 1 dB/div on an 8 dB display.

Linear display: from 2.2 microvolts (-100 dBm) full scale to 7.1 volts ($+30$ dBm) full-scale in 10 dB steps. Full-scale signals in linear translate to approximately full-scale signals in log.

Dynamic Range

Average noise level: < -107 dBm with a 10 kHz resolution bandwidth (0 dB input attenuation).

Spurious responses: for input signal level \leq Optimum Input Level setting, all image and out-of-band mixing responses, harmonic and intermodulation distortion products are more than 70 dB below input signal level, 5 MHz to 1500 MHz; 60 dB below, 100 kHz to 5 MHz.

Spurious responses due to 3rd order intermodulation distortion: for two input signals 10 dB above Optimum Input Level setting 3rd Order Intermodulation distortion products are >70 dB below the input signals, 5–1500 MHz; 60 dB below, 100 kHz to 5 MHz (signal separation ≥ 50 kHz).

Residual responses: (no signal present at input): < -100 dBm with 0 dB input attenuation, 1–1500 MHz.

Amplitude Accuracy

Frequency response (flatness): ± 1.0 dB.

Switching between bandwidths (at 10° – 40° C).

3 MHz to 300 kHz: ± 0.5 dB.

3 MHz to 1 kHz: ± 1.0 dB.

Reference level accuracy: (at fixed center frequency, fixed resolution bandwidth): ± 1.5 dB (includes input attenuator and IF gain accuracy). May be improved using IF or RF substitution techniques.

Amplitude log display: ± 0.1 dB/dB but not more than ± 1.5 dB over full 70 dB display range.

Calibrator

Amplitude: -30 dBm ± 1.0 dB.

Frequency: 280 MHz ± 30 kHz, crystal controlled.

Input attenuator: 70 dB range. Accuracy ± 0.5 dB per 10 dB step but not more than ± 1.0 dB over full 70 dB range.

Input Specifications

Input connector: type N female.

Input impedance: 50 Ω nominal. Typical reflection coefficient < 0.20 (1.5 SWR) for all Optimum Input Level settings except -40 dBm (0 dBm input attenuation).

Maximum Input Levels

Total average power: $+30$ dBm (1 watt, 10 Vac Peak) for any input attenuator setting.

Peak pulse power: $+50$ dBm (100 watts, 10 μ sec pulse width, Duty Cycle = 0.01), ≥ 10 dB optimum input setting.

DC: ± 50 V (to 100 Hz).

Output Characteristics

LO output: $+10$ dBm nominal, 50 ohms; 2.05–3.55 GHz.

Cal output: -30 dBm, 280 MHz.

Probe power: $+15$ V, -12.6 V; 150 mA max. Powers 1120A, 1121A, 1123A, or 1124A high impedance probes.

Note: the following oscilloscope display rear panel outputs refer to 182T, 180TR, 181T, 181TR displays and older 180-series displays with Option 807 only.

Vertical output: (AUX A on oscilloscope display rear panel.) 0 to 0.8 V for 8-division reflection on CRT display; 50 Ω output impedance.

Pen lift-blanking output: (AUX B on oscilloscope display rear panel): 0 to 15 V (0 V, pen down). Approximately 10 k Ω impedance when blanked. Compatible with HP 7004B, 7034B, 7005B, and 7035B X-Y Recorders.

21.4 MHz IF output: (AUX C on oscilloscope display rear panel): a 21.4 MHz output linearly related to the RF input to the analyzer. Bandwidth controlled by analyzer Resolution Bandwidth setting. Amplitude controlled by input attenuator, IF gain vernier, and first six IF step gain positions (-10 through -60 dBm Ref Level with 0 dB input attenuation). Output is approximately -10 dBm for full-scale signals on the CRT, 50 Ω output impedance.

Horizontal output: (AUX D on oscilloscope display rear panel): -5.0 to $+5.0$ V for 10 div CRT deflection, 5k Ω output impedance.

Sweep Characteristics

Sweep Time

Auto: sweep time is automatically controlled by Frequency Span, Resolution Bandwidth, and Video Filter.

Manual: sweep determined by front panel control, continuously variable across CRT in either direction.

Calibrated sweep time: 16 internal sweep times from 0.1 ms/div to 10 sec/div in a 1, 2, 5 sequence. For sweep times of 2 ms/div to 10 sec/div, the analyzer is operable in its normal swept frequency mode. Faster sweeps are useful for analyzing modulation waveforms when the analyzer is being operated as a fixed-tuned receiver with zero Display Span. Sweep times may be reduced to an effective 10 μ sec/div by using the 180-series X10 horizontal magnifier.

Accuracy: $\pm 10\%$.

Sweep Trigger

Video: sweep internally triggered by envelope of RF input signal (signal amplitude of 1.0 division peak-to-peak required on CRT display).

Line: sweep triggered by power line frequency.

Free run: sweep triggered repetitively by internally generated ramp.

Single: sweep triggered by front panel sweep trigger switch (spring return position).

General Characteristics

180 Series compatibility: the 8558B is compatible with all 180A, 180AR, 180C, 180D, 180F, 181A, 181AR, 182A, 184A, and 184B mainframes. It is operable with the 183A, 183B mainframes, but the display is limited to 6 divisions by the 6-division CRT. The 180T series oscilloscope displays are recommended for use with the 8558B Spectrum Analyzer because they provide 4 non-buffered rear panel auxiliary outputs (for unattenuated vertical, horizontal, and penlift outputs) and P39 medium-persistence CRT phosphor (except with 181T, 181TR which have P31 phosphor and provide variable persistence).

EMI: conducted and radiated interference is within requirements of methods CE03 and RE02 of MIL STD 461A, VDE 0871 Level B, CISPR Publication 11 (1975), and Postverfuegung 527/1979.

Power: (including oscilloscope display) 115 or 230 volts $\pm 10\%$, 48 to 440 Hz, less than 200 VA.

Weight

Model 8558B: net, 5.9 kg (13 lb). Shipping 6.8 kg (15 lb).

Model 182T: net, 12.3 kg (27 lb). Shipping 15.5 kg (34 lb).

Model 181T: net, 10.9 kg (24 lb). Shipping 15.5 kg (34 lb).

Model 180TR or 181TR: net, 11.8 kg (26 lb). Shipping 17.2 kg (38 lb).

Size

Model 182T (cabinet/large screen): 338.1 H x 201.6 W x 498.5 mm D (13.3" x 7.9" x 19.6").

Model 181T (cabinet/variable persistence): 289 H x 200 W x 530 mm D (11.4" x 7.9" x 21.3").

Model 180TR or 181TR (rack/standard and variable persistence): 133 H x 425 W x 543 mm D (5.2" x 16.8" x 21.4")

Ordering Information

	Price
8558B Spectrum Analyzer	\$7000
Opt 001: 75 ohm input (BNC), dBm calibration	add \$100
Opt 002: 75 ohm input (BNC), dBmV calibration	add \$100
Opt 910: Extra 8558B Manual	add \$20
182T Large Screen Display	\$2615
180TR Rack Mount Display	\$2760
181T Variable Persistence Display	\$3565
181TR Rack Mount 181T Display	\$3840
8444A Opt 059 Tracking Generator	\$4450
8750A Storage-Normalizer	\$1750

SIGNAL ANALYZERS

Spectrum Analyzer, 0.01 to 21 GHz
Models 8559A/182T & 8750A

- Simplified operation
- Direct display of signal level in dBm

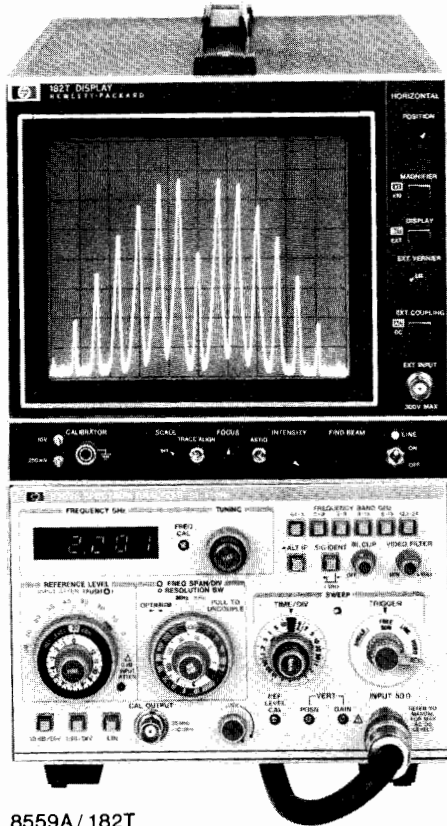

8559A/182T

8559A Spectrum Analyzer

Economy With Precision

The HP 8559A is a 0.01 to 21 GHz spectrum analyzer plug-in for the HP 180 series displays. It features the performance essential for accurate signal analysis yet is easy to use and portable. This combination with its economical price qualifies the 8559A for a wide variety of applications in R&D, production and service.

Simple 3-knob Operation

Most measurements can quickly be made using only 3 controls. Just tune to the signal; the LED readout displays its frequency. Zoom-in on the signal by reducing the span width; the resolution bandwidth, video filter, and sweep time automatically change to the optimum values for a calibrated display. A reference level change brings the peak of the signal to the top of the screen for the most accurate amplitude measurement.

Absolute Amplitude Calibration

Signal levels can be measured accurately and read directly from the CRT in dBm. The signal level represented by the top CRT graticule line is always indicated by the reference level control, and scale factors of 10 dB/div, 1 dB/div, and linear can be selected.

8750A Storage-Normalizer

The 8750A is an accessory which provides digital storage, trace comparison and normalization where data in memory is subtracted from current input and then displayed. In conjunction with the 182T display mainframe and the 8559A, the 8750A provides flicker-free display of measured signals. Additionally, two traces can be viewed from memory for CRT photography or detailed signal comparison.

- Resolution bandwidths of 1 kHz to 3 MHz
- Digital storage-normalizer available

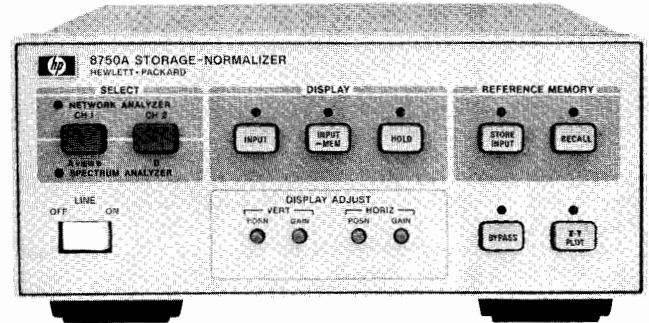

8750A

11870A Low Pass Filter (DC to 2.6 GHz)

For RF applications needing extended coverage to 2.6 GHz, this low pass filter will reject signals above 3 GHz by more than 60 dB for image-free measurements over the entire 10 MHz to 2.6 GHz range.

Recommended Displays

The 8559A Spectrum Analyzer will function with any 180-series display. However, the following are recommended: for low cost, large screen display, the Model 182T is ideal; the Model 181T offers variable persistence and storage; the Model 180TR offers a rack mount configuration; and the Model 181TR offers variable persistence and storage in a rack mount configuration.

8559A Specifications

Frequency Specifications

Frequency range: 0.01 to 21 GHz.

Frequency span modes (on a 10 division CRT horizontal axis): 14 calibrated spans from 200 MHz/div to 10 kHz/div in a 1, 2, 5 sequence. In "F" or full span the analyzer sweeps the entire band selected. In "0" or zero span, the analyzer is a fixed-tuned receiver.

Accuracy: frequency error between any two points on the display is less than $\pm 5\%$ of the indicated frequency separation.

Stability

Residual FM: < 1 kHz p-p in 0.1 s for 100/120 line voltages, < 2 kHz p-p for 220/240 line voltages.

Noise sidebands: > 70 dB below when 30 kHz or more from carrier in a 1 kHz bandwidth with full video filter (not in detent).

Resolution

Bandwidth ranges: 3 dB resolution bandwidths of 1 kHz to 3 MHz in a 1, 3 sequence. Resolution bandwidth may be coupled to frequency span at a ratio of two display spans per resolution bandwidth.

Resolution bandwidth accuracy: individual resolution bandwidth 3 dB points calibrated to $< \pm 15\%$ (except 3 MHz: $< \pm 30\%$).

Resolution bandwidth selectivity: 60 dB/3 dB resolution bandwidth ratio $< 15:1$.

Video filter: post detection filter used to average displayed noise. Bandwidth variable from approximately 3X Resolution Bandwidth to approximately 0.01X Resolution Bandwidth. In the MAX position provides a noise averaging filter with a bandwidth of approximately 1.5 Hz.

Amplitude Specifications

Absolute Amplitude Calibration Range

Log calibration range: from -112 dBm to $+30$ dBm in 10 dB steps. Reference level vernier, 0 to -12 dB continuously.

Log display ranges: 10 dB/div on a 70 dB display, and 1 dB/div on an 8 dB display.

Linear display: from 0.56 microvolts (-112 dBm) full scale to 7.1 volts (+30 dBm) full scale. Full scale signals in linear translate to approximately full scale signals in log.

Dynamic Range

Average noise level: see table below.

Spurious responses: all second harmonic and third order inter-modulation distortion products are greater than 70 dB below a -40 dBm input signal(s) and for 0 dB input attenuation.

Alternate IF: available over entire tuning range. Nominal first IF at 3.0075 GHz becomes 2.9925 GHz, and adds <1.0 dB of error to reference level unless recalibrated.

Signal identifier: provided on all frequency bands and frequency spans for positive signal identification. Available in all spans and usable for spans from 10 MHz to 100 kHz/div.

Residual responses (no signal present at input): <-90 dBm with 0 dB input attenuation.

Amplitude Accuracy

Frequency response (flatness): see table below

Frequency Range (GHz)	Avg. Noise Level (dBm/1 kHz)	Frequency Response (\pm dB max.)	Amplitude Accuracy (\pm dB max.)
0.01-3	-111	1.0	2.3
6.0-9	-108	1.0	2.3
3.0-9	-103	1.5	2.8
9.0-15	-98	1.8	3.1
6.0-15	-93	2.1	3.4
12.1-18	-92	2.3	3.6
18.0-21	-90	3.0	4.3

Switching Between Bandwidths

3 MHz to 300 kHz: \pm 0.5 dB.

3 MHz to 1 kHz: \pm 1.0 dB.

Reference level variation (input attenuator at 0 dB): 10 dB steps, < \pm 1.0 dB (-10 to -100 dBm); vernier (0 to -12 dB) continuous, < \pm 0.5 dB.

Amplitude log display: \pm 0.1 dB/dB, but not more than \pm 1.5 dB over full 70 dB display range.

Calibrator

Amplitude: -10 dBm \pm 0.3 dB.

Frequency: 35 MHz \pm 400 kHz.

Input Specifications

Input connector: type N female.

Input impedance: 50 Ω nominal. Typical reflection coefficient <0.34 (2.0 SWR) for 0 dB input attenuation, <0.13 (1.3 SWR) for 10 dB input attenuation.

Input attenuator: 70 dB range. Accuracy \pm 1 dB per 10 dB step but not more than \pm 2.4 dB over 60 dB range.

Maximum Input Levels

Gain compression: less than 0.5 dB for -10 dBm input level with 0 dB input attenuation.

Total power: +20 dBm (100 mW, \pm 3.16V) with 0 dB input attenuation, +30 dBm (1W, \pm 10V) with \geq 10 dB input attenuation.

Peak pulse power: \pm 50 dBm (100 W, 10 μ sec pulse width, 0.01% duty cycle) with \geq 30 dB input attenuation.

DC (<100 Hz): \pm 7.1V.

Output Characteristics

Cal output: -10 dBm, 35 MHz.

Note: The following oscilloscope display rear panel outputs refer to 180TR, 181T, 181TR, 182T displays and older 180-series displays with Option 807 only.

Vertical output (AUX A on oscilloscope display rear panel): 0 to 0.8 V for 8-division deflection on CRT display; 50 Ω output impedance.

Pen lift-blanking output (AUX B on oscilloscope display rear panel): 0 to 15 V (0 V, pen down). Approximately 10 k Ω impedance when blanked. Compatible with HP 7004B, 7034B, and 7005B, and 7035B X-Y Recorders.

21.4 MHz IF output (AUX C on oscilloscope display rear panel): a 21.4 MHz output linearly related to the RF input to the analyzer.

Bandwidth controlled by analyzer Resolution Bandwidth setting. Amplitude controlled by input attenuator, IF gain vernier, and first six IF step gain positions (-10 through -60 dBm Ref Level with 0 dB input attenuation). Output is approximately -10 dBm for full-scale signals on the CRT, 50 Ω output impedance.

Horizontal output (AUX D on oscilloscope display rear panel): -5.0 to +5.0 V for 10 div CRT deflection, 5 k Ω output impedance.

Sweep Characteristics

Sweep Time

Auto: sweep time is automatically controlled by Frequency Span, Resolution Bandwidth, and Video Filter.

Manual: sweep determined by front panel control, continuously variable across CRT in either direction.

Calibrated sweep time: 20 internal sweep times from 2 μ sec to 10 sec/div in a 1,2,5 sequence (except 2 sec/div). For sweep times of 2 ms/div to 10 sec/div, the analyzer is operable in its normal swept frequency mode. Faster sweeps are useful for analyzing modulation waveforms when the analyzer is being operated as a fixed-tuned receiver with zero span. Sweep times may be reduced to an effective 0.2 μ sec/div by using the 180 series X10 horizontal magnifier.

Accuracy: \pm 10%.

Sweep Trigger

Video: sweep internally triggered by envelope of RF input signal (signal amplitude of 1.0 division peak-to-peak required on CRT display).

Line: sweep triggered by power line frequency.

Free run: sweep triggered repetitively by internally generated ramp.

Single: sweep triggered by front panel sweep trigger switch (spring return position).

General Characteristics

180 series compatibility: the 8559A is compatible with all 180A, 180AR, 180C, 180D, 180F, 181A, 181AR, 182A, 184A, and 184B mainframes. It is operable with the 183A, 183B mainframes, but the display is limited to 6 divisions by the 6-division CRT. The 180T series oscilloscope displays are recommended for use with the 8559A Spectrum Analyzer because they provide 4 non-buffered rear panel auxiliary outputs (for unattenuated vertical, horizontal, and pen-lift outputs) and P39 medium-persistence CRT phosphor (except with 181T, 181TR which have P31 phosphor and provide variable persistence).

EMI: conducted and radiated interference is within requirements of methods CE03 and RE02 of MIL STD 461A, VDE 0871 Level B, CISPR Publication 11 (1975), and Postverfuegung 527/1979.

Power: (including oscilloscope display) 115 or 230 volts \pm 10%, 48 to 440 Hz, less than 200 VA.

Weight

Model 8559A: net, 5.5 kg (12.5 lb). Shipping 9.1 kg (20 lb).

Model 182T: net, 12.3 kg (27 lb). Shipping 15.5 kg (34 lb).

Model 181T: net, 10.9 kg (24 lb). Shipping 15.5 kg (34 lb).

Model 180TR or 181TR: net, 11.8 kg (26 lb). Shipping 17.2 kg (38 lb).

Size

Model 182T: (cabinet/large screen): 338.1 H x 201.6 W x 498.5 mmD (13.3" x 7.9" x 19.6").

Model 181T: (cabinet/variable persistence): 289 H x 200 W x 530 mmD (11.4" x 7.9" x 21.3").

Model 180TR or 181TR (rack/standard and variable persistence): 133 H x 425 W x 543 mmD (5.2" x 16.8" x 21.4")

Ordering Information

8559A Spectrum Analyzer

Opt 910: Extra 8559A Manual

182T Large Screen Display

180TR Rack Mount Display

181T Variable Persistence Display

181TR Rack Mount 181T Display

8750A Storage-Normalizer

11870A Low Pass Filter

Price

\$10,500

add \$20

\$2,615

\$2,760

\$3,565

\$3,840

\$1,750

\$300

SIGNAL ANALYZERS

Plug-In Spectrum Analyzer System, 20 Hz to 40 GHz
Model 141T system

- 20 Hz to 40 GHz with just a tuning section change
- Advantages of fully calibrated solid state system
- Add measurement capability to your system as needed

- Tracking generator expands measurement capability
- Increase dynamic range with tracking preselector
- Storage-normalizer adds digital storage

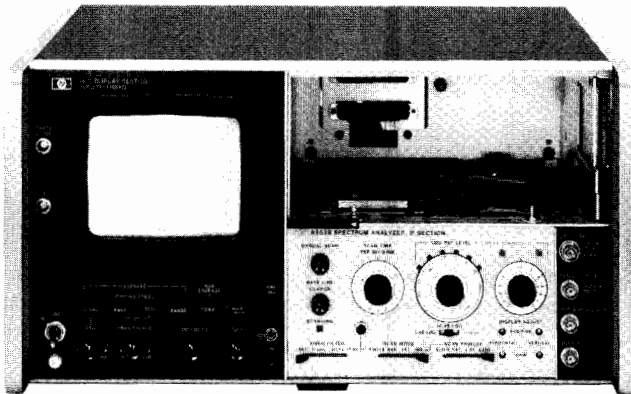

141T, 8552B

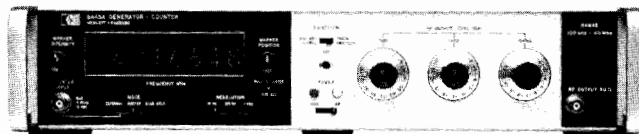

8443A

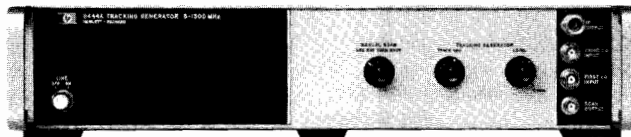

8444A

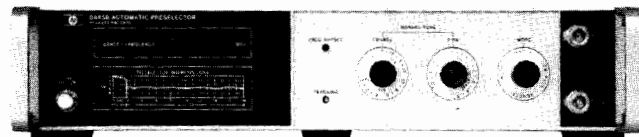

8445B Opt 002, 003

Hewlett-Packard's high performance plug-in spectrum analyzer family makes frequency domain measurements from 20 Hz to 40 GHz. Because of the system's modularity, the user need purchase only analyzer components necessary to meet immediate production or laboratory measurement requirements. Then, as broader frequency capability is required, additional tuning sections or companion instruments can be added.

The models 8553B, 8554B, 8555A, and 8556A are tuning sections which plug into a 141T display mainframe along with an 8552B IF section to form a member of the Hewlett-Packard high performance spectrum analyzer family. Each tuning section covers a frequency range convenient for equipment design or spectrum surveillance: 8556A, 20 Hz to 300 kHz; 8553B, 1 kHz to 110 MHz; 8554B, 100 kHz to 1250 MHz; and 8555A, 10 MHz to 40 GHz. The IF section plug-in which is used with each tuning section, serves to condition the measurement signal for proper display on the CRT. Two IF sections are available, the 8552B high performance model and the 8552A model for economy. The spectrum analyzer specifications included in this catalog assume the use of the 8552B.

The 8443A and 8444A are tracking generators complementing the basic spectrum analyzer function with an RF source locked to the tuning frequency. The 8445B is an automatic preselector which enhances the dynamic range of the 10 MHz to 40 GHz 8555A tuning section analyzer.

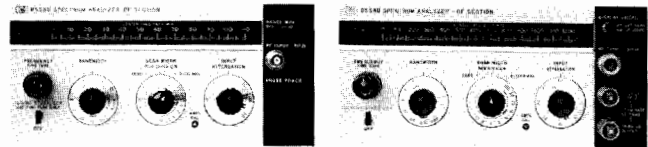

8553B

8554B

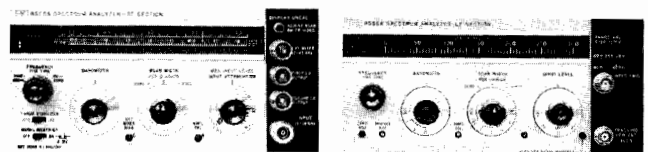

8555A

8556A

The 141T based spectrum analyzer features absolute calibration of frequency and amplitude, high resolution and sensitivity, wide dynamic range, and simple to interpret display output.

The following pages cover spectrum analyzer performance with each of the tuning sections and companion tracking generator/preselector.

Absolute Amplitude Calibration

For ease and speed of measurement, full frequency band amplitude calibration allows direct interpretation of signal power or voltage from the CRT display. A choice of logarithmic or linear scaling calibrates the CRT in dBm or μV respectively. Front panel settings set the top horizontal graticule on the CRT as the reference power in the logarithmic mode; all other CRT measurements can be made relative to this reference. In linear scaling the CRT is calibrated in voltage per division using front panel settings. The bottom graticule is zero voltage.

When a combination of frequency scan, bandwidth, or video filter settings are chosen such that the display becomes uncalibrated, a warning light indicates the condition.

High Resolution Frequency Calibration

The frequency measurement capability of the spectrum analyzer is responsive to user need, making spectrum measurements simply and accurately with three frequency scan modes.

First is the FULL scan mode, which displays the entire tuning section frequency band on the 10 cm horizontal CRT graticule. This mode is effective in viewing broadband effects of circuit adjustments and refinements as they are made. In FULL scan a marker on the CRT corresponds in frequency to the position of the pointer on the tuning section frequency scale, so signals can be readily identified.

The second mode, PER DIVISION scan, centers the display about the frequency indicated by the tuning section pointer. In this mode, narrow, calibrated scan per division and automatic frequency stabilization make high resolution measurements for analysis of signal purity, sidebands, and low deviation FM.

In the third mode, ZERO scan, the analyzer becomes a receiver tuned to the frequency indicated on the scale. Modulation in an input signal at the tuned frequency is displayed on the CRT in the time domain. The scan time control provides a calibrated time base.

High Resolution

The ability to resolve close-in signal sidebands, such as line related modulation, is important in frequency domain analysis. The Hewlett-Packard 141T plug-in spectrum analyzers each have narrow bandwidths for such resolution. Up to 110 MHz, the analyzers offer 10 Hz bandwidths and 100 Hz bandwidths to 18 GHz. The frequency stabilization feature already mentioned ensures high resolution by maintaining a jitter-free display.



Wide Dynamic Range, Sensitive

Confidence in signal identification is given by the analyzer's ability to measure wide amplitude differentials without distortion products and to measure very low-level signals. The plug-in spectrum analyzers have typically 70 dB of distortion free dynamic range; that is, the capability of measuring 0.03% signal distortion from the CRT display. With the 8445B Preselector the 8555A has a spurious-free range of 100 dB. The CRT displays full dynamic range on a linear, easy to read scale.

Signals at as low a level as -142 dBm (18 nanovolts, 50 ohms) can be detected by the spectrum analyzer with 10 Hz bandwidth. At high frequencies and with 100 Hz bandwidth, -125 dBm signals can be measured.

A Parallax-free, Storable Display

The 141T spectrum analyzer mainframe and display features a variable persistence CRT which enables response storage for any measurement. With very narrow bandwidth measurements, extremely slow sweeps are necessary to maintain amplitude calibration (allowing band-pass filters time to respond). A recording CRT is necessary to save this response for viewing. Of course, any response can be stored for a display ready to be photographed. Another display mainframe, the 140T, is available with standard persistence.

Interpretation of response levels on the CRT is free from parallax since the graticule is etched on the inside of the display screen adjacent to the phosphor.

IF Section Adds Convenience Features

The high resolution 8552B or the economic 8552A IF section features video filtering, recorder outputs and an internal calibration signal to make the spectrum analyzer easier to use. Video filtering is a low-pass filter which averages noise amplitude response for easier small signal readings. It also makes wide band noise measurements easier.

Recorder outputs, including pen lift, allow hard copy duplication of the CRT display. Manual scan allows setting up of accessories, such as X-Y recorders, adjusting signals on screen during slow scans and measuring frequencies with a counter.

The internal calibration standard is a very stable -30 dBm, 30 MHz signal for quick front panel calibration.

Tracking Generators for Each Frequency Band

Either available internally, or as a companion instrument, are leveled signal sources designed to track the swept tuning frequency of the spectrum analyzer. Amplifiers, filters or any circuit which requires an input signal can be characterized to 1300 MHz, with typically wider dynamic range and more precise frequency accuracy than with the spectrum analyzer alone.

The 8556A low frequency tuning section has an internal tracking generator, standard with the instrument. The 8553B and 8554B/8555A use separate generators namely 8443A and 8444A respectively.

8750A Storage-Normalizer

You can add digital storage to the 140-series spectrum analyzer with the 8750A (Opt. 001) and an external oscilloscope. Digital storage provides a flicker-free display regardless of the analyzer sweep speed and facilitates trace comparisons of two traces. If a tracking generator is employed, the normalization feature significantly reduces frequency response variations. The 8750A Storage-Normalizer is a versatile accessory which may be used directly with other HP spectrum and network analyzers. (See page 501).

General Specifications

141T Spectrum Analyzer System

Input impedance: 50 Ω nominal. Reflection coefficient <0.30 (1.85 SWR), input attenuator ≥ 10 dB.

Maximum input level: peak or average power $+13$ dBm (1.4 V ac peak), ± 50 V dc.

Attenuator: 0 to 50 dB in 10 dB steps.

Scan time: 16 internal scan rates from 0.1 ms/div to 10 sec/div in a 1, 2, 5 sequence, and manual scan (8552B only).

Scan Time Accuracy

0.1 ms/div to 20 ms/div: $\pm 10\%$.

50 ms/div to 10 s/div: $\pm 20\%$.

Scan Mode

Int: analyzer repetitively scanned by internally generated ramp; synchronization selected by scan trigger

Single: single scan with front panel reset.

Ext: scan determined by 0 to $+8$ volt external signal.

Manual: scan determined by front panel control.

Scan trigger: for internal scan mode, select between

Auto: scan free-runs.

Line: scan synchronized with power line frequency.

Ext: scan synchronized with >2 volt (20 volt max.) signal.

Video: scan internally synchronized to envelope of RF input.

Auxiliary outputs:

Vertical output: 0 to -0.8 V for full deflection.

Scan output: -5 V to $+5$ V for 10 div CRT deflection.

Pen lift output: 0 to 14 V (0 V, pen down).

Display Characteristics

141T, 140T

Plug-ins: accepts Models 8552A/B, 8553B, 8554B, 8555A and 8556A and Model 140 series Oscilloscope plug-ins.

Cathode-Ray Tube Type

Model 141T: post-accelerator storage tube, 9000 volt accelerating potential; aluminized P31 phosphor.

Model 140T: post-accelerator, 7300 volt potential medium-short persistence (P39) phosphor.

Cathode-Ray Tube Graticule

Model 141T: 8 x 10 division (approx, 7.1 cm x 8.9 cm parallax-free internal graticule).

Persistence, Model 141T Only

Normal: natural persistence of P31 phosphor (0.1 second).

Variable

Normal writing rate mode: continuously variable from less than 0.2 second to more than one minute.

Maximum writing rate mode: from 0.2 second to 15 seconds.

Erase: manual; erasure takes approximately 350 ms.

Storage time model 141T only: normal writing rate; more than 2 hours at reduced brightness (typically 4 hours).

Fast writing speed, model 141T only: more than 15 minutes.

Functions used with oscilloscope plug-ins only. Intensity modulation, calibrator; beam finder.

EMI: conducted and radiated interference is within requirements of MIL-1-16910C and MIL-1-6181D and methods CEO3, and REO2 of MIL-STD-461 (except 35 to 40 kHz) when appropriate RF tuning section and 8552A or 8552B are combined in a 140T or 141T Display Section.

Temperature range: operating, 0°C to $+55^{\circ}\text{C}$; storage, -40°C to $+75^{\circ}\text{C}$.

Power requirements: 100, 120, 220, or 240V $+5\%$, -10% . 50 to 60 Hz, normally less than 225 watts (includes plug-ins used).

Weight

Model 8552A or 8552B IF section: net, 4.1 kg (9 lb). Shipping 6.4 kg (14 lb).

Model 140T display section: net, 18 kg (40 lb). Shipping, 25 kg (54 lb).

Model 141T display section: net, 19.2 kg (43 lb). Shipping, 26 kg (57 lb).

Tuning section: see following pages.

Size: model 140T or 141T with plug-ins: 221 H x 425 W x 416 mm D (8.8" x 16.8" x 16.4").

Special order: chassis slides and adapter kit.

Ordering Information

140T Normal Persistence Display

Opt 90B: Rack Flange Kit

141T Variable Persistence Display

Opt 90B: Rack Flange Kit

8552A Economy IF Section

8552B High Resolution IF Section

Price

\$2700

add \$27

\$3510

add \$27

\$3950

\$5300

SIGNAL ANALYZERS

141T Spectrum Analyzer System: 20 Hz to 300 kHz

Model 8556A

- Accurate signal level measurements (± 0.95 dB)
- Accurate frequency measurements (± 3 Hz)
- High sensitivity (-152 dBV)
- Built-in tracking generator

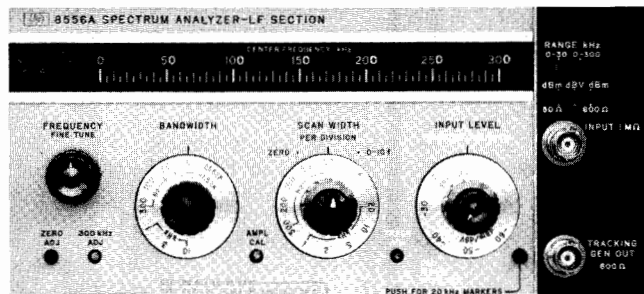

8556A

General Purpose Measurement Flexibility

The 8556A Spectrum Analyzer covers the frequency range from 20 Hz to 300 kHz. It was designed to accommodate the variety of characteristic impedances and amplitude units used in making audio measurements. Balanced or unbalanced inputs are available, and open circuit voltages (dBV or linear) or power (dBm) in several characteristic impedances may be measured. The analyzer is capable of high resolution; frequencies can be measured very accurately. A built-in tracking generator further increases the instrument's utility.

Frequency Range

The 8556A has two frequency scales, 0–300 kHz for full coverage and 0–30 kHz for better resolution at low frequencies. The analyzer may be swept symmetrically about a tunable center frequency, swept from 0 Hz to a selectable end point, or operated as a fixed tuned receiver. 20 kHz crystal markers (accurate to 0.01%) can be generated on the CRT to make very accurate frequency measurements.

Absolute Amplitude Calibration

The 8556A is calibrated for dBm in 600 Ω , dBm in 50 Ω , dBV, and volts. The very accurate reference level control (± 0.2 dB) and vernier (± 0.25 dB) allow the IF substitution technique to be used to improve amplitude measurement accuracy.

Low Distortion

Careful design has decreased analyzer distortion to the extent that a full 70 dB dynamic range is achieved. This allows small signals, such as harmonic or intermodulation distortion, to be measured in the presence of large ones.

Resolution—Sensitivity

Resolution bandwidths from 10 Hz to 10 kHz are provided on the 8556A. Using the narrow bandwidth, 50 or 60 Hz line related sidebands can be measured. The analyzer's extremely low noise figure together with its narrow bandwidths makes the 8556A very sensitive. Signals as low as -152 dBV (25 nV) can be measured in a 10 Hz bandwidth. The 8556A may be used to measure EMI, such as interference conducted along an ac power line.

Isolated Input

The isolated input eliminates the possibility of spurious signal pickup which could be caused by line related ground currents flowing in the ground connections between the analyzer and signal source. The input impedance (1 M Ω) is high enough so that a scope probe may be used with a minimum of loading. An optional balanced input is available which is transformer coupled for isolation and high common mode rejection. The input impedance is 15 k Ω , and the analyzer is calibrated for either dBm-135 Ω or dBm-150 Ω as well as dBm-600 Ω and dBm-900 Ω . Balance (symmetry) is 80 dB at 50 Hz and typically 50 dB at 300 kHz.

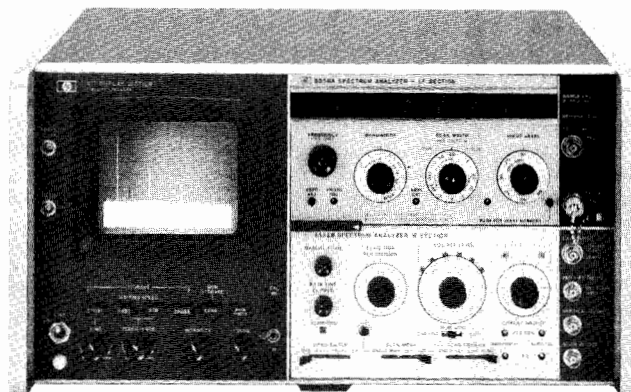

Tracking Generator

A tracking generator is built into the 8556A. If an external counter is connected to the tracking generator, frequencies can be measured to an accuracy of ± 3 Hz. Swept insertion loss or return loss measurements can be made on a device such as an amplifier or filter. A 140 dB measurement range is possible using the narrowest resolution bandwidth. The tracking generator also provides a convenient signal for compensating an oscilloscope probe used with the 8556A.

Other Applications

The combination of a tracking generator and spectrum analyzer in this frequency range is valuable in applications such as receiver testing and fault location.

Specifications—with 8552B IF Section

Frequency Specifications

Frequency range: 20 Hz to 300 kHz. Tuning dial ranges of 0–30 kHz and 0–300 kHz.

Scan width: (on a 10-division CRT horizontal axis)

Per division: 10 calibrated scan widths from 20 Hz/div to 20 kHz/div in a 1, 2, 5 sequence.

0–10 f: 10 calibrated preset scans, from 200 Hz to 200 kHz in a 1, 2, 5 sequence. Analyzer scans from zero frequency to ten times the scan width per division setting.

Zero: analyzer is a fixed tuned receiver.

Frequency Accuracy

Center frequency accuracy: 0–30 kHz Range: ± 500 Hz; 0–300 kHz Range: ± 3 kHz.

Marker accuracy: RF markers every 20 kHz accurate to within $\pm 0.01\%$. Markers controlled by front panel on/off switch.

Scan width accuracy: frequency error between any two points on the display is less than $\pm 3\%$ of the indicated frequency separation.

Stability

Residual FM: sidebands >60 dB down 50 Hz or more from CW signal, scan time ≥ 1 sec/div, 10 Hz bandwidth.

Noise sidebands: more than 90 dB below CW signal, 3 kHz away from signal, with a 100 Hz IF bandwidth.

Frequency drift: less than 200 Hz/10 min.

Resolution

Bandwidth ranges: IF bandwidths of 10 Hz to 10 kHz are provided in a 1, 3, 10 sequence.

Bandwidth accuracy: individual IF bandwidth 3 dB points calibrated to $\pm 20\%$ (10 kHz bandwidth $\pm 5\%$).

Bandwidth selectivity: 60 dB/3 dB IF bandwidth ratios, with IF section: $<11:1$ for IF bandwidths from 10 Hz to 3 kHz; $<20:1$ for 10 kHz bandwidth. For 10 Hz bandwidth, 60 dB points are separated by less than 100 Hz.

Amplitude Specifications

Absolute Amplitude Calibration

Log calibration modes

dBV	0 dBV = 1 V rms
dBm-600Ω	0 dBm = 1 mW-600Ω
dBm-50Ω	0 dBm = 1 mW-50Ω

Input impedance is 1 MΩ. dBm ranges are referenced with input properly terminated externally.

Log calibration range: from -150 dBm/dBV to +10 dBm/dBV.

Log display range: 10 dB/div on a 70 dB display, or 2 dB/div on a 16 dB display.

Linear sensitivity: from 0.1 μV/div to 1 V/div in a 1, 2, 10 sequence. Linear sensitivity vernier X1 to X0.25 continuously.

Dynamic Range

INPUT LEVEL control: -10 to -60 dBm/dBV in 10 dB steps. Accuracy ±0.2dB. Marking indicates maximum input levels for 70 dB spurious-free dynamic range.

Average noise level: (specified with a 600Ω or less source impedance and INPUT LEVEL at -60 dBm/dBV)

Mode	1 kHz IF Bandwidth	10 Hz IF Bandwidth
dBm-50Ω	<-122 dBm (180 nV)	<-142 dBm (18 nV)
dBm-600Ω	<-130 dBm (250 nV)	<-150 dBm (25 nV)
dBV	<-132 dBV (250 nV)	<-152 dBV (25 nV)
Linear	<400 nV	<40 nV

Video filter: averages displayed noise; bandwidth of 10 kHz, 100 Hz, and 10 Hz. Bandwidth accuracy ±20%.

Spurious responses: input signal level ≤ INPUT LEVEL setting; out of band mixing responses, harmonic and intermodulation distortion products are all more than 70 dB below the input signal level 5 kHz to 300 kHz; 60 dB, 20 Hz to 5 kHz. Third order intermodulation products are more than 70 dB below the input signal level, 5 kHz to 300 kHz with signal separation >300 Hz.

Residual responses (no signal present at input): With the INPUT LEVEL at -60 dBm/dBV and the input terminated with 600Ω or less, all line related residual responses from 0 to 500 Hz are below -120 dBm/dBV. All other residual responses are below -130 dBm/dBV.

Amplitude accuracy:	Log	Linear
Frequency response	±0.2 dB	±2.3%
Amplitude display	±0.25 dB/dB but not more than ±1.5 dB over 70 dB display range	±2.8% of full 8 div display

Log reference level control: provides 90 dB IF gain control in 10 dB steps. Accurate to ±0.2 dB (±2.3%).

Log reference level vernier: provides continuous 12dB range. Accurate to ±0.1 dB (±1.2%) in 0, -6, -12 dB positions; otherwise ±0.25 dB (±2.8%).

Amplitude measurement accuracy: ±0.95 dB with proper technique.

General

Scan time: 16 internal scan rates from 0.1 ms/div to 10 sec/div in a 1, 2, 5 sequence.

Scan Mode

Int: analyzer repetitively scanned internally.

Ext: scan determined by 0 to +8 volt external signal.

Single: single scan actuated by front panel button.

Manual: scan determined by front panel control.

Input level: provides 50 dB control of input preamplification and attenuation to prevent input overload. INPUT LEVEL markings of -60 dBm/dBV to -10 dBm/dBV indicate maximum input level for a minimum of 70 dB spurious-free dynamic range. Accuracy ±0.2 dB (2.3%).

Input impedance: 1 MΩ shunted by ≈32 pF.

Maximum input level: 10 V rms, ±200 V dc. Ground terminals of BNC input connectors are isolated from the analyzer chassis ground to minimize ground loop pickup at low frequencies.

Maximum voltage, isolated ground to chassis ground: ±100 V dc.

Isolated ground to chassis ground impedance: 100 kΩ shunted by approximately 0.3 μF.

Gain compression: for input signal level 20 dB above INPUT LEVEL setting, gain compression is less than 1 dB.

Tracking Generator Specifications

Frequency range: tracks the analyzer tuning, 20 Hz to 300 kHz.

Amplitude range: continuously variable from 100 mV rms to greater than 3 V rms into an open circuit.

Amplitude accuracy: with TRACKING GEN LEVEL in CAL position and 20 kHz markers off, output level at 100 kHz is 100 mV ±0.3 dB into an open circuit.

Frequency response: ±0.25 dB 50 Hz to 300 kHz.

Output impedance: 600Ω.

Residual FM: <1 Hz peak-to-peak.

Power requirements: 100, 120, 200, or 240 V +5%, -10%, 50 to 60 Hz, normally less than 225 watts.

Weight: Model 8556A LF section: net, 3.7 kg (8 lb). Shipping, 5.3 kg (12 lb).

Size: 102 x H x 226 x W 344 mm D (4" x 8.9" x 13.5").

Specifications with 8556A Options 001, 002-balanced Input

Amplitude

Log calibration modes-balanced (bridged) input

dBm-135Ω (Option 001)	0 dBm = 1mW-135Ω
dBm-150Ω (Option 002)	0 dBm = 1mW-150Ω
dBm-600Ω	0 dBm = 1mW-600Ω
dBm-900Ω	0 dBm = 1mW-900Ω

Input impedance is typically 15 kΩ. dBm ranges are referenced with input properly terminated externally.

Input

Maximum input levels: Normal Mode, ±20 V rms or ±150 V dc for normal mode (symmetrical) signals between input signal connectors; Common Mode, 200 V rms at 60 Hz or ±500 V dc for common mode (asymmetrical) voltages between input signal connectors and GUARD or instrument chassis; GUARD, ±100 V dc from GUARD to instrument chassis. (GUARD to chassis impedance is approximately 100 kΩ shunted by 0.3 μF.)

Balance (symmetry): 0 -30kHz Range, greater than 80 dB, 50 Hz to 1 kHz; 1 -300 kHz range, greater than 60 dB, 1 kHz to 20 kHz.

Ordering Information

8556A RF Section
Opt 001: Balanced input
Opt 002: Balanced input

Price
 \$3375
 add \$220
 add \$220

SIGNAL ANALYZERS

141T Spectrum Analyzer System: 1 kHz to 110 MHz

Models 8553B & 8443A

- Wide frequency range
- 10 Hz resolution bandwidth
- High sensitivity (-140 dBm)

- Accurate amplitude measurements (± 1.25 dB)
- 10 Hz frequency accuracy with tracking generator
- 130 dB swept measurement range

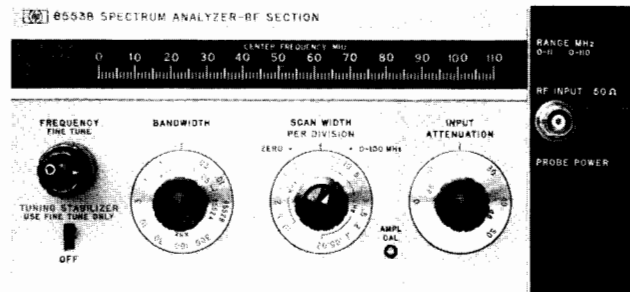

8553B

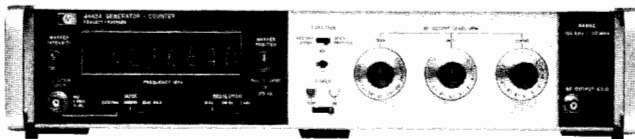

8443A

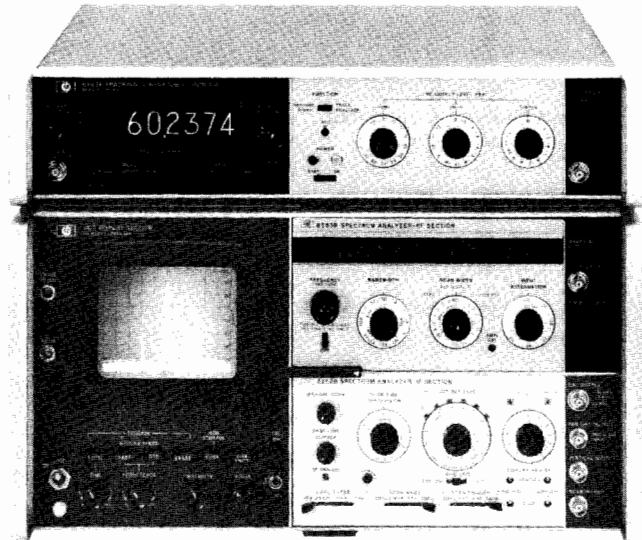

General Purpose

The 8553B Spectrum Analyzer makes absolute amplitude and frequency measurements over the 1 kHz to 110 MHz range. This frequency span includes audio, video, navigation aids, telemetry, multiplex communication systems basebands, commercial AM, FM, TV, and land mobile communication. The analyzer features high resolution and stability, low distortion, high sensitivity, and a wide dynamic range. A tracking generator is available which improves the frequency measurement accuracy of the analyzer and can be used to make swept measurements.

Wide Frequency Range

The broad frequency range of 1 kHz to 110 MHz extends from audio through the FM broadcast band. Scan widths from 200 Hz to 100 MHz allow a user to view all or selected parts of the frequency spectrum while the zero scan mode turns the analyzer into a fixed tuned receiver and displays amplitude variations in the time domain. The analyzer has two dial scales, 0-110 MHz for full coverage and 0-11 MHz for better resolution at low frequencies.

Resolution—Stability

The 8553B has resolution bandwidths that range from 300 kHz to 10 Hz. Wide bandwidths are necessary for making measurements on a wideband spectrum such as FM. The extremely high resolution 10 Hz bandwidth allows measurement of 50 Hz sidebands 60 dB down. Such high resolution is made possible by automatic stabilization through phase lock, which reduces residual FM to a negligible level. Good stability is required to measure oscillator residual FM and drift.

Absolute Amplitude Calibration

The 8553B Spectrum Analyzer is absolutely calibrated in both dBm and volts from -142 dBm (18 nV) to $+10$ dBm (0.7 V). This absolute calibration is derived from a built-in calibrator (-30 dBm at 30 MHz) and extremely flat analyzer frequency response (± 0.5 dB). A display uncal. light warns if the display becomes uncalibrated. The probe power output supplies power to a high impedance probe which can be used to make bridging measurements on circuits terminated at both ends.

High Sensitivity

A low analyzer noise figure and narrow bandwidths give the 8553B very high sensitivity. Signal levels as low as -140 dBm can be measured in 10 Hz bandwidth, and a preamplifier is available to further increase sensitivity by 16 dB. Video filtering in 10 kHz, 100 Hz and 10 Hz bandwidths will average the displayed noise. High analyzer sensitivity is required if distortion in an amplifier or oscillator is to be measured as a function of output level. In EMI studies, field strength can be measured with a calibrated antenna.

70 dB Dynamic Range

The 8553B has a 70 dB dynamic range when the signal level is properly conditioned at the input mixer. A wide dynamic range is necessary to measure small signals in the presence of large ones, such as harmonic or intermodulation distortion or to monitor signals of widely varying amplitudes, such as in EMC, RFI, and surveillance work.

8443A Tracking Generator-Counter

A tracking generator, 8443A, is available which covers the 100 kHz to 110 MHz frequency range of the 8553B. It has a built-in counter, and precision RF attenuators which are useful in making substitution measurements.

Frequency Accuracy

In conjunction with an 8443A Tracking Generator, the 8553B Spectrum Analyzer can measure frequencies to an accuracy of ± 10 Hz. When the 8443A is operated in the "track analyzer" mode, the counter will read the frequency at a tunable marker which is generated on the analyzer CRT. The "restore signal" mode is a more convenient way to measure signal frequencies in wide scans because the counter reads the signal frequency automatically without fine tuning. The 8443A Tracking Generator may also be used externally as a 120 MHz direct reading counter.

Swept Measurements

The 8443A Tracking Generator can be used with the 8553B to make swept insertion loss and return loss measurements over the 100 kHz to 110 MHz frequency range. Because the signal source tracks the analyzer's tuning, up to 130 dB dynamic measurement range is possible (at 10 Hz bandwidth). Excellent system flatness (± 1.0 dB) insures the accurate determination of swept response characteristics.



Specifications—with 8552B IF Section

Frequency Specifications

Frequency range: 1 kHz–110 MHz (0–11 MHz and 0–110 MHz tuning ranges).

Scan width (on 10-division CRT horizontal axis)

Per division: 18 calibrated scan widths from 20 Hz/div to 10 MHz/div in a 1, 2, 5 sequence.

Preset: 0–100 MHz, automatically selects 300 kHz bandwidth IF Filter.

Zero: analyzer is fixed tuned receiver with selectable bandwidth.

Frequency Accuracy

Center frequency accuracy: the dial indicates the display center frequency within ± 1 MHz on the 0–110 MHz tuning range; ± 200 kHz on the 0–11 MHz tuning range with FINE TUNE centered, and temperature range of 20°C to 30°C.

Scan width accuracy: scan widths 10 MHz/div to 2 MHz/div and 20 kHz/div to 20 Hz/div: Frequency error between two points on the display is less than $\pm 3\%$ of the indicated frequency separation between the two points. Scan widths 1 MHz/div to 50 kHz/div: Frequency error between two points on the display is less than $\pm 10\%$ of the indicated frequency separation.

Resolution

Bandwidth: IF Bandwidths of 10 Hz to 300 kHz are provided in a 1, 3, 10 sequence.

Bandwidth accuracy: individual IF bandwidths' 3 dB points calibrated $\pm 20\%$ (10 kHz bandwidth $\pm 5\%$).

Bandwidth selectivity: 60 dB/3 dB IF bandwidth ratios: 10 Hz to 3 kHz bandwidths, $< 11:1$, 10 kHz to 300 kHz bandwidths, $< 20:1$; 60 dB points on 10 Hz bandwidth separated by < 100 Hz.

Stability

Residual FM stabilized: sidebands > 60 dB down 50 Hz or more from CW signal, scan time ≥ 1 sec/div, 10 Hz bandwidth (typically less than 1 Hz peak-to-peak).

Residual FM unstabilized: < 1 kHz peak-to-peak.

Noise sidebands: more than 70 dB below CW signal, 50 kHz or more away from signal, with 1 kHz IF bandwidth.

Long term drift (after 1-hour warm-up), stabilized: 500 Hz/10 min; unstabilized: 5 kHz/min, 20 kHz/10 min.

Amplitude Specifications

Absolute Amplitude Calibration Range

Log: from -130 to $+10$ dBm, 10 dB/div on a 70 dB display or 2 dB/div on a 16 dB display.

Linear: from $0.1 \mu\text{V}/\text{div}$ to $100 \text{ mV}/\text{div}$ in a 1, 2 sequence on an 8-division display.

Dynamic Range

Average noise level: < -110 dBm with 10 kHz IF bandwidth.

Video filter: averages displayed noise; 10 kHz, 100 Hz, and 10 Hz bandwidths.

Spurious responses: are below a -40 dBm signal at the input mixer as follows: All image and out-of-band mixing responses, harmonic and intermodulation distortion more than 70 dB down, 2 MHz to 110 MHz; more than 60 dB down, 1 kHz to 2 MHz. Third order intermodulation products more than 70 dB down, 1 kHz to 110 MHz (Signal separation > 300 Hz).

Residual responses (no signal present at input): with input attenuation at 0 dB: < -110 dBm (200 kHz to 110 MHz); < -95 dBm (20 kHz to 200 kHz).

Amplitude accuracy:

Frequency response
(Flatness: attenuator
settings > 10 dB):

1 kHz to 110 MHz
Amplitude Display

	Log	Linear
	± 0.5 dB	$\pm 5.8\%$
	± 0.25 dB/dB	$\pm 2.8\%$ of
	but not more than ± 1.5 dB over the full	full 8 div
	70 dB display range	deflection

Calibrator amplitude: -30 dBm, ± 0.3 dB

Calibrator frequency: 30 MHz, ± 3 kHz.

Log reference level control: provides 70 dB range (60 dB below 200 kHz), in 10 dB steps. Accurate to ± 0.2 dB ($\pm 2.3\%$, Linear Sensitivity).

Log reference level vernier: provides continuous 12 dB range. Accurate to ± 0.1 dB ($\pm 1.2\%$) in 0, -6 , and -12 dB positions; otherwise ± 0.25 dB ($\pm 2.8\%$).

Amplitude measurement accuracy: ± 1.25 dB with proper technique.

General

Input impedance: 50 Ω nominal, BNC connector. Reflection coefficient < 0.13 (1.3 SWR), input attenuator ≥ 10 dB. A special 75 Ω 8553B/8552B is available.

Maximum input level: peak or average power $+13$ dBm (1.4 V ac peak), ± 50 V dc, 1 dB compression point, -10 dBm.

Scan time: 16 internal scan rates from 0.1 ms/div to 10 sec/div in a 1, 2, 5 sequence, or manual scan.

Scan Mode

Int: analyzer repetitively scanned internally.

Ext: scan determined by 0 to $+8$ -volt external signal.

Manual: scan determined by front panel control.

Attenuator: 0 to 50 dB, in 10 dB increments, coupled to Log Reference Level indicator; automatically maintains absolute calibration. Attenuator accuracy ± 0.2 dB.

Power requirements: 100, 120, 220, or 240 V $+5\%$, -10% , 50 to 60 Hz, normally less than 225 watts.

Weight: Model 8553B RF Section: net, 5.5 kg (12 lb). Shipping, 7.8 kg (17 lb).

Size: 102 H x 226 W x 334 mm D (4" x 8.9" x 13.5").

Tracking Generator-Counter (8443A)

Frequency range: 100 kHz to 110 MHz.

Amplitude range: < -120 dBm to $+10$ dBm in 10 and 1 dB steps with a continuous 1.2 dB vernier.

Amplitude Accuracy

Frequency response (flatness): ± 0.5 dB.

Absolute: 0 dBm at 30 MHz: ± 0.3 dB.

Output impedance: 50 Ω , BNC connector, ac coupled, reflection coefficient ≤ 0.09 (1.2 SWR) with output < 0 dBm.

Counter

Display: 7 digits with 1 digit over-range. Reads to ± 10 Hz increments.

Resolution (gate time): 1 kHz (1 ms), 100 Hz (10 ms), 10 Hz (100 ms).

Accuracy: ± 1 count \pm time base accuracy.

Time base aging rate: $< 3 \times 10^{-9}$ /day (0.3 Hz/day) after warm-up.

External counter inputs: 10 kHz to 120 MHz, 50 Ω , -10 dBm min.

Power: 100, 120, 220, or 240 V $+5\%$, -10% , 48 to 440 Hz 75 watts.

Weight: Model 8443A: net, 11.04 kg (24.3 lb). Shipping, 14.47 kg (31.9 lb).

Size: 88.2 H x 425 W x 467 mm D (3.5" x 16.8" x 18.4").

Ordering Information

8553B RF Section

8443A Tracking Generator-Counter

Price

\$3650

\$6300

SIGNAL ANALYZERS

141T Spectrum Analyzer System: 100 kHz to 1250 MHz

Models 8554B & 8444A

- High resolution to 100 Hz
- Flat frequency response ± 1 dB
- High sensitivity to -122 dBm (180 nV)

- Variable persistence display
- Companion tracking generator
- Optional internal limiter

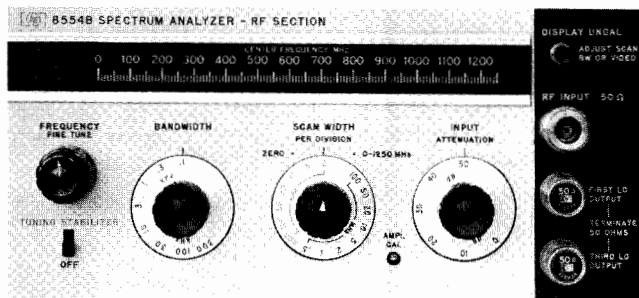

8554B

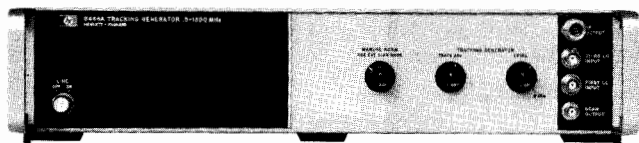

8444A

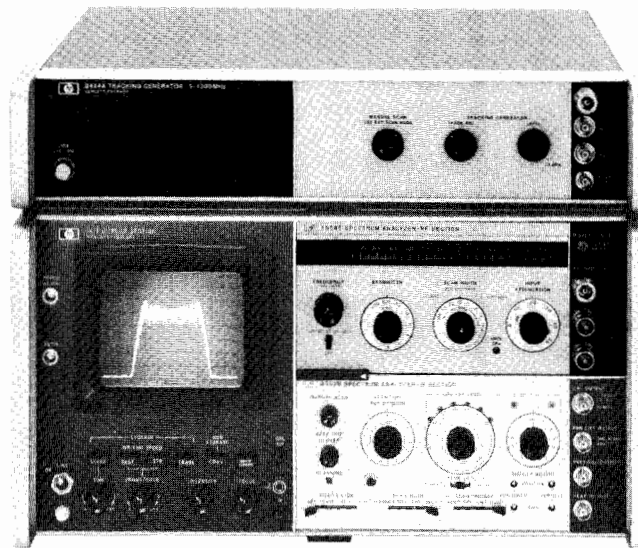

8554B Spectrum Analyzer

The 8554B Spectrum Analyzer RF Section covers the frequency range from 100 kHz to 1250 MHz. This broad frequency coverage allows analysis from baseband through UHF navigation bands. Absolute amplitude calibration is maintained over the entire range. Some typical applications include power and frequency measurements on modulation, distortion and spurious outputs, frequency response measurements of filters, amplifiers, modulators and mixers. The analyzer can also be used to make noise measurements such as noise power density over a specified frequency band, carrier-to-noise ratio or swept noise figure measurement of amplifiers. With a calibrated antenna or current probe the analyzer can characterize broadband and narrowband signals encountered in EMI applications.

Absolute Amplitude Calibration

Absolute amplitude measurements can be made from $+10$ to -122 dBm with ± 2.8 dB accuracy. This accuracy can be improved to ± 1.75 dB using IF substitution. The display is calibrated in log (dBm) to obtain a wide display range and linear (voltage) for measurements requiring maximum resolution. The top graticule line on the CRT is a calibrated reference level which can be changed by the front panel controls from $+10$ to -72 dBm for IF substitution measurements. Amplitude calibration is dependent upon the proper relationship between sweep width, sweep time, resolution bandwidth and video filtering. An uncal warning light is present to indicate an uncalibrated situation.

Flat Frequency Response

In broadband use, the wide bandwidths allow fast sweeping of the entire spectrum. The analyzer is extremely flat (± 1 dB) over its entire range, allowing direct comparisons of signal amplitudes displayed on the CRT. A 0 to 50 dB input attenuator is provided to prevent overdriving the input mixer.

Resolution

The low residual FM (< 100 Hz peak-to-peak) of the 8554B makes possible resolution bandwidths as narrow as 100 Hz. This enables resolving closely spaced signals such as 1 kHz and 400 Hz sidebands. Bandwidths range from 100 Hz to 300 kHz in a 1, 3, 10 sequence making it easy to select an optimum bandwidth to scan width ratio.

The resolution bandwidths consist of synchronously tuned "gaussian" shaped filters to enable faster sweeping for any given bandwidth. In addition, these filters have narrow shape factors making it possible to measure closely spaced signals differing greatly in amplitude.

Sensitivity

The high sensitivity (-122 dBm in 100 Hz bandwidth) and wide spurious-free measurement range (> 65 dB) of the 8554B means accurate measurements can be made on low level signals and signals varying widely in amplitude. For example, modulation as low as 0.2% can be measured. Low level harmonic and intermodulation distortion, spectrum surveillance and EMI are just a few of the measurements possible. A video filter is provided in the IF section to average displayed noise and simplify the measurement of low level signals.

Automatic Tuning Stabilization

The 8554B Spectrum Analyzer is automatically stabilized in narrow scans. This gives the stability (< 100 Hz peak-to-peak residual FM) needed for high resolution analysis. Stabilization is accomplished by phase locking the LOs (local oscillators) to a crystal reference in scan widths 200 kHz/div and below. No signal recentering or checking for stabilization is required because the signal remains on screen when phase locked.

8444A Tracking Generator

The 8444A Tracking Generator is a signal source, which, when connected to the 8554B Spectrum Analyzer, has an output whose frequency is the same as the swept frequency of the analyzer. The tracking generator is used as a signal source to measure the frequency response of a device. It can also be used for precision frequency measurements. An external counter output is provided on the 8444A and the frequency of unknown signals as well as the frequency of any point on a frequency response curve can be measured. The use of the 5300/5305B Counter is suggested for frequency measurements to 1300 MHz.

The tracking generator-spectrum analyzer system can be used as a sweeper to provide test signals for other devices. The sweep widths and sweep rates are controlled from the spectrum analyzer and the output level from the tracking generator.



8554B Specifications—with 8552B IF Section

Frequency Specifications

Frequency range: 100 kHz to 1250 MHz.

Scan width (on 10-division CRT horizontal axis)

Per division: 15 calibrated scan widths from 100 MHz/div to 2 kHz/div in a 1, 2, 5 sequence.

Preset: 0-1250 MHz, automatically selects 300 kHz bandwidth IF filter.

Zero: analyzer is fixed-tuned receiver.

Frequency Accuracy

Center frequency accuracy: The dial indicates the display center frequency within 10 MHz.

Scan width accuracy: frequency error between two points on the display is less than 10% of the indicated separation.

Resolution

Bandwidth: IF bandwidths of 0.1 to 300 kHz provided in a 1, 3, 10 sequence.

Bandwidth accuracy: individual IF bandwidth 3 dB points calibrated to $\pm 20\%$ (10 kHz bandwidth $\pm 5\%$).

Bandwidth selectivity: 60 dB/3 dB IF bandwidth ratio <20:1 for IF bandwidths from 10 kHz to 200 kHz. 60 dB/3 dB bandwidth ratio <11:1 for IF bandwidths 100 Hz to 3 kHz.

Stability (Residual FM)

Stabilized: <100 Hz peak-to-peak.

Unstabilized: <10 kHz peak-to-peak.

Noise sidebands: more than 70 dB below CW signal, 30 kHz or more away from signal, with 1 kHz IF bandwidth.

Amplitude Specifications

Absolute Amplitude Calibration Range

Log: from -122 to +10 dBm. 10 dB/div on a 70 dB display, or 2 dB/div on a 16 dB display.

Linear: from 0.1 μ V/div to 100 mV/div in a 1, 2 sequence on an 8-division display.

Dynamic Range

Average noise level: <-102 dBm with 10 kHz IF bandwidth.

Spurious responses: All image and out-of-band mixing responses, harmonic and intermodulation distortion products are more than 65 dB below a -40 dBm signal at the input mixer.

Residual responses (no signal present at input): with input attenuation at 0 dB: <-100 dBm.

Amplitude Accuracy

	Log	Linear
Frequency response (flatness)		
100 kHz to 1250 MHz	± 1 dB	$\pm 12\%$
Switching between bandwidths (at 25°C)	± 0.5 dB	$\pm 5.8\%$
Amplitude display	± 0.25 dB/dB but not more than ± 1.5 dB over the full 70 dB display range.	2.8% of full 8 div deflection

Calibrator Output

Amplitude: -30 dBm, ± 0.3 dB.

Frequency: 30 MHz, ± 3 kHz.

Log reference level control: provides 70 dB range (60 dB below 200 kHz), in 10 dB steps. Accurate to ± 0.2 dB ($\pm 2.3\%$, Linear Sensitivity).

Log reference level vernier: provides continuous 12 dB range. Accurate to ± 0.1 dB ($\pm 1.2\%$) in 0, -6, and -12 dB positions; otherwise ± 0.25 dB ($\pm 2.8\%$).

Amplitude measurement accuracy: ± 1.75 dB with proper technique.

RF Input Specifications

Input impedance: 50 Ω nominal. Typical reflection coefficient <0.30 (1.85 SWR), input attenuator ≥ 10 dB.

Maximum input level: peak or average power +13 dBm (1.4 V ac peak), ± 50 V dc.

General

Scan time: 16 internal scan rates from 0.1 ms/div to 10 sec/div in a 1, 2, 5 sequence, and manual scan.

Scan Time Accuracy

0.1 ms/div to 20 ms/div: $\pm 10\%$.

50 ms/div to 10 s/div: $\pm 20\%$.

Weight

Model 8554B RF section: net, 4.7 kg (10.3 lb). Shipping 7.8 kg (17 lb).

Size: 102 H x 226 W x 344 mm D (4" x 8.9" x 13.5").

8444A Specifications

Specifications for Swept Frequency Response

Measurements

Dynamic range: >90 dB from spectrum analyzer 1 dB gain compression point to average noise level (approximately -10 dBm to -100 dBm). Spurious responses not displayed.

Gain compression: for -10 dBm signal level at the input mixer, gain compression <1 dB.

Absolute Amplitude calibration range:

Tracking generator (drive level to test device: 0 to -10 dBm continuously variable. 0 dBm absolutely calibrated to ± 0.5 dB at 30 MHz).

Frequency range: 500 kHz to 1250 MHz.

Frequency resolution: 1 kHz.

Stability

Residual FM (peak-to-peak): stabilized, <200 Hz; unstabilized, <10 kHz.

Amplitude Accuracy

System Frequency response: ± 1.50 dB.

Tracking generator calibration: 0 dBm at 30 MHz to ± 0.5 dB.

Specifications for Precision Frequency Measurements

Frequency accuracy: for unknown signals ± 10 kHz. (Tracking drift typically 50 kHz/10 min after 2-hour warm-up). For points on frequency response curve, counter accuracy \pm Residual FM (200 Hz).

Counter Mode of Operation

Manual scan: scan determined either by front panel control of 8552B IF Section or by external scan signal provided by the 8444A.

Zero scan: analyzer is fixed-tuned receiver. Counter reads center frequency to accuracy of tracking drift.

Counter output level: typically 0.1 V rms.

Specifications for Sweep/CW Generator

Frequency: controlled by spectrum analyzer. Range 500 kHz to 1250 MHz with 8554B. Scan widths are as enumerated on this page.

Frequency accuracy: ± 10 MHz using spectrum analyzer tuning dial. Can be substantially improved using external counter output.

Flatness: ± 0.5 dB.

Spectral Purity

Residual FM (peak-to-peak): 200 Hz.

Harmonic distortion: 25 dB below output level (typical).

Nonharmonic (spurious) signals: >35 dB below output level.

Long term stability: drift typically less than 30 kHz/hour when stabilized after 2-hour warm-up.

Sweep width: 20 kHz to 1000 MHz.

Sweep rates: selected by Scan Time per Division on spectrum analyzer.

General

Temperature range: operation, 0°C to 55°C, storage -40°C to 75°C.

EMI: conducted and radiated interference is in compliance with MIL-STD 461A Methods CE03 and RE02 and CISPR publication 11 (1975).

Power: 115 V and 230 V, 48 to 440 Hz, 12 watts max.

Weight: net, 7.1 kg (15.6 lb). Shipping, 9.5 kg (21 lb).

Size: 88.2 H x 425 W x 467 mm D (3.5" x 16.8" x 18.4").

Ordering Information

8554B RF Section

Opt 003: Internal Limiter

8444A Tracking Generator

Price

\$6300

\$170

\$3950



SIGNAL ANALYZERS

141T Spectrum Analyzer System: 10 MHz to 40 GHz

Models 8555A, 8444A Option 059 & 8445B

- Absolute amplitude calibration
- High sensitivity to -125 dBm (125 nV)
- Resolve signals to 100 Hz
- Scan up to 8 GHz full screen
- 100 dB distortion free dynamic range with preselector
- Companion tracking generator to 1.5 GHz

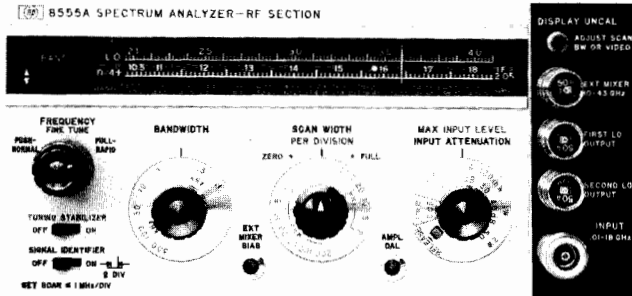

8555A

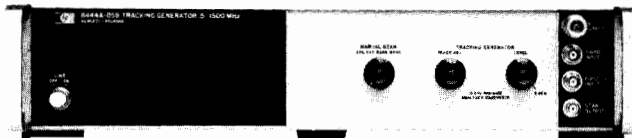

8444A Opt 059

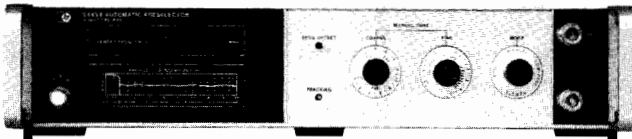

8445B Opt 002, 003



8555A Spectrum Analyzer

The 8555A Spectrum Analyzer covers 10 MHz to 18 GHz with fundamental and harmonic mixing. A single external waveguide mixer can provide 12.4 GHz to 40 GHz coverage. This broad frequency range coupled with its high sensitivity and resolution bandwidth allow a variety of power measurements, frequency measurements, modulation, and noise analysis on almost every type of design module: the frequency response of amplifiers, mixers, and modulators, response and alignment of filters, isolators, couplers and limiters. With wide scan widths and calibrated amplitude the 8555A is ideal for spectrum surveillance and RFI/EMC field strength analysis with a calibrated antenna.

Absolute Amplitude Calibration

The 8555A offers absolute amplitude calibration from +10 dBm to -125 dBm over the 10 MHz to 18 GHz frequency range. This capability makes possible not only absolute signal power measurements, but also the measurement of the power differential between two signals separated by as much as 18 GHz. The parallax-free CRT graticule can read as a log scale (dBm) or a linear scale (volts) with a frequency response accuracy of ± 1.5 dB to 6 GHz and ± 2.0 dB to 18 GHz. The top line of the display is established as the reference level by front panel controls. A light warns of an uncalibrated condition.

High Sensitivity

The high sensitivity from -125 dBm (fundamental mixing) to -100 dBm (4th harmonic) in a 100 Hz bandwidth makes it possible to measure large values of attenuation, out of band filter and ampli-

er response, weak transmitted signals in surveillance work or microvolt signals in EMC applications. A post-detection filter with 10 kHz, 100 Hz and 10 Hz positions averages noise and yields an extremely clean observed trace.

High Resolution

Due to low residual FM (< 100 Hz peak-to-peak) the 8555A offers outstanding 100 Hz resolution which allows the users to resolve closely spaced signals and low-level sidebands resulting from a 1 kHz modulating signal. The resolution capability makes it possible to analyze spurious low frequency modulation of microwave signals. The high stability of the analyzer results in more accurate measurements of residual FM, long-term drift, phase noise, and spectral purity. Furthermore, the gaussian shape of the IF filters allows fastest sweep for a given resolution bandwidth.

Automatic Tuning Stabilization

When scanning over a relatively narrow frequency range, the frequency stability of the analyzer's internal local oscillators becomes important for high resolution and frequency measurements. For this reason the 8555A is equipped with a tuning stabilizer circuit which automatically phase locks the analyzer to a crystal oscillator. Display jitter and signal recentering are virtually eliminated.

Added Input Mixer Protection

To prevent an inadvertent 0 dB setting of the input attenuator, a pushbutton lockout is provided on the attenuator knob.

8445B Tracking Preselector, 10 MHz to 18 GHz

The 8445B Tracking Preselector is a YIG tuned filter coupled to the 8555A Spectrum Analyzer in order to be tuned exactly to the analyzer's reception frequency. The preselector suppresses harmonic mixing image and multiple responses from 1.8 to 18 GHz. The result is a wide spurious free amplitude measurement range. Clean, full band sweeps are possible in scans of 2, 4, 6 or 8 GHz depending upon the band selected.

Below 1.8 GHz the image and multiple responses are eliminated by a low-pass filter in the preselector.

An optional five digit LED display with 1 MHz resolution allows accurate measurement of either the display frequency at the display marker in full scan mode or the center frequency in per division scan.

8444A Option 059 Tracking Generator

The 8444A Option 059 Tracking Generator provides a level, calibrated RF signal which is exactly the tuned frequency of the spectrum analyzer. This enables swept frequency tests such as frequency response and return loss measurements up to 1500 MHz. With an external counter the frequencies of unknown signals on points along a frequency response curve can be made.

8555A Specifications— with 8552B IF Section

Frequency Specifications

Frequency range: 0.01–40 GHz.

Tuning Range

With internal mixer: 0.01–18.0 GHz.

With external mixer: 12.4–40 GHz.

Harmonic Mixing Mode

Signal identification: not normally required with preselector. Signal identifier provided for positive identification of all responses. Rejection of images and multiple responses with preselector is > 70 dB.

Scan Width

Full scan: the width of the scan depends on mixing mode. Scan width = $n \times 2000$ MHz, where n is the mixing mode; e.g. for $n = 2$, scan width is 4 GHz. Maximum scan width full screen is 8 GHz with coaxial mixer. Preselector necessary to make wide scans usable.

Per division: 16 calibrated scan widths from 2 kHz/div to 200 MHz/div in a 2, 5, 10 sequence.

Zero scan: analyzer becomes fixed-tuned receiver.

Frequency Accuracy

Dial accuracy: $n \times (\pm 15 \text{ MHz})$ where n is the mixing mode.

Scan accuracy: frequency error between two points on the display is less than $\pm 10\%$ of the indicated separation.

Stability: residual FM stabilized < 100 Hz peak-to-peak (fundamental mixing).

Noise sidebands: for fundamental mixing. More than 70 dB below CW signal 30 kHz or more away from signal, with 1 kHz IF bandwidth and 100 Hz video filter.

Frequency Drift

Long term drift: at fixed center frequency after 2-hour warm-up (Typical).

Stabilized: $\pm 3.0 \text{ kHz}/10 \text{ min}$.

Unstabilized: $\pm 25 \text{ kHz}/10 \text{ min}$.

Stabilization range: first LO can be automatically stabilized to internal crystal reference for scan widths of 100 kHz/div or less.

Resolution

Bandwidth range: selectable 3 dB bandwidths from 100 Hz to 300 kHz in a 1, 3, 10 sequence.

Bandwidth shape: approximately gaussian.

Bandwidth selectivity: 11:1 to 20:1 (60 dB/3 dB).

Bandwidth accuracy: individual IF bandwidth 3 dB points calibrated to $\pm 20\%$ (10 kHz bandwidth, $\pm 5\%$).

Amplitude Specifications

Measurement Range

Log reference level: from -60 dBm to +10 dBm.

Linear sensitivity: from 0.1 $\mu\text{V}/\text{div}$ to 100 mV/div.

Sensitivity and frequency response with internal coaxial mixer noise level: specified for 1 kHz bandwidth.

Frequency response with 10 dB input attenuator setting:

Frequency Range (GHz)	Mixing Mode (n)	Average Noise Level (dBm max.)	Frequency Response* (dB max.)
0.01-2.05	1-	-115	± 1.0
1.50-3.55	1-	-117	± 1.0
2.07-6.15	2-	-108	± 1.3
2.60-4.65	1+	-117	± 1.0
4.11-6.15	1+	-115	± 1.0
4.13-10.25	3-	-103	± 1.5
6.17-10.25	2+	-105	± 1.5
6.19-14.35	4-	-95	± 2.0
8.23-14.35	3+	-100	± 2.0
10.29-18.00	4+	-90	± 2.0

*Includes mixer frequency response, RF attenuator frequency response, mixing mode gain variation, RF input VSWR.

Sensitivity and frequency response with 11517A external waveguide mixer and appropriate waveguide tapers

Average noise level 10 kHz bandwidth (dBm typical):

Frequency Range (GHz)	Mixing Mode (n)	Average Noise Level (dBm)
12.4-18.0	6-	-90
18.0-26.5	6+	-85
26.5-40.0	10+	-75

Frequency response: typically $\pm 3 \text{ dB}$ over 1 GHz frequency scans.

Residual responses: referred to input on fundamental mixing; < -90 dBm.

Display Range

Log: 70 dB, 10 dB/div and 2 dB/div, expanded on a 16 dB display.

Linear: from 0.1 $\mu\text{V}/\text{div}$ to 100 mV/div in a 1, 2, sequence on an 8-division display.

Spurious responses due to second harmonic distortion with preselector:

Frequency Range	Power Incident on Input Mixer	2nd Harmonic Distortion
0.01-1.85 GHz	-40 dBm	-63 dB
1.85-18.0 GHz	0 dBm	-100 dB

Spurious responses due to third order intermodulation distortion with preselector

Frequency Range	Signal Separation	Power Incident on Input Mixer	Third Order Intermodulation Distortion
0.01-18.0 GHz	> 1 MHz < 20 MHz	-30 dBm	-70 dB
0.01-1.85 GHz	> 70 MHz	-30 dBm	-70 dB
1.85-18.0 GHz	> 70 MHz	0 dBm	-100 dB

Video filter: post detection filter used to average displayed noise. Nominal bandwidths: 10 kHz, 100 Hz, and 10 Hz.

Gain compression: for internal mixer gain compression < 1 dB for -10 dBm peak or average signal level to input mixer. 11517A External Mixer (12.4-40 GHz) gain compression < 1 dB for -15 dBm peak or average signal level to input mixer.

Amplitude Accuracy

IF gain variation with different bandwidth settings: (at 20°C.)

Log: $\pm 0.5 \text{ dB}$.

Linear: $\pm 5.8\%$

SIGNAL ANALYZERS

141T Spectrum Analyzer System: 10 MHz to 40 GHz

Models 8555A, 8444A & 8445B (cont.)

Amplitude Display

Log: ± 0.25 dB/dB, but not more than ± 1.5 dB over the full 70 dB display range.

Linear: $\pm 2.8\%$ of full 8-division deflection.

Log reference level: accurate to ± 0.2 dB ($\pm 2.3\%$ linear sensitivity).

Log reference level vernier: accurate to ± 0.1 dB (1.2%) in 0, -6, and -12 dB positions; otherwise, ± 0.25 dB ($\pm 2.8\%$).

Input attenuator range: 0-50 dB in 10 dB steps, manual safety lock-out for 0 dB position.

Frequency response: typically ± 0.6 dB from 10 MHz to 18 GHz.

Calibrator output: amplitude -30 dBm, ± 0.3 dB. Frequency 30 MHz ± 3 kHz.

Absolute calibration accuracy: overall accuracy is a function of measurement technique. With the appropriate technique, absolute accuracy of ± 1.6 dB (fundamental mixing) and ± 2.6 dB (4th harmonic mixing) is achievable.

Input Characteristics

Input impedance: 50 ohms nominal (0.01-18 GHz).

Reflection coefficient: < 0.130 (1.30 SWR) for input RF attenuator settings ≥ 10 dB.

Maximum input level: peak or average power +13 dBm (1.0 V ac rms) incident on mixer (+30 dBm with Opt 002), +33 dBm incident on input attenuator.

RF input connector: type N female.

LO emission: -10 dBm without preselector, -80 dBm with preselector over recommended operating ranges (10 dB input attenuator setting).

General

Scan time: 16 internal scan rates from 0.1 ms/div to 10 sec/div in a 1, 2, 5 sequence.

Power requirements: 100, 120, 220 240 V +5%, -10%, 50-60 Hz, normally less than 225 watts (varies with plug-in units used).

Weight: net, 16.8 kg (14.9 lb). Shipping, 8.7 kg (19 lb).

Size: 102 H x 226 W x 344 mm D (4" x 8.9" x 13.5").

Specifications with Option 002;

Internal Limiter Installed

All specifications are the same as for the standard unit except the following:

Frequency range: 0.1-12.4 GHz, usable over 0.01-18 GHz range.

Maximum Input Level

Continuous: 1 W (+30 dBm).

Pulse: 75 watts peak, pulse width ≤ 1 μ s, 0.001 duty cycle.

Reflection coefficient: < 0.33 (2.0 SWR).

Frequency response (flatness): $< \pm 0.5$ dB degradation in response, 0.1-12.4 GHz.

8445B Tracking Preselector

Frequency Specifications

Frequency range: dc-1.8 GHz low-pass filter. 1.8-18 GHz tracking filter.

Tracking filter 3 dB bandwidth: typically 20-45 MHz.

Tracking filter skirt roll-off: characteristics of a three-pole filter. (Nominal: 18 dB/octave.)

Insertion Loss

	Frequency	Insertion Loss (Except Opt. 004)	Insertion Loss (Opt. 004)
Low-Pass Filter	DC-1.8 GHz	< 2.5 dB	*
	@2.05 GHz	> 50 dB	*
Tracking Filter	1.8-12 GHz	< 8 dB	< 7 dB
	12-18 GHz	< 10 dB	< 8 dB

*Low-Pass Filter deleted with Opt 004.

Typical preselector minimum insertion loss at 25°C.

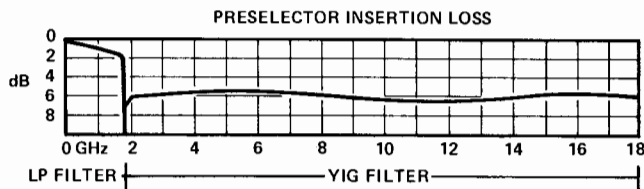

Out-of-band rejection: for YIG filter 1 GHz from center of pass-band > 70 dB.

Digital frequency readout (Option 003):

Function:

Full scan mode: displays frequency at inverted marker.

Per division scan: displays center frequency.

Manual or remote operation of preselector: displays tuned frequency of filter.

Resolution: 1 MHz.

Accuracy: 0.01-1.0 GHz: ± 6 MHz.

1.0-4.0 GHz: ± 8 MHz.

4.0-18 GHz: $\pm 0.2\%$

Input Specifications

Input connector: precision Type N female.

Input VSWR: typically < 2.0 (1.8-18 GHz).

Limiting level: (maximum input level for < 1 dB signal compression), $> +5$ dBm.

Damage level: $> +20$ dBm.

General

Remote function: YIG filter frequency can be set by externally supplied voltage.

Power requirements: 100, 120, 220, or 240 V + 5%, -10%, 48 to 440 Hz, less than 110 watts.

Weight: net, 8.8 kg (19.5 lb). Shipping, 11.9 kg (26 lb).

Size: 88.2 H x 425 W x 467 mm D (3.5" x 16.8" x 18.4").

8444A Opt 059 Tracking Generator

Frequency range: 0.5 MHz to 1500 MHz.

Frequency resolution: 1 kHz.

Residual FM (peak-to-peak): 200 Hz (stabilized).

Amplitude Range

Spectrum analyzer display: from -130 dBm to +10 dBm, 10 dB/div on a 70 dB display or 2 dB/div on a 16 dB display (8552B only).

Tracking generator (drive level to test device): 0 to -10 dBm continuously variable.

Amplitude Accuracy

System frequency response: ± 2.7 dB.

Tracking generator calibration: 0 dBm at 30 MHz to ± 0.5 dB.

Dynamic range: > 90 dB.

Counter output: typically 0.1 V rms.

General

Power: 115 V and 230 V, 48 to 440 Hz, 12 watts max.

Weight: net, 7.1 kg (15.6 lb). Shipping, 9.5 kg (21 lb).

Size: 85.2 H x 425 W x 467 mm D (3.5" x 16.8" x 18.4").

Ordering Information

8555A Tuning Section	\$9600
Opt 001: APC-7 connectors	add \$40
Opt 002: Internal limiter	add \$210
Opt 005: Video tape	add \$105

8445B Tracking Preselector, dc -18GHz	\$5450
Opt 001: APC-7 connectors	add \$155
Opt 002: Add manual controls	add \$80
Opt 003: Add digital frequency readout	add \$670
Opt 004: Delete low-pass filter	less \$425
Opt 005: Delete interconnect rigid coax	less \$50

8444A Opt 059 Tracking Generator	\$4450
11517A External Mixer (taper section req'd)	\$300
11518A Taper Section, 12.4 to 18 GHz	\$195
11519A Taper Section, 18 to 26.5 GHz	\$195
11520A Taper Section, 26.5 to 40 GHz	\$195

SIGNAL ANALYZERS

Spectrum Analyzer Accessories

Models 8750A, 8447 Series, 11694A & 1121A

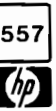

11694A

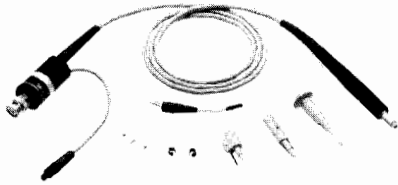

1121A

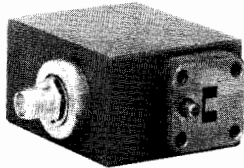

11517A



11693A



11867A

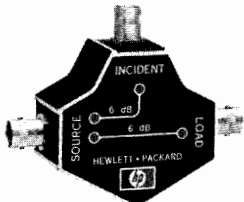

8721A

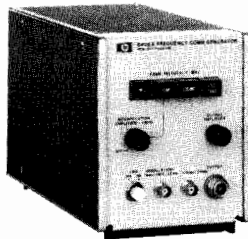

8406A

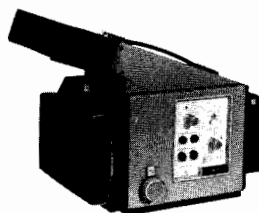

197B

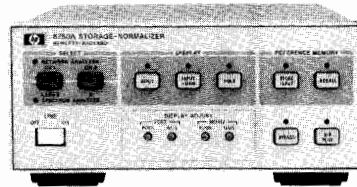

8750A

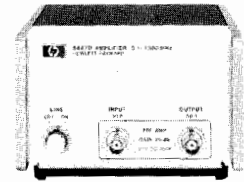

8447 Series

8750A Storage-Normalizer

The 8750A is directly compatible with the HP 8557A, 8558B, 8559A, and 8565A Spectrum Analyzers, as well as most HP network analyzers, and requires a conventional low-frequency oscilloscope to be used with the 140 series analyzers. (See page 501).

8447 Series Amplifiers (0.1-1300 MHz)

The 8447 Series Amplifiers feature low noise and wide bandwidth. This makes them ideal for improving spectrum analyzer sensitivity and noise figure while providing input isolation. Accurate measurements over a wide frequency range are assured due to the broad frequency coverage, flat frequency response and low distortion of these amplifiers. (See page 67).

11694A 75Ω Matching Transformer (3-500 MHz)

Allows measurement in 75-ohm systems while retaining amplitude calibration. VSWR is less than 1.2, and insertion loss is less than 0.75 dB. Note: Also see Options 001 and 002 for 75Ω versions of 8557A and 8558B.

1121A Active Probe (0.1-500 MHz)

Provides high impedance (>100 kΩ shunted by <3 pF) input to spectrum analyzer for measurements on sensitive circuits. Probe power is supplied by most HP Spectrum Analyzers and flat response with unity gain assures accurate, convenient measurements. (See page 499).

11517A External Mixer

To extend the frequency range of the 8555A, 8565A and 8566A analyzers to 40 GHz (for use with 8566A, order 11517A, Opt E02). Taper sections for 12.4-18 GHz (11518A), 18-26.5 GHz (11519A) or 26.5-40 GHz (11520A) bands are required.

11693A Limiter (0.1-12.4 GHz)

The Model 11693A Limiter provides input protection for a variety of instruments in general applications (usable from 0.01 to 18 GHz). For example, the input circuits of spectrum analyzers, samplers, or amplifiers may be protected for inputs up to 75 watts peak or 1 watt average power. Also, signal generators can be protected from application of reverse power.

11867A RF Limiter (DC-1800 MHz)

The 11867A is a general purpose diode limiter designed to provide input protection from inadvertent strong signal overloads. Absolute amplitude calibration is maintained with flatness degraded < ±0.25 dB and insertion loss < 0.75 dB. 10 watts average or 100 watts peak power can be tolerated.

8721A Directional Bridge

For making return loss measurements from 100 kHz to 110 MHz. (See page 499 under "11652A: Directional Bridge").

8406A Frequency Comb Generator

Produces frequency markers at 1, 10, and 100 MHz increments accurate to ±0.01%. External oscillator can be used to generate precision interpolation sidebands. Comb is usable to beyond 5 GHz.

197B Oscilloscope Camera

For a permanent record of your measurements. (See page 231 for necessary adapters).

Ordering Information

Ordering Information	Price
11694A 75Ω Matching Transformer	\$75
11517A External Mixer (Mixer only)	\$300
11518A/11519A/11520A Waveguide Taper Sections	\$195
11693A Limiter	\$400
11867A RF Limiter	\$300
8406A Frequency Comb Generator	\$1745
8750A Storage-Normalizer	\$1750

SIGNAL ANALYZERS

5 Hz to 50 kHz Spectrum Analyzer

Model 3580A

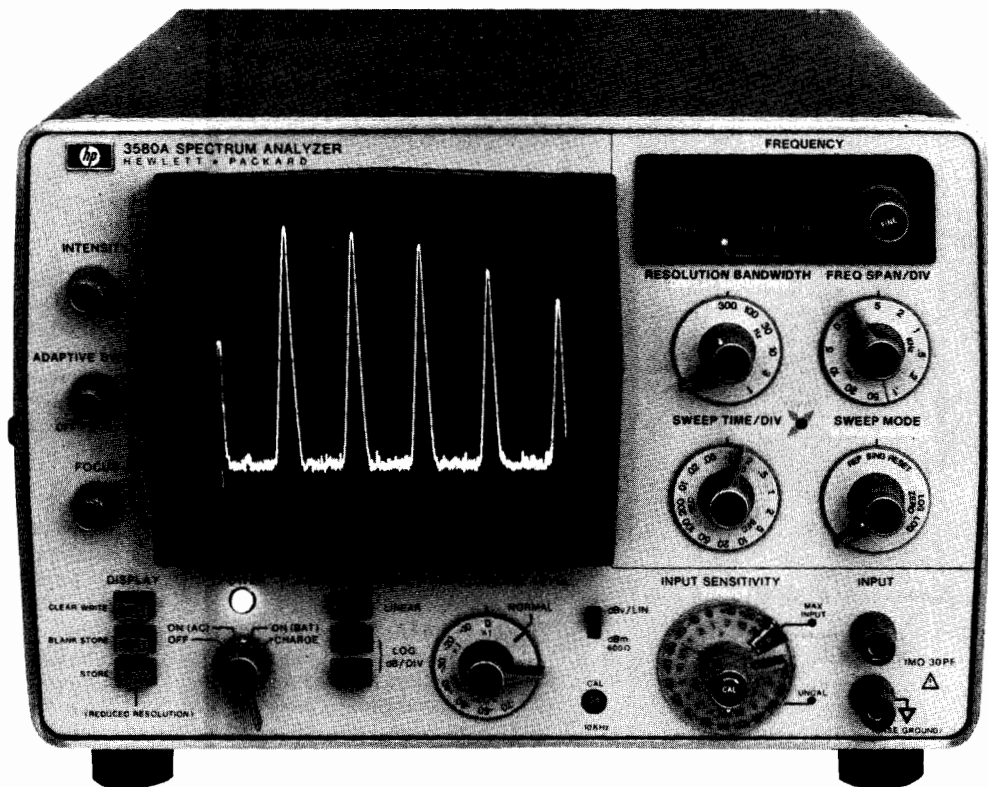

Description

Hewlett Packard's 3580A Spectrum Analyzer is a low frequency high performance analyzer. Its 1 Hz bandwidth allows the user to examine noise and extraneous signal content close in to a signal of interest.

For low frequency applications where sweep speeds can be slow and time-consuming, a special feature, adaptive sweep, allows the user to set a threshold above which only the spectra of interest are observed. In this mode, the CRT is rapidly swept. When a signal is encountered, the sweep slows down to reproduce full response. A factor of ten speed gain is possible.

Digital storage is another important feature which enhances the display for slowly swept low frequency signals. The analyzed signals are digitized and stored in memory. Trace information is then read from memory at a rate appropriate for obtaining an analog-like display.

Digital Storage for Spectra Comparison

Digital storage makes it possible to store one or two traces. When two are stored, both may be simultaneously displayed for easy comparison as shown below.

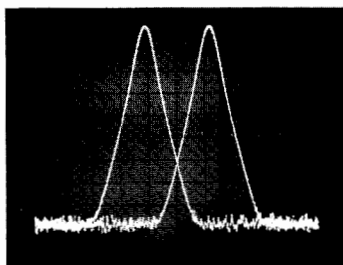

Adaptive Sweep

A tremendous savings in sweep time can be achieved by using adaptive sweep. In the left trace below, over 80 dB of dynamic range is used to look at low level signals and noise. Two hundred seconds were required to make the sweep. In the right trace, the baseline is raised to give 50 dB of dynamic range. Noise and other responses are not analyzed so the sweep now takes only 14 seconds.

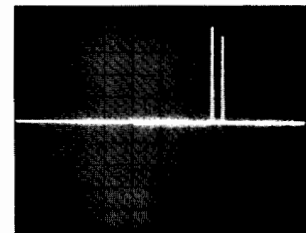
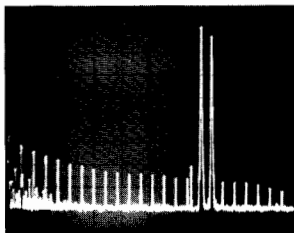

1 Hz Bandwidth

When using a 1 Hz bandwidth 60 Hz line related spectra are clearly exposed as shown in the left trace. An analysis of the same signal with a 10 Hz bandwidth will not resolve the line related spectra as shown on the right.

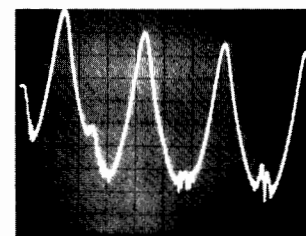
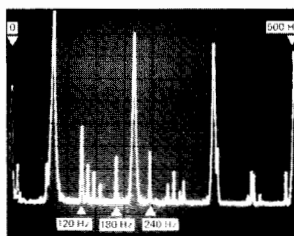



Digital Frequency Display

This display provides 1 Hz resolution for setting analysis range and for determining tuned frequency. In the automatic sweep modes, the sweep start or center frequency is displayed. In the manual sweep mode, actual tuned frequency is indicated. This mode effectively provides a cursor function for easy and accurate determination of the frequency at any point on the screen.

Internal Calibration Signal

A 10 kHz pulse derived from a crystal can be used to compensate for internal errors. A 10 kHz calibration potentiometer is provided so the 10 kHz fundamental can be adjusted to fall on the top line of the display. With this feature, operation and calibration can be verified for most of the instrument.



Specifications

Frequency Characteristics

Range: 5 Hz to 50 kHz.

Digital Frequency Display:

Resolution: 1 Hz

Accuracy: ± 3.5 Hz, 0 to 55°C.

Typical stability: ± 10 Hz/hr after 1 hour; ± 5 Hz/°C.

Bandwidths: (accuracy $\pm 15\%$)	1 Hz (25°C $\pm 5^\circ$ C)	3 Hz	10 Hz	30 Hz	100 Hz	300 Hz
	Shape factor:					10

Out of range blank: if controls are set so portions of displayed signal lie below 0 Hz or above 50 kHz, the baseline is displayed.

Amplitude Characteristics

Overall instrument range:

Linear: 20 V –100 nV full scale
Log: +30 dBm or dB V;
–150 dBm or dB V

Amplitude accuracy:	Log	Linear
Frequency response:		
20 Hz–20 kHz	$\pm .3$ dB	$\pm 3\%$
5 Hz–50 kHz	$\pm .5$ dB	$\pm 5\%$
Switching between bandwidths (25°C):		
3 Hz–300 Hz	$\pm .5$ dB	$\pm 5\%$
1 Hz–300 Hz	± 1 dB	$\pm 10\%$
Amplitude display	± 2 dB	$\pm 2\%$
Input attenuator	$\pm .3$ dB	$\pm 3\%$
Amplitude reference level: (IF attenuator)		
Most sensitive range	± 1 dB	$\pm 10\%$
All other ranges	± 1 dB	$\pm 3\%$

Dynamic range: 80 dB

IF feedthru: input level > 10 V, -60 dB; < 10 V, -70 dB.

Spurious responses: > 80 dB below input reference level.

Smoothing: 3 positions, rolloff is a function of bandwidth.

Overload indicator: this LED indicator warns of possible input amplifier overloading. Without this indication it would be possible to introduce spurious responses without knowing it.

Sweep Characteristics

Scan width: 50 Hz to 50 kHz.

Log sweep: 20 Hz to 43 kHz $\pm 20\%$ after 3 sweeps.

Sweep times: .1 sec to 2000 sec.

Rep: Repetitive sweeps over the specified band.

Reset: Resets to the beginning of the sweep—used to adjust start or center frequency.

Manual: in combination with the concentric knob, manual sweep fully duplicates the span of the electronic sweep.

Adaptive sweep: when in adaptive sweep below the threshold level, scan speed is 20 to 25 times faster. Threshold is adjustable to cover 0–60% of screen. Signals greater than about 6 dB above threshold are detected and swept slowly.

Sweep error light: this LED indicates a sweep that is too fast to capture full response. When the light is on, response can be $> 5\%$ lower than it should.

Zero scan: to look at the time varying signal at the center or start frequency within the bandwidth selected, the zero scan is used.

Output Characteristics

Tracking generator output: (also known as BFO or tracking oscillator output).

Range: 0 to 1 V rms into 600 Ω .

Frequency response: $\pm 3\%$, 5 Hz to 50 kHz.

Impedance: 600 Ω .

Total harmonic and spurious content: 40 dB below 1 volt signal level.

X-Y Recorder Analog Outputs

Vertical: 0 to +5 V $\pm 2.5\%$.

Horizontal: 0 to +5 V $\pm 2.5\%$.

Impedance: 1 k Ω .

Pen lift: contact closure to ground during sweep.

Size: 203.2 mm H x 412.8 mm W x 285.8 mm D (8" x 16 $\frac{1}{4}$ " x 11 $\frac{1}{4}$ ").

Weight: net, 12.25 kg (27 lb); 3580A Opt 001: net, 15.88 kg (35 lb).

Temperature range: 0°C to 55°C.

Power: 100 V, 120 V, 220 V, or 240 V $+5\%$ -10% . 48 to 440 Hz, 35 VA max.

Opt 001 battery: 5 hours from full charge. 14 hours to fully recharge. The internal battery is protected from deep discharge by an automatic turn off. Useful life of batteries is over 100 cycles.

Ordering Information

Opt 001: internal rechargeable battery

Price

add \$500

Opt 002: balanced input

add \$150

3580A Spectrum Analyzer

\$5750

SIGNAL ANALYZERS

Dual-Channel, Dynamic Signal Analyzer 0.02 Hz to 25.5 kHz

Model 3582A

- Transfer function magnitude and phase measurements
- Coherence function measurement
- Phase spectrum measurement
- Transient capture and frequency domain analysis
- Internal periodic and random noise source
- Band selectable analysis for 0.02 Hz resolution
- Alphanumeric CRT annotation and marker readout

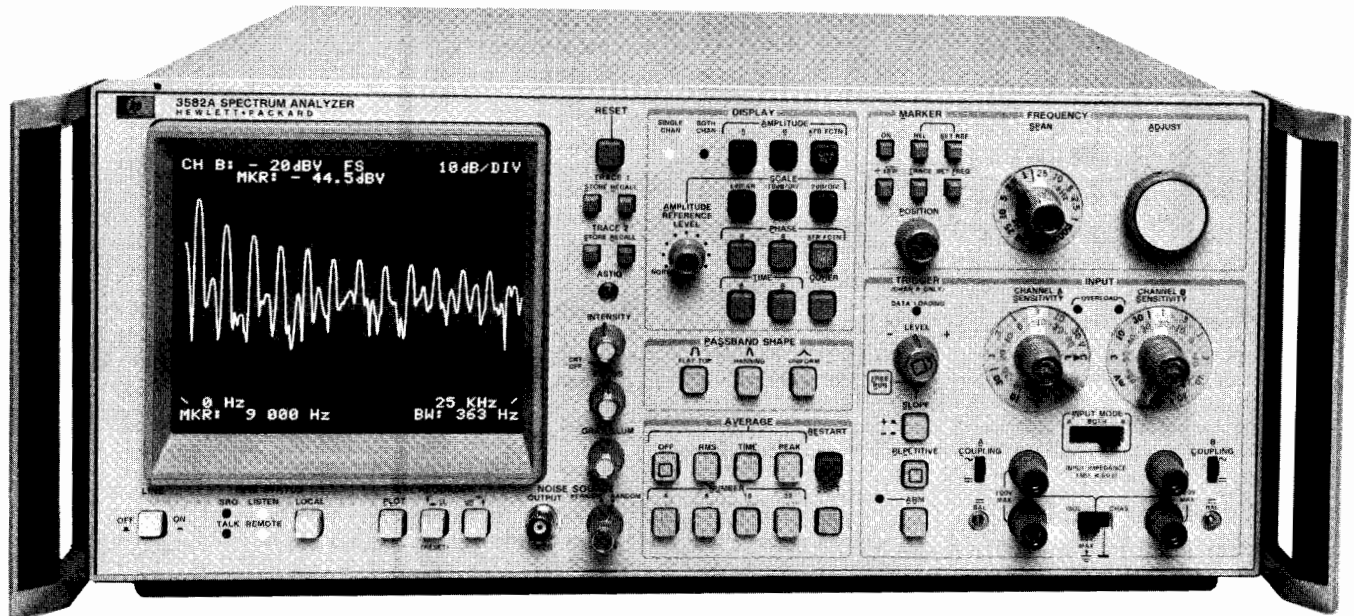

Description

The 3582A is a powerful dual-channel, real-time spectrum analyzer that solves bench or systems measurement problems in the frequency range of 0.02 Hz to 25.599 kHz. Sophisticated LSI digital filtering combined with microcomputer execution of the Fast Fourier Transform (FFT) provides exceptional measurement capability and performance.

Exceptional Frequency Resolution

The ability to resolve closely spaced spectral components is often critical in the study of subtle phenomena such as structural transfer functions. Unlike conventional dynamic signal analysis which extends from DC to some maximum frequency, the Model 3582A can "zoom in" to analyze any selected band of frequencies with dramatically improved resolution. The start or center frequency of the 5 Hz to 25 kHz band analysis spans can be adjusted in 1 Hz increments to cover the entire frequency range of the instrument. This provides resolution down to 20 milliHertz across the entire range for spectrum analysis or 40 milliHertz for transfer functions, representing as much as 5000 to 1 improvement over conventional "baseband" analysis.

Excellent Low Frequency Coverage

Many electrical and physical measurements have significant spectral information in the audio and sub-audio range. With frequency ranges from 25 kHz down to 1 Hz full scale, the Model 3582A is extremely well suited to these types of measurements. The display shown in fig. 1 represents the phase noise of a frequency synthesizer over the range of 0 to 1 Hz with a frequency resolution of 6 milli-Hertz.

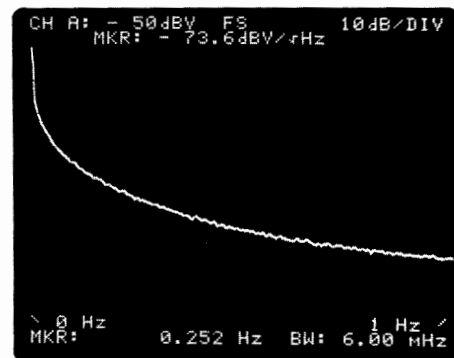

Figure 1: Phase Noise Measurement

Real Time Measurement Speed

Long measurement times can be a major limitation of swept low frequency spectrum analyzers. In high volume testing or in applications requiring substantial on-line tuning these long measurement times are both expensive and inconvenient. Since the Model 3582A uses an advanced microcomputer to execute the Fast Fourier Transform (FFT), it can perform equivalent measurements as much as one to two orders of magnitude faster than a swept analyzer.

Wide Amplitude Range

When examining the sensitivity of an analyzer, it is important to consider the full range of potential applications. If the analyzer does not directly cover the range of anticipated signals, external amplifiers or attenuators will be required. These devices can add their own noise and can distort the signal being measured. The Model 3582A offers 150 dB of calibrated measurement range covering +30 dBV (31.6 volts) to -120 dBV (1 μ volt) and thus minimizes the need for external signal conditioning. Even with input sensitivities down to -120 dBV the input circuit is fully protected against accidental overloads of 100 Volts DC or 120 Volts RMS for short periods.

Wide Dynamic Range

In many applications the information of interest is contained not in the high amplitude fundamental, but rather in the low amplitude components. For a spectrum analyzer to provide useful information about these low level components in the presence of a large signal, it must offer wide dynamic range. The Model 3582A dynamic range is specified as 70 dB.

Phase Spectrum Measurement

Most spectrum analyzers can measure only the amplitude spectrum of a signal, yet complete characterization in the frequency domain also requires phase information. Signals with identical amplitude spectra, but different phase spectra can differ significantly. The advanced digital signal processing techniques incorporated in the Model 3582A provide direct measurement of phase spectra.

Transient Capture and Analysis

Many signals such as mechanical shocks and electrical transients may occur infrequently and spontaneously and may last only for a brief period of time. Swept spectrum analyzers generally cannot handle these transient signals. By using digital processing techniques, the Model 3582A can capture and analyze transients as short as a few milliseconds. This means that spectrum analysis and transfer function analysis are no longer limited to stable, time invariant signals.

Transfer Function Measurement With the Internal Noise Source

Many electrical circuits and mechanical systems can be treated as linear networks and can be characterized by the magnitude and phase of their transfer functions.

Most spectrum analyzers can measure only the magnitude portion of the transfer function—and even then only by assuming a flat drive signal. The Model 3582A directly measures the complete transfer function, both magnitude and phase. With dual channels the actual drive signal is measured on Channel A and thus does not have to be totally flat; drive signal variations are taken out in the computation process to give valid results. The major constraint on the input signal is that, unlike a swept source, it must stimulate all frequencies of interest simultaneously. Two sources are provided in the Model 3582A which meet this constraint. They are pseudo-random and random noise. For linear networks, the pseudo-random noise source gives you accurate results in the fastest theoretically possible time. When nonlinearities are a problem, random noise gives the best estimate of the transfer function at the operating point. In addition, both noise sources are bandlimited to concentrate all stimulus energy in the band of frequencies analyzed. This minimizes test time because it improves the signal to noise ratio of the measurements. This also minimizes the disturbance to the network under test, which can be very important in control applications.

With this drive signal functioning as a "tracking generator" substitute, the Model 3582A is a low frequency network analyzer with "real-time" measurement speed. As with spectrum measurements, portions of the transfer function as narrow as 5 Hz can be examined anywhere over the 25 kHz frequency range.

Option 001 for the 3582A improves the transfer function measurement below 5 kHz. The accuracy for this option is ± 0.4 dB and $\pm 2^\circ$ as compared to ± 0.8 dB and $\pm 5^\circ$ for the standard instrument.

Coherence Function Measurement

The measurement of a device transfer function assumes that the device under test is linear and that no portion of the output is caused by noise or extraneous signal sources. In active electronic circuits or mechanical structures these conditions can easily be violated - yet such violations are very difficult to identify. The Model 3582A considerably simplifies this problem by providing the direct measurement of the coherence function. This is a frequency domain measure of the fraction of the power in one signal (e.g., the output) caused by the other measured signal (e.g., the input). If this fraction is 1.0, the output at that frequency is caused by the input and the transfer function is valid. If the fraction is near 0.0, the output is caused by something other than the measured input. This cause could be noise, nonlinearities or an unanticipated input, but the result is the same - the transfer function data at that frequency is suspect.

In addition to serving as a valuable check on the validity of transfer functions, the coherence function can be useful when investigating cause/effect relationships particularly in multiple input systems.

Digital Averaging Capability

Many spectral measurements contain both discrete signals and random noise components. Obtaining proper amplitude readings can be difficult if the random components are really the ones of interest or are of nearly the same amplitude as the discrete signals.

The digital averaging techniques incorporated in the Model 3582A help solve these problems. The RMS averaging mode takes the power average of 4 to 256 successive spectra in order to reduce the uncertainty of the estimate of random spectral components. For measurements where the spectral information is not stable but varies slowly with time, a running exponential form of RMS averaging is provided. By continually reducing the importance of older spectra, this mode prevents old data from completely obscuring new data yet still retains the basic advantages of averaging.

When a synchronizing trigger signal is available, the TIME average can enhance the signal-to-noise ratio by as much as 24 dB. Since it involves the averaging of successive time records before transformation it is also significantly faster than other types of averaging.

Fig. 2A

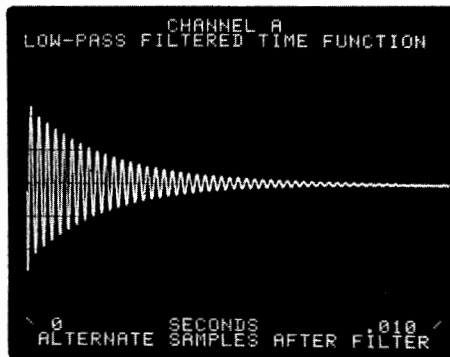
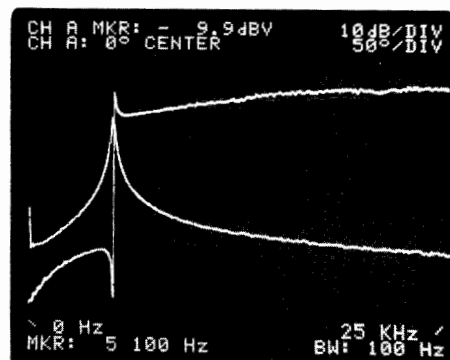

Fig. 2B



Figures 2A & 2B: Capture and analyze transients in both amplitude and phase.



SIGNAL ANALYZERS

Dual-Channel, Dynamic Signal Analyzer 0.02 Hz to 25.5 kHz

Model 3582A (cont.)

Fully Annotated, Calibrated CRT Display

One of the most important features of the Model 3582A is its ease of use. Operator interaction with the instrument is simplified by the combination of intelligent microcomputer control and the alphanumeric display capability. The basic annotation clearly shows the major measurement parameters.

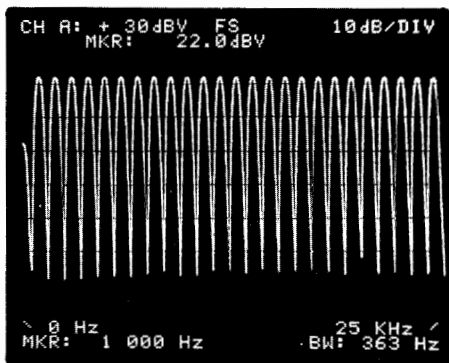

Figure 3: Fully Annotated, Calibrated Display with Calibration Signal Displayed

Powerful Marker Operations

The intensified dot marker is a major operational convenience. When active, the frequency and corresponding amplitude, phase or coherence value of the dot, are displayed alphanumerically on the display. Since the results are calibrated, there is no need to go through the time consuming, error-prone process of visually interpreting display points.

For operations such as determining frequency and amplitude separation, the marker can read out in units relative to a previous marker setting which was defined as a reference point.

When making band analysis measurements, the marker can be used in place of the frequency adjust control to define a new start or center analysis frequency.

Digital Trace Storage

Two independent information traces can be stored in digital memory for later recall and comparison.

Operational Diagnostics

In addition to measurement results, the display is used to provide the operator with useful diagnostics. As the examples show, these tend to not only indicate the problem, but also to suggest an appropriate action.

Fig. 4A

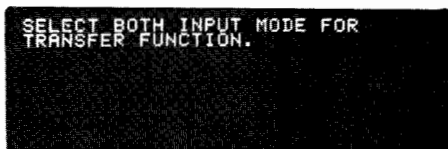

Fig. 4B



Figures 4A & 4B: Operational diagnostics not only show problem but also suggest solution

Service Diagnostics

By pressing combinations of front panel keys, the instrument will run self-diagnostic routines. These include a test of all the ROM, RAM, front panel, display, recorder output and the digital filters. The test results are displayed on the CRT as either "OK" (correct) or "ER" (error).

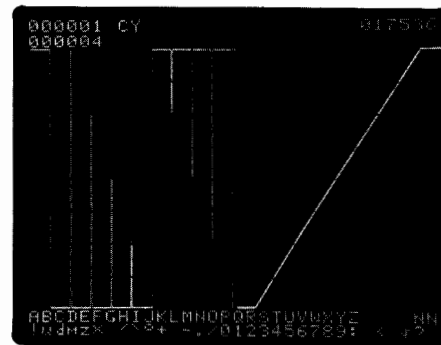

Figure 5: One of Several Self-Diagnostic Routines

Powerful HP-IB Capability

The Hewlett-Packard Interface Bus (HP-IB) is an interface concept that allows two-way communication among as many as fifteen different devices. Generally, at least one of these devices is a "computing controller" which exercises overall system control. This controller directs and coordinates the activities of the other devices in the system.

All major front panel controls with the exception of the verniers are fully programmable via the HP-IB. The programming codes are simple and are logically derived from the front panel control labels. The states of the various controls occupy only ten 8-bit bytes of data that can be read and written by the HP-IB. This allows you to manually set up a test from the front panel and store it in a compact form.

From the HP-IB it is a simple matter to command the Model 3582A to output results in a usable form. Not only can the various control settings be retrieved, but numeric marker data can be extracted. More importantly, the full display can be read in ASCII format along with complete annotation.

The HP-IB structure is entirely flexible, allowing any of the RAM (random access memory) in the instrument to be read or written into. This means that intermediate computational results such as the cross power spectrum can be read by a computing controller. In applications where speed is critical, the controller can transfer the displayed traces in binary, direct from the RAM. The ability to write into the RAM is also extremely valuable. For example, a perfect time record can be synthesized from a mathematical model and input to the instrument for analysis. More importantly, stored display information such as the vibration signatures of a rotating machine can be input to the instrument for review. Also, the controller can mathematically process the stored data and format the results for display on the CRT. Since the controller can also write its own four lines of alphanumeric text, the results can be properly annotated and calibrated. The operator can even be given brief interpretation instructions—all on the CRT of the instrument.

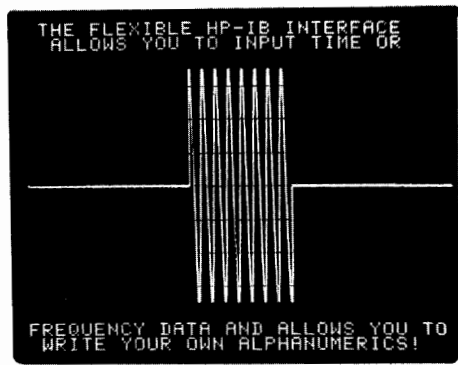

Figure 6:
Special Displays Are Possible Under HP-IB Control

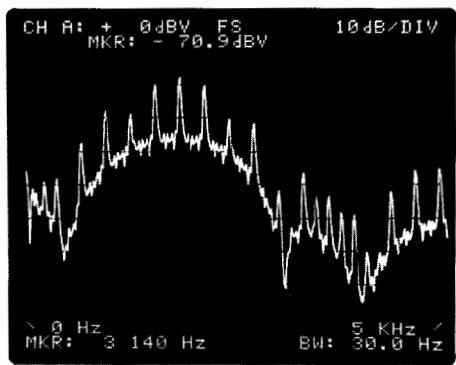

Figure 8
Modem Spectrum

A Wide Range of Applications Including:

**• Low frequency electronics
Characterize Signal Sources**

Spectrum analyzers have typically been of major value in characterizing the harmonic distortion, spurious outputs, level and frequency of signal sources. The model 3582A not only makes these measurements better and more accurately than before, but it also makes them faster. The additional combination of "real-time" measurement speed and the powerful HP-IB capability make automated testing of these parameters very attractive.

Phase Noise Measurement

In addition to characterizing low frequency sources, the Model 3582A can help characterize the short term random frequency fluctuations of a precision high frequency source. This is accomplished by mixing the high frequency signal down to DC and measuring the phase noise close-in to the carrier.

Filter Measurement

With direct transfer function measurements and the built-in driving source, the Model 3582A is well suited to performing a network analysis of low frequency devices such as filters. Figure 7 shows a five section low pass elliptic filter.

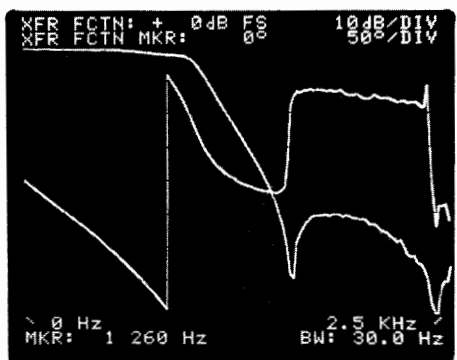

Figure 7:
Filter Transfer Function

• Telecommunications

The frequency range and performance characteristics of the Model 3582A are well matched to the R&D and production needs of telecommunications. Voice frequency components including analog lines can be easily characterized.

Specialized signal sources such as multifrequency tone sources and modems can pose unusual testing problems. Figure 8 shows the frequency spectrum of a modem transmitting a string of asterisks.

Audio and Acoustics

Tape Recorder Flutter

The Model 3582A has a number of features that make it well suited to the analysis of entertainment products. For example, an audio tape recorder is a moderately complex electromechanical system. Any unwanted mechanical speed variations will show up as discrete modulation sidebands on a recorded tone. With the frequency resolution of the Model 3582A, it is possible to identify the sidebands precisely enough to relate them to actual geometries.

Loudspeaker Testing

Loudspeakers provide another interesting application example. By combining the built-in noise source with time averaging, it is possible to obtain valid characterizations even in the presence of ambient noise as shown in figure 9.

It is also possible to use impulse type signals for this measurement. Since the time record collection time is only a few milliseconds, this can minimize the echo problems.

With a slightly different hook-up the electrical impedance of a loudspeaker can even be measured.



Figure 9:
Loud Speaker Response

• Structural analysis

A broad range of mechanical structures can be adequately described as linear systems and can be characterized by their frequency

SIGNAL ANALYZERS

Dual-Channel, Dynamic Signal Analyzers 0.02 Hz to 25.5 kHz

Model 3582A (Cont.)

domain transfer functions. These transfer functions relate applied forces and the resulting motion. This example illustrates the driving point inertance (acceleration/force) transfer function of a small beam.

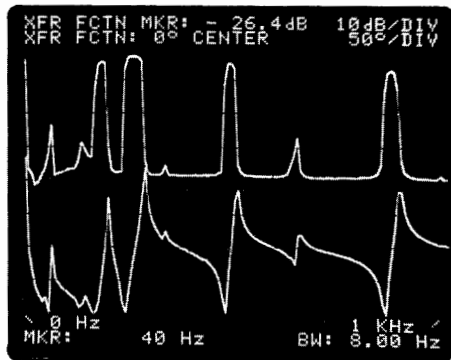

Figure 10:
Driving Point Inertance

• Rotating machinery signatures

Every rotating machine exhibits a unique characteristic vibration pattern determined not only by the basic design and construction of the machine, but also by environmental factors and wear. With the appropriate transducers the Model 3582A can measure and analyze these vibration patterns or "signatures."

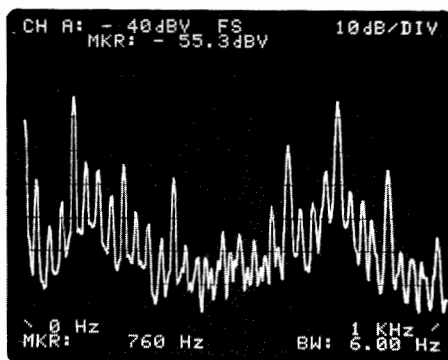

Figure 11:
Rotating Machine Signature

3582A Specifications

Frequency

Range: 0.02 Hz to 25.5 kHz with the low frequency limit the result of DC response.

Spans: 1 Hz to 25 kHz in a 1-2.5-5-10 sequence. The 1 Hz and 2.5 Hz spans are usable only in the 0-start mode.

Accuracy: $\pm 0.003\%$ of display center frequency.

Resolution: 0.4% of the frequency span for single channel or 0.8% of the frequency span for dual channels.

Filter passband shape:

	Flat Top	Hanning	Uniform
3 dB Bandwidth (single channel)	$(1.4 \pm 0.1\%)$ of span	$(0.58 \pm 0.05\%)$ of span	$(0.35 \pm 0.02\%)$ of span
Shape Factor	2.6 ± 0.1	9.1 ± 0.2	716 ± 20

Amplitude

Display modes:

Log: 10 dB/division or 2 dB/division

Linear: Constant voltage/division

Measurement range:

Log: +30 dBV to -120 dBV noise floor

Linear: +30 V to 1 μ V noise floor

Dynamic range: 70 dB

DC response: Adjustable to >40 dB below maximum input level

Accuracy:

Accuracy at the Passband Center ± 0.5 dB

Flat top filter: +0, -0.1 dB

Hanning filter: +0, -1.5 dB

Uniform filter: +0, -4.0 dB

Note: Overall accuracy is the sum of the accuracy at the passband center plus the selected filter accuracy.

Resolution:

Log: 0.1 dB

Linear: 3 digits

Phase

Display range: +200 degrees to -200 degrees

Accuracy: ± 10 degrees

Resolution: 1 degree

Transfer Function

Measurement range:

Log: +160 dB full scale to -80 dB full scale

Linear: 4×10^8 full scale to 4×10^{-8} full scale

Phase display range: +200 degrees to -200 degrees

Accuracy:

Amplitude: ± 0.8 dB

Phase: ± 5 degrees

Accuracy: Option 001

Amplitude ϕ	0.4 dB	0.8 dB
	$\pm 2^\circ$	$\pm 5^\circ$

.02 Hz 5 kHz 25.5 kHz

Coherence

Measurement range: 0.0 bottom display line to 1.0 top display line

Resolution: 0.01

Input

Impedance: $10^6 \Omega \pm 5\%$ shunted by <60 pF from input high to low (for less than 75% relative humidity)

Isolation: Input low may be floated up to 30V

Coupling: Switch selection of AC or DC coupling. The low frequency 3 dB roll off is <1 Hz.

Common mode rejection:

50 Hz: >60 dB

60 Hz: >58 dB

Crosstalk: <-140 dB between channels with 1 k Ω source impedance driving one channel and the other terminated in 1 k Ω .

Output

X-Y recorder:

Level: 0V to 5.25 V $\pm 5\%$

Impedance: 1 k Ω

Pen lift: contact closure during sweep

Noise source:

Type: Periodic pseudorandom noise or random noise signal with switch selection. Both are band limited and band translated to match the analysis.

Level: From <10 mV to >500 mV RMS into $>50 \Omega$

Impedance: $<2 \Omega$

General

Environmental:

Temperature: 0°C to 55°C operating; -40°C to +75°C storage

Humidity: $<95\%$ R.H. 0°C to 40°C

Power requirements: 100, 120, 220, or 240 volts (+5%, -10%); 48-66 Hz; less than 150 VA

Dimensions

Size: 425.5 W x 552.5 D x 188 mmH (16.75" x 21.75" x 7.4")

Weight: 24.5 kg (54 lbs.); shipping weight: 29 kg (63 lbs.)

Options

Opt 001: High Accuracy Transfer Function Measurement Option

Price

add \$500

3582A Spectrum Analyzer

\$10,700

SIGNAL ANALYZERS

Automatic Spectrum Analyzers From 10 Hz to 13 MHz

Models 3044A/3045A

565



3044A

- High accuracy and resolution digital amplitude measurements
- Synthesizer frequency accuracy and stability
- Wide amplitude range of 150 dB
- Narrow band analysis
- Full digital control via HP-IB

3045A

- Full automation and low cost
- Speed and precision in measurements
- Data analysis and presentation of results
- Simplicity and flexibility in operation
- HP-IB systems interfacing flexibility
- 9825T Desktop Computer

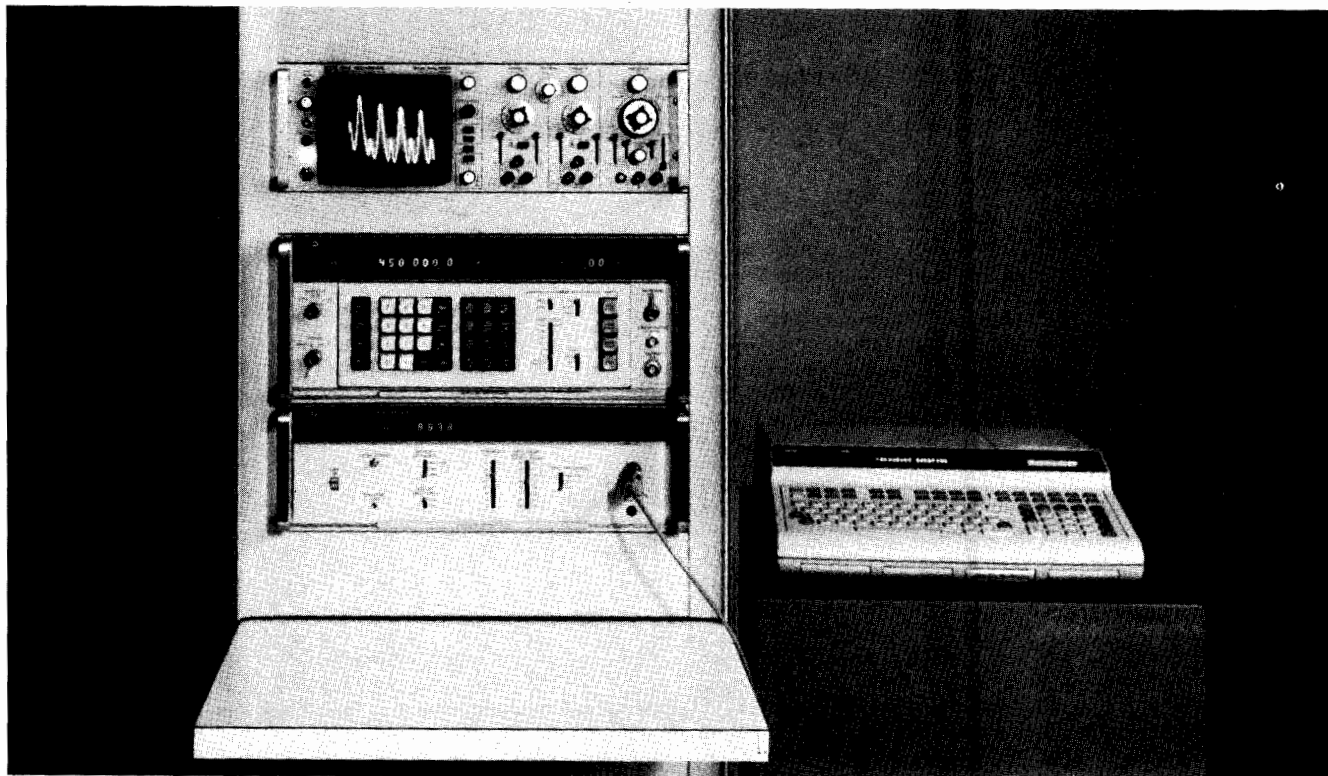

3045 System with Option M40 (HP Model 1201B Oscilloscope)



Description

3044A Spectrum Analyzer

Meeting the demand for precise frequency and amplitude measurements in the 10 Hz to 13 MHz region, the 3044A is a spectrum analyzer with tracking generator. This system uses a synthesizer with leveled output and sweep capability to generate the local oscillator signal for the analyzer and the tracking generator output. This allows fast, extremely accurate "tuning" with the use of frequency up-down keys or keyboard entry of center frequency. The input impedance is front-panel switch selectable to 50 Ω , 75 Ω , and 1 M Ω . The units of the digital display are also front-panel selectable to dBm, dBV and dB relative to a user-entered offset. Digital display of amplitude and frequency gives an unambiguous, high-resolution readout commensurate with the wide dynamic range and high accuracy of this analyzer.

3045A Automatic Spectrum Analyzer

While the 3044A is an excellent stand-alone spectrum analyzer, the capabilities are greatly improved with the addition of the 9825T Desktop Computer, which forms the 3045A system.

The 9825T Desktop Computer allows program and data storage on its fast tape cassette. The tape cassette, short calculation times and

buffered input/output speed allow repeated, automated tests which can greatly reduce production and quality-assurance test times. Also the scope of possible measurements greatly increase with the 3045A System. Logarithmic sweeps and limit tests are only two examples. The calculator also allows data manipulation and presentation in units familiar to the system operator in graphic or tabular form.

Because the user may not be familiar with HPL (the language of the 9825T) or even with programming, a compiler is furnished with the 3045A System. The compiler allows the calculator to converse in terms understood by the test engineer, like start and stop frequencies, plot results, and compare with limits. It also accepts and outputs in units of Hz, kHz, MHz, dBm and dBV. The compiler enables the execution of sophisticated tests, like intermodulation distortion measurements, with only a few minutes of initial "programming" time. It can also record the test parameters, which can then be used repeatedly, as in a production environment. The compiler's versatility and ease of use make the full power of the 3045A Spectrum Analyzer readily available to the user.

The 3045A Automatic Spectrum Analyzer system is fully integrated, tested, verified and specified as a system. It is supplied with complete software and documentation.

SIGNAL ANALYZERS

Automatic Spectrum Analysis From 10 Hz to 13 MHz (Cont.)

Applications

Sideband Analysis

This is a more traditional spectrum analysis measurement using HP's 3044A and 1201B Oscilloscope. Figure 2 is a picture of the spectrum. The carrier frequency was required to be at 10.7 MHz. Therefore, the synthesizer was set up with 10.7 MHz center frequency and a ± 500 Hz sweep about the center frequency. From the display, it is apparent that the carrier frequency is approximately where it should be. It is possible to move the center frequency in 0.1 Hz steps with the step keys and look for the peak response to more accurately identify the carrier frequency.

Using the 3 Hz resolution bandwidth, 60 Hz spurious responses are revealed. Noise products also appear very close to the carrier. Here the wide dynamic range of the system exposes the responses that are more than 70 dB below the carrier.

Distortion Measurements

The spectrum analyzer system can be very powerful for characterizing the complete response of amplifiers. Gain, noise, spurious distortion and frequency response can all be done with the one setup. This example of distortion measurement is one part of the total characterization that can be done.

Distortion of audio frequencies as they pass through amplifiers is measured by several methods. Total harmonic distortion is found by measuring the harmonic output assuming a pure sinewave input. Here again the 3045A offers benefits through calculation power. After the user enters the fundamental frequency, the Desktop Computer makes measurements at the appropriate frequencies and calculates the percentage distortion. Figure 3 shows the type of user-oriented printout that is possible using the 9825T Desktop Computer and an HP printer.

Intermodulation distortion can similarly be measured as part of the same system provided the sources are available.

Modulation Measurements

Both AM and FM modulation show up very well in the frequency domain. Figure 4 shows a typical wideband FM signal. The Desktop Computer is used to program the instruments for measurements at the carrier and sideband frequencies. From the data, the modulation index was calculated to be 1.53 with a Desktop Computer Bessel algorithm. This is a good example of using 3045A to make measurements that are not easy with a manual spectrum analyzer.

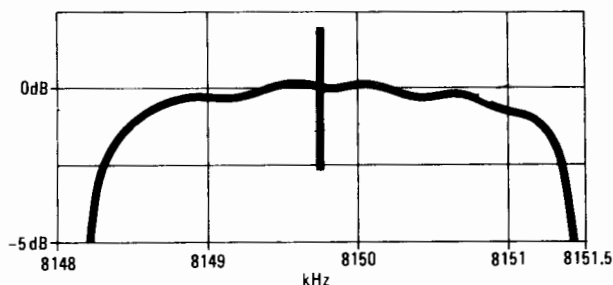

Figure 1. This bandpass filter was characterized using a 3044A system and an x-y recorder. By expanding the Y-axis to cover only 5 dB, the ripple and 3 dB points are very easy to identify.

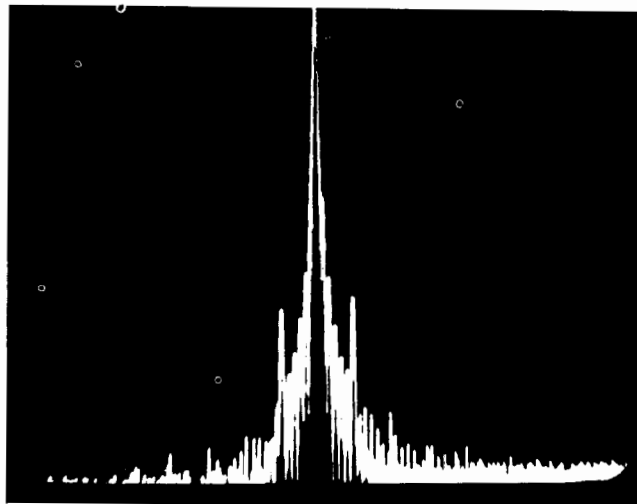

Figure 2. A 3044A was used to analyze close in spurious and noise of 10.7 MHz carrier. The sweep covers 1 kHz around the carrier.

TOTAL HARMONIC DISTORTION TEST			
FUNDAMENTAL FREQUENCY		ABSOLUTE LEVEL	
	1231.0	0.7 DBV	
HARMONIC FREQUENCY		RELATIVE LEVEL	
2	2462.0	-44.20	DB
3	3693.0	-49.20	DB
4	4924.0	-60.70	DB
5	6155.0	-60.40	DB
6	7386.0	-77.50	DB
TOTAL HARMONIC DISTORTION EQUALS -42.05 DB			
OR 0.72 PERCENT			

Figure 3. Using a 3045A system, an amplifier can be completely characterized for total harmonic distortion as well as intermodulation distortion, noise, spurious, frequency response and gain.

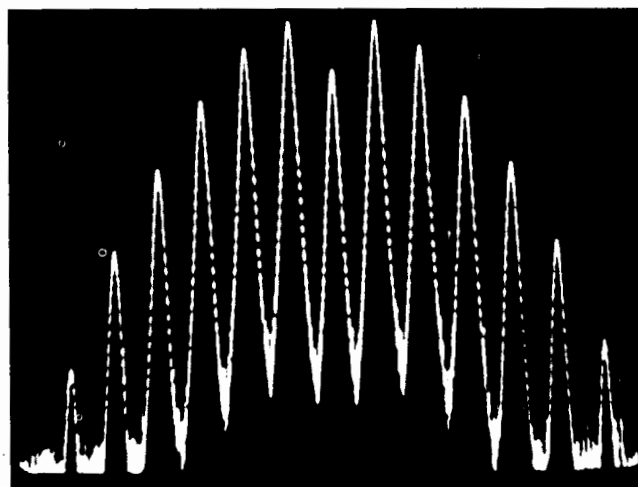

Figure 4. Wideband FM modulation with a 5.3 MHz carrier.



Accurate and Repeatable Results

Whether the spectrum analysis environment is the R & D lab, production test or Q.A., the prime requirement is almost always for test results that are both accurate and repeatable, and easily and quickly acquired. The 3044A/3045A systems meet all of these testing requirements. The analyzer with its synthesized source offers drift-free performance with high accuracy. Because the system is fully programmable, a controller such as a Desktop Computer can set analyzer RF and IF gains, bandwidths, sweepwidths, etc.—operations that would be time consuming and error-prone with a manual system. Results are thus very repeatable and a highly trained operator is not required.

High Resolution and Wide Dynamic Range

The spectrum analyzer systems offer 0.1 Hz tuning resolution and 0.01 dB amplitude resolution. The high resolution display, combined with the analyzer's wide 80 dB dynamic range, allows accurate measurement of signal peaks and spurious responses in one sweep. The analyzer also features a large amplitude range of 150 dB (+10 dBV to -140 dBV), making it suitable for a wide range of applications.

Presentation of Results

Using the 9825T Desktop Computer, the 3045A system offers a variety of formats for data presentation—from a simple pass/fail indication on the computer's alphanumeric display to more complete presentations on a wide range of HP-IB printers and plotters. An example print out is shown below.

```

Amplifier Test          S/N 12345

Gain Test
  1 KHz ref.           0.12 dBm output    PASSED
.....

Freq. Response Test
  3 dB Corner Freq.    1.1 MHz          PASSED
.....

Linearity Test
  (10dBm ref.)         1.13 dB compression    FAILED

UNIT FAILED---Check adjustment of R22
.....

```

Test results printed on the HP 9871A

3044A/3045A Specifications

Frequency Specifications

Frequency range: 10 Hz to 13 MHz.

Scan width: any desired scan is possible in 10, 100 or 1000 steps of frequency increments as small as 0.1 Hz and with 0.1 Hz resolution. The 3045A is additionally capable of taking any number of steps with direct calculator control of the sweep.

Resolution

Bandwidth: 3 Hz to 10 kHz in a 1, 3, 10 sequence.

Bandwidth selectivity: 60 dB/3 dB bandwidth ratios $\leq 11:1$.

Stability

Long term: $\pm 1 \times 10^{-8}$ day.

$\pm 1 \times 10^{-7}$ month.

Phase noise: <50 dB below CW signal in a 30 kHz band around signal.

Amplitude Specifications

Absolute amplitude calibration range: -130 dBm to +20 dBm (50 or 75 Ω). -140 dBV to +10 dBV.

Digital amplitude readout: ± 199.99 dB with 0.01 dB resolution.

Dynamic range

Average noise level: -127 dBV in 1 kHz resolution bandwidth.

Smoothing (video filter): provides smoothing with a bandwidth of $\frac{1}{50}$ th the resolution bandwidth on all but the 3 Hz and 10 Hz bandwidths.

Spurious responses: >70 dB below input range setting.

Distortion responses: >80 dB below input signal at input range setting level.

Power-line related responses: 70 dB below input range on +10 dBV through -40 dBV ranges; 60 dB on -50 dBV; 50 dB on -60 dBV ranges.

Amplitude Accuracy

Frequency response: ± 0.25 dB (250 kHz reference).

Input range: ± 0.07 dB/step, ± 0.2 dB total accumulation.

Log linearity:

0 to -30 dB ± 0.1 dB.

-30 to -60 dB ± 0.25 dB.

-60 to -80 dB ± 0.75 dB.

Stability: (8 hr., 25°C ± 1 °C, after 1 hr. warmup)

10 kHz, 3 kHz, 100 Hz, 30 Hz, 10 Hz, BW's

0 dB	-30 dB	-60 dB
± 0.05 dB		± 0.08 dB

temp. coefficient

± 0.02 dB/°C

1 kHz, 300 Hz, 3 Hz BW's

0 dB	-30 dB	-60 dB
± 0.08 dB		± 0.15 dB

± 0.04 dB/°C

Tracking Generator (3330B output)

Frequency range: 0.1 to 13 000 999.9 Hz.

Frequency resolution: 0.1 Hz (9 digits).

Amplitude range: +13.44 to -86.55 dBm (50 Ω).

+11.68 to -88.31 dBm (75 Ω option).

Amplitude Accuracy

Leveled frequency response (10 kHz reference)*

10 Hz	13 MHz	
± 0.05 dB		+13.44 dBm
± 0.1 dB		-16.55 dBm
± 0.2 dB		-36.55 dBm
± 0.4 dB		-66.55 dBm
		-86.55 dBm

*Add 0.5 dB for leveling switch in off position.

Attenuator (10 kHz reference, 25°C ± 5 °C): ± 0.02 dB/10 dB step of attenuation from maximum output.

Absolute accuracy: ± 0.05 dB at 10 kHz and +13.44 dBm (25°C ± 5 °C).

Amplitude stability (24 hr., 25°C ± 1 °C): ± 0.01 dB.

General

Input impedance: 50 Ω , 75 Ω >30 dB return loss.

1 M Ω $\pm 5\%$ shunted by 30 pF.

Maximum input level: +20 dBm.

Programmability: all controls, except power switches, are programmable using the HP-IB format.

3044A/3045A Options

The basic 3044A and 3045A system options are listed below. For more information refer to the 3044A/3045A data sheet.

3044A Options

110: Standard 3571A

Price

add \$8750

120: Standard 50 Ω 3330B w/Isol. HP-IB

add \$8900

121: Standard 75 Ω 3330B w/Isol. HP-IB

add \$8900

122: 5 V Output

add \$310

3045A Options

200: 50 Ω System

N/C

201: 75 Ω System

N/C

Ordering Information*

3045A Automatic Spectrum Analyzer consisting of: \$29,750

3330B Synthesizer; 3571A Spectrum Analyzer; 9825T

Desktop Computer, 64 k bytes memory; ROMs,

Interface, documentation; 56" Rack.

*HP-IB cable not supplied. See page 30.

SIGNAL ANALYZERS

Digital Signal Analyzers

Models 5420A and 5423A

- Dual-Channel Transfer Function
- Band Selectable Analysis
- Fully Calibrated Annotated Display

- Powerful Post-Measurement Processing
- Digital Data Storage
- Random Noise Generator



5423A



The 5420A Digital Signal Analyzer and 5423A Structural Dynamics Analyzer are high performance dual-channel instruments capable of a number of both time domain and frequency domain measurements over a 25 kHz range. In addition to broad measurement capability, the 5423A Structural Dynamics Analyzer provides complete facilities for analyzing the vibration characteristics of mechanical devices and displaying the results in the form of an animated mode shape. Both instruments are particularly adapted to solving problems associated with structural vibration and noise, rotating machinery, electro-mechanical control systems, acoustics and a host of similar applications which call for advanced low-frequency analysis.

Among the important standard features are a fully annotated and calibrated dual-trace display, permanent digital storage for measurement results, band selectable analysis, extensive data processing, advanced triggering capability, external sampling capability, calibration in engineering units and a built-in random noise generator. Capable of both stimulus-response and response only analysis, their measurement repertoire includes:

- Transfer Function
- Coherence Function
- Impulse Response
- Auto Spectrum
- Cross Spectrum
- Linear Spectrum
- Time Record
- Amplitude Histogram
- Auto Correlation
- Cross Correlation

Important capabilities such as independent pre and post trigger delay on each input channel, overlap processing, and external sampling insure that each instrument's measurement power can be effectively applied to a wide range of problems.

A built-in "waveform calculator" is useful for processing measured or synthesized data and greatly extends the basic capabilities. Examples of useful computed functions include:

- Data Comparisons
- Resonant Frequency
- % Critical Damping
- Open Loop Gain
- Calibration in %
- Mechanical Impedance
- Total Harmonic Distortion
- Coherent Output Power
- Signal-to-Noise Ratio
- Transmissibility
- Function Synthesis
- Power

Operation

Operation of a digital signal analyzer has never been easier. A novel "menu" concept replaces the rotary and toggle switches commonly used to control an instrument's operation. The entire current set-up state, including measurement type, bandwidth, input ranges, etc., is displayed on the CRT at the push of a key. Changes to the set-up are made by selection from displayed lists (menus) or by direct numerical input from the control keyboard.

Once set-up, measurements are easily executed and may be paused or continued at will. Results are always fully calibrated and annotated. A self-test feature verifies proper operation.

Data Display

Both the 5420A and the 5423A feature a fully annotated and calibrated, dual trace, three-format display which provides for ease of data interpretation. Each display trace is totally independent of the other in terms of the data which the user selects for display, the horizontal and vertical ranges over which it is displayed, and the coordinate system chosen. The user may select from up to 13 available coordinate systems, including complex plots such as Nyquist, at the push of a key. Display traces may be viewed one at a time in full format or simultaneously in either an upper/lower or overlaid format.

Dual X and Y axis cursors provide numerical data readout, in either absolute or relative terms, on both axes simultaneously in full format. Any area of the display may be graphically expanded for optimum viewing. Cursors may be either swept or set explicitly, via numerical entry, to desired locations. Harmonic cursors are provided. The X axis cursors may also be used to set the frequency range over which the instrument will operate, thereby concentrating its resolution into the bandwidth of interest.

The display section also contains a digital recorder which provides permanent storage of measurement results on small removable tape cartridges and eliminates the need to repeat time consuming and expensive testing. Stored measurements may be easily recalled for display, plotting, or further processing.

SETUP STATE

MEASUREMENT :	TRANSFER FUNCTION			
AVERAGE :	25	.	STABLE	
SIGNAL :	RANDOM			
TRIGGER :	FREE RUN	.	CHNL 1	
CENT FREQ :	2.00000 KHZ			
BANDWIDTH :	800.000 HZ			
TIME LENGTH :	320.000 μS			
ΔF :	3.12500 HZ	ΔT :	625.000 μS	
ADC CHNL	RANGE	AC/DC	DELAY	CAL (C1/C2)
1	5 V	AC	0.0 S	33.3333
* 2	10 V	DC	10.0000 S	20.0000

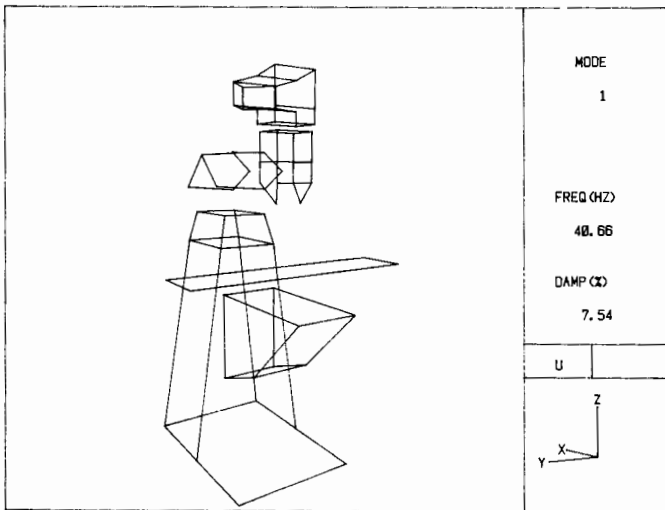
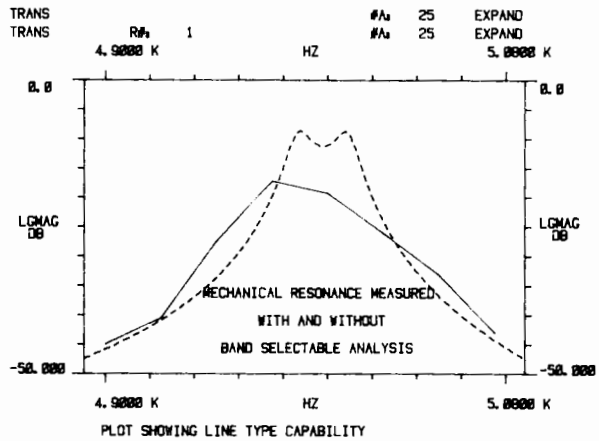
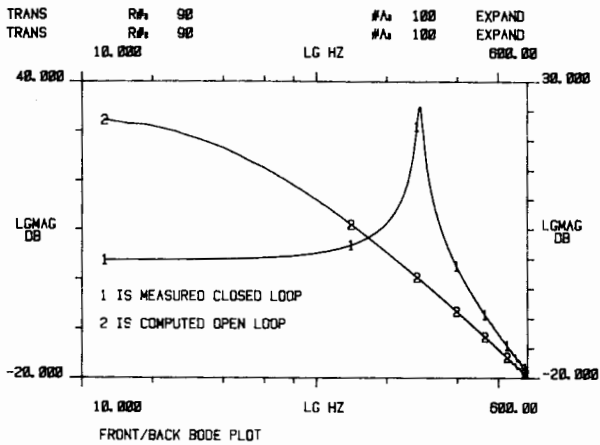
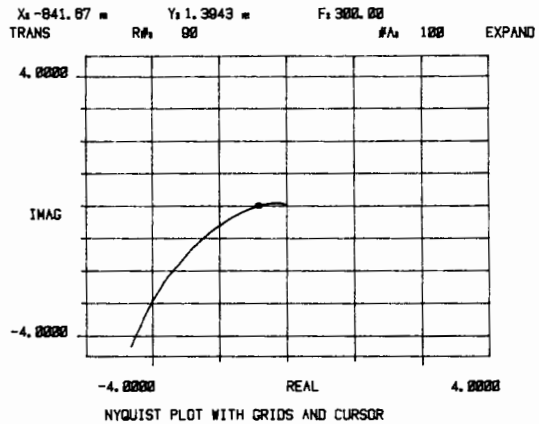
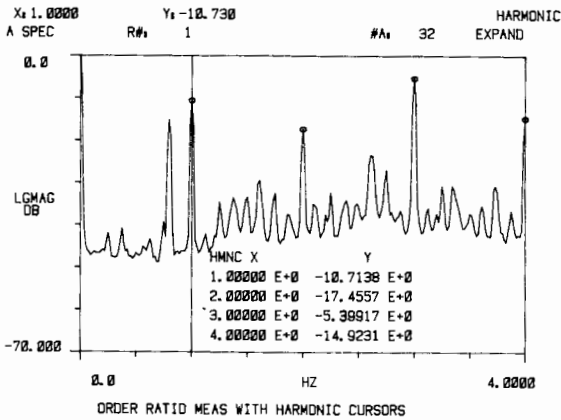

MODE SHAPE

MODE NO. :	1	M. MASS:	10.139 μ	LB-SEC ² /IN
FREQ (HZ) :	40.660	M. DAMP:	391.530 μ	LB-SEC/IN
DAMP (%) :	7.537	M. STIF:	665.487 m	LB/IN

DOF#	PT	DIR	AMPLITUDE
1	1	X	-15.4968 μ
2	1	Y	30.9400 μ
3	1	Z	-563.770 μ
4	2	X	10.2221 μ
5	2	Y	26.5220 μ
6	2	Z	-640.359 μ
7	3	X	19.2426 μ
8	3	Y	-9.0004 μ
9	3	Z	-479.791 μ
10	4	X	9.1779 μ

TOTAL DEGREES OF FREEDOM: 348

Dynamic Analysis

The 5423A provides, for the first time in a transportable, easy to use, low cost instrument, complete dynamic analysis capability. Frequency response measurements are made at points of interest on the test structure. The 5423A then analyzes the raw data to determine the frequency and damping associated with the structure's natural modes of vibration. In addition, the deflection pattern or mode shape of the structure is calculated for each mode of vibration. Results are available in tabular form or as an animated display with perspective to ease interpretation.

Mode shape display features include the ability to view the structure from any desired direction and distance. Amplitude and speed of animation are easily controlled and the structure can be made to rotate about any desired axis. A split-screen format facilitates compari-

son of different modes of vibration and may also be used to observe the structure in three dimensions with stereo viewers.

HP-IB*

Both the 5420A and 5423A include an HP-IB interface to provide for instrument control and data transfer to and from external computing controllers. In addition, both instruments are directly compatible with the HP 9872, 7245, and 7221/17601 Digital Plotters. A separate computing controller, with its attendant cost and programming requirements is not needed. The user merely presses the plot or print key and the instrument will reproduce the desired information in hard copy form on the plotter.

Ordering Information

5420A Digital Signal Analyzer

5423A Structural Dynamics Analyzer

*HP-IB cables not supplied, see page 30 for description and prices

Price

\$30,500

\$41,000



SIGNAL ANALYZERS

Digital Fourier Analysis System

Model 5451C

- NEW Increased Mass Storage Capability
- Keyboard-Controlled Data Acquisition and Analysis
- >75 dB Dynamic Range

- Multi-Channel Operation DC to 50 kHz (100 kHz Optional)
- Dedicated Application Packages

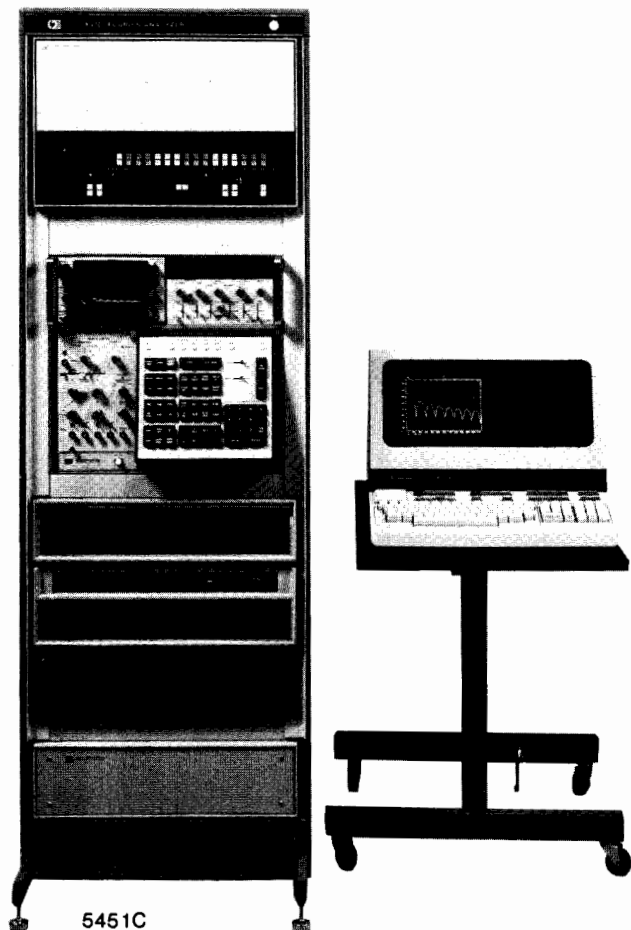

Description

The 5451C Fourier Analysis System provides digital frequency domain analysis of complex time signals in the frequency range of DC to 50kHz (100kHz optional). The system is completely integrated and consists of a mini-computer for digital processing, a keyboard for operator control of the system, a dual channel analog-to-digital converter (4 channels optional), a display control unit and CRT, a graphics terminal, and an operating software package. It is a fully calibrated, multi-purpose digital system for data acquisition, data storage, and data analysis. The primary analysis functions which are controlled from the system's keyboard include: forward and inverse Fourier transform, auto and cross power spectrum, transfer and coherence function and time or frequency domain averaging.

The ability to measure these functions quickly and accurately and with large dynamic range makes the Fourier Analysis System a powerful tool for stimulus-response measurements, system identification, vibration control, modal analysis, signature analysis, communications, and more.

Band Selectable Fourier Analysis

5451C Band Selectable Fourier Analysis (BSFA) allows you to perform digital spectrum analysis over a frequency bandwidth whose center frequency and bandwidth are independently selectable. This frees you from the DC to F_{max} restriction of conventional baseband digital signal analysis. With BSFA, the frequency resolution of a

measurement can be increased by a factor of over 400:1 without increasing the amount of computer data space required. Also, frequencies outside the band of interest are attenuated by more than 90dB, which means that the full dynamic range of the analyzer can be applied to the band of interest without interference from outside frequencies.

Features include: all digital operation, on-line or off-line analysis, keyboard operation, four-channel analysis for cross measurements, and center frequency range from DC to 100kHz.

Mass Storage

New to the 5451C Fourier Analysis System, the HP7906 Random Access Disc Drive extends the operational capabilities of the system and provides greater permanent storage for data and programs than ever before. In addition, larger ADC Throughput files permit storage of directly digitized time domain data at a real time rate better than 140kHz—ensuring that no important data will be missed. This data can then be analyzed in a variety of ways at your convenience.

5451C Application Packages

Modal Analysis

Hewlett-Packard offers a comprehensive modal analysis system designed to meet the requirements of a wide range of modal testing applications. The Hewlett-Packard Modal System operates on measured transfer function data to determine modal properties. In addition, an animated isometric display of the structure under test is generated to aid in understanding its dynamic characteristics. This system offers significant time savings over traditional swept sine analog techniques and provides random, pseudo-random, transient, or periodic random excitation for transfer function measurements.

Signature Analysis

Noise, vibration, and failure problems in rotating machinery are easily analyzed using Hewlett-Packard's powerful Signature Analysis Package. It combines key rotating machinery measurements into a dedicated user-oriented system that's used for preventive maintenance, production quality control, design analysis, and noise and vibration studies.

Six measurements are pushbutton selectable from the operator's control panel: RPM and TIME Spectral Maps, Power Spectrum Analysis, Composite Power Spectrum, Order Ratio, and Order Tracking. This complete range of measurement and analysis features helps you gain insight into the overall dynamic characteristics of the device, eliminating time-consuming trial-and-error procedures.

Vibration Test Control

This package provides all the features present in Hewlett-Packard's 5427A Vibration Control System (see next page).

Hardware Options

In addition to the above software application packages, the following hardware options are available for increased system versatility:

- Programmable Low Pass Filters to automatically protect your measurements from errors due to aliasing of out-of-band frequencies.
- Pre-Processor for fast, convenient Band Selectable Fourier Analysis on up to 4 channels simultaneously.
- Digital-to-Analog Converter to generate your own test signals directly from digital data created in the 5451C.

5451C Base System Price

from \$74,200

SIGNAL ANALYZERS

Digital Vibration Test Control System

Model 5427A and 5451C Option 350



- Random Test Flexibility for Use with MIL, IEC, and other Standards
- Automatic Out-of-Tolerance Detection Protects Device-Under Test

- Economical Expansion for Sine and Transient Control
- Ultra-High Random Control Resolution: 512 Lines Standard (1024 Lines Optional on 5427A, Standard on 5451C Option 350)

Description

Closed-loop control of environmental and/or developmental vibration test stimuli for random, transient, and sine testing is available in either of two product concepts: Option 350 to the 5451C Fourier Analysis System or the 5427A, a dedicated system offering essentially the same control performance but with reduced analysis capability.

The basic 5427A Vibration Test Control system consists of: 2-channel (expandable to 4) analog-to-digital converter for processing feedback information; 21MX-E series, microcoded digital processor; 1335A Persistence CRT display; 2648A Graphics Terminal; push-button control unit; 9885M Flexible Disc storage unit; cabinet and programs for random control.

The 5427A is the ideal vibration control system for production vibration testing where random, transient and sine testing are required and offers a selectable set of analysis routines especially designed for easy operation by laboratory personnel. 5451C Option 350 would be a natural addition for the developmental or research vibration laboratory where a full-capability Fourier Analyzer is required. The following vibration test control capabilities apply to both Option 350 on the 5451C and the 5427A.

System Operation

Random, sine and transient control follow the same logical operational phases. First, the appropriate disc is loaded and the test program or setup (envelope, alarm and abort limits, test time, calibrations, etc.) is loaded from disc storage in response to search codes or names. If a new program or modifications are desired, a friendly question-and-answer sequence is used. Once a new setup has been generated or changes made, it can be assigned a new name and stored for later use.

After a satisfactory setup is obtained, the operate phase allows control of the actual test via pushbuttons on the central control panel. Removable snap-on overlay panels clearly label buttons for the type of test desired. Choices of on-line displays and a 'save' button allow saving of data for later plotting, including auxiliary PSD measurements during random control.

After the test, results and all saved data are available for review or documentation. The graphics terminal or an optional HP-IB compatible digital plotter provide fully labeled, report-quality plots of test results.

Specification Summary (5427A and 5451C Option 350)

Random Control

Resolution: 64, 128, 256, or 512 lines (1024 lines optional on 5427A, standard on 5451C Option 350)

Bandwidth: Δf to 5000Hz

Loop time: <0.9 sec for 256 lines, 2500Hz bandwidth, one control channel and full display

Dynamic range: >65dB

Accuracy:

rms PSD accuracy: $\pm 2\%$

Control PSD accuracy: ± 1.0 dB (90% confidence level) Higher accuracies are typically achievable with increased control spectrum averaging.

Sine Control

Frequency range: 0.1 to 5000Hz. Upper and Lower sweep frequency limits and starting frequency may be specified anywhere in the frequency range (Resolution: 0.1Hz).



5427A

Sweep rate: 0.001 to 100 octaves/minute log, 1 to 100,000Hz/minute linear, operator selectable.

Harmonic components: >60dB below full level fundamental output

Sweep time accuracy: $\pm 2.5\%$ or ± 52 msec, whichever is greater

Amplitude accuracy: the greater of ± 2.5 mV or $\pm 1\%$ of specified reference value.

Output dynamic range: 72dB

Transient Control

Classical reference waveforms: Half-sine, terminal peak sawtooth, triangle or rectangle

Polarity: positive or negative

Duration range: 0.5 to 100msec

Duration accuracy: $\pm 5\%$ for half-sine and terminal peak sawtooth at pulse baseline crossover points

Shock response spectrum synthesis: Time domain waveforms are synthesized from a user-specified shock response spectrum (SRS) off-line in the setup mode

Resolution: 1/N octave, N is any integer from 1 to 9

Frequency range: 2 decades nominal, 2.6 decades maximum

Maximum frequency: 1/Nth octave below 10,240Hz

Ordering Information

5427A Vibration Test Control System

5451C Option 350 Vibration Test Software for Fourier Analysis System

Price

\$50,000

\$14,500

SIGNAL ANALYZERS

Frequency Stability Analyzer

Sample of Model 5390A

- Phase noise measurements close to carrier
- Offsets from 0.01 Hz to 10 kHz
- Sensitivity as high as -140 dBc at 1 Hz offset
- Measures sources to 18 GHz
- Automatic Operation

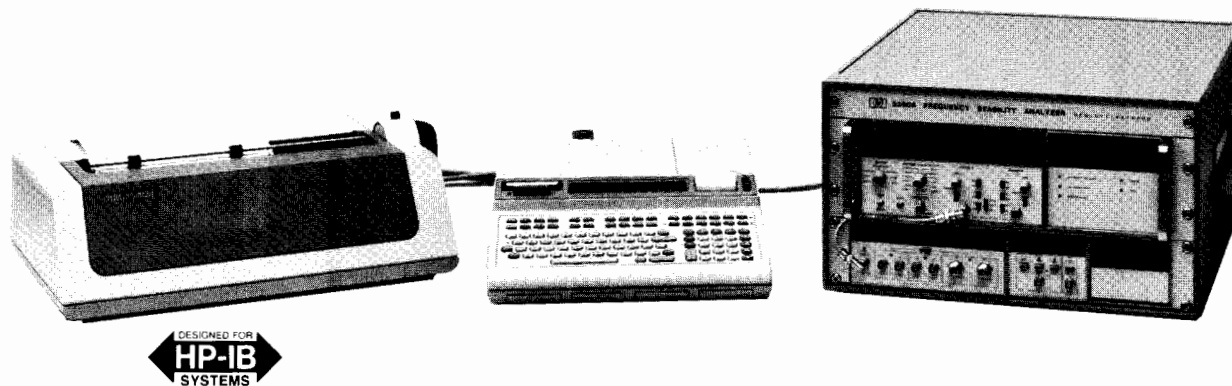

5390A Frequency Stability Analyzer

General

The 5390A Frequency Stability Analyzer will characterize oscillator stability in either the time domain or the frequency domain. For time domain characterization, the 5390A measures fractional frequency deviation which represents the RMS deviation of the signal from the nominal carrier frequency measured over a given time interval. For characterization in the frequency domain, the 5390A presents results in terms of the spectral density of phase fluctuations. The 5390A specializes in high resolution phase noise measurements close to the carrier where other techniques are difficult to use or are unable to make the measurements at all.

The system can accommodate a wide frequency range of input signals from 500 kHz to 18 GHz. Provision is also made for external mixers for broader frequency coverage or direct input in the range of DC-100 kHz. With this amount of flexibility, almost any oscillator can be measured with the 5390A. All the signal processing capabilities needed to make measurements are built into the system, including down-conversion, low-noise amplification, and bandwidth control.

The 5390A is a complete hardware and software measurement system, fully assembled and tested at the factory. Making measurements only requires connecting the test and reference oscillators and specifying a few measurement parameters. Thereafter, the system runs unattended to the completion of the specified group of measurements. Access to the interactive application programs is provided through specially defined keys on the computing controller's keyboard.

Measurement Technique

The basic system configuration uses a heterodyne down-conversion technique to produce a measurable signal. Two oscillators, the test oscillator at a carrier frequency ν_0 and a reference oscillator at a frequency $\nu_0 \pm \nu_b$, are connected to a double balanced mixer through one of the sets of inputs on the 10830A Mixer/IF Amplifier. (Usually two identical oscillators, one slightly offset, are used. In this case, the noise measured is twice the contribution of either oscillator. The 5390A's software can compensate for this factor of two to produce the correct result). The resultant difference frequency (or "beat" frequency), ν_b , is filtered and amplified by a low noise limiting amplifier and applied to the input of the 5345A Electronic Counter. The 5345A makes frequency measurements of the beat frequency under the control of the 5358A Measurement/Storage Plug-in at measurement intervals also determined by the 5358A. The measurement results are stored locally in the 5358A facilitating the taking of a large number of measurements very rapidly and reducing "dead time" between measurements to less than 17 μ s.

Fractional Frequency Deviation Measurements

The 5390A system measures fractional frequency deviation over an exceptionally wide range of averaging times (τ values). τ values as small as 10 μ s and as large as 999×10^3 s can be accommodated by the system. The measurement bandwidth is another parameter critical to the validity of fractional frequency measurements. The 5390A provides the choice of several bandwidths: 100 kHz, 25 kHz, 6.3 kHz, 1.6 kHz, 400 Hz, 100 Hz and 25 Hz. There is also provision for an external filter.

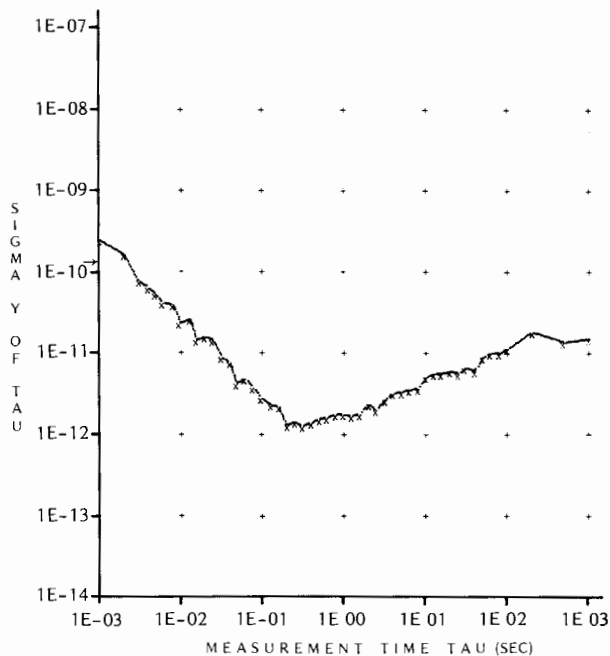

Sample $\sigma_f(\tau)$ vs τ plot generated by 5390A.

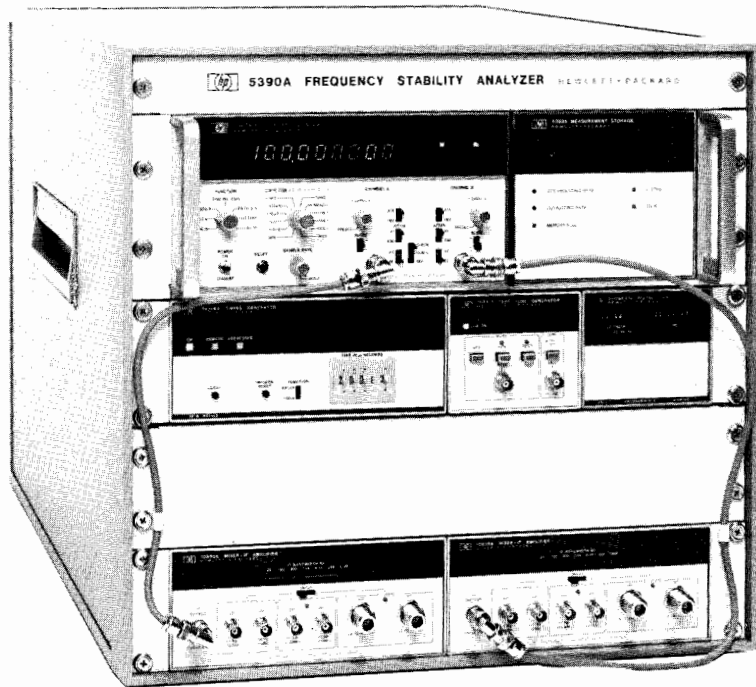

5390 opt 010 instrument cluster (shown with Digital Clock opt 004)

Phase Spectral Density Measurements

The measurement of close-in phase noise (spectral density of phase fluctuations) at offset frequencies from the carrier below 10 to 100 Hz has traditionally been difficult or impossible. Now, with the 5390A, it is possible to make these measurements rapidly and easily. The measurement technique is based on an N sample variance computed by the 9825B from frequency measurements made by the 5345A. Phase noise spectral density is then determined from the measured N sample variance. The 5358A Measurement Storage Plug-In controls gate time and dead time between frequency measurements. This makes the 5345A look like a digital filter in the frequency domain whose center frequency and bandwidth are determined by gate time, dead time, and number of measurements in the sample.

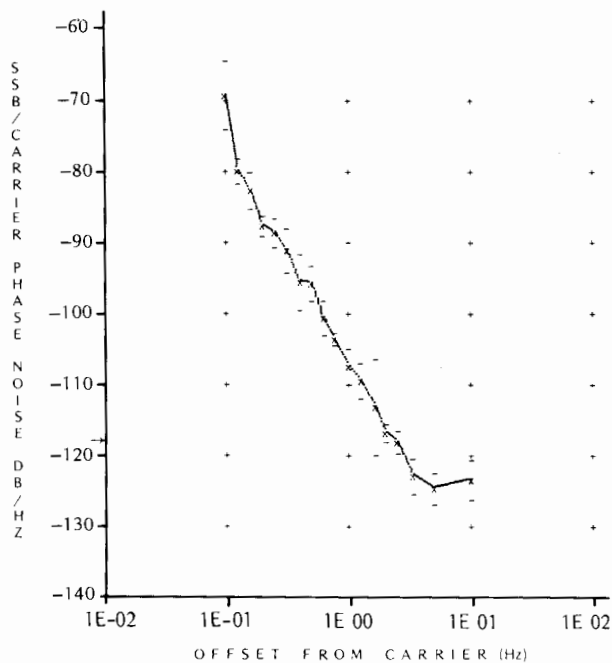

Sample phase noise plot generated by 5390A.

Option 010 Dual Mixer Time Difference

Measurements can be made with the 5390A using either the standard single heterodyne configuration or the dual mixer time difference configuration (Option 010). The primary application of the single heterodyne method is where an offsettable reference oscillator is available, whose noise over the range of interest is equal to or better than the test oscillator. The primary application of the Option 010 configuration is for measuring non-offsettable sources.

In the Dual Mixer Time Difference configuration of the system (Option 010) a second 10830A Mixer-IF Amplifier is added. A third difference oscillator is used in this set-up to produce two measurable signals. The test oscillator at a frequency ν_0 and the reference oscillator at essentially the same frequency are each applied to the 10830A's. The difference oscillator's signal ($\nu_0 + \nu_b$) is split and applied to both 10830A's. The resultant two difference signals (ν_b) are applied to the 5345A's inputs and time interval measurements are made between the two at intervals τ .

Systems Options

Option	Description	Price
001	Expands 5358A memory in 2K increments. Up to 3 Opt. 001's may be added.	\$375 each
004	Adds 59309A Digital Clock and HP-IB cable.	\$1275
010	Adds second 10830A, 59308A, power splitter, system cabinet, and expands 5358A memory to 6K bytes.	\$6450
325	Deletes 9825B and 98034B	\$8700
371	Deletes 9871 Printer/Plotter	\$4725

Ordering Information

5390A Basic System includes:
5345A Option 011 Electronic Counter
5358A Measurement Storage Plug-in
10830A Mixer/IF Amplifier
10831A Test Tone Generator
9825B Computing Controller
 (This includes 32K memory, and all needed ROMs)
98034B HP-IB Interface
9871A Option 001 Printer/Plotter
 System Cabinet
 System Software

5390A Basic System

\$31,675

SIGNAL ANALYZERS

Distortion Measurement Set

Model 339A

- Ultra low distortion measurements
- Built-in low distortion oscillator
- Automatic
- True RMS detection

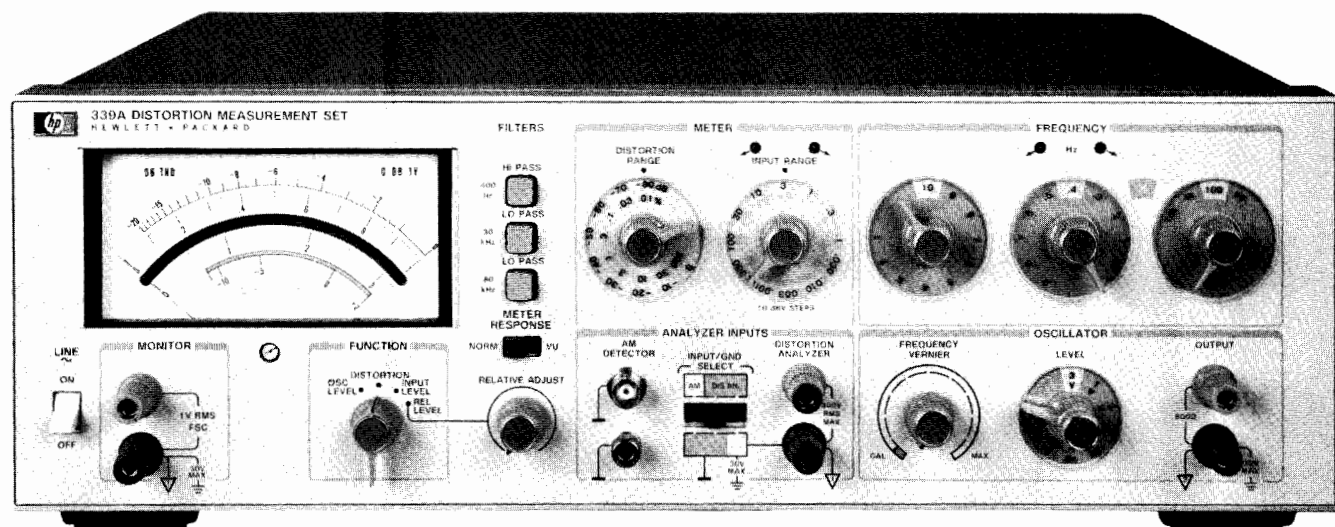

339A

Description

Hewlett-Packard's new Model 339A Distortion Measurement Set is an ultra low distortion measuring system complete with total harmonic distortion (THD) analyzer, true-rms voltmeter, and sinewave oscillator. This small, lightweight bench measurement set allows you to make THD distortion measurements as low as 0.0018% over a 10 Hz to 110 kHz frequency band including harmonics to 330 kHz.

For fast and easy THD measurements the built-in tracking oscillator in HP's 339A saves test time because you tune one instrument instead of two. Frequency and level measurements are easy to do with HP's 339A's voltmeter, which offers you a 1 mV to 300 V measurement range. The Relative Level mode has been included to further simplify frequency response measurements. Just set a 0 dBm reference at any frequency from 10 Hz to 110 kHz. Gain measurements can be read directly from the easy-to-read meter.

Operation Simplicity

Automatic frequency tuning and set-level features allow you to make rapid, error free THD measurements. The 339A's built-in tracking oscillator eliminates the need to find the fundamental frequency and tune the analyzer for a null. Just select your oscillator frequency and the rest is automatic. Automatic set-level saves time by automatically setting 0 dB (100%) reference in the distortion measuring mode. Front panel directional indicators light when the input range setting is improper insuring accurate and repeatable measurements. Automatic set-level also greatly simplifies measurements where distortion as a function of level (SINAD¹, for example) is desired. Without this feature, measurements are very time consuming and tedious.

When an external stimulus is used, analyzer tuning is simplified by directional indicator lights for reaching the fundamental null quickly and easily.

IHF Standards

The ultra low distortion and true rms measuring capabilities of the

339A will be of significant interest to the manufacturers and sales/service companies offering high performance HI-FI equipment. The 339A conforms to portions of a new standard method of measurement for audio amplifiers (IHF-A-202 1978) published by the Institute of High Fidelity, Inc. Particularly noteworthy is the rms measurement of (THD + N) according to sections 1.17 and 2.9.3.1.

SINAD¹ Measurements

Receiver sensitivity and selectivity are two of the most important checks for a transceiver. Since both of these measurements are generally made by the SINAD¹ method, it is very important to use a distortion analyzer that automatically compensates for input variations and provides an accurate indication of noise. Now, with the 339A's auto set level feature and true-rms detection, a more accurate SINAD measurement is possible.

Auto set level eliminates the need for continually checking the 100% set level reference while the receiver input is reduced during the measurement, thus eliminating several tedious operator adjustments with a considerable savings in test time. Also, the true-rms responding 339A more accurately determines the thermal noise and harmonic components in SINAD since it is not subject to the same reading and calibration errors as an average detector.

FCC Requirements

The FCC required features for broadcast testing are included in the 339A. They include an AM detector, 30 kHz low pass filter, and switchable VU meter ballistics.

Other Features

Hum and noise filters, a high level monitor output for further harmonic analysis, and floating input are standard features on the model 339A.

¹SINAD is a sensitivity measurement computed from the ratio of signal plus noise and distortion to noise and distortion.

Specifications

Distortion

Fundamental frequency range: 10 Hz to 110 kHz continuous frequency coverage in 4 decade ranges with 2-digit resolution. Distortion analyzer and oscillator are simultaneously tuned.

Distortion measurement range: 0.01% full scale to 100% full scale (−80 dB to 0 dB) in 9 ranges.

Detection and meter indication: True rms detection for waveforms with crest factor ≤ 3 . Meter reads dB and % THD (Total Harmonic Distortion). Meter response can be changed from NORMAL to VU ballistics with a front panel switch.

Distortion measurement accuracy:

20 Hz to 20 kHz	± 1 dB
10 Hz to 50 kHz	+1, −2 dB
50 kHz to 110 kHz	+1.5, −4 dB

Note: The above specifications apply for harmonics ≤ 330 kHz.

Fundamental rejection (3 V scale or above):

10 Hz to 20 kHz:	> 100 dB
20 kHz to 50 kHz:	> 90 dB
50 kHz to 110 kHz:	> 86 dB

Distortion introduced by instrument (input > 1V rms):

10 Hz to 20 kHz:	< −95 dB (0.0018%) THD
20 kHz to 30 kHz:	< −90 dB (0.0056%) THD
30 kHz to 50 kHz:	< −85 dB (0.01%) THD
50 kHz to 110 kHz:	< −70 dB (0.032%) THD

Residual noise (fundamental frequency settings < 20 kHz, 80 kHz filter 1N, source resistance ≤ 1 K Ω shielded): < −92 dB referenced to 1V.

Input level for distortion measurements: 30 mV to 300 V rms (100 mV range minimum).

Input impedance: 100 k Ω $\pm 1\%$ shunted by < 100 pF input High to Low.

Monitor: Provides scaled presentation of input signal after fundamental is removed for further analysis using oscilloscope or low frequency spectrum analyzer. Output voltage: 1V rms $\pm 5\%$ open circuit for full scale meter indication, proportional to meter deflection. Output resistance: 1k Ω $\pm 5\%$.

Auto set level: No set level adjustment required. Distortion measurements are made directly over 10 dB range selected by input range switch. Two LED annunciators provide a fast visual indication to change input range for valid distortion measurement. Correct range is indicated when both annunciators are extinguished.

Automatic fine tuning: Using internal oscillator: No separate analyzer tuning necessary when using internal oscillator as signal source. Oscillator frequency controls simultaneously tune the analyzer. Using external frequency source: Two LED annunciators provide a quick visual indication for the operator to increase or decrease the frequency. When the analyzer is rough tuned to within one least significant digit of the fundamental frequency, the indicator lights are extinguished and the 339A auto-null circuitry takes over to provide a fast, accurate null without tedious operator tuning.

Input filters (usable on all functions): Low Pass: 30 kHz−3 dB point at 30 kHz, +2.6 kHz, −3 kHz with 60 dB/decade rolloff. Provides band limiting required by FCC for proof-of-performance broadcast testing. 80 kHz−3 dB point at 80 kHz, +7 kHz, −7.9 kHz with 60 dB/decade rolloff. Normally used with fundamental frequencies < 20 kHz to reduce the effect of higher frequency noise present in the measured signal. High Pass: 400 Hz −3 dB point at 400 Hz, +35 Hz, −40 Hz with 60 dB/decade rolloff. Normally used with fundamental frequencies > 1 kHz to reduce the effect of hum components in the input signal.

DC isolation: Input low may be connected to chassis ground or floated to 30 V to reduce the effects of ground loops on the measurement.

Relative Input Level Mode

Provides a ratio measurement relative to an operator selected reference level with readout directly in dBV or dBm (600 Ω). Voltage range, frequency range, accuracy specifications, and monitor are the same as in Voltmeter mode. (Accuracy is relative to 0 dB set level input.)

Oscillator

Frequency range: 10 Hz to 100 kHz in 4 overlapping decade ranges with 2 digit resolution. Frequency vernier provides continuous frequency tuning between 2nd digit switch settings.

Output level: Variable from < 1 mV to > 3 V rms into 600 Ω with 10 dB/step Level control and > 10 dB Vernier adjustment. OSC Level position on function switch allows a quick check of oscillator level without disconnecting leads to device under test. Off position on Oscillator Level control provides fast signal-to-noise measurement capability. Oscillator output terminals remain terminated in 600 Ω .

Frequency accuracy: $\pm 2\%$ of selected frequency (with Frequency Vernier in Cal position).

Level flatness:	20 Hz to 20 kHz:	$\leq \pm 0.1$ dB
	10 Hz to 110 kHz:	$\leq \pm 0.2$ dB

Distortion ($\geq 600\Omega$ Load, $\leq 3V$ Output):

10 Hz to 20 kHz:	< −95 dB (0.0018%) THD
20 kHz to 30 kHz:	< −85 dB (0.0056%) THD
30 kHz to 50 kHz:	< −80 dB (0.01%) THD
50 kHz to 110 kHz:	< −70 dB (0.032%) THD

Output resistance: 600 Ω $\pm 5\%$

Voltmeter

Voltage range: 1 mV rms full scale to 300 V rms full scale (−60 dB to +50 dB full scale, meter calibrated in dBV and dBm into 600 Ω).

Detection and meter indication: True rms detection for waveforms with crest factor ≤ 3 . Meter reads true rms volts, dBm into 600 Ω , and dBV.

Accuracy (% of range setting):

20 Hz to 20 kHz:	$\pm 2\%$
10 Hz to 110 kHz:	$\pm 4\%$

Frequency range: 10 Hz to 110 kHz.

Input impedance: 100 k Ω $\pm 1\%$ shunted by < 100 pF between input High to Low.

Monitor: Provides scaled presentation of input signal for further analysis using oscilloscope or low frequency spectrum analyzer. Output voltage: 1V rms $\pm 5\%$ open circuit for full scale meter indication, proportional to meter deflection. Output resistance: 1 k Ω $\pm 5\%$.

Option 001

Voltage Range: 0.1 mV rms full scale to 300 V rms full scale (−80 dBV to +50 dBV full scale); (.1 mV and .3 mV ranges—external source resistance must be < 10 k Ω .)

Accuracy: 1 mV to 300 V ranges:

20 Hz to 20 kHz	$\pm 2\%$
10 Hz to 110 kHz	

.1 mV and .3 mV ranges:

20 Hz to 20 kHz:	$\pm 2\%$
10 Hz to 30 kHz:	$\pm 4\%$
30 kHz to 80 kHz:	+10/−30%

Noise Floor (600 Ω source impedance):

30 kHz filter	< 6 μ V
80 kHz filter	< 8 μ V

AM Detector

Frequency range: Carrier frequencies: 550 kHz to 1.6 MHz. Modulation frequencies: 20 Hz to 20 kHz.

Distortion introduced by AM Detector (with 30 kHz filter switched IN): Up to 85% Modulation: < −36 dB (1.6%) THD
85% to 95% Modulation: < −30 dB (3%) THD

Input level: Maximum: 60V peak. Modulation signal level: 2V rms minimum; 10V rms maximum.

Monitor (with Modulated RF Carrier Applied to AM Detector Input).

Distortion mode: Provides scaled presentation of demodulated input signal after fundamental is removed.

Voltmeter and relative input mode: Provides scaled presentation of demodulated input signal. Output voltage and output resistance are the same as in Distortion mode.

General

Power: 100/120/220/240 V + 5%, −10% 48 Hz to 66 Hz line operation, 200 mA maximum.

Size: 146 mm H x 426 mm W x 375 mm D (5.75" x 16.75" x 14.75").

Weight: net 8.2 kg (18 lbs). Shipping 11.3 kg (25 lbs).

**339A Distortion Measurement Set
Option 001**

**\$2300
add \$250**

SIGNAL ANALYZERS

Distortion Analyzers

Models 331A, 333A, 334A

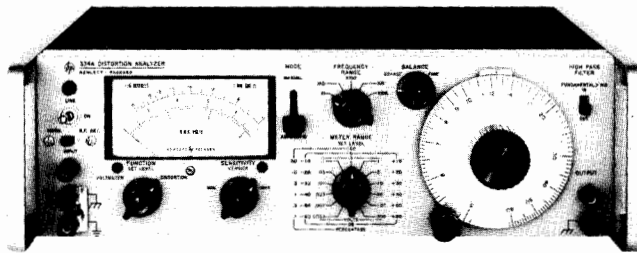

334A

Description

Hewlett-Packard's models 331A, 333A and 334A Distortion Analyzers measure total distortion down to 0.1% full scale at any frequency between 5 Hz to 600 kHz; harmonics are indicated up to 3 MHz. These instruments measure noise as low as 25 microvolts and measure voltages over a wide range of level and frequency. Refer to table below for available models and features.

Model No.	Auto Nulling	Hi-Pass Filter	Lo-Pass Filter	AM Detector
331A				
333A	X	X		
334A	X	X		X
334A Opt. 002	X		X	X

Option 001, for each model, features VU meter characteristics conforming to FCC requirements.

Automatic Fundamental Nulling

The automatic mode is used to complete rejection of the fundamental on more sensitive ranges after manually nulling to <10% of the Set Level Reference.

High-pass Filter

In order to reduce the effect of hum components, a switchable high pass filter is provided which attenuates frequencies below 400 Hz.

Amplitude Modulation Detector

HP's model 334A Analyzer is provided with an amplitude modulation detector having a frequency range from 550 kHz to 65 MHz. The high impedance dc restoring peak detector measures distortion at carrier levels as low as 1 volt. Input to the detector is located on the rear of the instrument.

VU Option Available

Option 001 provides an indicating meter having VU ballistic characteristics which meets FCC requirements.

Model 344A Opt 002

The 334A Opt 002 has a switchable 30 kHz low pass filter to reduce effect of unwanted high frequencies (noise, etc.) when measuring low frequency signals with high accuracy.

331A Specifications

Input level for distortion measurements: 0.3 V rms for 100% set level or 0.245 V for 0 dB set level (up to 300 V may be attenuated to set level reference).

Harmonic measurement accuracy (full scale)
Fundamental Input Less Than 30 V

Range	±3%	±6%	±12%
100%-0.3%	10 Hz-1 MHz	10 Hz-3 MHz	
0.1%	30 Hz-300 kHz	20 Hz-500 kHz	10 Hz-1.2 MHz

Fundamental Input Greater Than 30 V

Range	±3%	±6%	±12%
100%-0.3%	10 Hz-300 kHz	10 Hz-500 kHz	10 Hz-3 MHz
0.1%	30 Hz-300 kHz	20 Hz-500 kHz	10 Hz-1.2 MHz

Elimination characteristics: fundamental rejection >80 dB. Second harmonic accuracy for a fundamental of 5 to 20 Hz; better than +1 dB; 20 Hz to 20 kHz: better than ±0.6 dB; 20 kHz to 100 kHz: better than -1 dB; 100 kHz to 300 kHz: better than -2 dB; 300 kHz to 600 kHz: better than -3 dB.

Distortion introduced by instrument: > -70 dB (0.03%) from 5 Hz to 200 kHz. >-64 dB (0.06%) from 200 kHz to 600 kHz. Meter indication is proportional to average value of a sine wave.

Frequency calibration accuracy: better than ±5% from 5 Hz to 300 kHz. Better than ±10% from 300 to 600 kHz.

Input impedance: distortion mode; 1 MΩ ± 5% shunted by <70 pF (10 MΩ shunted by <10 pF with HP 10001A 10:1 divider probe).

Voltmeter mode: 1 MΩ ± 5% shunted by <35 pF, 1 to 300 V rms; 1 MΩ ± 5% shunted by <70 pF, 300 μV to 0.3 V rms.

DC isolation: signal ground may be ±400 V dc from external chassis.

Voltmeter range: 300 μV to 300 V rms full scale (13 ranges) 10 dB per range. Average responding calibrated in rms.

Voltmeter accuracy: (using front panel input terminals)

Range	±2%	±5%
300 μV	30 Hz-300 kHz	20 Hz-500 kHz
1 mV-30 V	10 Hz-1 MHz	5 Hz-3 MHz
100 V-300 V	10 Hz-300 kHz	5 Hz-500 kHz

Noise measurements: voltmeter residual noise on the 300 μV range: <25 μV rms, when terminated in 600 (shielded) ohms, <30 μV rms terminated with a shielded 100 kΩ resistor.

Output: 0.1 ± 0.01 V rms open circuit.

Output impedance: 2 kΩ.

Power supply: 115 or 230 V ± 10%, 48 to 66 Hz, approximately 4 VA.

333A Specifications

Same as Model 331A except as indicated below:

Automatic nulling mode: set level: at least 0.2 V rms

Frequency ranges: X1, manual null tuned to less than 3% set level; total frequency hold-in ±0.5% about true manual null. X10 through X10 k, manual null tuned to less than 10% of set level; total frequency hold-in ±1% about true manual null.

Automatic null accuracy: 5 Hz to 100 Hz: meter reading within 0 to +3 dB of manual null. 100 Hz to 600 kHz: meter reading within 0 to +1.5 dB of manual null.

High-pass filter: 3 dB point at 400 Hz with 18 dB per octave roll off. 60 Hz rejection: 40 dB.

334A Specifications

Same as Model 333A except as indicated below:

AM detector: frequency range: from 550 kHz to 65 MHz.

Maximum input: 40 V p-p AC or 40 V peak transient.

Distortion introduced by detector: carrier frequency: 550 kHz-1.6 MHz: <50 dB (0.3%) for 3-8 V rms carriers modulated 30%. 1.6 MHz-65 MHz: <40 dB (1%) for 3-8 V rms carriers modulated 30%.

Note: Distortion introduced at carrier levels as low as 1 Volt is normally <40 dB (1%) 550 kHz to 65 MHz for carriers modulated 30%.

General

Size: 426 mm W x 126 mm H x 337 mm D (16.75" x 5" x 13.25").

Weight: net, 7.98 kg (17.75 lb). Shipping, 10.35 kg (23 lb).

Ordering Information

	Price
331A Distortion Analyzer	\$1650
333A Distortion Analyzer	\$1800
334A Distortion Analyzer	\$1900
Option 001	add \$25
Option 002 (334A only)	add \$125
Option 003 (combined 001 and 002, 334A only)	add \$150

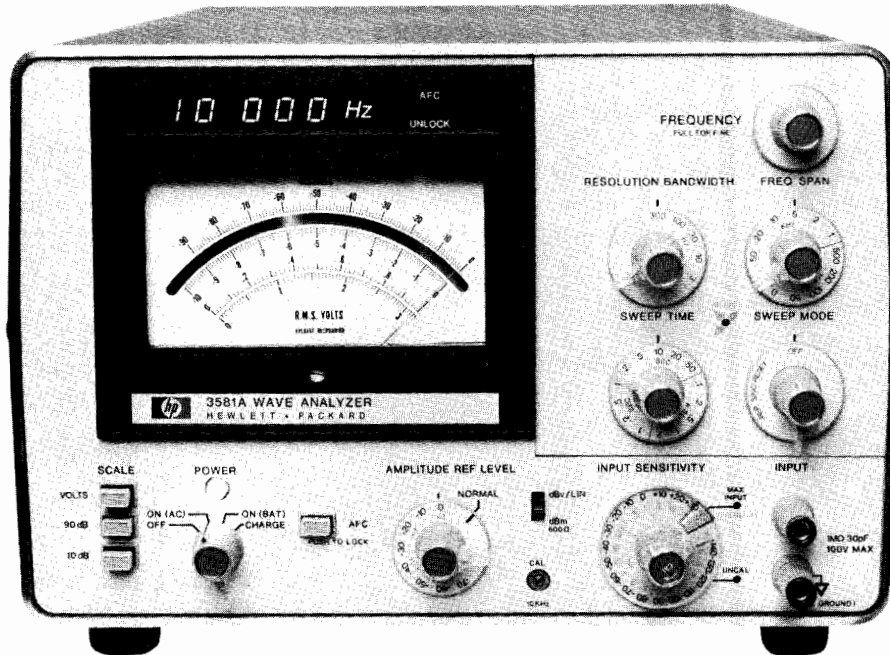

Description

Hewlett-Packard's 3581A Wave Analyzer resolves and measures the amplitude and frequency of spectral components. This instrument offers accurate amplitude and good frequency resolution in the form of a portable, easy to use measuring tool. Since not all signals originate from a stable frequency source, the 3581A incorporates an AFC circuit which locks to a drifting signal for stable, accurate measurements.

HP's 3581A has other important features that are necessary when making measurements of small voltages from transducers and harmonic signals. Its 30 nV sensitivity becomes important for these measurements. Battery operation can be used to reduce the line related interference common in low level measurements so only the real spectrum is measured.

Digital readout of tuned frequency is located above the analog meter. It has been grouped with the meter for ease of reading. Resolution of the digital readout is 1 Hz for any frequency between 15 Hz and 50 kHz. Readout is updated five times per second so delay between tuning and reading is minimized.

Four meter scales are used to provide a wide range of displays. Two scales are used for linear voltage readings. Two log scales provide either a 90 dB or 10 dB display. In any case, the large meter with its mirror backing can present readings in dBV, dBm or volts. A meter was specifically chosen for amplitude display rather than digital readout because it is easier to peak a meter reading and because it's much easier to get a feel for noise or other amplitude variations by watching the meter. The same voltage used to drive the meter is also available on the rear panel for driving X-Y recorders.

Specifications*

Frequency Characteristics

Range: 15 Hz to 50 kHz.

Display: 5 digit LED readout.

Resolution: 1 Hz.

Accuracy: ± 3.5 Hz., 0 to 55°C.

Typical stability: ± 10 Hz/hr after 1 hour and ± 5 Hz/°C.

Automatic frequency control (AFC) hold-in range: ± 800 Hz.

Amplitude Characteristics

Instrument Range

Linear: 30 V to 100 nV full scale.

Log: +30 dBm or dBV to -150 dBm or dBV.

Amplitude accuracy:

Frequency response,
15 Hz-50 kHz

Log
 ± 0.4 dB

Linear
 $\pm 4\%$

Dynamic range: > 80 dB.

Noise sidebands: greater than 70 dB below CW signal. 10 bandwidths away from signal.

Spurious responses: > 80 dB below input reference level.

Sweep Characteristics

Scan width: 50 Hz to 50 kHz, adjustable in a 1-2-5 sequence from 50 Hz to the full frequency range.

Sweep error light: this LED indicates a sweep that is too fast to capture full response. When the light is on, response will be lower than it should be.

External trigger: a short to ground stops the normal sweep. Opening the short then enables a sweep.

Input Characteristics

Impedance: 1 M Ω , 30 pF.

Maximum input level: 100 V rms, ± 100 V dc.

Output Characteristics

Tracking generator output: (also known as BFO or tracking oscillator output).

Range: 0 to > 1 V rms into 600 Ω .

Frequency response: $\pm 3\%$ 15 Hz to 50 kHz.

X-Y Recorder Analog Outputs

Vertical: 0 to +5 V $\pm 2.5\%$.

Horizontal: 0 to +5 V $\pm 2.5\%$.

Impedance: 1 k Ω .

Pen lift: contact closure to ground during sweep.

Restored output: acts as a narrow band amplifier.

General

Power requirements: 100 V, 120 V, 220 V, or 240 V $\pm 5\% - 10\%$, 48 Hz to 440 Hz, 10 VA typical.

Size: 412.8 mm H x 203.2 mm W x 285.8 mm D (16 $\frac{1}{4}$ " x 8" x 11 $\frac{1}{4}$ ").

Weight: 11.5 kg (23 lb). Opt 001: 13.5 kg (30 lb).

Options

001: Internal battery 12 hours from full charge. Internal battery is protected from deep discharge by an automatic turnoff. Useful battery life is over 100 cycles.

910: Extra set manuals

Price

add \$500

add \$20

3581A Wave Analyzer

\$4350

SIGNAL ANALYZERS

Modulation Analyzer, 150 kHz to 1300 MHz

- Measures AM and FM to 1% accuracy
- Measures RF frequency
- Measures peak envelope power
- Low internal noise
- Completely automatic
- Optional built-in AM & FM calibrators



8901A (with Option 010)



8901A Modulation Analyzer

The 8901A Modulation Analyzer combines the capabilities of several RF instruments to give a complete, accurate characterization of modulated signals in the 150 kHz to 1300 MHz frequency range. It very accurately measures modulation and recovers the modulation signal. It determines RF frequency with 10 or 100 Hz resolution. It also measures RF peak power and in many instances eliminates the need for a power meter. The analyzer is ideally suited for characterization of transceivers and for metrology applications in calibrating precision signal generators. Some other uses may be less obvious, for example, it can be used to measure mixer compression or to measure VCO FM sensitivity. The fully automatic 8901A makes all major measurements with the push of a single key or under HP-IB control. Hewlett-Packard Interface Bus (HP-IB) control is a standard feature. Further description and example waveforms of the 8901A are on pages 578 and 579 of this catalog.

Modulation Measurement Accuracy

Very accurate modulation measurements along with very low internal noise enable the 8901A to characterize even high performance signal sources. Its detection system is configured for wideband recovery of the entire modulation spectrum so that highly precise measurements such as signal-to-noise or distortion can be made on the modulation signal. Modulation depth and deviation accuracy is generally $\pm 1\%$ of reading. Residual AM noise in a 50 Hz to 3 kHz bandwidth is $<0.01\%$ while FM noise is <8 Hz for 1300 MHz carrier frequencies, decreasing linearly to <1 Hz below 100 MHz. Because the AM and FM demodulators are independent and highly insensitive to each other and because the analyzer has very low residual AM and FM, accurate incidental AM and FM measurements can be made.

Three detectors are available for depth and deviation measurements: positive peak, negative peak, and an average-responding detector with rms (sinewave) calibration. The average detector is ideal for the determination of residual noise on a signal. A PEAK HOLD

function captures and displays the maximum peak modulation of a signal and is ideal for making transient measurements such as modulation limiting on mobile radios. It can capture even very short transients and hold their peaks indefinitely.

For measuring convenience, two high-pass (50 Hz and 300 Hz) and three low-pass (3 kHz, 5 kHz, and >20 kHz) post-detection filters for filtering the recovered modulation are included. The >20 kHz Bessel filter minimizes overshoot on square wave modulation. This allows accurate measurement of signals which are digitally modulated, such as FSK.

Four de-emphasis networks commonly used in FM systems (25, 50, 75, and $750 \mu\text{s}$) are provided. When chosen, the de-emphasis networks always affect the demodulated output but the user can select whether or not the de-emphasis network affects the deviation measured and indicated by the display.

A modulation output provides calibrated signal levels relative to the displayed modulation reading. Further measurements (frequency, distortion, frequency response) can be made on this demodulated signal with the HP 8903A Audio Analyzer described on page 581.

Option 010 provides two precision modulation standards. One is an amplitude modulated signal whose depth is calibrated to better than 0.1% accuracy. The second standard is a frequency modulated signal with peak deviation calibrated to $>0.1\%$ accuracy. Because the calibrator can be included in the analyzer, metrology laboratories are not required to purchase a separate standard for AM or FM accuracy calibration. The 11715A AM/FM Test Source is necessary to fully test and calibrate other modulation parameters of the 8901A and is described on the next page.

Complete Signal Characterization

The 8901A Modulation Analyzer is more than just a high quality modulation meter. It also performs as a frequency counter and RF power meter. Resolution for the 150 kHz to 1300 MHz frequency counter is 10 Hz below 1000 MHz and 100 Hz above 1000 MHz. Sensitivity is -25 dBm (12 mV rms) below 650 MHz and -20 dBm



(22 mV rms) above 650 MHz, with a dynamic range of >50 dB. The standard instrument's time base stability is $<1 \times 10^{-6}$ /month or an optional time base is available with $<1 \times 10^{-9}$ /day stability.

The Modulation Analyzer automatically adjusts the internal level of the signal for optimum measurement. It can also selectively measure signals other than the largest with the approximate frequency entered via the keyboard. This is done with an unprecedented sensitivity of 0.22 mV rms and dynamic range of >90 dB. Input protection from damage is provided for signals up to 25 W with clamping diodes and a relay.

The 8901A uses a diode detection circuit to measure RF input power. This technique measures peak voltage and is calibrated from 1 mW to 1W for sine wave inputs.

Another function, TUNED RF LEVEL, configures the modulation analyzer as a selective RF power meter, allowing relative measurements of only signal levels in the tuned IF filter passband prior to automatic leveling. The 8901A has two selectable IF filters: one at 1.5 MHz with a 3 MHz nominal 3 dB bandwidth; the other at 455 kHz with a 200 kHz nominal 3 dB bandwidth.

Ease of Operation

The 8901A Modulation Analyzer provides unexcelled accuracy while remaining extremely easy to use. Under control of an internal microprocessor, the 8901A is fully automatic and autoranging. Most measurements require only a single keystroke. There is no need to tune the analyzer, adjust levels, or select the appropriate range. Data processing routines of the microprocessor permit the user to make measurements relative to a measured value or to one entered from the keyboard by using the ratio keys.

Special Functions

Special functions entered using the numerical keys and the special function key give the operator manual control of functions, operation, and service aids. For example, one special function configures the instrument to continuously track the input signal as it changes frequency without losing frequency lock. Using this special function, a user can continuously monitor modulation accuracy on a signal generator while tuning across the signal generator's frequency band.

8901A Specifications

RF Input

Frequency range: 150 kHz to 1300 MHz

Operating level:

150 kHz–650 MHz: 12 mVrms to 7 Vrms

650 MHz–1300 MHz: 22 mVrms to 7 Vrms

Input impedance: 50Ω nominal

Tuning: Manual frequency entry, automatic, or track (frequencies >10 MHz only).

Acquisition time (automatic operation): ~1.5 seconds.

Maximum safe input level (typical): ac: 35 Vrms (25 W for source SWR <4); dc: 40V.

Frequency Modulation

Rates:

150 kHz–10 MHz: 20 Hz to 10 kHz

10 MHz–1300 MHz: 20 Hz to 200 kHz

10 MHz–1300 MHz: 20 Hz to 20 kHz with 750 μs filter.

Deviations:

150 kHz–10 MHz: 40 kHz peak maximum

10 MHz–1300 MHz: 400 kHz peak maximum

10 MHz–1300 MHz: 40 kHz peak maximum with 750 μs filter.

Accuracy¹:

250 kHz–10 MHz: $\pm 2\%$ of reading ± 1 digit, 20 Hz to 10 kHz rates.

10 MHz–1300 MHz: $\pm 1\%$ of reading ± 1 digit, 30 Hz to 100 kHz rates; $\pm 5\%$ of reading ± 1 digit, 20 Hz to 200 kHz rates.

Demodulated output distortion:

250 kHz–10 MHz: <0.1% THD, deviations <10 kHz.

10 MHz–1300 MHz: <0.1% THD, rates and deviations <100 kHz.

AM rejection (for 50% AM at 400 Hz and 1 kHz rates)¹:

<20 Hz peak deviation measured in a 50 Hz to 3 kHz BW.

Residual FM (50 Hz to 3 kHz BW): <8 Hz rms @ 1300 MHz, decreasing linearly with frequency to <1 Hz rms for 100 MHz and below.

¹Peak residuals must be accounted for in peak readings.

²For peak measurements only, AM accuracy may be affected by distortion generated by the Modulation Analyzer. In the worst case, this can decrease accuracy by 0.1% of reading for each 0.1% of distortion.

³After 30 day warm-up.

Maximum deviation resolution:

1 Hz, <4 kHz deviation

10 Hz, 4 kHz to 40 kHz deviation

100 Hz, 40 kHz to 400 kHz deviation

Resolution is increased one digit with 750 μs deemphasis and predisplay "on."

Stereo separation (50 Hz to 15 kHz): >47dB typical.

Phase Modulation

Carrier frequency: 10 MHz to 1300 MHz.

Rates: 200 Hz to 20 kHz; typically useable from 20 Hz to 100 kHz with degraded performance.

Deviation and maximum resolution:

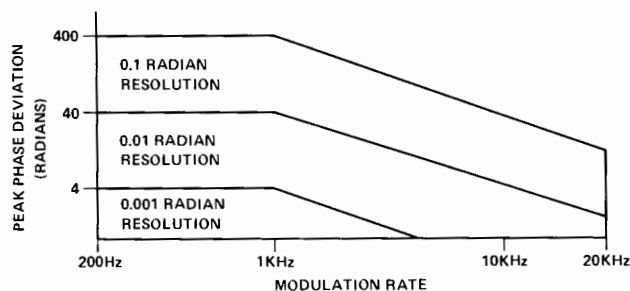

Accuracy: $\pm 3\%$ of reading ± 1 digit

Demodulated output distortion: <0.1% THD

AM rejection (for 50% AM at 1 kHz rate)¹: <0.02 radian peak (50 Hz to 3 kHz BW)

Amplitude Modulation

Rates:

150 kHz–10 MHz: 20 Hz to 10 kHz

10 MHz–1300 MHz: 20 Hz to 100 kHz.

Depth: to 99%

Accuracy^{1,2}:

150 kHz–10 MHz: $\pm 2\%$ of reading ± 1 digit,

50 Hz to 10 kHz rates, >5% depth;

$\pm 3\%$ of reading ± 1 digit, 20 Hz to 10 kHz rates.

10 MHz–1300 MHz: $\pm 1\%$ of reading ± 1 digit,

50 Hz to 50 kHz rates, >5% depth;

$\pm 3\%$ of reading ± 1 digit, 20 Hz to 100 kHz rates.

Flatness (variation in indicated AM depth for constant depth on input signal): 10 MHz to 1300 MHz: $\pm 0.2\%$ of reading ± 1 digit, 90 Hz to 10 kHz rates, 20 to 80% depth.

Demodulated output distortion: <0.3% THD for $\leq 50\%$ depth; <0.5% THD for $\leq 95\%$ depth.

FM rejection (at 400 Hz and 1 kHz rates, 50 Hz to 3 kHz BW)¹:

250 kHz to 10 MHz: <0.2% AM for <5 kHz peak deviation.

10 MHz to 1300 MHz: <0.2% AM for <50 kHz peak deviation.

Residual AM (50 Hz to 3 kHz BW): <0.02% rms.

Maximum depth resolution:

0.01% for depths $\leq 39.99\%$; 0.1% for depths $\geq 40\%$.

Frequency Counter

Range: 150 kHz–1300 MHz.

Accuracy: reference accuracy ± 3 digits.

Internal reference:

Frequency: 10 MHz.

Ageing rate: $<1 \times 10^{-6}$ /month (optional³: $<1 \times 10^{-9}$ /day).

Maximum resolution:

10 Hz for frequencies <1 GHz; 100 Hz for frequencies ≥ 1 GHz.

RF Level (Peak Voltage Responding, RMS Sine Wave Power Calibrated)

Range: 1 mW to 1W

Instrumentation accuracy: ± 2.0 dB (≤ 650 MHz);

± 3.0 dB (> 650 MHz); 1.0 dB typical.

SWR: <1.5 in a 50Ω system.

Resolution:

0.1 mW for levels 0.1 to 1W

0.01 mW for levels 0.01 to 0.1W

0.001 mW for levels <0.01W.

Audio Filters

High pass (3 dB cutoff frequency): 50 Hz and 300 Hz
Low pass (3 dB cutoff frequency except >20 kHz filter): 3 kHz, 15 kHz, >20 kHz

De-emphasis filters: 25 μ s, 50 μ s, 75 μ s, and 750 μ s.

Flatness:

50 Hz High Pass: <1% at rates \geq 200 Hz
 300 Hz High Pass: <1% at rates \geq 1 kHz
 3 kHz Low Pass: <1% at rates \leq 1 kHz
 15 kHz Low Pass: <1% at rates \leq 10 kHz
 >20 kHz Low Pass: <1% at rates \leq 10 kHz

Calibrators (Option 010)

AM calibrator depth and accuracy: 33.33% depth, nominal; internally calibrated to an accuracy of \pm 0.1%

FM calibrator deviation and accuracy: 33 kHz peak deviation, nominal; internally calibrated to an accuracy of \pm 0.1%

General Characteristics

Operating temperature range: 0° to 55°C

Power requirements: 100, 120, 220, or 240V ac (+5, -10%); 48-66 Hz; 200 VA max.

Weight: net, 20 kg (44 lb); shipping, 25 kg (55 lb)

Size: 190 mm H x 425 mm W x 468 mm D (7.5 in. x 16.8 in. x 18.4 in.)

11715A AM/FM Test Source

The 11715A AM/FM Test Source provides very flat, wide-bandwidth, and low distortion amplitude or frequency modulated RF signals. Designed primarily for performance tests and adjustments of the 8901A Modulation Analyzer, it will also serve as a high quality modulated test oscillator where its frequency ranges apply.

The major components of the 11715A are a low-noise voltage controlled oscillator (VCO), two digital dividers, and a double balanced mixer. The VCO is the primary signal source, with a typical frequency range of 330 to 470 MHz at the FM OUTPUT. FM is produced by directly coupling the external modulation source to the VCO's tune input, providing very wide bandwidth modulation with low phase shift. This design also ensures very little incidental AM. The digital dividers derive the two lower frequency ranges from the FM modulated VCO output. The AM mode routes the external modulation signal directly to the mixer, which modulates the VCO divide-by-32 signal. This amplitude modulated carrier has very low incidental phase modulation. A separate crystal oscillator and frequency doubler provide a low-residual FM output at 560 MHz.

The 11715A can also be used in conjunction with an 8901A as a calibrated signal source for special applications. In particular, the U.S. commercial FM broadcast band of 88 to 108 MHz is covered by the FM \div 4 OUTPUT of the 11715A. Typical stereo separation of 60 dB with very low distortion can be obtained over the full range of broadcast modulation requirements.

11715A Specifications**FM Outputs****Frequency Range**

AM FM \div 32 output: 11 to 13.5 MHz

FM \div 4 output: 88 to 108 MHz

FM output: 352 to 432 MHz

Peak Deviation

11 to 13.5 MHz carrier: >12.5 kHz

88 to 108 MHz carrier: >100 kHz

352 to 432 MHz carrier: >400 kHz

Distortion

<0.025% THD (<-72 dB) for

Carrier frequency	Peak deviation	Modulation rate
12.5 MHz	12.5 kHz	<10 kHz
100 MHz	100 kHz	<100 kHz
400 MHz	400 kHz	<100 kHz

Flatness

dc to 100 kHz rates: \pm 0.1%

dc to 200 kHz rates: \pm 0.25%

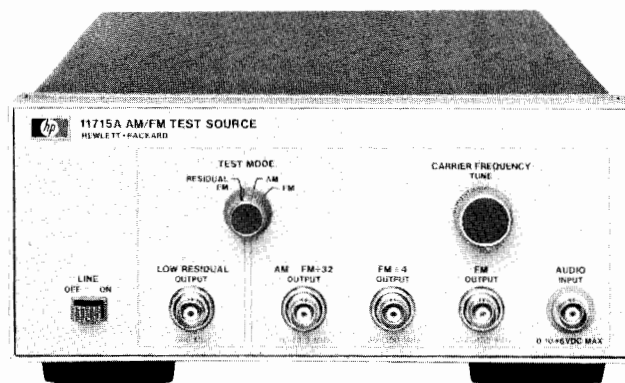

11715A

Incidental AM (100 MHz carrier, <50 kHz peak deviation, 1 kHz rate, 50 Hz to 3 kHz bandwidth): <0.08%

Residual FM (typical, 50 Hz to 15 kHz bandwidth)

12.5 MHz: <1 Hz rms

100 MHz: <8 Hz rms

400 MHz: <32 Hz rms

Stereo separation (88 to 108 MHz carrier, 75 kHz peak deviation, 1 kHz rate): >60 dB typical

AM Output

Frequency range (AM FM \div 32 output): 11 to 13.5 MHz

Depth: to 99%

Distortion

50% AM, 20 Hz to 100 kHz rates: <0.05% THD (<-66 dB)

95% AM, 20 Hz to 100 kHz rates: <0.1% THD (<-60 dB)

Flatness

50 Hz to 50 kHz rates: \pm 0.1%

20 Hz to 100 kHz rates: \pm 0.25%

Incidental \emptyset M (12.5 MHz carrier, 50% AM, 1 kHz rate, 50 Hz to 3 kHz bandwidth): <0.008 radian peak

Linearity

\leq 95% AM: \pm 0.1%

\leq 99% AM: \pm 0.2%

Residual AM (50 Hz to 3 kHz bandwidth): <0.01% rms

Low Residual Output

Residual FM (50 Hz to 3 kHz bandwidth): <3 Hz rms

Frequency: 560 MHz \pm 50 kHz nominal

General**Line Voltage**

48 to 440 Hz: 100 to 120 Vac (+5%, -10%)

48 to 66 Hz: 220 to 240 Vac (+5%, -10%)

Power dissipation: 40 VA maximum.

Weight: net 4.4 kg (9.5 lb); shipping 6.5 kg (14 lb)

Size: 102 mm H x 212 mm W x 444 mm D (4.0 x 8.4 x 17.5 in.)

Temperature

Operating: 0 to 55°C

Storage: -55 to 75°C

Ordering Information

8901A Modulation Analyzer

Price

\$8700

(Note: HP-IB cable not supplied. See page 30.)

Option 010: Rear panel instead of front panel connectors add \$100

Option 002: 1 \times 10⁻⁹/day internal reference oscillator add \$650

Option 003: Rear panel connections for external local oscillator add \$200

Option 004: Operation from 48 to 440 Hz power line (100-120V ac only) add \$175

Option 010: AM and FM calibrators add \$525

Option 907: Front panel handle kit add \$40

Option 908: Rack mounting flange kit add \$30

Option 909: Front panel handle and rack mounting flange kit add \$65

Option 910: Extra operating & service manual add \$25

11715A AM/FM Test Source \$1750

Option 907: Front panel handle kit add \$28

Option 910: Extra operating & service manual add \$3.50

Rack mounting kit: (P/N 5061-0072) add \$30

SIGNAL ANALYZERS

Audio Analyzer, 20 Hz to 100 kHz

Model 8903A



- Measures distortion, SINAD, signal-to-noise
- Measures true rms volts, dc volts, frequency

- Programmable low distortion source

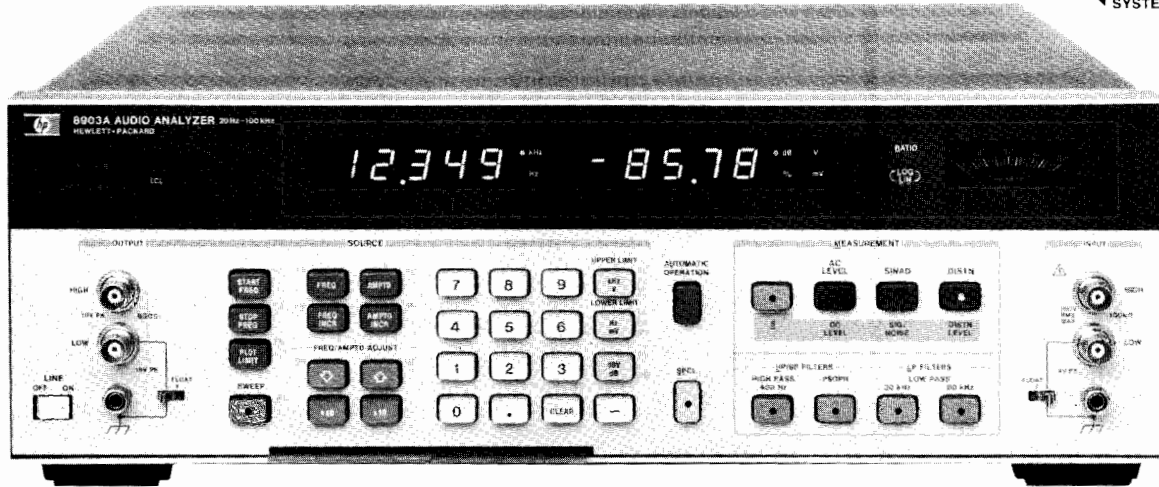

8903A

8903A Audio Analyzer

The 8903A Audio Analyzer combines the capabilities of several instruments under microprocessor control to yield accurate and rapid characterizations of audio signals in the range of 20 Hz to 100 kHz. It contains an audio source, measures distortion, SINAD, and signal-to-noise ratio, ac and dc level, and counts frequency completely automatically with either a single front panel keystroke or under HP-IB remote control. This combination reduces the number of instruments and complexity of setup needed in many applications.

The analyzer is ideally suited for performing audio measurements on transceivers. Along with a suitable signal generator and modulation analyzer, receiver sensitivity and transmitter distortion measurements can be made accurately and rapidly.

With the internal source and measurement functions enhanced by microprocessor control, the 8903A has more measurement capability and less display ambiguity than separate instruments. The Audio Analyzer makes true rms measurements for ac level and distortion, thus assuring more accurate measurements of complex waveforms and noise. The ability to perform swept measurements makes it an extremely versatile stand-alone bench instrument for general audio stimulus/response work. Its programmability over HP-IB is well suited to system applications.

Transceiver Testing

The Audio Analyzer performs several measurements and contains various features specifically designed for receiver testing. The most common audio measurements are SINAD for FM receivers and signal-to-noise for AM receivers. In the 8903A, these measurements are optimized for measuring the noisy signals encountered in receiver testing. Measurements of SINAD are indicated both by the analog meter and the digital display. The specially marked meter for EIA and CEPT sensitivity and selectivity results in fast, accurate, repeatable measurements. Also, a psophometric filter allows testing to CEPT standards.

By combining the 8903A with the 8901A Modulation Analyzer, you can make all common transmitter tests. The 8903A provides the tone for microphone inputs, measures transmitter audio distortion, and counts squelch tones. Distortion measurements can be made using the 400 Hz high pass filter to reject squelch tones. In rapid frequency count mode, counter measurements can be made at a rate of 8 ms/reading, allowing burst counting of squelch tone frequencies. In rapid source mode, the 8903A can switch frequencies rapidly enough to generate multiple tone squelch sequences. All functions are remotely programmable.

Audio Testing

The 8903A simplifies general audio testing by combining several traditional audio instruments into one. It is fully automatic and autoranging, so most measurements take only a single keystroke. Microprocessor control of all functions greatly enhances measurement flexibility. For example, distortion can be displayed in either percent or dB. In ac level you can choose between volts, dBV, or watts by entering the load resistance from the keyboard. You can establish a reference and make measurements in percent or dB relative to a measured or entered value. Using the source increment/decrement keys and relative display mode it is easy to determine parameters such as the 3 dB points of filters and amplifiers. With both low-distortion source and analyzer built in, the 8903A makes stimulus-response measurements. Internal processor control over all functions expands this capability to powerful swept characterization. With only a few keystrokes you can measure frequency response and swept distortion characteristics of filters, high quality amplifiers, audio IC's, and other devices. Hard copy results are easily generated with an X-Y recorder connected to the analyzer's rear panel outputs.

Systems Applications

The Audio Analyzer is a powerful HP-IB system component. Many low frequency functions frequently required in automatic systems are combined in the 8903A. In many cases it does the work of an audio synthesizer, digital voltmeter, frequency counter, and custom interface with notch filters. All measurements are available at a single input connector. As a result, interfacing requirements, hardware cost, and software development time are reduced. The 8903A makes a major contribution by automatically measuring distortion under HP-IB control. It also provides a low distortion programmable source. Typical combined distortion of both source and analyzer at 1V is <math><0.003\%</math> between 20 Hz and 20 kHz.

Often systems applications involve measuring low level ac signals. The 8903's most sensitive range features a full scale ac level display of .300 mV with an accuracy of 4% of reading (2% of reading > 50 mV, 20 Hz to 20 kHz). The ac converter is true rms for correct noise measurements and the 3 dB bandwidth is greater than 500 kHz.

Large measurement systems often have troublesome noise problems. The 8903A has 30 kHz and 80 kHz low-pass filters to reject high frequency noise. Also, the 400 Hz high-pass filter rejects line related hum and noise more than 68 dB. Floating the input or output can break insidious ground loops, and provide up to 60 dB of common mode rejection.

Two special binary programming modes are available in remote operation. Rapid frequency count mode provides a packed four byte output for fast counting. Also, the rapid source mode allows the internal source to be programmed directly with five bytes.

8903A Specifications**Source****Frequency range:** 20 Hz to 100 kHz.**Frequency resolution:** 0.3%**Frequency accuracy:** 0.3% of setting.**Output level range:** 0.6 mV to 6V open circuit.**Output level resolution:** 0.3% or better.**Output level accuracy (open circuit):** 2% of setting, 60 mV to 6V, 20 Hz to 50 kHz; 3% of setting, 6 mV to 6V, 20 Hz to 100 kHz; 5% of setting, 0.6 mV to 6 mV, 20 Hz to 100 kHz.**Flatness (1 kHz reference):** $\pm 0.7\%$, 20 Hz to 20 kHz; $\pm 2.5\%$, 20 Hz to 100 kHz.**Distortion & noise:** the higher of: -80 dB or $30 \mu\text{V}$, 20 Hz to 20 kHz, 80 kHz BW; -70 dB or $95 \mu\text{V}$, 20 kHz to 50 kHz, 500 kHz BW; -65 dB or $169 \mu\text{V}$, 50 kHz to 100 kHz, 500 kHz BW.**Impedance:** $600\Omega \pm 1\%$.**Sweep mode:** logarithmic sweep with up to 500 points/decade or 255 points between entered start and stop frequencies, whichever is smaller.**AC Level****Full range display:** 300.0V, 30.00V, 3.000V, 0.3000V, 30.00mV, 3.000 mV, 0.3000mV.**Overrange:** 33% except on 300V range.**Accuracy:** $\pm 2\%$ of reading, 30V to 300V, 20 Hz to 1 kHz; $\pm 2\%$ of reading, 50 mV to 30V, 20 Hz to 20 kHz; $\pm 4\%$ of reading, 0.3 mV to 30V, 20 Hz to 100 kHz.**AC Converter:** true-rms responding for signals with crest factor ≤ 3 and harmonics up to 80 kHz typical. 3 dB measurement BW: > 500 kHz typical.**DC Level****Full range display:** 300.0V, 48.00 V, 16.00V, 4.00V.**Overrange:** 33% except on 300V range.**Accuracy:** $\pm 0.75\%$ of reading, 400 mV to 300V; ± 3 mV, < 400 mV.**Distortion****Fundamental frequency range:** 20 Hz to 100 kHz.**Display range:** 0.001% to 100%, -99.99 dB to 0 dB.**Accuracy:** ± 1 dB, 20 Hz to 20 kHz; ± 2 dB, 20 kHz to 100 kHz.**Input voltage range:** 50 mV to 300V.**Residual noise and distortion:** the higher of: 0.01%, -80 dB, or $30 \mu\text{V}$, 20 Hz to 20 kHz, 80 kHz BW; 0.032%, -70 dB, or $95 \mu\text{V}$, 20 kHz to 50 kHz, 500 kHz BW; 0.056%, -65 dB, or $169 \mu\text{V}$, 50 kHz to 100 kHz, 500 kHz BW.**Displayed resolution:** 0.0001%, $< 0.1\%$ distortion; 0.001%, 0.1% to 3% distortion; .01%, 3% to 30% distortion; 0.1%, $> 30\%$ distortion.**Detection:** true rms.**SINAD^{1,2}****Fundamental frequency range:** 20 Hz to 100 kHz.**Display range:** 0 dB to 99.99 dB.**Accuracy:** ± 1 dB, 20 Hz to 20 kHz; ± 2 dB, 20 kHz to 100 kHz.**Input voltage range:** 50 mV to 300V.**Detection:** true rms (average detection selectable by internal jumpers).**Resolution:** 0.01 dB for SINAD ratios > 25 . For ratios < 25 the display is rounded to the nearest half dB to reduce digit flickering of noise signals. (Full resolution is available by defeating this feature using special function 16.1).**Analog meter:** active in SINAD only and for SINAD ratios < 18 dB (or 24 dB using special function 7.1).**Tuning:** notch filter is tuned to analyzer source frequency.**Signal to Noise****Frequency range:** 20 Hz to 100 kHz.**Display range:** 0 dB to 99.99 dB.**Accuracy:** ± 1 dB.¹SINAD is a sensitivity measurement computed from the ratio of signal plus noise and distortion to noise and distortion.²Residual noise and distortion same as for distortion mode.**Input voltage range:** 50 mV to 300V.**Residual noise:** the higher of -80 dB or $30 \mu\text{V}$, 80 kHz BW; -70 dB or $95 \mu\text{V}$, 500 kHz BW.**Resolution:** same as SINAD.**Operation:** the analyzer displays the ratio of the input voltages as the internal source is automatically switched on and off.**Frequency Counter****Range:** 20 Hz to 150 kHz³.**Resolution:** 5 digits⁴.**Accuracy:** $0.004\% \pm 1$ digit.**Input sensitivity:** 50 mV in distortion and SINAD modes, 5.0 mV in ac level and sig/noise modes.**Counting technique:** reciprocal with 2 MHz timebase.**Audio Filters****400 Hz high pass filter:** 3 dB cutoff frequency, 400 Hz ± 40 Hz; 140 dB/decade rolloff.**Psophometric filter (CCITT recommendation P53):** deviation from ideal response: ± 0.2 dB at 800 Hz; ± 1 dB, 300 kHz to 3 kHz; ± 2 dB, 50 Hz to 3.5 kHz; ± 3 dB, 3.5 kHz to 5 kHz.**30 kHz low pass filter:** 3 dB cutoff frequency, 30 kHz ± 2 kHz; 60 dB/decade rolloff.**80 kHz low pass filter:** 3 dB cutoff frequency, 80 kHz ± 4 kHz; 60 dB/decade rolloff.**Rear Panel Inputs/Outputs****Recorder output:** X: 0-10 Vdc (typical) corresponding to log of oscillator frequency.

Y: 0-10 Vdc (typical) corresponding to displayed value and entered plot limits.

Recorder output resistance: 1 k Ω nominal.**Monitor output:** in ac level mode provides scaled output of measured input signal. In SINAD, distortion, and distortion level modes provides scaled output of input signal with the fundamental removed.**General****Input impedance:** 100k $\Omega \pm 1\%$ shunted by < 300 pF with low terminal grounded⁵.**CMRR (@ 60 Hz):** 60 dB for differential input < 2 V; 36 dB for differential input < 48 V; 30 dB for differential input > 48 V.**Remote operation:** HP-IB, all functions except the line switch, low terminal ground switches, and the $\times 10 \div 10$ increment keys.**HP-IB compatibility, as defined in IEEE-488-1978, is:** SH1, AH1, T5, TE0, L3, LE0, SR1, RL1, PP0, DC1, DT1, C0.**Temperature:** operating, 0° to 55°C; storage, -55°C to 75°C.**Power requirements:** 100, 120, 220, or 240 volts (+5, -10%); 48-440 Hz; 100 VA maximum.**Weight:** net, 12.3 kg (27 lb); shipping, 16.4 kg (36 lb).**Size:** 146 H x 425 W x 440 mm D (5.75 x 16.8 x 17.3 in.).**HP System II Module Size:** 5¼ H x 1 MW x 17 D. See pp 714-719 for compatible accessories.**EMI:** conducted and radiated interference is within the requirements of methods CE03 and RE02 of MIL STD 461A, VDE 0871, and CISPR publication 11. Conducted and radiated susceptibility meet the requirements of methods CS01, CS02, and RS03 (1 volt/meter) of MIL STD 461A dated 1968.**Ordering Information****8903A Audio Analyzer****Price****\$6200****(Note:** HP-IB cable not supplied. See page 30.)**Option 001:** Rear panel connections instead of front panel for source output and analyzer input. add \$50**Option 907:** Front panel handle kit add \$32**Option 908:** Rack mount flange kit add \$25**Option 909:** Front panel handle plus rack mount flange kit add \$55**Option 910:** Extra Operating & Service Manual add \$30³20 Hz to 100 kHz in SINAD and distortion.⁴Resolution is limited to 0.01 Hz for input frequencies < 100 Hz.⁵In dc level mode input resistance is 101k $\Omega \pm 1\%$.⁶Input capacitance is < 330 pF for Option 001.



Introduction

Measurements on digital communications systems are often grouped into those performed on the terminal conversion process of the analog signal to PCM and those on the TDM muldex and transmission link carrying the digitally encoded signal. However, with the merging of switching, terminals and transmission in an Integrated Digital Network (IDN), and the emergence of other digitised services, for example digital data, within the context of an Integrated Services Digital Network (ISDN), this division of "terminal" and "transmission" measurements is not always clear or convenient. For example, a digital switch needs to be tested analog-to-analog (A-A), analog-to-digital (A-D) and digital-to-analog (D-A) on its conventional analog voice ports and digital-to-digital (D-D) on the digital ports. With the development of sophisticated conversion devices like transmultiplexers which directly convert signals in the FDM domain to the TDM domain and vice versa, the need has arisen for D-D tests of voice channel parameters such as channel gain, frequency response, noise and quantizing distortion. The objective and subjective effect of transmission parameters such as error ratio and timing jitter on the decoded analog service carried, for example TV, is also becoming more important. It is convenient perhaps to consider measurements of PCM performance separately from those of TDM performance.

PCM Measurements and Test Equipment

Traditionally, primary PCM multiplex equipment has been characterised in terms of voice channel performance by either connecting two terminals back-to-back or looping a single terminal at the digital side. The performance parameters and measurement methods have been standardized by the International Telegraph and Telephone Consultative Committee (CCITT). While this approach to terminal testing has been adequate for local junction or point-to-point systems, the introduction of an IDN requires A-D, D-A and D-D tests to be made in addition to the A-A measurements. The 3779C/D Primary Multiplex Analyzer (PMA) provides this measurement capability in an integrated automatic test set. The instrument can be programmed to execute a complete measurement sequence to stored test limits with pass/fail conditions and print out results on an external printer. Automatic testing of all voice channels in a multiplex can be carried out via the 3777A Channel Selector controlled by the PMA. The PMA also has a general purpose single channel digital interface for testing single channel PCM codecs and digital switching line cards.

TDM Measurements and Test Equipment

Measurements on digital terminal and transmission equipment are aimed at establishing primarily two performance criteria—binary error and timing jitter performance. Error performance can be expressed in various ways, for example bit error ratio (BER),

error-free seconds (EFS), or percentage time for which mean error rate exceeds a given threshold. The standard out-of-service technique of measuring error performance is to stimulate the system with a test pattern, usually a pseudo-random binary sequence (PRBS) and compare the received signal with a locally generated, error-free reference pattern on a bit-by-bit basis. In-service measurements usually monitor fixed known patterns carried within the traffic signal, for example the frame alignment signal of the terminal multiplex, or, in the case of line systems, monitoring errors in the line code. However, the latter method is only valid where no binary signal processing occurs between system input and output.

Jitter performance of a system or subsystem, regenerator, etc, is normally expressed in three ways—input jitter tolerance (ie jitter which can be applied without causing errors), intrinsic output jitter, and jitter transfer function (or jitter frequency response). Jitter tolerance and jitter transfer function are normally measured with the system out of service and applying a jittered test pattern while measuring errors and output jitter. Basic intrinsic output jitter can be measured out-of-service or in-service provided that the jitter meter has some means of recovering a timing reference from the input signal.

HP has an extensive range of error and jitter performance measuring equipment. The 3780A Pattern Generator/Error Detector provides binary and code error measurements in a single portable instrument for bit rates up to 50 Mb/s. A new system compris-

ing the 3781A Pattern Generator and 3782A Error Detector offers error distribution analysis and jitter tolerance testing with full HP-IB control for 704, 2048, 8448 and 34368 kb/s systems to CEPT European standards. A similar 3781B/3782B system is available for testing DS-1, DS-1C, DS-2 and DS-3 levels in the Bell North American digital hierarchy. This system includes the necessary frame structures of the terminal multiplex equipment (except the DS-1C level where it can only be used on T1-C line systems). The error performance measurement systems are now complemented by a new 3785A/B Jitter Generator & Receiver which can be used to measure the jitter performance of CEPT and Bell digital transmission equipment. Comprehensive features including full HP-IB control and jitter analysis in the amplitude, frequency and real-time domains are provided in a compact portable instrument. Error performance measurements on higher speed systems up to 150 Mb/s can be made with the 3762A Data Generator and 3763A Error Detector. The system has specific options for interfacing at the 34368 and 139264 kb/s levels of the CEPT digital hierarchy. The 3762A/3763A have also been designed to operate in burst mode for Time Division Multiple Access (TDMA) satellite applications. For in-service measurements on 2048 kb/s systems, the 3783A 30 Ch PCM Alignment Monitor & Error Detector provides error detection on the frame alignment signal of the primary PCM/TDM muldex and HDB3 line code. It also detects and displays any alarm states present in the signal.

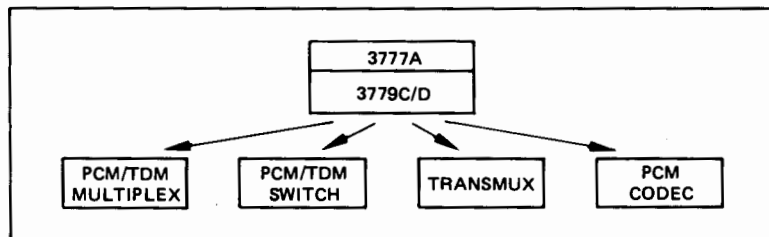

Figure 1. PCM test equipment

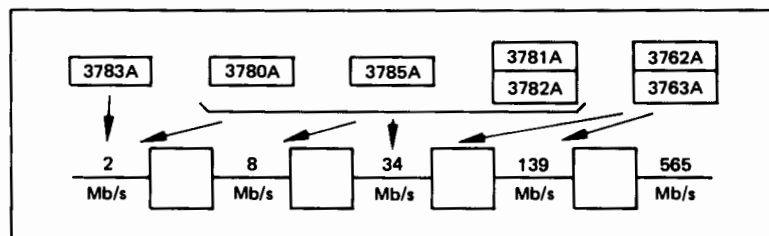

Figure 2. CEPT TDM hierarchy test equipment

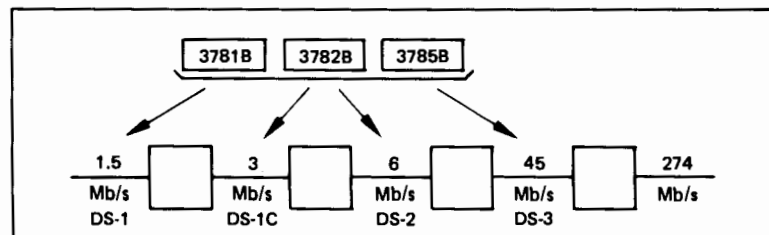

Figure 3. Bell TDM hierarchy test equipment



TELECOMMUNICATIONS TEST EQUIPMENT

Muldex / Channel Bank, Codec, and Digital Switching Line Card Analyzer

Models 3779C, 3779D

- A-A, A-D, D-A and D-D measurements
- Automatic measurement sequencing
- User-level keyboard programming

- Non-volatile program store
- Automatic end-end testing via built-in data modem
- CCITT, CEPT, and Bell compatible

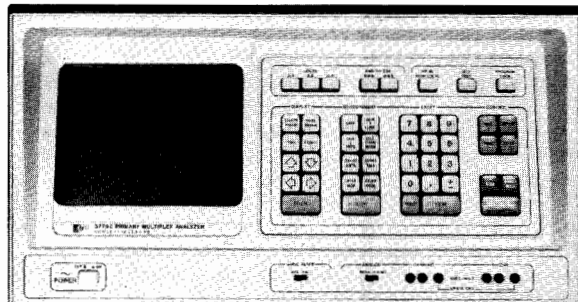

3779C



The 3779C Primary Multiplex Analyzer provides voice channel measurements to CEPT recommendations. The digital option is designed to test PCM equipment conforming to CCITT Recommendations G.711 and G.732, ie 30 voice channels/32 time slots encoded using the A-law and multiplexed into a 2048 kb/s stream. A single channel TTL compatible interface is available for codec and digital line card testing where clock and sync signals are separate from the PCM data.

Model 3779D provides voice channel measurements to Bell recommendations. The digital option is designed to test PCM equipment conforming to BSTR Pub 43801 and CCITT Recommendations G.711 and G.733, ie 24 voice channels/24 time slots encoded using the μ -law and multiplexed into a 1544 kb/s stream. A single channel TTL compatible interface is also available.

Concept

The new 3779C/D Primary Multiplex Analyzer (PMA) is an enhanced version of the 3779A/B. Major improvements, including digital signal generation and filtering, allow the 3779C/D to offer a complete range of faster, more accurate A-A, A-D and D-A measurements, and, in addition, a flexible D-D measurement capability.

The 3779C/D permits rapid, accurate, automatic testing of voice channel and primary level digital equipment, the main applications being in the areas of PCM and FDM terminals, codec, SLIC and other specialised telecommunications IC's or hybrid devices, and digital switching systems, especially line card testing. Separate tests of analog-digital (A-D), digital-analog (D-A), and digital-digital (D-D) performance can be made in addition to overall measurements of analog-analog (A-A) performance of voice channels.

The instrument can automatically sequence through a number of measurements to programmed limits, calculate and output results on an alphanumeric CRT display. All measurement execution software is preprogrammed into the instrument, but test levels, frequencies, limits, etc, may be keyboard-modified if required. Measurements may be assembled into a sequence which is stored in non-volatile memory.

The PMA itself can control a number of 3777A Channel Selectors to provide multi-channel access for voice and signalling measurements. It can also format results and print them out via a suitable printer equipped with HP-IB. A built-in modem allows one PMA to control another over the channel under test, facilitating automatic end-end (E-E) testing of a voice circuit. A new feature in the 3779C/D offers considerable improvements in E-E measuring speed when testing on "wet" lines.

Specifications

The standard 3779C/D provides A-A and E-E measurement capability. A-D, D-A, and D-D capabilities are optional. The A-A, A-D, D-A, and E-E measurements are summarized in Table 1.

Table 1. 3779C/D PMA Measurement Capability

Measurements	A-A	A-D	D-A	E-E
Gain	•	•	•	•
High accuracy gain	•			
Digital mW gain			•	
Gain vs frequency	•	•	•	•
Gain vs level using noise (3779C only)	•	•	•	•
Gain vs level using tone	•	•	•	•
Gain vs level using sync 2 kHz			•	
Coder offset		•		
Peak codes		•		
ICN weighted, 3 kHz flat & selective	•	•	•	•
Noise with tone	•	•	•	•
Quantizing distortion using tone	•	•	•	•
Quantizing distortion using noise (3779C only)	•	•	•	•
Intelligible crosstalk	•	•	•	•
Intermodulation using two tones	•	•	•	•
Intermodulation using four tones (3779D only)	•	•	•	•
Discrimination against out-of-band inputs	•			•
Spurious out-of-band outputs	•			•
Spurious in-band outputs	•		•	•
Return loss using swept tone (Tx & Rx)	•			•
Impedance balance (Tx & Rx)	•			•
Signal balance	•			•
E & M signalling distortion	•			•
Tx/Rx	•	•	•	

In addition, facilities are available on the 3779C to test automatically the muldex alignment and alarm strategy.

New D-D Measurement Mode

Crosstalk measurements of both inter-channel and go-return type can be selected. These allow, for example, evaluation of far-end D-D crosstalk and transhybrid loss/echo return loss.

A Tx/Rx facility allows independent control of digital transmitter and receiver. Thus, most of the measurements listed in Table 1 can be performed either manually or, using an external controller, automatically in the D-D mode.

Options (3779C)

001: provides A-D, D-A, and D-D hardware and software; 2048 kb/s PCM interfaces are ternary rectangular with 75 Ω unbalanced BNC connectors; single channel digital interfaces are serial or parallel, TTL compatible.

002: as Option 001 except PCM and clock connectors are Siemens 1.6/5.6 mm 75 Ω unbalanced.

003: as Option 001 except PCM and co-directional clock connectors are Siemens 3-pin 120 Ω balanced.

Options (3779D)

001: provides A-D, D-A, and D-D hardware and software; 1544 kb/s PCM interfaces are bipolar rectangular with 100 Ω balanced WECO connectors; single channel digital interfaces are serial or parallel, TTL compatible.

002: provides A-D, D-A, and D-D hardware and software for μ -law systems operating at 2048 kb/s; digital connections are via single channel interfaces only, as specified for Option 001.

003: as Option 001 except PCM and clock connectors are BNC 75 Ω unbalanced.

Ordering Information

3779C Primary Multiplex Analyzer (CEPT)

3779D Primary Multiplex Analyzer (Bell)

Prices

Add \$2225.00

Add \$2225.00

Add \$2225.00

Add \$2225.00

Add \$2225.00

Add \$2225.00

\$26690.00

\$26690.00

TELECOMMUNICATIONS TEST EQUIPMENT

HP-IB Controlled Channel Selector; PCM Test Systems

Models 3777A, 3779



- DC to 110 kHz
- 2-wire/4-wire balanced switching
- Modular construction
- Up to 30 4-wire channels

- 3779 multi-measurement capability
- 3779 ease of programming and operation
- Extended operation using the HP-IB
- Wide range of system controllers

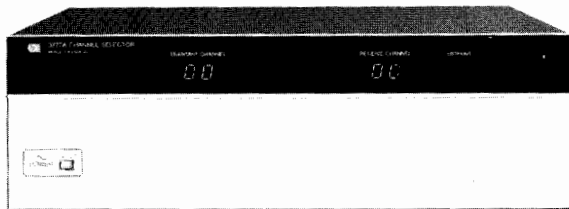

3777A



3777A Channel Selector

The 3777A is an HP-IB controlled Channel Selector. It provides test point access for maintenance and production testing of PCM and FDM telecommunications systems.

The instrument contains two identical banks of relays, termed 'Transmit' and 'Receive.' Each bank comprises up to 30 balanced, bi-directional, two-pole changeover switches. The Transmit bank enables switching of a single source to any one of up to 30 outputs. In the Receive bank, any one of up to 30 inputs can be switched to a common output. To provide a quiet termination for telecommunications equipment, all unselected channels are terminated in 600Ω in series with 2.2μF. Alternative impedances can be provided on request.

The two switch banks are controlled independently via the HP-IB from the 3779 Primary Multiplex Analyzer, a computer or a programmable calculator. For automatic test systems, the 3777A can scan, under external program control, through a number of channels in any desired sequence.

For applications requiring more than 30 channels, several 3777A's can be connected in a switch array. Other configurations can be realized by the appropriate interconnection of the Transmit and Receive bank inputs and outputs.

Construction of the 3777A is modular, with the 30 channels in both Transmit and Receive banks arranged in 5 blocks, each block having 6 Transmit and 6 Receive channels. 12 and 24 channel versions with only 2 or 4 blocks are available as options.

Principal applications are in testing telecommunications equipment where the 3777A may be used to switch PCM primary multiplex channels, FDM voice channels or groups, and voice frequency telegraph circuits, for measurements during production, installation, or maintenance. The high quality relays employed in the 3777A also make it suitable for many other general purpose applications requiring an HP-IB controlled channel selector.

3777A Options

- | | |
|--|------------|
| 001: 24 channels in transmit and receive banks. WECO 310 connectors used for transmit I/P and receive O/P. | less \$295 |
| 002: 12 channels in transmit and receive banks. Siemens audio connectors used for transmit I/P and receive O/P. | less \$865 |
| 003: 12 channels in transmit and receive banks. WECO 310 connectors used for transmit I/P and receive O/P. | less \$865 |

Prices

3777A Channel Selector

\$5005.00

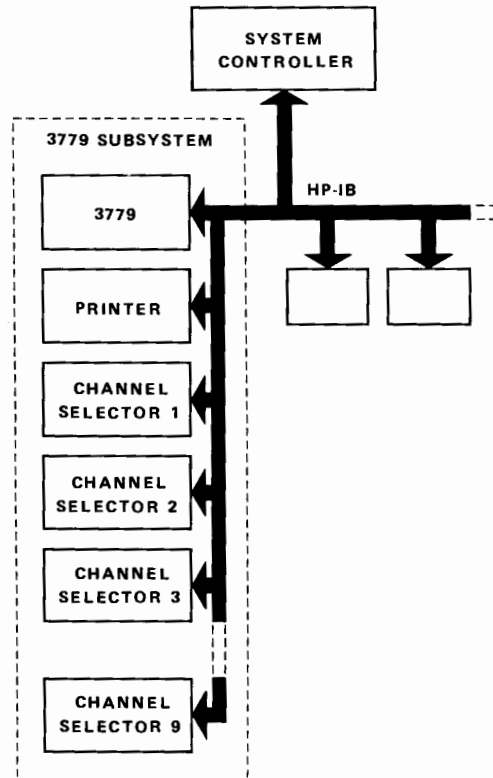

PCM Test Systems

The 3779 Primary Multiplex Analyzer (PMA) is itself a system controller, containing operating software for a system comprising a printer and up to nine 3777A Channel Selectors. However, versatile as the PMA is, some users may require more. The following examples are just a few of the ways in which the PMA capability can be enhanced by using an external system controller.

- A worst-case channel can be identified, and then analyzed in detail. Statistical analysis of results can also be performed.
- For testing different types of terminal equipment consisting of a wide variety of channel cards, the desired measurement sequences can be constructed in the PMA using the instrument's ease of programmability, then transferred into an external controller and recalled as required.
- In processor-controlled switching applications, the switch controller can instruct the PMA to perform a number of measurements on the matrix path.
- Production test stations using PMA's can be controlled from a centralized computer system. This can be used to give increased test throughput of specialized communications devices, eg codecs, SLIC's.
- A PMA subsystem may form part of a larger automatic test system incorporating, for example, power supplies, DVM's, switches, etc.

System Components

- 3779 Primary Multiplex Analyzer
- 3777A Channel Selector
- Printer—must have 80-character field width and 128-character upper and lower case ASCII printing set. Data storage preferable to reduce "waiting time". Recommended Printers include 2631A, 9876A, 2608A.

TELECOMMUNICATIONS TEST EQUIPMENT

30 CH PCM Alignment Monitor and Error Detector

Model 3783A

- Provides in-service error monitoring
- Counts frame or code errors
- Low-cost, portable unit
- Optional rechargeable battery

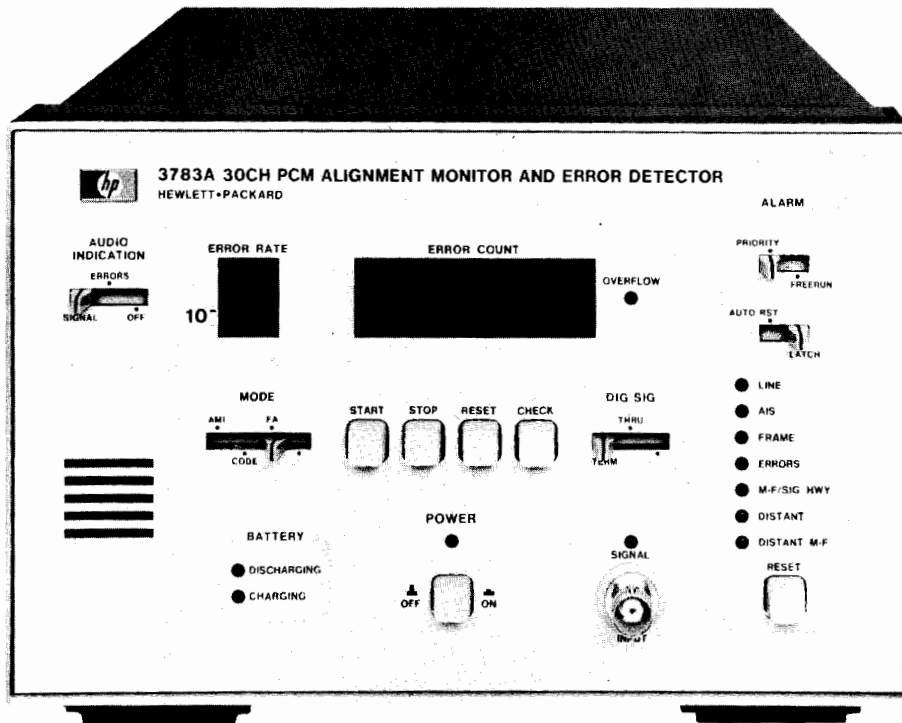

3783A

The 3783A is a low-cost, portable instrument for in-service measurements on 2 Mb/s digital transmission systems conforming to CCITT Recommendation G.732 (European CEPT, 30 channel PCM multiplex standard). The instrument can detect and count:

- Frame alignment signal errors
- Code violation errors
- External input error pulses from a multiplex

Frame alignment signal (FAS) errors are measured by decoding the HDB3 2 Mb/s line signal and recovering the time slot allocated to the framing signal, TS0, from which errors occurring in the FAS can be detected and counted. Display of the measured result can be a binary bit error rate, based on the assumption that the overall signal contains a Poisson distribution of errors, or a FAS error count over a manually selected measurement period. While operating as a FAS error detector, the instrument also detects and displays any system alarm states which are carried in TS0 and TS16, the time slot allocated to signalling. These alarm states can be displayed on a priority or free run basis with a latch/auto-reset facility.

In addition to monitoring FAS errors, the 3783A can check the input line signal for code violation errors according to the AMI or HDB3 encoding rule. The instrument can also count low frequency input pulses such as the error output signal found on some digital transmission equipments.

The 3783A can be attached in terminated mode to the output of an equipment (out-of-service measurement) or in monitor mode to the high impedance monitor point provided on digital transmission equipment (in-service measurement). An optional rechargeable battery pack allows portable field use where normal station ac main supplies are unavailable. An audio indication of signal present or detection of errors can be selected.

Specifications Summary

Signal input: switched digital signal or error count input.

Clock recovery: from the digital signal input at 2048 kb/s \pm 100 b/s.

Signal format: AMI or HDB3 with frame structure conforming to CCITT Recommendation G.732.

Impedance: 75 Ω unbalanced (120 Ω balanced, by special request).

Count input: maximum 4 kHz binary input.

Measurements: code errors, frame alignment errors, and external error count.

Display: error rate exponent and 5 digit error count simultaneously.

Gating: automatic for error rate, manual for error count with start/stop/reset control.

Alarm flags: line, AIS, frame, errors, multi-frame/signalling high-way, distant, distant multi-frame; priority or free run selection with auto-reset or latch plus overall reset facilities.

Audio indication: tone burst for signal or errors present, selectable.

Alarm outputs: two TTL outputs; each goes high when alarm state detected.

Recorder output: current drive proportional to displayed result.

General

Power supply: 115 V + 10% - 22% or 230 V + 10% - 18%, ac, 48 to 66 Hz.

Options

001: operation from rechargeable battery pack.

002: 120 Ω balanced input; 3 pin Siemens connector.

Price
add \$60
N/C

3783A 30 CH PCM Alignment Monitor and Error Detector

\$2170

TELECOMMUNICATIONS TEST EQUIPMENT

1 kb/s/50 Mb/s PCM/TDM Error Measuring Set for Field Use

Model 3780A



- Binary and code error measurements
- Internal crystal clocks and clock recovery
- Clock frequency offset generation and measurement
- Ternary coded and binary interfaces
- PRBS and WORD pattern generation and detection
- Printer and recorder outputs

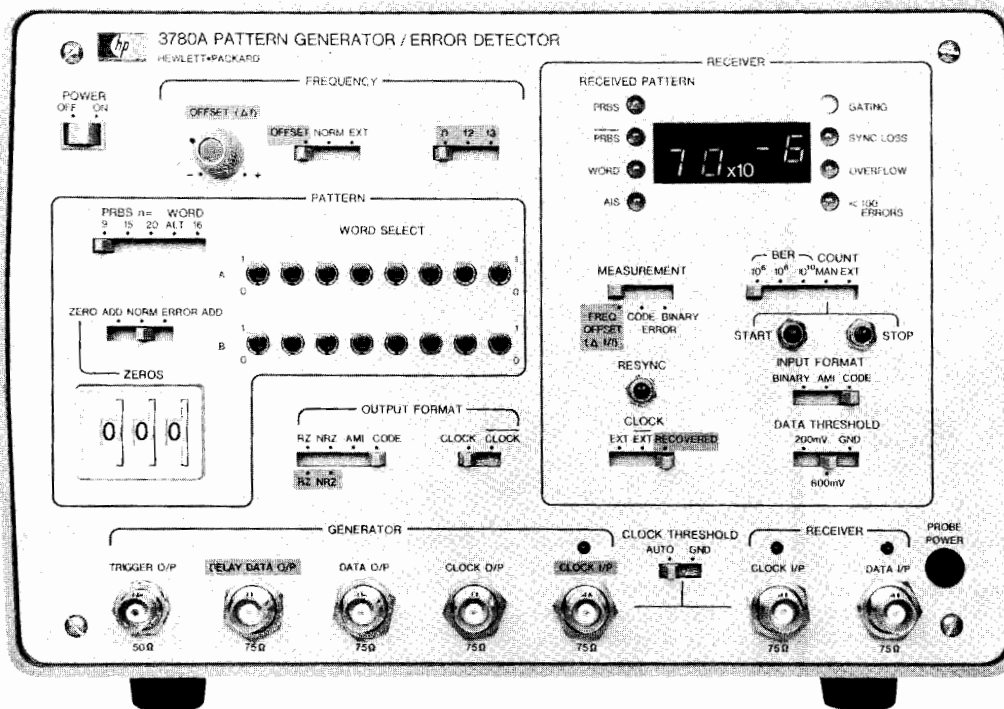

The 3780A Pattern Generator/Error Detector is a comprehensive error measuring set in one portable package. The instrument measures Binary Errors and Code Errors in digital transmission equipment operating at bit rates between 1 kb/s and 50 Mb/s. Frequency offset generation and measurement are also provided at the standard bit rates used in PCM/TDM transmission.

Binary errors are detected by stimulating the system with a test pattern and comparing the output bit-by-bit with a separate internally generated, error-free pattern. Code errors on interface or line coded information are detected during decoding into binary data. The errors can be counted over a chosen gating period and displayed directly as bit error rate (BER) or total error count (COUNT).

Error measurements can be made with PRBS or WORD patterns and the receiver has automatic pattern recognition and synchronization. Alternatively, the reference pattern can be preset by the pattern switch which allows detection of systematic pattern errors. Zero add facilities allow investigation of regenerator clock recovery performance. This capability can be extended by the optional addition of programmable word and alternating word generation.

The clock frequency in the pattern generator can be offset and measured in the receiver. The offset is displayed as a fraction of the nominal crystal centre frequency. In addition, the offset of external clocks applied to the generator can be measured provided that the frequency is within 25 kHz of one of the installed crystal frequencies.

BER or COUNT results can be displayed directly by LED's on the front panel or monitored via a BCD printer and strip chart recorder. This makes the 3780A ideally suited for unattended long-term measurements. Monitoring, display, and recording of the Alarm Indication Signal (AIS) is now included.

The 3780A has been designed principally for use in field trials, commissioning, and maintenance of digital transmission terminal and link equipment. It is particularly suited for testing digital multiplex, radio, and line systems but will also find application in development of more advanced systems such as optical fibre transmission and time division switching.

Specifications

Measurements

Binary errors: closed loop bit-by-bit detection on any pattern produced by generator, excluding added zeros or alternating words.

Code errors: violations of coding rule detected on any pattern with AMI, HDB3, or HDB2 coding (optionally AMI, B6ZS, or B3ZS).

Frequency offset: measurement of fractional offset of generator clock output from installed crystal rates.

Options

Word/Connector Options

	Price
001: all words replaced by a 16-bit front panel programmable word	add \$255
002: Siemens 1.6 mm connectors	add \$85
003: combination of 001 and 002	add \$315

Frequency Offset Option

099: frequency offset capability—measurement only, generation facility deleted	less \$170
---	------------

Frequency/Codec Options

Std: internal clock frequencies of 2048, 8448, and 1536 kHz; HDB3/HDB2 codec.	N/C
100: internal clock frequencies of 2048, 8448, and 34368 kHz; HDB3/HDB2 codec.	add \$255
101: internal clock frequencies of 1544, 6312, and 44736 kHz; B6ZS/B3ZS codec.	N/C
102: internal clock frequencies of 1544, 6312, and 3152 kHz; B6ZS/B3ZS codec.	N/C

3780A Pattern Generator/Error Detector **\$9120**

TELECOMMUNICATIONS TEST EQUIPMENT

CEPT and CCITT Compatible PCM/TDM Error Measuring Set

Models 3781A, 3782A

3781A

- Bit rates of 704, 2048, 8448 and 34368 kb/s
- Standard CCITT test patterns
- Internal jitter modulator

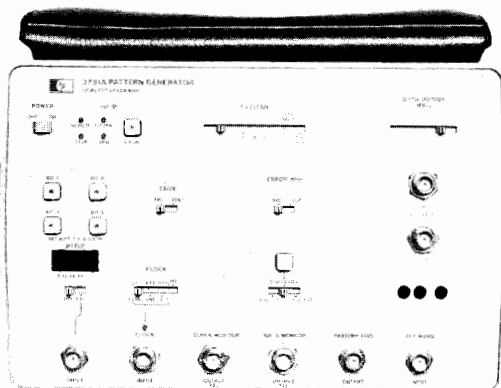

3781A



3782A

- Binary and code error measurements
- Error ratio, error count, error seconds and error-free seconds displayed
- Powerful error distribution analysis

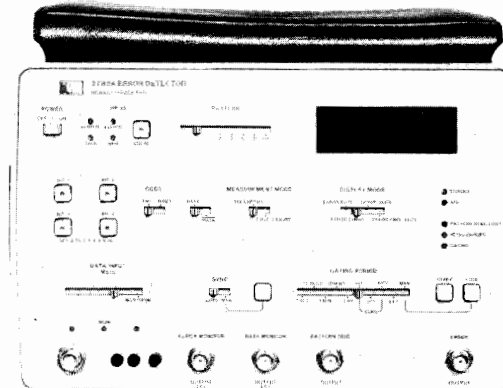

3782A



The 3781A Pattern Generator and 3782A Error Detector form a high performance error measuring system which complements the existing 3780A Pattern Generator/Error Detector. Designed to conform with CEPT and CCITT standards, the 3781A/3782A provide four bit rates (up to 50 Mb/s) of the digital hierarchy in one compact system. Applications of the system are in R&D, field trial and production testing, especially where an automatic and remote measurement capability via the HP-IB is required.

In the 3781A, binary or code errors can be injected as single shot or at 10^{-3} or 10^{-5} rates into a wide range of PRBS and 16-bit WORD test patterns coded in AMI or HDB3. The test patterns provided include standard 2^9-1 , $2^{15}-1$, and $2^{23}-1$ bit PRBS to CCITT Recommendations, fully programmable 16-bit WORD, and two 8-bit WORDS which may be alternated under the control of an external signal. Zero substitution (up to 120 zeros) for PRBS patterns is included to examine, for example, the clock recovery performance of regenerators. 75Ω unbalanced and 120Ω balanced pseudo-ternary outputs and binary TTL monitor outputs are provided. A jitter modulation input facility is provided for simple oscillator connection, with direct LED display of pk-pk bits of jitter. This can be used to measure the input jitter tolerance of digital transmission equipment. A second data output with 12 bits delay provides adequate simulation of an independent sequence for thorough testing of 4ϕ PSK digital radio systems. As an option, four extra data outputs coded in AMI or HDB3 can be included on the rear panel for driving adjacent radio channels.

The 3782A detects binary or code errors which can be displayed in the form of error ratio, error count, error seconds, and error-free seconds over a wide choice of gating periods. All four results are computed simultaneously over the same gating period. For ease of use there is a built-in automatic check for compatibility of switch position combinations. An error code flashes on the display if incompatibility is detected. When the monitor mode is used, the 3782A can be used for in-service monitoring of digital transmission links.

Measurement results are available on the HP-IB and a rear panel result threshold switch allows pre-selection of an error threshold above which results will be printed. This provides useful data reduction and a first order error distribution analysis. With a built-in real-time clock, results can be output with time, if required.

Specification Summary

3781A Pattern Generator

Data outputs: RZ HDB3 or AMI on internal clocks, NRZ available by internal links.

Internal clock: four crystal clocks at 704, 2048, 8448 and 34368 kHz.

External clock: 1 kHz to 50 MHz.

Patterns

PRBS: 2^9-1 , $2^{15}-1$, and $2^{23}-1$ to CCITT Recommendations.

WORD: 16-bit WORD (serial combination of 4-bit WORDS A, B, C and D; contents of A, B, C and D can be set by pushbuttons), ALT WORD (8-bit WORD AB may be alternated with 8-bit WORD CD under control of externally applied signal), 1111/AIS (Alarm Indication Signal).

Jitter modulation: timing jitter can be added to the clock and data output signals by applying an external modulating source.

3782A Error Detector

Measurements: binary errors (closed loop bit-by-bit detection at binary level) and code errors.

Display modes: error ratio, error count, error seconds, error-free seconds, error codes, real-time clock.

Options

Prices

3781A

001: adds four 1V pk-pk HDB3/AMI outputs (BNC connectors) to rear panel. add \$520

002: as standard but with Siemens 75Ω connectors in place of BNC connectors on selected ports. N/C

061: rack mounted. add \$118

062: rack mounted with Opt 001 outputs accessed from front panel. add \$250

3782A

002: as standard but with Siemens 75Ω connectors in place of BNC connectors on selected ports. N/C

061: rack mounted. add \$118

062: rack mounted with front panel access to rear panel controls/connectors. add \$320

3781A/3782A

In-ld operating instructions: English-std; German—Option **031**; French—Option **032**; Italian—Option **033**; Spanish—Option **034**. N/C

Ordering Information

3781A Pattern Generator \$8785
3782A Error Detector \$7895



TELECOMMUNICATIONS TEST EQUIPMENT

Bell Compatible PCM/TDM Error Measuring Set

Models 3781B, 3782B



3781B

- DS-1, DS-1C, DS-2, & DS-3 all in one compact system
- Jitter modulation input facility
- Second DS-3 output with 22 bits delay

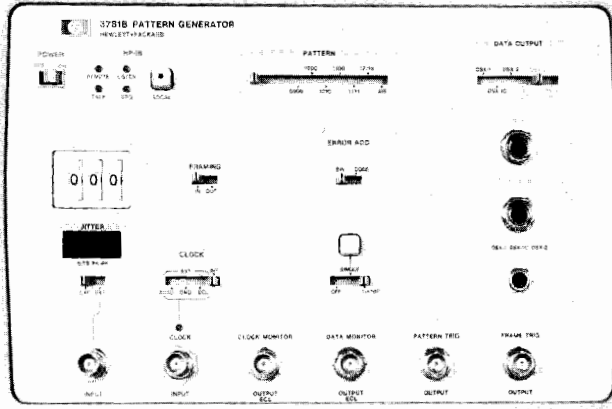

3781B



3782B

- Binary, code, and parity error measurements
- Error rate, error count, error secs, and error free secs displayed
- Preselectable error rate threshold for printing of results

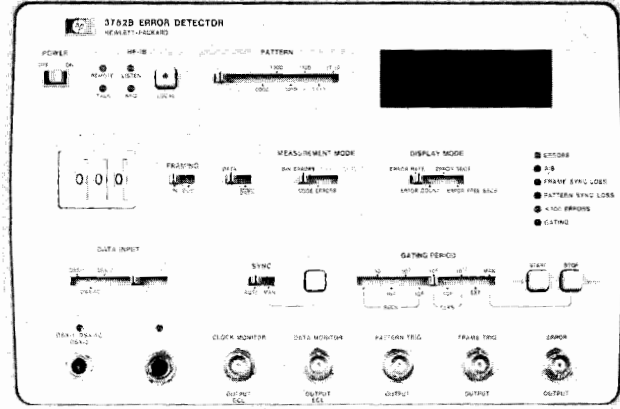

3782B



The 3781B Pattern Generator and 3782B Error Detector form a dedicated error measurement system for testing and evaluating the performance of Bell digital transmission terminal and link equipment, up to and including the DS-3 level in the digital hierarchy. The 3781B/3782B can be used in production testing, field installation, and maintenance of the Bell digital transmission system, including PCM/TDM transmission over cable, radio, satellite, and fibre optic links. The principal application is at the DS-3 level in the Bell digital hierarchy.

The 3781B/3782B are designed to Bell standards with automatic selection of the appropriate framing structure, ternary coding, and interface voltage levels at each hierarchical level. At the DS-3 level, a choice of four data formats is available. Alternatively, binary ECL interfaces can be used.

The 3781B Pattern Generator provides a selection of standard $2^9 - 1$, $2^{15} - 1$, and $2^{20} - 1$ bit PRBS and fixed WORD test patterns with a choice of single error or 1 in 10^5 error simulation on the digital data stream for normal measurements and troubleshooting. A pattern of 17 ones/15 zeros and zero substitution (up to 999 zeros) for PRBS patterns are included to examine phase sensitive circuitry such as clock recovery of regenerators. A jitter modulation input facility is provided for simple oscillator connection, with direct LED display of pk-pk bits of jitter. This can be used to measure the input jitter tolerance of digital transmission equipment. A second DS-3 output channel with 22 bits delay provides adequate simulation of an independent sequence for thorough testing of 4ϕ PSK digital radio systems. As an optional extra, four DSX-3 BNC outputs on the rear panel can be included for driving adjacent radio channels.

The 3782B Error Detector detects any binary or code errors generated by the system under test. At the DS-3 level, it can perform in-service or out-of-service measurements of parity errors within the digital transmission system. The 3782B can measure simultaneously error rate, error count, error seconds, and error free seconds over a single gating period. When the DS-3 MON facility is used, in-service measurements (eg parity errors) of live traffic are possible. For ease of use, there is a built-in automatic check for compatibility of switch position combinations. An error code flashes on the display if incompatibility is detected. Hard copies of results can be obtained on a printer via HP-IB control, either in the "talk-only" or "addressable" modes. In addition, a preselectable error rate threshold and a real time clock allows selection for printing results which exceed a defined threshold (with local time, if required).

Specifications Summary

3781B Pattern Generator

Data Outputs: DSX-1, DSX-1C, DSX-2, and DS-3 compatible ternary outputs, and ECL compatible binary outputs.

Internal Clock: four crystal controlled clocks at 1.544 MHz (DS-1), 3.152 MHz (DS-1C), 6.312 MHz (DS-2), and 44.736 MHz (DS-3).

External Clock: 1 kHz to 50 MHz.

Patterns

PRBS: $2^9 - 1$, $2^{15} - 1$, $2^{20} - 1$.

WORD: 0000,1000, 1010, 1100, 1111; 17/15 (17 ones/15 zeros);

AIS (alarm indication signal — all ones without framing bits).

Jitter Modulation: timing jitter can be added to the clock and data output signals by applying an external modulating source.

3782B Error Detector

Measurements: binary errors (closed loop bit-by-bit detection at binary level), code errors, and parity errors.

Display Modes: error rate, error count, error seconds, error free seconds, error codes, real-time clock.

Options

3781B

001: adds four additional in-phase DSX-3 BNC outputs to rear panel; front panel DS-3 output connector changed from WECO 440A to BNC. +\$450

061: rack mounted. +\$110

062: rack mount allowing Option 001 outputs to be accessed from front panel. +\$340

3782B

001: DS-3 Data Input connector changed from WECO type 440A to BNC. N/C

061: rack mounted. +\$110

062: rack mount allowing front panel access to Binary/Ternary Input and Real-Time Clock switches, Binary Data and Clock Inputs, and External Gating. +\$250

Ordering Information

3781B Pattern Generator

3782B Error Detector

Price

\$7340

\$6895

TELECOMMUNICATIONS TEST EQUIPMENT

Dedicated PCM/TDM Jitter Generator and Receiver

Models 3785A, 3785B

- Jitter generation and measurement on data and clock
- Jitter specifications designed to CCITT Recommendation 0.171
- Transient-free sweeping of internal CCITT defined jitter tolerance masks

- Single portable unit for up to 4 internal bit rates
- Built-in measurement filters to CCITT Recommendations
- Comprehensive jitter analysis against real-time and jitter amplitude

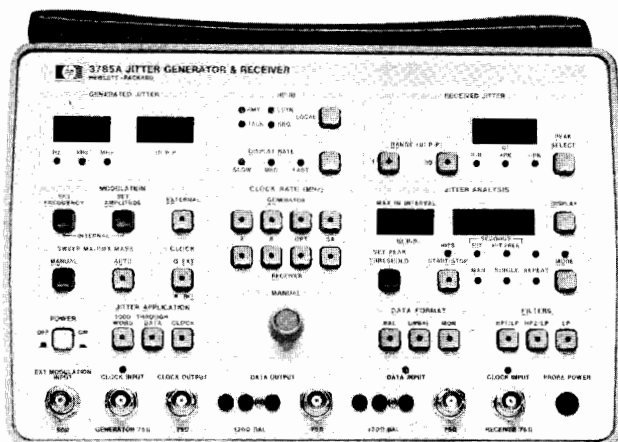

3785A (2048, 8448, 34368 and, optionally, 25776 kHz)
CEPT

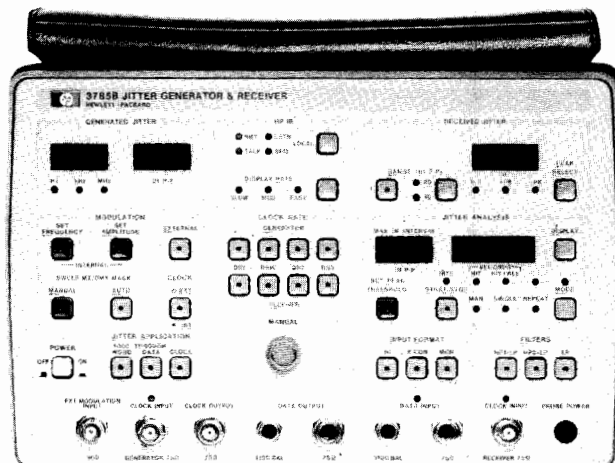

3785B (DS-1, DS-1C, DS-2 and DS-3)
Bell



The 3785A/B Jitter Generator and Receiver is a dedicated jitter measurement system for testing and evaluating the performance of CEPT or Bell digital transmission terminal and link equipment up to and including the third level (34368 kb/s or DS-3) in the digital hierarchy. The 3785A/B can be used in production testing, field installation and maintenance of the CEPT or Bell digital transmission system including PCM/TDM transmission over cable, radio, satellite, and fiber optic links. The principle application is thorough testing to current CCITT Recommendations at each level in the digital hierarchy.

In addition to providing a comprehensive measurement capability which includes in-service jitter measurements, the microprocessor-controlled Jitter Generator and Receiver is easy to use with ergonomic layout of switches and connectors on the front panel. The instrument is designed to interface fully with the HP-IB, allowing bus-controlled operation and automatic measurement sequencing.

The Jitter Generator may be used to phase modulate an internally provided crystal clock, an externally applied clock (at a nominal digital hierarchy bit rate) or an externally applied data stream. Sinusoidal modulation is provided by an internal synthesizer whose amplitude and frequency can be set manually or swept, transient-free, through a shaped mask (proposed by CCITT) programmed into the instrument. Alternatively, external modulating signals can be applied. The amplitude of generated jitter in unit intervals (U.I.) pk-pk and the frequency of internal modulation are in accordance with CCITT Recommendation 0.171 and are displayed on the front panel.

The modulated clock output can be applied to an external pattern generator such as the 3780A, 3762A, 3781A or 3782B. For jitter transfer function measurements, the CCITT standard 1000 repetitive pattern is provided within the 3785A/B. In addition, for demultiplexer jitter transfer function, jitter can be applied to an externally applied data stream which has the necessary framing and justification digits.

Measurements

The Jitter Receiver offers six types of measurement:

- Absolute jitter amplitude in U.I. pk-pk
- Jitter peak, positive or negative
- Jitter hit count of the number of times received jitter exceeds a user-defined hit threshold in U.I. pk

- Jitter hit seconds count of the number of seconds in which one or more jitter hits occur
- Jitter hit-free seconds count of the number of seconds which are free of jitter hits
- Maximum absolute jitter amplitude in U.I. pk-pk is held during the jitter analysis gating period

Simultaneous measurement of all six parameters is possible with result display selection. In addition, the Receiver has a built-in interval timer and real-time clock to allow measurements of jitter distribution against time to be made.

The measurements can be made on clock or data inputs with or without internal filtering. Two high pass filters and one low pass filter as specified by CCITT are provided for each of the four bit rates. In addition, external filters can be connected between the demodulated jitter output and the measuring circuitry input. The demodulated jitter output can also be used to measure rms jitter amplitude on an external voltmeter or to display jitter spectrum on an external analyzer.

The clock reference for the jitter measurements can be internally derived from the applied data or clock via a narrow band phase-locked loop or externally derived from an applied reference.

The data input allows out-of-service or in-service measurements. The MON facility for in-service measurements has built-in additional gain to compensate for the flat loss at the monitor points.

HP-IB Operation

The capabilities of the 3785A/B can be enhanced by using the HP-IB to provide remote operation and automatic sequencing of results.

The HP-IB facility offers several principal features:

- Remote control of front panel switches and pushbuttons using programming codes
- Control codes which are set to default values on power-on and can be user-defined with the controller
- The ability to transfer all desired switch positions and masks onto a tape memory and reloaded back onto the instrument at a later time
- Output of the result data to a printer (eg 5150A Thermal Printer) or tape memory (eg 9875A Cartridge Tape Unit)

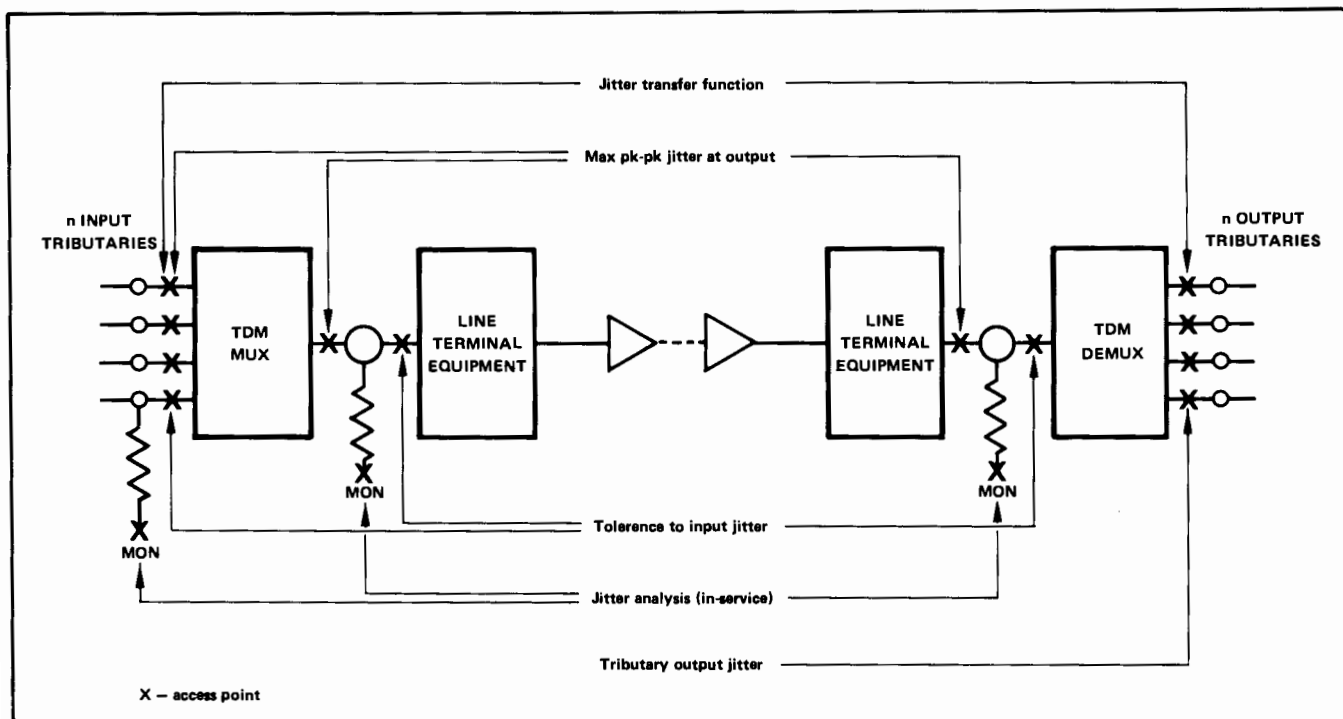

Typical access points for 3785A/B measurements on PCM/TDM digital system hierarchy

Specifications Summary

Jitter Generator

Data outputs

3785A: CCITT Rec G.703 interfaces for CEPT rates.

3785B: DSX-1, DSX-1C, DSX-2 and DSX-3 ternary outputs.

Internal clock: crystal controlled clocks at

3785A: 2.048, 8.448, and 34.368 MHz.

3785B: 1.544, 3.152, 6.312, and 44.736 MHz.

External clock: at internal rates $\pm 10\%$.

Internal jitter modulation: conforms to CCITT Rec. 0.171 (lower frequency limit 1 Hz) (DS-3 only up to 1.12 MHz upper frequency).

External jitter modulation: conforms to CCITT Rec. 0.171 (lower frequency limit dc) (DS-3 only up to 1.12 MHz upper frequency).

Internal jitter tolerance masks: conforms to the appropriate CCITT G. series Recommendations.

Accuracy of jitter display:

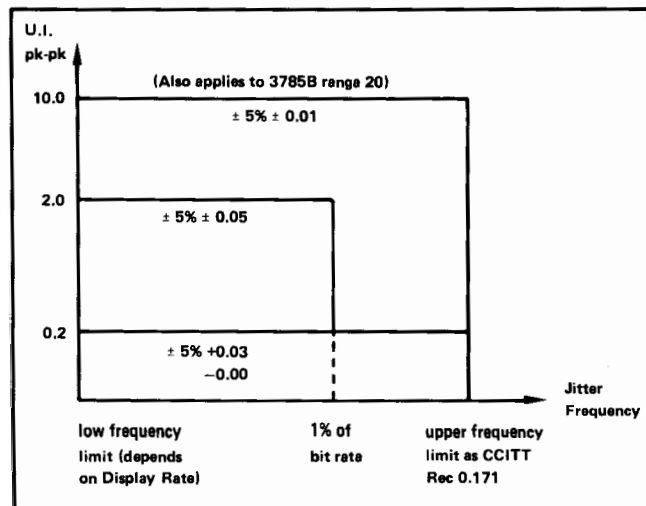

Jitter Receiver

Data inputs: conforms to CCITT Rec. G.703.

3785A: for use at monitor points -30 dB (2.048 and 8.448 MHz) and -26 dB (34.368 MHz).

3785B: compatible with HI outputs and monitor points at DS-1, DS-1C, and DS-3, and HI outputs at DS-2.

Clock input: at internal rates ± 50 ppm or 2.0 to 34 MHz (3785A)/1.5 to 45 MHz (3785B) using Receiver External Reference Clock Input (rear panel).

Jitter amplitude measurement (pk-pk)

Ranges: 1, 10 (and 20, 3785B only).

Max. Jitter amplitude reduced at 6 dB/octave above a nominal corner frequency specified by CCITT Rec. 0.171.

Bandwidth: satisfies CCITT Rec. 0.171 (DS-3 upper frequency limit 1.12 MHz).

Accuracy: $\pm 4\%$ + additional intrinsic error.

Measurements: jitter amplitude pk-pk, jitter amplitude +pk or -pk, jitter analysis. When used in conjunction with a pattern generator and error detector, jitter tolerance and jitter transfer function measurements can be made.

Options

3785A

001: fourth internal clock (25.776 MHz) in addition to the three standard clocks.

002: Siemens connectors on all front panel interfaces.

061: rack mounted.

062: rack mounted with front panel access to rear panel controls/connectors.

3785B

061: rack mounted.

062: rack mounted with front panel access to rear panel controls/connectors.

Prices

Add \$560

N/C

Add \$118

Add \$340

Add \$118

Add \$340

Ordering Information

3785A Jitter Generator and Receiver (CEPT)

\$13065

3785B Jitter Generator and Receiver (Bell)

\$14455

TELECOMMUNICATIONS TEST EQUIPMENT

Dedicated 150 Mb/s PCM/TDM Error Detection System:

Models 3762A & 3763A

- Crystal clocks and clock recovery
- Frequency offset facilities
- Burst mode operation
- Binary and interface codes
- Input equalization
- Error detection on PRBS + Zeros

3762A

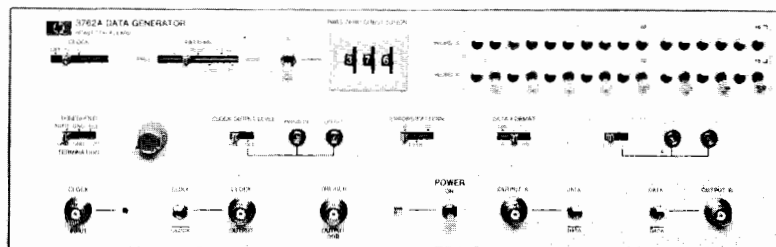

3763A

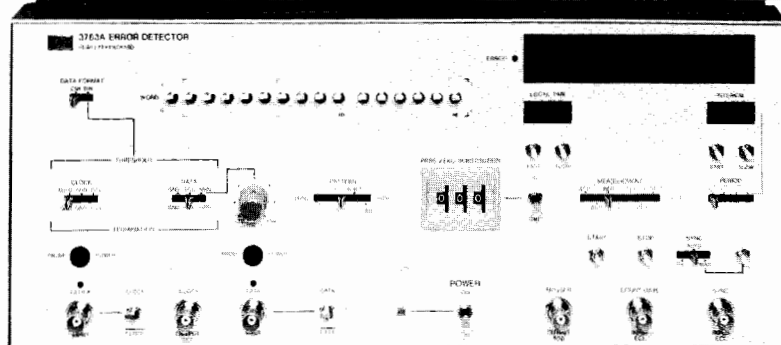

The 3762A Data Generator and 3763A Error Detector comprise a dedicated error rate measurement system for evaluating high-speed digital transmission equipment. Basically, there are two versions of the system available. One features CMI and binary data formats and is specifically intended for use in field commissioning and maintenance of digital radio (terrestrial microwave, and TDMA satellite) systems. The other version, with CMI and ternary (HDB3 and B3ZS) data formats, is designed for digital multiplex and digital cable systems. Although optical fiber systems are still undefined, the 3762A and 3763A have sufficient built-in capability and flexibility to cover applications in this rapidly developing area of telecommunications. Burst gating inputs allow the 3762A/3763A to be used in TDMA applications.

Specifications Summary

3762A Data Generator

Internal clock: two crystal clocks in the range 30 to 150 MHz; crystals fitted in standard unit are 139.264 and 141.040 MHz; offset continuously variable up to ± 60 ppm.

External clock input: 1 kHz to 150 MHz; 75 Ω .

Patterns: $2^{10} - 1$, $2^{15} - 1$, and $2^{23} - 1$ PRBS; two 10- or 16-bit programmable words; two 1010...repetitive patterns; two 8-bit words alternated by an external signal; PRBS patterns can be gated off for 1 to 999 clock periods after trigger pulse (zero substitution); error add facilities.

Data output A: PRBS or WORD A; DATA or $\overline{\text{DATA}}$, in CMI, NRZ or RZ format; 75 Ω .

Data output B: PRBS delayed, or WORD B, in NRZ or RZ format.

3763A Error Detector

Data input: CMI, NRZ, or RZ formats; 75 Ω DATA or $\overline{\text{DATA}}$; 12 dB fixed equalization at 70 MHz on CMI inputs with clock recovery.

External clock: as 3762A.

Patterns: all the patterns of the 3762A, including zero substitution, but excluding alternating words.

Synchronization: automatic, manual, or external (ECL).

Error measurements: closed loop bit-by-bit comparison at the binary level with an independent, error-free local reference.

BER: looks for 10 or 100 errors and takes reciprocal of clock counter; result displayed as $X.Y \times 10^{-n}$ where $n = 1$ to 9, with automatic scaling.

COUNT: totalizes errors over a selected gating period; internal period can be 10^6 , 10^8 , 10^{10} clock periods or 1 min to 24 h, repetitive or single shot, manual start/stop or external (ECL) control; result displayed as ABCD.

Measurement gating input: gates error and clock inputs to error counter, providing a measurement "window"; 50 Ω ; ECL levels.

Frequency offset measurement: measures deviation of received bit rate from nominal rate; result displayed as $\pm \text{BCD} \times 10^{-6}$.

Printer output (rear panel): 8-4-2-1 BCD, 10-column output of result, plus local time, if required, and flags; TTL print command pulse.

Recorder output (rear panel): constant current drive output of BER or COUNT result, with flags.

Options (3762A; 3763A)

105: 75 Ω interfaces changed to 50 Ω . Frequencies are 60.032 and 30.016 MHz.

201: Data output B not delayed; HDB3/B3ZS/AMI; 75 Ω ; ± 1 V. Second data input (B) on 3763A; 75 Ω ; HDB3/B3ZS/AMI; automatic equalization for up to 12 dB cable loss at $\frac{1}{2}$ bit rate relative to a ± 1 V signal; clock recovery at installed crystal frequencies. Channel B cannot be used simultaneously with A. Frequencies are 139.264 and 120.000 MHz.

202: as for Option 201 except frequencies are 139.264 and 34.368 MHz.

330: as for Option 201 except frequencies are 137.088 and 44.736 MHz. In addition, clock and binary data interfaces changed to 50 Ω .

801: front cover.

Prices

N/C

N/C; +\$420

N/C; +\$350

N/C; +\$370

\$38; +\$48

Ordering Information

3762A Data Generator

\$10,565

3763A Error Detector

\$10,785

TELECOMMUNICATIONS TEST EQUIPMENT

PCM/TDM Accessories



Models 15506A, 15507A, 15508B, 15508C, 15509A, 15509B, 15510A, 15511A, 15512A, 15513A, 15514A, 15515B



15506A



15509A

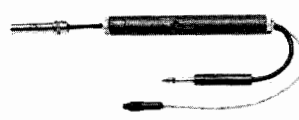

15509B

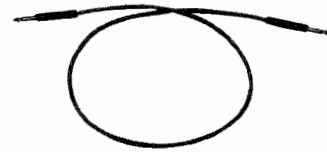

15513A

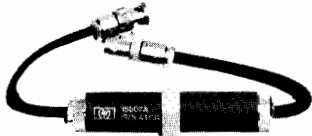

15507A



15510A

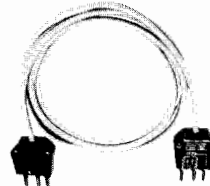

15511A

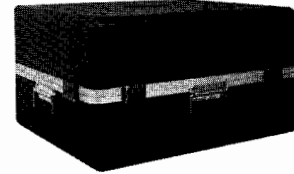

15514A



15508B



15508C

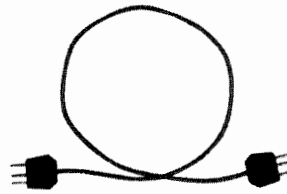

15512A

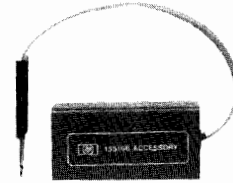

15515B

15506A Frame Alignment Generator

The 15506A provides a 2048 kb/s PCM signal, complete with framing structure, coded in AMI or HDB3 via a 75Ω unbal or 120Ω bal output. It can be used for checking the operation of the 3783A 30 Ch PCM Alignment Monitor and Error Detector.

15507A Isolator

This unit provides isolation from longitudinal voltages which may appear on test connections to digital transmission equipment. It can also be used when the ground potential of the test equipment is different from that of the transmission equipment.

15508B Converter (75Ω unbal—110Ω bal)

This unit provides a nominal 110Ω balanced interface conversion from 75Ω unbalanced interfaces on digital test equipment. This is required at the 1544 kb/s DS-1, 3152 kb/s DS-1C, and 6312 kb/s DS-2 levels of North American digital transmission systems.

15508C Converter (75Ω unbal—120Ω bal)

The 15508C provides a nominal 120Ω balanced interface conversion from 75Ω unbalanced interfaces on digital test equipment. This may be required at the 2048 kb/s primary multiplex levels of European digital transmission systems.

15509A Amplifier

This unit is designed to provide sufficient gain on a digital signal appearing at a standard digital equipment protected monitor point to trigger the Error Detector input. This is required to monitor in-service systems for code violations. Power for the 15509A is supplied from the 3780A front panel PROBE POWER socket.

15509B Amplifier

The 15509B is similar to the 15509A except that it is intended for operation at the DSX-1, DSX-1C, and DSX-2 monitor points of North American digital transmission systems.

15510A 75Ω Cable Accessory

The 15510A is designed to provide a protected monitor point to the 15509A input. This allows the Error Detector to monitor in-service

systems (75Ω) for code violations when the system monitor point is unprotected.

15511A 120Ω Cable Accessory

The 15511A is designed to provide a protected monitor point to the 15508C input and, subsequently, the 15509A input. This allows the Error Detector to monitor in-service systems (120Ω) for code violations when the system monitor point is unprotected.

15512A Cable

The 15512A is a 1 m length of 600Ω balanced cable with a 3-pin audio connector (Siemens type) at each end.

15513A Cable

The 15513A is a 1 m length of 600Ω balanced cable with a WECO 310 jack plug at each end.

15514A Transit Case

The 15514A is a transit case with moulded foam inserts for transporting the 3779 Primary Multiplex Analyzer.

15515B Loop Holding Unit

Model 15515B is a loop holding unit which provides 24mA loop holding current sinking. It is supplied with WECO connectors.

Ordering Information

	Price
15506A Frame Alignment Generator	\$385
15507A Isolator	\$250
15508B Converter (75Ω unbal—110Ω bal)	\$208
15508C Converter (75Ω unbal—120Ω bal)	\$190
15509A Amplifier	\$330
15509B Amplifier	\$280
15510A 75Ω Cable Accessory	\$84
15511A 120Ω Cable Accessory	\$158
15512A Cable	\$75
15513A Cable	\$60
15514A Transit Case	\$775
15515B Loop Holding Unit	\$310

TELECOMMUNICATIONS TEST EQUIPMENT

General Information: Data and Voice Testing

Data and Voice Testing

There are a wide variety of tests which can be made on a data communications system. Depending on the point in the system at which the tests are made, quite different philosophies and techniques apply. These group conveniently into three areas; protocol, digital and analog testing (Fig. 1). Protocol testing is concerned with the control sequences that establish the datacom link. Digital testing evaluates the accuracy of the data transmission. Analog testing measures the characteristics of the transmission line such as loss and noise.

Data communications troubleshooting involves some unique testing problems that are different from the testing done on traditional

in with different parameters. This constant change requires more frequent testing.

Protocol Testing

A new serial analyzer, the HP 1640B, captures and displays the serial data at the RS-232-C (V.24) interface. Data is displayed in binary form using hexadecimal notation, or in the actual high level code being transmitted, such as ASCII or EBCDIC. In addition, the analyzer makes time interval measurements between events occurring at the interface. The 1640B can trap on invalid character sequences, time interval violations, or data errors, enabling the user to identify problems quickly when troubleshooting a computer communications network.

the modem's ability to overcome them. Modems vary widely in their sensitivity to line impairments. Low speed (less than 300 bps) and adaptively equalized modems are less sensitive than high speed (more than 4800 bps) and nonadaptively equalized modems.

Since data communications systems transmit data and control errors in blocks, these instruments also measure Block Error Rate. Bit Error Rate and Block Error Rate can be used together to examine the statistics of the error mechanism. If the Bit Error Rate and Block Error Rate are both high, the impairment is random and probably due to noise. If the Bit Error Rate is high but the Block Error Rate is low, the impairment is more sporadic. This happens when lines are switched, sync is temporarily lost or impulse noise is too high.

Error rates are qualitative checks of the data communication system which can be made in a few minutes. If the system is bad, diagnostic measurements are provided to help isolate the problem. Dropouts, clock slips, error skew, jitter and total peak distortion indicate some of the problems that can occur on a link. These measurements are made simultaneously with the error rate measurements and can be printed out in automatic, unattended mode if desired.

Catastrophic failures can usually be found with self tests and loop back switches built into the Data Terminal Equipment and Modem. A Transmission Test Set can find catastrophic failures of the transmission line. Logic Analyzers and Data Error Analyzers can find catastrophic failures that are not illuminated by internal self tests.

Degradations of the modem or transmission line are more difficult to find and require more extensive test equipment. The most common degradation is an excessive error rate due to line impairments or a faulty modem.

The transmission line will have a set of steady state impairments (e.g., amplitude distortion, envelope delay distortion, non-linear distortion, and frequency offset which smear the modem's symbols and make them harder to separate in the modem receiver). The line will also have random impairments (e.g., message circuit noise, impulse noise, phase jitter, phase and gain hits which can temporarily push the symbols into the wrong slot, causing a digital error).

Analog Line Impairments

Transmission Line Analyzers and Transmission Impairment Measuring Sets (TIMS) are used to measure the transmission distortion parameters which can cause the modems to have a high error rate. These instruments make measurements on the analog telephone line and therefore provide direct information of whether the line meets its specified parameters. These impairments fall into two main types: steady state and transient. In most cases the transmission parameter measurements conform to CCITT or Bell Standards both in the methods used and results obtained.

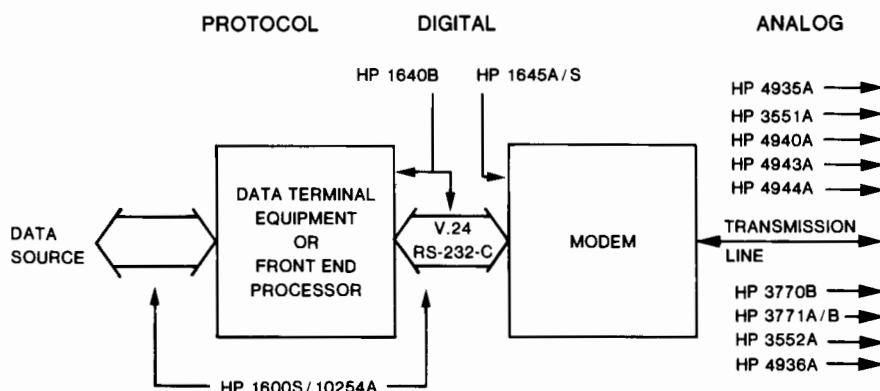

Figure 1. The three domains of data communication instrumentation.

equipment. The individual tests and parameters are simple because of the low bandwidths (about 3 kHz) and modest signal-to-noise ratios (about 24 dB). The difficulty comes from the complex interrelationships of these simple parameters. For example, how does envelope delay distortion of the line (Figure 2) affect the digital error rate of a modem (Figure 3), and how does that affect the throughput of the computing system? The mathematical relationship between these simple parameters is very difficult to understand for terrestrial data links. Generally, specific limits for each parameter are tariffed for different classes of channel service.

Data communication systems require extensive handshaking between machines and across the different domains. Handshake problems are difficult to locate because they are transient and because each machine alone usually will test good. It is very difficult to isolate the handshake problem to one interface.

The geographic size and multitude of subsystems in a telecommunication system make it vulnerable to intermittent and transient impairments as well as degradation and change with time. Intermittent problems are very difficult and time consuming to troubleshoot in any system. The size and complexity of a data communication system aggravates the problems.

Even private leased lines are in a constant state of flux. When a trunk goes down for testing or repair, a new trunk will be patched

The 1640B is also capable of simulating a computer, terminal, or the digital side of a modem by generating specific messages and interface handshake signals, a capability useful not only during network troubleshooting but also for developing and debugging systems software during systems integration and installation phases.

The HP 1600S Logic State Analyzer, when combined with the 10254A Serial-to-parallel Converter, extends HP's 1600S capability to the serial buses within the CPU or terminal. Comparative analysis can be made across I/O interfaces to verify performance of serial formatters for terminals and disc drives. The 1600S/10254A system operates to 10 MHz and displays data in its natural binary format. Its application is intended primarily for synchronous interfaces or asynchronous interfaces where a bit clock is available.

Digital Measurements

Data Error Analyzers are used to monitor the quality of both the modem and transmission facility. They provide more information about the modem and transmission line than Logic State Analyzers, but no information about the Data Terminal Equipment which they replace.

The overall quality of the link is indicated by its Bit Error Rate. A good link will have an error rate better than 1×10^{-5} errors per bit. This measurement will include the effect of both transmission line impairments and



Typically a leased telephone line is conditioned to suit it to the type of service that it is going to carry. There are three parameters which must be considered if reliable transmission is to be achieved:

- (a) effective channel bandwidth as given by the attenuation and delay distortion.
- (b) net circuit loss.
- (c) noise.

The attenuation and delay distortions impose an upper limit to data transmission speed and reduce the noise margin to errors generated. Noise includes both steady-state background noise and transient noise which includes impulse noise, gain and phase hits and dropouts.

Measurements

Data transmission at speeds below 2400 bps is usually achieved using asynchronous modems employing frequency shift keyed or FSK modulation. These modems are not as sensitive to line impairments as high speed modems and most maintenance requirements may be satisfied with basic test equipment such as the 4935A/4936A or the 3551A/3552A transmission test sets. Digital test measurements may be made using the 1645S Data Error Analyzer which is designed for asynchronous and synchronous testing.

At transmission rates of 2400 bps and above it is necessary to reduce the bandwidth of the transmitted signal so that it may be carried within the 300 Hz to 3.4 kHz bandwidth of the telephone channel. This is accomplished using synchronous modems which code several data bits in each transmitted symbol. These modems are more sensitive to line impairments than low speed modems and consequently it is desirable to control line quality to more tightly specified limits.

High speed data modems working at 4800 bps and above generally include adjustable filters called equalizers which are used to modify the frequency and phase response of the telephone circuit so that optimum performance may be obtained. Often these equalizers are designed as transversal filters which are automatically adjusted by the modem receiver so that slowly varying line parameters may be compensated for, without requiring frequent operator intervention. Auto-equalized modems are often more sensitive to transient line impairments which can cause the modem to lose synchronization, consequently, for example, a short dropout lasting only a few milliseconds may cause a loss of data for several seconds or even minutes.

The 4940A Transmission Impairment Measuring Set is capable of measuring all of the tariffed parameters in the U.S. The 4943A/4944A measure the parameters needed for circuit routing and installation testing to the standards required by Bell PUB 41009. For measurements to European standards the 3770B measures all of the maintenance parameters laid down in CCITT recommendation M.1060. This includes amplitude and group delay distortion to CCITT rec. 0.81, noise to P.53 and impulse noise to 0.71. The 3771A/B is designed

for making troubleshooting measurements on high speed band transmission systems. The 3771A/B measures loss, noise, phase jitter, frequency shift and the transient impairments, phase hits, gain hits, dropouts and three levels of impulse noise. The 3771A makes measurements to CCITT standards, the 3771B to Bell Standards. There is some degree of overlap in the analog measurements. A 4935A or 4936A might be used to make level and noise measurements on a high speed circuit and a 4940A may be required to investigate difficult problems on a low speed asynchronous circuit.

There usually must be an "identical" or equivalent test set at each end of the line e.g. 4940A/4940A or 3770B/3770B and a technician to operate the set in each direction. The 3770B and 4943A/4944A may each be used in master/slave configuration so that the measurement may be controlled, and results obtained, at one end of the link. This simplifies test procedures and often results in more reliable measurements.

Sometimes lines can be looped around at the far end to eliminate the need for an extra technician and test set. This is ideal for half duplex testing of experimental equipment in the laboratory. In the field the loop around results in testing a tandem line of twice the normal length. Some measurements obtained in this way are not valid because the impairment on the two halves of the circuit are likely to cancel for example: frequency shift and phase jitter. Other measurements will show whether the parameters of the circuit have become degraded but the results are comparative, not absolute and cannot be used for tariffing. System fault finding is generally done by performing Bit Error Rate measurements both end to end and in loop around and some modems are capable of gain restoration in analog loopback to avoid the unrealistic 16 dB loss.

Only the Serial Data Analyzer is capable of on-line testing with data traffic. The Data Error Analyzer and Transmission Test Sets generally require that the line be taken out of service and tested at each end with a compatible test set. These test sets require a known stimulus for all measurements except signal level and message circuit noise.

The choice between digital and analog measurements depends on the application. A telephone company, for instance, may not have access or responsibility for the digital side of the modem and analog measurements

are most suitable. A data communications end user can make go/no go tests most quickly with bit error rate tests and will only need to resort to analog testing where marginal circuit quality is suspected. Since malfunctions know no boundaries, it's important that the test equipment fit the problem.

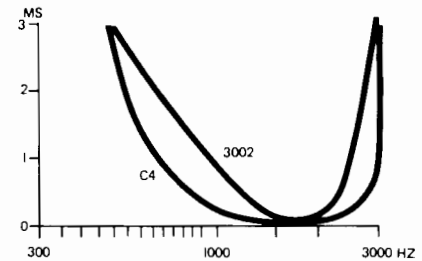

Figure 2. Advanced test sets like the 4940A, 4943A/4944A and 3770B can measure envelope delay distortion.

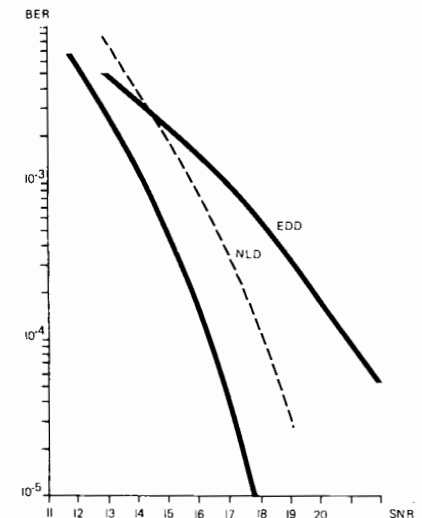

Figure 3. This classical performance characteristic for a modem shows how it is affected by line impairments. Data error analyzers can measure bit-error-rate (BER) in the digital domain. Transmission test sets like the 4935A can measure signal-to-noise ratio in the analog domain. Advanced test sets like the 3770B, 4940A and 4943A/4944A can measure envelope delay distortion (EDD). Further, the 4940A and 4944A can measure non-linear distortion (NLD).

MODEM TYPE	ANALOG		DIGITAL	PROTOCOL
	US	CCITT		
ASYNC < 2000 bps	3551A 4935A	3552A 4936A		
SYNC > 2000 bps	4940A 4943A 4944A 3771B	3770B 3771A	1645A 1645S	1640B
DDS				

Figure 4. Where to use the various HP instruments in a data communication system.

TELECOMMUNICATIONS TEST EQUIPMENT

Telephone Line Analyzer Model 3770B

- Delay and Attenuation Distortion measurements
- Compatible with CCITT Recommendation 0.81
- Rugged, portable, and really easy to use
- Makes all the maintenance measurements listed in CCITT Recommendation M.1060
- Optional slaving facilities

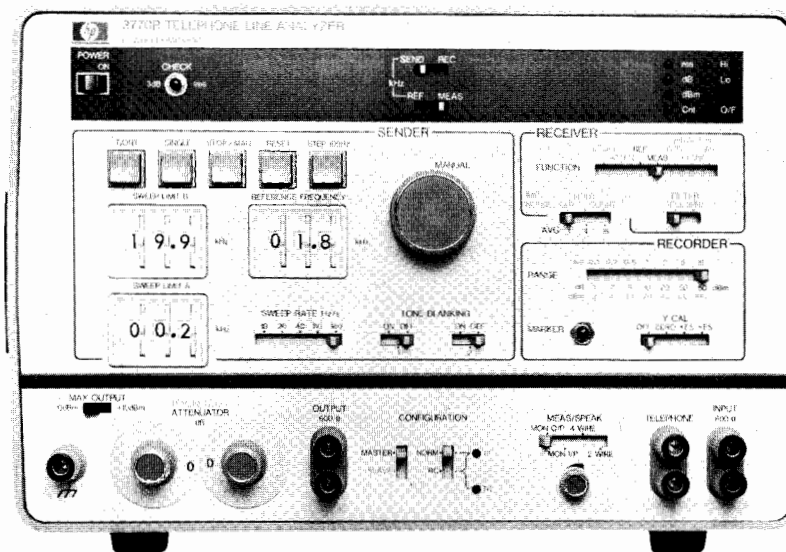

Description

The 3770B is designed for audio data line characterization to CCITT standards. The 3770B makes, in one combined unit, all of the routine maintenance measurements listed in CCITT Recommendation M.1060 for high speed data lines.

The 3770B measures group delay, attenuation distortion, and absolute level in the frequency range 200 Hz to 20 kHz. It has automatic ranging, zeroing, and synchronization, with simultaneous LED read-out of measurement result and frequency. The sender and receiver are combined in a single, rugged, portable unit.

The 3770B, in addition, measures weighted noise, noise-with-tone and impulse noise. Further, an optional slave facility for group delay and attenuation distortion measurements allows the measurement re-

sults for both directions of transmission on a 4-wire circuit to be displayed at one end of the circuit. Also, the measurements in both directions can be controlled from one end of the circuit, leaving the slave unit unattended.

The 3770B has X-Y recorder outputs to enable a permanent swept record of the measurements to be made. A suitable portable X-Y recorder can be supplied as an option. Pre-printed graph paper showing CCITT limits for group delay and attenuation distortion measurements can also be supplied.

The instrument also has a built-in telephone facility to allow voice communication in a 2- or 4-wire mode over the line or lines under test. An integral loudspeaker allows the operator to monitor either the receiver input or sender output.

Ordering Information

When ordering a 3770B, select ONE option from the table below (i.e. select the standard instrument OR one option). This completely specifies the measurements selected. Note that group delay, attenuation distortion and absolute level measurement facilities are provided with ALL instruments.

Option	Measurement Facilities				Price
	Noise	Slaving	+10 dbm Output	Tone Blanking	
STD	•				\$10,785
001		•			-\$170
002	•	•			+\$435
003	•		•		+\$70
004	•			•	+\$205
005	•		•	•	+\$205
006		•	•		-\$375
007		•		•	N/C
008		•	•	•	N/C
009	•	•	•		+\$435
010	•	•		•	+\$595
011	•	•	•	•	+\$595
020	•	•		•	+\$595

*This Option provides impulse noise measurements to CCITT Recommendation 0.71 in full, and a crosstalk measurement for balanced pair cables.

Opt 005: tone blanking add \$205

Range: two bands in the range 0.2 to 9.9 kHz.

Range limits: any multiple of 100 Hz.

Frequency range blanked (kHz): Opt # specifies range:

Opt	kHz	Opt	kHz	Opt	kHz	Opt	kHz
117:	0.4 to 0.6	103:	1.9 to 2.2	107:	2.3 to 2.7	111:	3.0 to 3.4
101:	0.5 to 0.7	104:	2.0 to 2.4	108:	2.4 to 2.8	112:	3.2 to 3.6
102:	0.6 to 0.9	105:	2.1 to 2.5	109:	2.6 to 3.0	113:	3.4 to 3.8
115:	0.8 to 1.2	106:	2.2 to 2.6	110:	2.8 to 3.2	114:	3.6 to 4.0
116:	1.4 to 1.8	Other ranges available. Order Opt 100 and specify ranges.					

Opt 012: loop holding for sender output receiver input. add \$185

Maximum dc loop holding current: 100 mA.

Voltage drop at maximum current: ~12 V.

Dynamic output impedance: ~50 kΩ.

In-lid operating instructions: English: std; German: N/C

Opt 031: French: Opt 032; Italian: Opt 033; Spanish:

Opt 034.

Opt 061: rack mount version. add \$220

Opt 910: additional set of manuals. add \$70

Opt C01: 0.75" banana connectors. add \$70

7010B Option 143: X-Y Recorder in carrying case \$1930

suitable for use with Model 3770B. Pre-printed graph paper showing CCITT limits also available; Amplitude Distortion (9280-0403), Delay Distortion (9280-0402).

\$10,785

- CCITT and Bell versions
- Simultaneous measurement of transients

- HP-IB option
- Optional printer output

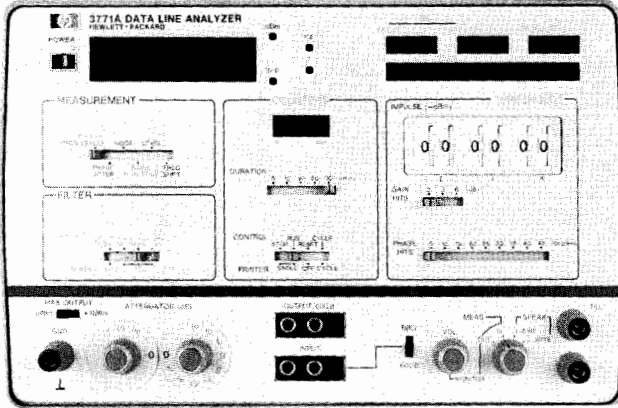

3771A

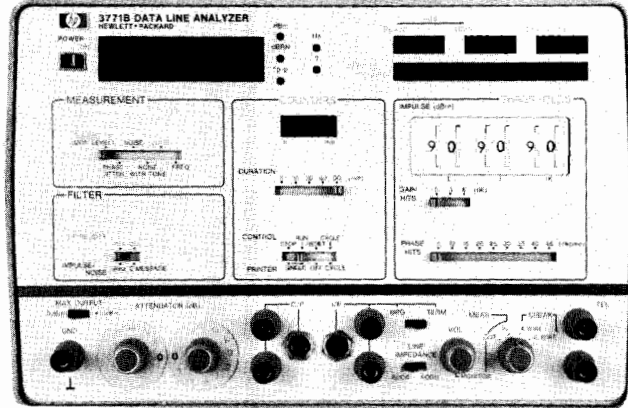

3771B



Description

The 3771A and 3771B Data Line Analyzers have been designed for making installation and troubleshooting measurements on telephone lines used for carrying high-speed data. Two versions are available—the 3771A is compatible with CCITT standards, the 3771B with Bell Publication 41009 (May 1975).

The 3771A is a companion instrument to the HP 3770B Telephone Line Analyzer. When used with the 3771A, it provides a complete portable easy-to-use CCITT data line testing facility. Routine data line maintenance measurements can be performed using the 3770B, and troubleshooting measurements using the 3771A. The 3771B can be used with the HP 4943A/4A Transmission Impairment Measuring Set for complete data line characterization and testing where Bell measurement standards are required.

The 3771A/B measures two basic types of impairment affecting data lines—steady state and transient.

The steady state parameters measured are:

- Level
- Phase Jitter
- Weighted Noise
- Noise-with-Tone
- Frequency Shift

The transients measured are (all measured simultaneously):

- 3-Level Impulse Noise
- Phase Hits
- Gain Hits
- Dropouts

Transient parameters are normally measured over 15-minute intervals and by measuring all of them simultaneously, the 3771A/B saves considerable operator time. Also, any comparison of results is statistically valid.

The 3771A/B can be used as a stand alone test instrument or as part of an automatic test system. An option allows the 3771A/B to be controlled externally via the Hewlett-Packard Interface Bus (HP-IB). Other optional features available are a printer output for recording the results of unattended long-term transient measurements, and dc loopholding for sender output and receiver input. In-lid

operating instructions are provided for the 3771A/B, in addition to the normal detailed operating booklet. In the 3771A, the in-lid instructions can be supplied in English, French, German, Italian, or Spanish.

Options (3771A and 3771B)

Option 001—+10 dBm Output (3771A only)
Output level: maximum sender output level 0 or +10 dBm, selected by switch.

Option 002—Loopholding
Option 003—Frequency Shift (3771A only)
Range: 0 to 10 Hz.

Tone frequencies: 1020 and 2040 Hz, in harmonic relationship.

Technique: compatible with CCITT Recommendation 0.111.

Option 004—Printer Output

Format: 8421 BCD.

Compatibility: HP 5150A, 5055A, 5050B.
Information: all transient data at end of each timer interval.

Option 005—HP-IB Data Output and Remote Control.

Option 006—LF Phase Jitter (3771B only)
Provides measurement of low frequency phase jitter components in three ranges: 4 to 20 Hz or 4 to 300 Hz (by internal selection) and 20 to 300 Hz.

In-lid Operating Instructions: (3771A only)
English—std; German—Option 031; French—Option 032; Italian—Option 033; Spanish—Option 034.

Prices

3771A/3771B

+\$58/NA

+\$140/+\$140

+\$320/NA

+\$220/+\$220

+\$590/+\$590

NA/+\$350

N/C/NA

Ordering Information

3771A Data Line Analyzer—CCITT

3771B Data Line Analyzer—North America

Price

\$8675

\$8675

TELECOMMUNICATIONS TEST EQUIPMENT

Transmission Test Sets

Models 3551A & 3552A

- Voice grade testing
- Data circuit testing



3551A
(North American)



3552A
(CCITT)

Description

Hewlett-Packard's 3551A (North American Measurement Standard) and 3552A (CCITT) Transmission Test Sets are rugged, portable and ideally suited for measurements on voice, program and data circuits up to 50 kb/s.

These four-function test sets are capable of measuring tone level, noise level, and frequency, while simultaneously sending tone. Both level and frequency are fully autoranging.

A normal sampling of 10/second in tone level and frequency allows a "direct feel" between an adjustment and the ensuing reading. In addition, a damped sample rate of 2/second is useful when reading noisy signals. The digital LED (Light Emitting Diode) readout displays either the level or frequency of the input or output regardless of terminal function selected.

Appropriate resolution, time constant and sample rate are automatically provided to simplify operation for the user.

These test sets can measure both two-wire and four-wire balanced circuits. Impedances of 135, 600, and 900 ohms can be selected on the 3551A; impedances of 150, 600, and 900 ohms are available on the 3552A. In addition, the receiver may be either terminated or bridged.

The test sets may be powered by either ac line or internal rechargeable batteries and are suited for both inside and outside plant maintenance.

A full wave average detector is used for tone level measurements. Automatic ranging eliminates the need to set attenuators and thus reduces the possibility of errors due to faulty calculations. Direct digi-

tal readout gives a 0.1 dB resolution over the entire 85 dB dynamic range.

For frequency measurements, a four-digit autoranging frequency counter is provided. The readout is calibrated in kHz and features 1 Hz resolution from 40 Hz to 10 kHz and 10 Hz resolution from 10 kHz to 60 kHz. The decimal point is automatically positioned to avoid the possibility of errors due to overflow of the four digits.

Noise measurements are made with a QUASI RMS detector and displayed in dBm on the 3551A and dBm on the 3552A, with 1.0 dB resolution. Display rate is slowed to 2 per second to provide analog feel of slowly changing noise levels. Both test sets have the capability of measuring noise-with-tone, message circuit noise, and noise-to-ground. Four switch selectable weighting networks are provided; C-message, Program, 3 kHz, and 15 kHz Flat in the 3551A; and Telephone (Psophometric), Programme, 3 kHz Flat and 15 kHz Flat in the 3552A. In the noise-with-tone position, a notch is inserted before the selected weighting network.

Send oscillator covers a frequency range of 40 Hz to 60 kHz in three bands: 40 Hz to 1 kHz, 200 Hz to 6 kHz and 2 kHz to 60 kHz. The output level is continuously variable from +10 dBm to -60 dBm.

In addition, a fixed position is provided to be used as the holding tone when making a noise-with-tone measurement.

A convenient set of clip-on dial terminals for connecting a lineman's handset is provided. This allows a line connection to be dialed up and then held in an off-hook (busy) condition while making either receive or send measurements on a two-wire wet line.

Specifications, Model 3551A & 3552A

Receiver

Level Measurements

Frequency range: 40 Hz to 60 kHz.
Dynamic range: +15 dBm to -70 dBm.
Resolution: 0.1 dB.
Sample rate: 10/second normal, 2/second damped.
Detector type: average responding.
Accuracy: at 25°C ± 10°C, temperature coefficient: ± 0.005 dB/°C beyond this range.

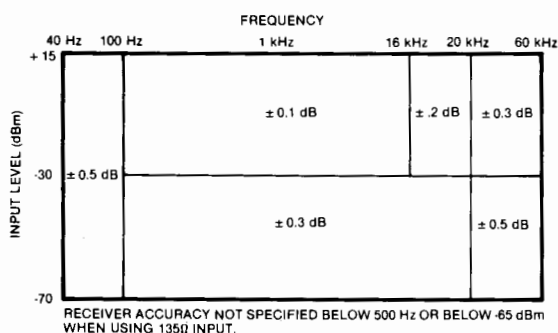

Frequency Measurements

Frequency range: 40 Hz to 60 kHz.
Dynamic range: +15 dBm to -70 dBm.
Resolution: 1 Hz (40 Hz to 10 kHz), 10 Hz (10 kHz to 60 kHz).
Sample rate: 10 second normal, 2/second damped.
Accuracy: ± 1 count.

Transmitter 3551A & 3552A

Frequency range: 40 Hz to 60 kHz.
Ranges: 40 Hz to 1 kHz, 200 Hz to 6 kHz, 2 kHz to 60 kHz, 800 Hz fixed, 3552A. (Other frequencies available.) 1004 Hz fixed, 3551A.
Resolution: 1 Hz (40 Hz to 10 kHz), 10 Hz (10 kHz to 60 kHz).
Sample rate: 10/second.
Harmonic distortion: < -50 dB THD (100 Hz to 4 kHz); < -40 dB THD (40 Hz to 100 Hz and 4 kHz to 20 kHz); < -30 dB THD (20 kHz to 60 kHz); < -55 dB (all harmonics 100 Hz to 4 kHz); < -60 dB THD (1004 Hz fixed).
Accuracy: ± 1 count.
Level range: +10 dBm to -60 dBm (40 Hz to 60 kHz), +6 dBm to -60 dBm. (1004 Hz fixed—3551A; 800 Hz fixed—3552A).
Resolution: 0.1 dB.
Sample rate: 10/second.
Accuracy: at 25°C ± 10°C, temperature coefficient: ± 0.005 dB/°C beyond this range.

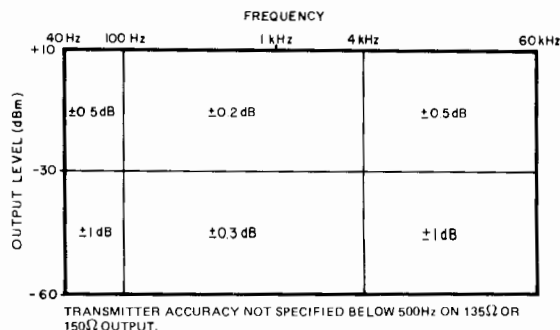

3551A Noise Measurements

Dynamic Range

Message circuit noise: 0 dBm to +85 dBm.
Noise-with-tone: 10 dBm to +85 dBm.
Noise-to-ground: 40 dBm to +125 dBm.
Resolution: 1 dB.
Sample rate: 2/second.
Detector type: Quasi-RMS responding.

Accuracy

Message circuit noise: ± 1 dB (+20 dBm to +85 dBm), ± 2 dB (0 dBm to +20 dBm).
Noise-with-tone: ± 1 dB (+20 dBm to +85 dBm), ± 2 dB (+10 dBm to +20 dBm).
Noise-to-ground: ± 1 dB (+60 dBm to +125 dBm), ± 2 dB (+40 dBm to +60 dBm).
Weighting filters: C-message, 3 kHz flat, 15 kHz flat, program.

3552A Noise Measurements

Dynamic Range

Message circuit noise: -90 dBm to -5 dBm.
Noise-with-tone: -80 dBm to -5 dBm.
Noise-to-ground: -50 dBm to +35 dBm.
Resolution: 1 dB.
Sample rate: 2/second.
Detector type: Quasi-RMS responding.

Accuracy

Message circuit noise: ± 1 dB (-70 dBm to -5 dBm), ± 2 dB (-90 dBm to -70 dBm).
Noise-with-tone: ± 1 dB (-70 dBm to -5 dBm), ± 2 dB (-80 dBm to -70 dBm).
Noise-to-ground: ± 1 dB (-30 dBm to +35 dBm), ± 2 dB (-50 dBm to -30 dBm).
Weighting filters: Telephone (CCITT Psophometric), 3 kHz flat, 15 kHz flat, Programme.

General

Monitor: built-in speaker, monitors received or transmitted signal.
Balanced impedances: 135Ω, 600Ω, 900Ω (3551A).
Balanced impedances: 150Ω, 600Ω, 900Ω (3552A).
Bridging loss: < 0.2 dB.
Return loss: > 30 dB, 40 Hz to 4 kHz, > 20 dB, 4 kHz to 20 kHz. Except 135 Ω > 30 dB 500 Hz to 4 kHz.
Longitudinal balance: > 60 dB at 6 kHz.
Hold circuit: 20 milliamps constant current. < 0.2 dB holding loss, resistive fuse protection.
Input/output protection: blocks 300 V dc.
Maximum longitudinal voltage: 200 V rms.
Battery supply: > 4 hours continuous operation on internal rechargeable batteries at 25°C. Battery drain is automatically turned off when discharged below proper operating level. Complete recharge in 12 hours.
Power requirements: 100 V, 120 V, 220 V, 240 V ± 10%; 48 Hz to 440 Hz; 4 VA.
Temperature range: 0°C to 55°C, operating; -20°C to +65°C storage.
Relative humidity: 0 to 95% (< 40°C).
Size: 133 mm H × 343 mm W × 254 mm D (5¼" × 13½" × 10").
Weight: net, 6.6 kg (14.5 lb). Shipping, 7.3 kg (16 lb).

Options

C01-3551A, C01-3552A: 19 inch rack mount, ac power only (no batteries)
H10-3551A: Extends frequency range to 85 kHz

Price

N/C

add \$355

Ordering Information

3551A Transmission test set \$2750.00
3552A Transmission set (CCITT) \$3005.00



TELECOMMUNICATIONS TEST EQUIPMENT

Transmission & Noise Measuring Set

Models 3555B & 3556A

- Voice and carrier testing

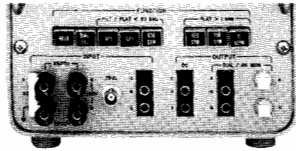

Description

Hewlett-Packard's 3555B Transmission and Noise Measuring Set is designed especially for telephone plant maintenance. It measures attenuation, distortion, cross-talk coupling and noise. Weighting networks designed to comply with Bell System Technical Reference Publication number 41009, and include C-message, 3 kHz, 15 kHz flat and program.

HP's 3556A performs the same tasks as the 3555B. It also has built-in weighting networks designed to that comply with CCITT requirements, which include telephone (psophometric) 3 kHz flat, and 15 kHz flat, Programme (P53) weighting filters.

Operating instructions printed in the protective cover are available in most languages at no extra charge.

Complementary equipment for the 3555B is HP 236A Telephone Test Oscillator (236A Opt. H10 for the 3556A). When used together, they make a complete transmission test set for accurate, convenient voice and carrier measurements.

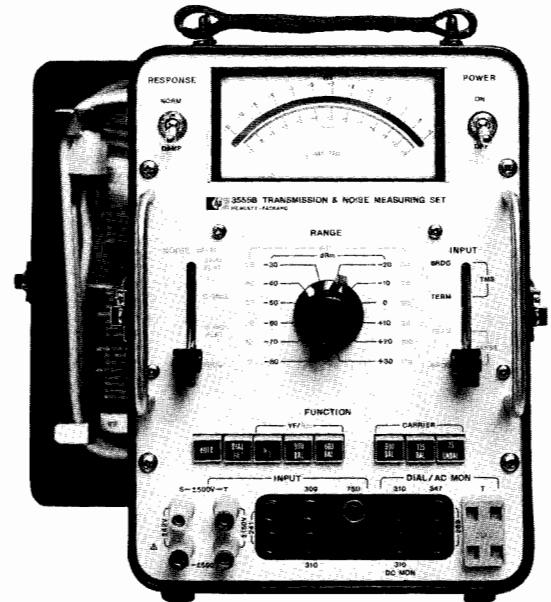

Specifications

	3555B (North American Standards)	3556A (CCITT Standards)
VOICE FREQUENCY LEVEL MEASUREMENTS: 20 Hz to 20 kHz		
dB/volt range	-91 dBm to +31 dBm	-78 dBm to +32 dBm/0.1 mV to 30 V F.S.
Level accuracy**	± 0.5 dB; ± 0.2 dB, 40 Hz to 15 kHz, level > 60 dBm	100 Hz to 5 kHz: ± 0.2 dB; 20 Hz to 20 kHz: ± 0.5 dB
Input	Terminated or bridged 600Ω or 900Ω balanced. Bridging loss: < 0.3 dB at 1 kHz. Balance: > 80 dB at 60 Hz > 70 dB at 6 kHz; > 50 dB to 20 kHz. Return loss: 30 dB min (50 Hz to 20 kHz)	Terminated: 600Ω symmetrical. Non-terminated: 10 kΩ symmetrical. Non-terminated error: < 0.4 dB at 800 Hz. Symmetry: > 80 dB at 50 Hz, > 70 dB at 6 kHz, > 50 dB to 20 kHz. Return loss: 30 dB min (50 Hz to 20 kHz)
Holding circuit	700Ω dc resistance, 60 mA max. loop line current at 300 Hz. With holding circuit in, above specs apply from 300 Hz to 4 kHz	
NOISE MEASUREMENTS:		
dB/volt range	-1 dBm to +121 dBm	-78 dBm to +32 dBm/0.1 mV to 30 V F.S.
Weighting filters	3 & 15 kHz flat, C-message, and program (Bell system technical reference pub # 41009)	3 & 15 kHz flat, Telephone and Programme (P53, CCITT)
Input	Same as for voice frequency measurements	
CARRIER FREQUENCY LEVEL MEASUREMENTS:		
dB/volt range	-61 dBm to +11 dBm	-48 dBm to +12 dBm/3 mV to 3 V F.S.
Level accuracy	600Ω balanced (symmetrical): 1 kHz to 150 kHz ± 0.5 dB; 10 kHz to 100 kHz, ± 0.2 dB. 135Ω balanced (or 150Ω balanced)†: 1 kHz to 600 kHz, ± 0.5 dB; 10 kHz to 300 kHz, ± 0.2 dB. 75Ω unbalanced (asymmetrical): 100 Hz to 600 kHz, ± 0.2 dB; 30 Hz to 1 MHz, ± 0.5 dB; 1 MHz to 3 MHz, ± 0.5 dB ± 10% of meter reading	
Input	Terminated or bridged 135Ω† or 600Ω balanced (symmetrical) and 75Ω unbalanced (asymmetrical)	
Return loss	600Ω: 26 dB min.; 3 kHz to 150 kHz; 135Ω†: 26 dB min. 1 kHz to 600 kHz; 75Ω: 30 dB min. to 3 MHz	
Bal/symmetry	> 70 dB to 10 kHz, > 60 dB to 100 kHz, > 40 dB to 600 kHz	
GENERAL:		
Meter	Linear dB scale	Linear dBm scale
External battery	24 V or 48 V office battery, < 15 mA	
Internal battery	Single NEDA 202, 45 V "B" battery Option H03 uses rechargeable batteries and similar to 3556A	4 rechargeable batteries (25 V total) or power line from 90 V to 250 V ac, 48 Hz to 440 Hz, < 10 VA. Option 001 uses same battery as 3555B
AC	115 or 230 V (specify for 3555B) (switch for 3556A) 48 Hz to 440 Hz, < 10 VA	
Dimensions	299 mm H x 197 mm W x 207 mm D (11 3/4" x 7 7/8" x 8 1/8")	
Weight	Net, 6.8 kg (15 lb). Shipping, 7.5 kg (17 lb).	
Jacks	Will accept Western Electric 241, 309, 310, 358, 289 and 347 plugs; 1011B hand-set or 52 type headset	Will accept Siemens 9 REL KLI-6A, 4 mm diameter banana plugs or 3-prong Siemens 9 REL STP-6AC connector
**For levels > 1 dBm accuracy spec applies only for freq. above 100 Hz. †150Ω for 3556A.		

Ordering Information

HP 236A Telephone Test Oscillator (complementary equipment for 3555B) see page 601

3555B Transmission and Noise Measuring Set
3556A Psophometer

Price
\$1925.00
\$1650.00

TELECOMMUNICATIONS TEST EQUIPMENT



Telephone Test Oscillators

Model 236A (Bell) Model 236A Opt H10 (CCITT)

- Voice and carrier testing



HP 236A

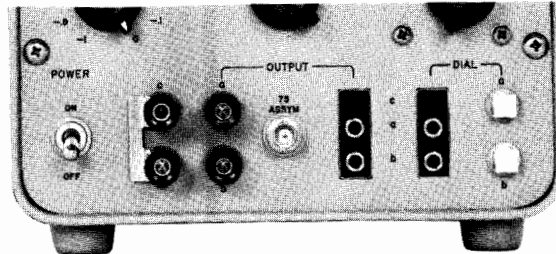

HP 236A Option H10

General

Hewlett-Packard's Models 236A and 236A Option H10/H20 Telephone Test Oscillators are particularly useful for lineup and maintenance of telephone voice and carrier systems when used with their companion instruments 3555B and 3556A Transmission Noise Meters. The HP236A Opt H10 and HP 3556A are designed to meet CCITT requirements, while the HP 236A and 3555A are designed to meet Bell requirements when used together.

Ordering Information

HP 236A Telephone Test Oscillator (North American)

Price

\$1400

Specifications

	236A (Bell)	236A Option H10 (CCITT)
Frequency range	50 Hz to 560 kHz	
Frequency dial accuracy	± 3% of setting	
Frequency response	± 0.3 dB from 50 Hz to 20 kHz	
600Ω output	± 0.3 dB from 50 Hz to 20 kHz	
900Ω output	± 0.3 dB from 50 Hz to 20 kHz	—
135Ω output	± 0.5 dB from 5 kHz to 560 kHz	—
150 and 75Ω outputs	—	± 0.5 dB from 5 kHz to 560 kHz
Output level/accuracy	-31 to +10 dBm in 0.1 dBm steps/ ± 0.2 dBm from -31 to +10 dBm (1 kHz ref., Opt H10, 800 Hz ref.).	
Noise	At least 65 dB below total output or -90 dBm—whichever noise is greater. 3 kHz bandwidth	
Distortion	At least 40 dB below fundamental output.	
Output circuit	Balanced (symmetrical) and floating. Can be operated up to ± 500 V dc above (earth) ground.	
Output impedance	600 and 900Ω ± 5% from 50 Hz to 20 kHz 135Ω ± 10% from 5 kHz to 560 kHz	600 and 150Ω symmetrical 75Ω asymmetrical
Output balance (output symmetry)	600 and 900Ω outputs: 70 dB at 100 Hz, 55 dB at 3 kHz 135 and 150Ω outputs: 50 dB at 5 kHz, 30 dB at 560 kHz	
Output jacks	Accepts Western Electric 241, 309, and 310 plugs.	Accepts 3-prong Siemens 9 REL, STP 6 AC or 4 mm diameter banana plugs.
	Binding posts accept banana plugs, spade lugs, phone tips or bare wires.	
Dial jacks	Accepts Western Electric 309 and 310 plugs. Clip posts accept Western Electric 1011B lineman's hand-set clips.	Accepts 3-prong Siemens 9 REL, STP 6 AC or 4 mm diameter plugs. Clip posts accept lineman's hand-set clips as alligator clips.
DC holding coil	600 and 900Ω outputs only. 700Ω ± 10% dc resistance; 60 mA maximum loop current at 100 Hz.	
Power requirements	Line: 115 or 230 V (switch) ± 10% ac, 48 Hz to 440 Hz, < 2 VA. Internal battery: single NEDA 202 45 V "B" battery. 236A Option H20: (same as 236A Option H10 except) five 6.25 V rechargeable batteries; 90 V ac- 250 V ac, 48 Hz-440 Hz, < 10 VA during battery charge.	
Weight	Net, 6.1 kg (13.5 lb). Shipping, 7.7 kg (17 lb)	
Complementary equipment	HP 3555B Transmission and Noise Measuring Set	HP 3556A Psophometer

TELECOMMUNICATIONS TEST EQUIPMENT

15 Hz to 50 kHz Selective Voltmeter

Model 3581C

- Voice grade testing
- Wideband data circuit testing
- Single frequency interference
- Spectrum analysis

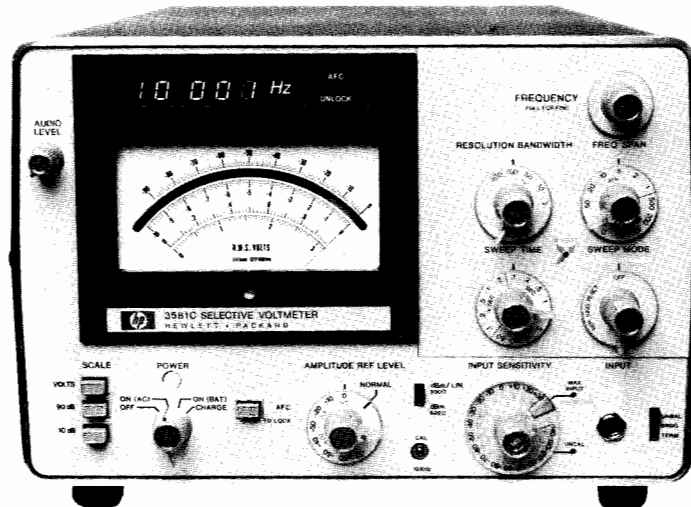

Description

The 3581C Selective Voltmeter has found wide application in testing special service circuits in both inside and outside plant maintenance. The 3581C is used to do spectrum analysis, measure non-linear distortion (harmonic distortion) and to locate and measure unwanted spurious and induced tones. The unit can be operated from ac line or from optional internal batteries.

Specifications

Frequency range: 15 Hz to 50 kHz.
Display: 5 digit LED readout. Resolution: 1 Hz. Accuracy: ± 3.5 Hz.
Typical stability: ± 10 Hz/hr. after 1 hour. ± 5 Hz/ $^{\circ}$ C.
Automatic frequency control (AFC), hold-in range: ± 800 Hz.
Pull-in range: > 5 x bandwidth for 3 Hz to 100 Hz bandwidth; > 800 Hz for 300 Hz bandwidth for full-scale signal.
Lock frequency: center of passband ± 1 Hz.

Amplitude

Instrument range

Linear: 30 V to 100 nV full scale.

Log: +30 dBm or dBV to -150 dBm or dBV.

Amplitude accuracy:	Log	Linear
15 Hz-50 kHz, frequency response	± 0.4 dB	$\pm 4\%$
Switching between bandwidths	± 0.5 dB	$\pm 5\%$
Amplitude display	± 2 dB	$\pm 2\%$
Input attenuator	± 0.3 dB	$\pm 3\%$
Amplitude reference level, Most sensitive range	± 1 dB	$\pm 10\%$
All other ranges	± 1 dB	$\pm 3\%$

Dynamic range: > 80 dB.

Noise sidebands: greater than 70 dB below CW signal. 10 bandwidths away from signal.

IF feedthrough: input level > 10 V: -60 dB; input level < 10 V: -70 dB.

Spurious responses: > 80 dB below input reference level.

Sweep

Scan width: 50 Hz to 50 kHz. These scans can be adjusted to cover a group of frequencies within the overall instrument range.

Sweep error light: this LED indicates a sweep that is too fast to capture full response.

*Note: these specifications cover the full temperature frequency and amplitude range, and represent worst case. Accuracy is significantly better for measurements not at the extremes.

External trigger: a short to ground stops normal sweep. Opening the short then enables a sweep.

Input

Unbalanced (UNBAL)

Impedance: 1 M Ω /40 pF.

Balanced/bridged (BRDG)

Impedance: 10 k Ω .

Frequency response: 40 Hz-20 kHz, ± 0.5 dBm for signals < 20 dBm.

Balanced/terminated (TERM)

Impedance: 600 Ω /900 Ω balanced.

Frequency response: same as balanced/bridging.

Input connector: accepts WECO 310 plug.

Output Characteristics

Tracking generator output (also known as BFO or tracking oscillator output). Switchable on rear panel to restored output (3581C acts as a narrow band amplifier).

Range: 0 to 2 V rms.

Frequency response: $\pm 3\%$ 15 Hz to 50 kHz.

LO output: 100 mV signal from 1 MHz to 1.5 MHz as input is tuned from 0 to 50 kHz.

Output connector: WECO 310, for connection to tracking generator output or restored output. In addition to monitoring restored output with headphones, an internal speaker also provides an audio indication of signal content.

Restored output: acts as a narrow band amplifier.

X-Y recorder analog outputs: 0 to +5V $\pm 2.5\%$.

General

Operating temperature range: 0 $^{\circ}$ C to 55 $^{\circ}$ C.

Humidity: 95% relative, maximum at 40 $^{\circ}$ C.

Power requirements: 100 V, 120 V, 220 V, 240 V $\pm 5\%$ -10%, 10 VA typical, 48 Hz to 440 Hz.

Size: 412.8 mm H x 203.2 mm W x 285.8 mm D (16 $\frac{1}{4}$ " x 8" x 11 $\frac{1}{4}$ ").

Weight: 11.5 kg (23 lb); Option 001, 13.5 kg (30 lb).

Accessory available: 7035B Option 20, X-Y recorder.

Option 001: Rechargeable battery: used to make floating measurements; 12 hours to fully charge. Also includes front panel dust cover.

Ordering Information

3581C Selective Voltmeter

Opt 001: Battery Pack, dust cover

7035B Opt 020: X-Y Recorder

Price

\$4650

add \$500

add \$2450

- Voice and carrier measurements

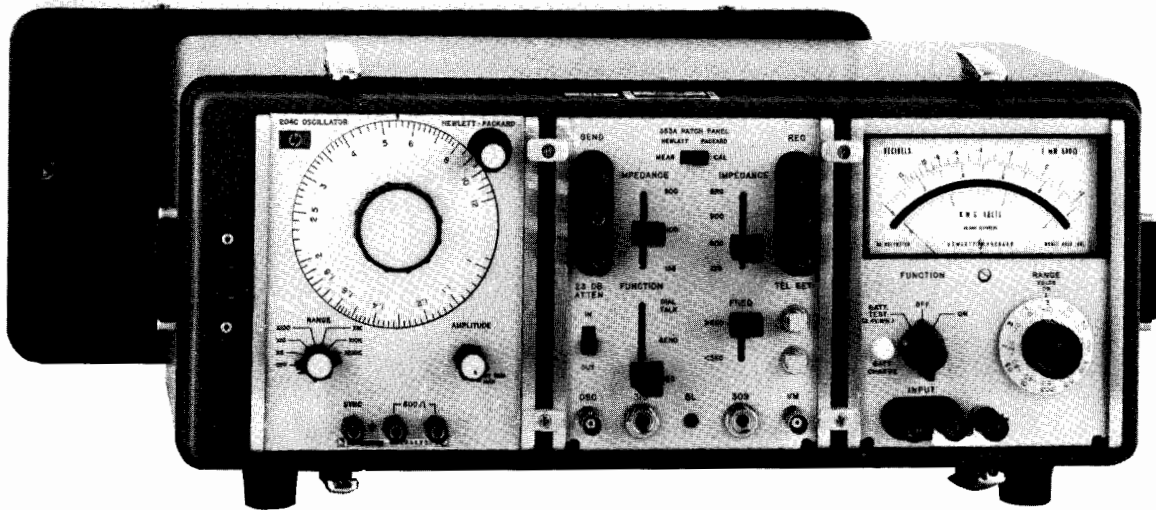

H02-3550B

Description

Hewlett-Packard's Model 3550B Portable Test Set is designed specifically to measure transmission line and system characteristics such as continuity and attenuation distortion. It is particularly useful for lineup and maintenance of multi-channel communication systems. Model 3550B contains a wide range oscillator, a voltmeter, and a patch panel to match both oscillator and voltmeter to 135, 600, and 900 ohm lines. These instruments are mounted in a combining case that is equipped with a splash-proof cover. In addition, the oscillator, voltmeter, and patch panel may be used separately whether they are in or removed from the combining case.

Both the oscillator and voltmeter are transistorized and operate from their internal rechargeable batteries or from the ac line. Batteries provide 40 hours of operation between charges and are recharged automatically during operation from the ac line.

Specifications

Oscillator HP 204C Opt H20

(Refer to Page 374)

Voltmeter, HP 403B Opt 001

(Refer to Page 74)

Patch Panel, HP 353A

(Specifications apply with oscillator and voltmeter)

Input (receiver)

Frequency range: 50 Hz to 560 kHz.

Frequency response:
±0.5 dB, 50 Hz to 560 kHz.

Impedance: 135Ω, 600Ω, and 900Ω and bridging (10 kΩ center tapped).

Balance: better than 70 dB at 60 Hz for 600Ω and 900Ω; better than 60 dB at 1 kHz for 600Ω and 900Ω; better than 40 dB over entire frequency range for 135Ω, 600Ω, and 900Ω.

Insertion loss: less than 0.75 dB at 1 kHz.

Maximum level: +10 dBm (2.5 V rms at 600 ohms).

Output (send)

Frequency range: 50 Hz to 560 kHz.

Frequency response: ±0.5 dB, 50 Hz to 560 kHz.

Impedance: 135Ω, 600Ω, and 900Ω center tapped.

Balance: better than 70 dB at 60 Hz for 600Ω and 900Ω; better than 60 dB at 1 kHz for 600Ω and 900Ω; better than 40 dB over entire frequency range for 135Ω, 600Ω, and 900Ω.

Insertion loss: less than 0.75 dB at 1 kHz.

Distortion: less than 1%, 50 Hz to 560 kHz.

Maximum level: +10 dBm (2.5 V rms into 600 ohms).

Attenuation: 110 dB in 10 and 1 dB steps.

Accuracy, 10 dB section: error is less than ±0.25 dB at any step.

Accuracy, 100 dB section: error is less than ±0.5 dB at any step.

Connectors: two 3-terminal binding posts for external circuit connection and two BNC female connectors for oscillator and voltmeter connection.

Patch Panel, Opt H02-353A

(Same as Model 353A except as indicated below)

Hold Circuit (rec terminals)

Frequency response: 300 Hz to 3 kHz ±0.5 dB, 1 kHz reference.

DC resistance: 240 ohms nominal.

Maximum DC current: 100 mA.

Maximum DC voltage: 150 volts.

Attenuation: 23 dB ±0.5 dB (1-step slide switch).

Hold Circuit (send terminals)

Frequency response: 300 Hz to 3 kHz ±0.5 dB, 1 kHz reference.

DC resistance: 240 ohms nominal.

Maximum DC current: 100 mA.

Maximum DC voltage: 150 volts.

Connectors: special telephone jacks to accept Western Electric No. 309 and 310 plugs. Sleeve jack is connected to sleeve of jacks 309 and 310. Two 3-terminal binding posts for external circuit connection.

Two terminals (Tel Set) connector for Hand Set, two BNC female connectors for oscillator and voltmeter connection.

Patch Panel, Opt H03-353A

(Same as Model H02-353A except Western Electric 241 connectors replace 3-terminal binding posts)

General

Size: 489 H x 213 W x 337 mm D (19.3" x 8.4" x 13.3") with cover installed.

Weight: net, 13.5 kg (30 lb). Shipping, 18 kg (40 lb).

Ordering Information

3550B Portable Test Set (with 353A Patch Panel) \$2350

H02-3550B (with H02-353A substituted for standard 353A) add \$375

H03-3550B (with H03-353A substituted for standard 353A) add \$350

TELECOMMUNICATIONS TEST EQUIPMENT

Transmission Impairment Measuring Sets (TIMS)

Models 4940A

- Complete analog testing of voice / data channels
- Compatible with North American Standard
- Low frequency phase jitter

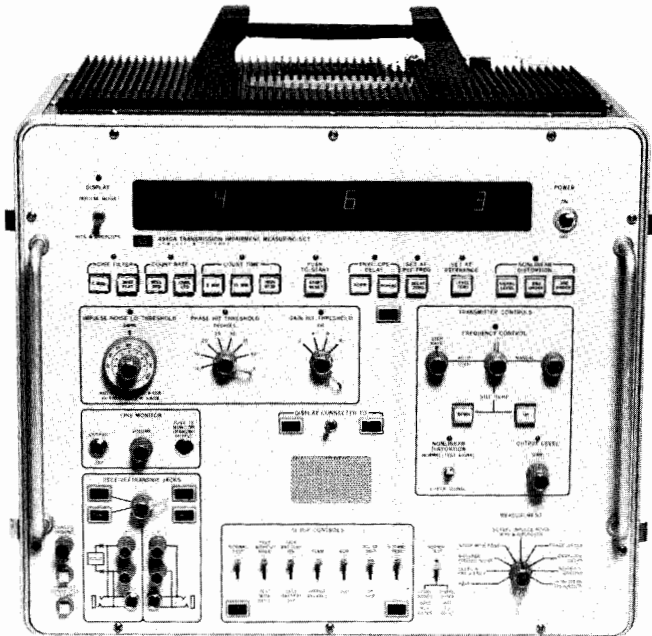

4940A

TIMS—Transmission Impairment Measuring Set

Most of the important analog parameters can be measured by a combined assortment of analog test sets which measure only a few parameters. However, TIMS are "stand alone" combination test sets that measure 7 to 15 parameters depending on the model and options selected. Thus TIMS can replace a large number of analog test sets. The major advantages of TIMS are that they cost significantly less and are more compact and more portable than a combination of test sets required to do the same measurements.

In addition to its cost savings and portability, TIMS are easy to operate. The switches on the front panel are logically arranged in functional groups. Simple straight-forward operating procedures allow the craftsperson or engineer to quickly and easily analyze voice band data channel.

4940A TIMS—Complete Analog Testing

The HP 4940A measures all the necessary parameters to completely describe the ability of a voiceband channel to carry medium and high speed data. The 4940A is the ideal tool for analyzing and troubleshooting C and D-1 conditioned lines.

With the HP 4940A it is possible simultaneously to observe all of the transients that cause data errors. By counting phase hits, gain hits, dropouts and three levels of impulse noise at the same time, a more accurate analysis can be made of error causes and channel quality. All of these transients are tallied by TIMS during the selected count time and stored in memory. The pushbutton-selectable count times are 5, 15 minutes and continuous. During the test and at the end of the count time, either the impulse noise totals or the hits and dropout totals may be displayed from memory.

The 4940A TIMS measures the peak-to-peak phase jitter in two separate bands. Bell standard phase jitter is measured in the frequency band of 20 Hz to 300 Hz, and Bell low frequency phase jitter is measured in the frequency band of 4 Hz to 20 Hz. By measuring the peak-to-peak phase jitter in each band, you can identify positively the existence of low frequency phase jitter from standard phase jitter.

4940A Specifications

For detailed specifications ask your local HP sales office for a 4940A TIMS data brochure.

General

Power: 105 to 129 V AC, 60 Hz, 130 watts.

Dimensions: 464 H x 470 W x 32.4 mm D (18.3" x 18.5" x 12.8").

Weight: net, 18 kg (39 lb). Shipping, 25 kg (54 lb).

Options

Options	Price
001: adds P/AR measurement	add \$500
002: adds nonlinear distortion measurement	add \$875
003: adds P/AR and nonlinear distortion measurements	add \$1,350
004: adds P/AR, nonlinear distortion and low frequency phase jitter	add \$1,950
010: Field carrying case	add \$300
019: 19" Rack Mount Adapter, deletes cover	N/C
023: 23" Rack Mount Adapter, deletes cover	N/C

The nonlinear distortion technique is licensed under Hekimian Laboratories, Inc., USA Patent No. 3862380.

4940A Transmission Impairment Measuring Set **\$12,400**

Measures level and frequency, message circuit noise (C-message and 3 kHz flat), noise-with-tone, 3-level impulse noise, phase hits, gain hits, dropouts, phase jitter, envelope delay, noise-to-ground.

Low frequency phase jitter can be retrofit at an HP Service Center.

4940A, 4943A and 4944A Comparison

Measurement	4940A	4943A	4944A
Message Circuit	•	•	•
Noise-C-Message	•	•	•
3 kHz Flat	•	•	•
Noise with Tone	•	•	•
Attenuation Distortion	•	•	•
Envelope Delay Distortion	•	•	•
Impulse Noise 1 Level	•	•	•
3 Levels	•	•	•
Phase Hits	•	•	•
Gain Hits	•	•	•
Dropouts	•	•	•
Phase Jitter	•	•	•
Low Frequency Phase Jitter	•†	•†	•
Non-Linear Distortion	•†	•	•
Peak to Average Ratio	•†	•	•
Noise to Ground	•	•	•
Signal to Noise Ratio	•	•	•
† Options			

TELECOMMUNICATIONS TEST EQUIPMENT

Transmission Impairment Measuring Set (TIMS)

Models 4943A and 4944A

605



- Portable for field service tests
- Analog testing of voice/data channels

- Master-slave for remote end-to-end testing
- Automatic self check

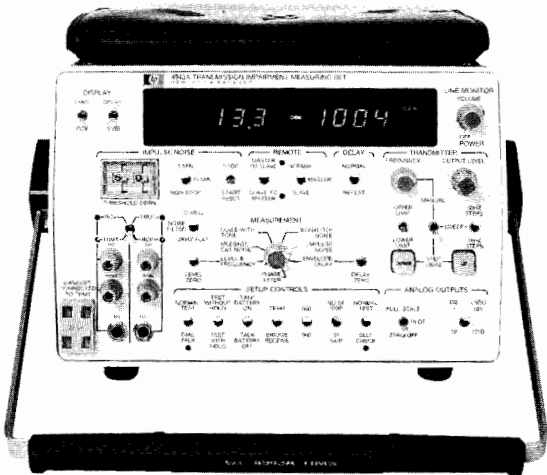

4943A



4944A



4943A TIMS

Gives You a Permanent Record of Your Measurements

The analog output circuit allows you to display the measured signal on a CRT display or record it on an X-Y recorder or strip chart recorder. Built-in storage and internally generated graticule lines allow you to use non-storage oscilloscopes or uncalibrated CRT display.

MASTER-SLAVE operation allows remote end-to-end testing without adding an external controller. The Slave unit operates unattended, with measurements in both directions controlled and displayed by the Master unit. Adding the HP-IB option provides automatic testing.

4943A Specifications

For detailed specifications ask your local HP Sales Office for a 4943A TIMS Data Brochure.

General

Power: 100, 120, 220, 240 V AC +5% -10%, 48 to 66 Hz.

Size: 196 H x 338 W x 591 W mm D (7.7" x 13.3" x 23.3").

Weight: 12.2 kg (27 lb).

Options

010: HP-IB Interface	\$550.00
012: Nonlinear distortion replaces phase jitter	\$600.00
015: 18055A Transit Case	\$350.00
019: 10491B 19" Rack Mount	\$150.00
910: Extra set manuals	\$125.00

4943A Transmission Impairment Measuring Set

\$9400.00

Measures level and frequency, message circuit noise (C-message and 3 KHz Flat), 1 level impulse noise, signal-to-noise ratio, envelope delay, phase jitter. Analog outputs with internal storage and internally generated graticules, two holding coils, MASTER-SLAVE feature, and portable mainframe. Low frequency phase jitter, either 4-20 Hz or 4-300 Hz, available on special order.

4944A TIMS

Measures All Parameters for C & D Conditioned Channels

The 4944A TIMS measures all parameters including nonlinear distortion, tariffed for C- and D-conditioned leased data lines. Non-linear distortion is measured using the four tone intermodulation distortion technique. This technique is licensed under Hekimian Laboratories, Inc. USA Patent No. 3862380. The 4944A TIMS computes the 2nd and 3rd order products and automatically corrects the readings for noise.

Applications for the 4944A TIMS include circuit routing, circuit troubleshooting and installation testing. The portable 4944A is designed for both field service use and test center use.

4944A Specifications

For detailed specifications ask your local HP Sales Office for a 4944A TIMS Data Brochure.

General

Power: 100, 120, 220, 240 V AC, +5% -10%, 48 to 66 Hz.

Size: 196 H x 338 W x 591 mm D (7.7" x 13.3" x 23.3").

Weight: 12.2 kg (27 lb).

Options

001: Deletes nonlinear distortion	\$800.00
010: HP-IB Interface	\$550.00
015: 18055A Transit Case	\$350.00
019: 10491B 19" Rack Mount	\$150.00
910: Extra set of manuals	\$125.00

4944A Transmission Impairment Measuring Set

\$9400.00

Measures level and frequency, message circuit noise (C-message and 3 KHz Flat), signal-to-noise ratio, 1 level impulse noise, envelope delay, non-linear distortion, two holding coils, MASTER-SLAVE feature, and portable mainframe.

TELECOMMUNICATIONS TEST EQUIPMENT

Transmission Impairment Measuring Sets (TIMS)

Model 4935A/4936A

- Tests Level vs. Frequency to 110 kHz
- Tests Noise
- Test 3 Level Impulse Noise
- Tests P/AR (4935A Option)



4935A

- C Message/3 KHz
- Program/15 KHz
- 50 k Bit (DDS)
- Noise to ground

Quality Circuits for Voice, Data, or Program

The 4934A/4936A Transmission Impairment Measuring Sets provide the basic tests to qualify circuits for voice, data or broadcast program transmission up to 110 KHz. The new 4936A, designed for the CCITT world, has both quasi peak and quasi rms detectors to perform sound channel testing using the CCIR recommended techniques. Strip chart recorder outputs are standard. The 4935A does all the required a.c. tests to qualify the local loop for Digital Dataphone Service to 56 k bps. With the 4935A datacom system users can isolate line faults from equipment faults and call the right vendor first. The P/AR measurement option on the 4935A gives system users a powerful yet simple measure of the combined factors which effect the overall data transmission quality of the line. The P/AR test was developed by Bell Laboratories and is useful as a benchmark of a line's data transmission quality.

PABX and other telecommunications equipment service people will find the 4935A has the analog testing capability they need. Independently selectable transmit and receive impedances make it convenient to test switches at trunk to toll interfaces. For the new generation switches that handle both voice and data, the 4935A offers all tests in one instrument.

Easy To Use

The TIMS family from HP is noted for being easy to use. The 4935A/4936A upholds this tradition with features like being able to store and then recall 4 independent test tone frequencies which are easily changed by the user from the front panel.

Both the North American and CCITT versions offer SF SKIP (tone blanking) which prevents the transmitter from sending unwanted frequency bands such as the disconnect tone. This 300 Hz band is easily selectable from the front panel.

Portable for Field Use

The 4935A/4936A in its rugged polycarbonate case weighs only 11 pounds (or 14 pounds) with a battery option). A rechargeable battery pack option will provide power in remote areas.

Accessories Available (Fit Either 4935 or 4936)

- 18132A-19" Rack mount kit
Does not require removal of the instrument's handle.
Uses only 7" of rack space. Price \$150.
- 18134A-Vinyl soft pack carrying case.
The carrying case has a deep pouch for manuals and test cords. The adjustable shoulder strap permits hands-free carrying. Price \$125

Options

4935A Standard

- 001: Adds rechargeable battery pack
- 002: Adds P/AR test, deletes noise to ground
- 003: Adds both the battery pack and P/AR

4936A Standard (820 Hz Tone and Notch)

- 001: Adds rechargeable battery pack to standard
- 002: 1020 Hz tone and notch
- 003: 1020 Hz tone plus rechargeable battery pack

4935A

Specifications Level and Frequency

4936A

Transmitter

Frequency range: 20 Hz to 110 KHz

Resolution: ±1 Hz to 100 KHz
±10 Hz, >100 KHz

Level range: -40 to +13 dBm

Distortion:

	100 Hz	4 K	110 K
Output Level (+10 dBm)	-55 dB	-50 dB	-50 dB
Output Level (0 dBm)	-50 dB	-40 dB	-40 dB
Output Level (-40 dBm)	-50 dB	-40 dB	-40 dB

Distortion in hold tone @ 0 dbm is -65 dB

Transmitter

Frequency range: 20 Hz to 110 KHz

Resolution: ±1 Hz to 100 KHz
±10 Hz, >100 KHz

Level range: -40 to +13 dBm

Distortion:

	100 Hz	4 KHz	110 K
Output Level (+10 dBm)	-55 dB	-50 dB	-50 dB
Output Level (0 dBm)	-50 dB	-40 dB	-40 dB
Output Level (-40 dBm)	-50 dB	-40 dB	-40 dB

TELECOMMUNICATIONS TEST EQUIPMENT

Transmission Impairment Measuring Sets (TIMS) (Cont.)

Model 4935A/4936A



- Psophometric (P. 53)
- Sound, unweighted (J. 16)
- Sound, weighted (J. 16)
- Quasi peak and quasi rms detectors

4936A

4935A

Stored frequencies: 404 Hz, 1004 Hz, 2804 Hz, 2713 Hz

SF Skip Skips: 2600 Hz \pm 150 Hz

Level flatness: from -40 to +10 dBm

20-200 Hz \pm 1.0 dB

200-15 KHz \pm 0.2 dB

15 K-85 KHz \pm 0.5 dB

Receiver

Frequency range: 20 Hz to 110 KHz

Resolution: \pm 1 Hz to 10 KHz

\pm 10 Hz, > 10 KHz

Level range: -60 to +13 dBm

Level accuracy: from -40 to \pm 13 dBm

20-50 Hz \pm 1.0 dB

50-200 Hz \pm 0.5 dB

200-15 KHz \pm 0.2 dB

15 K-85 KHz \pm 0.5 dB

4935A

Range:

Message Circuit Noise: 0 to 100 dBm

Noise With Tone: 10 to 100 dBm

Noise to Ground: 50 to 130 dBm

Detectors: Quasi rms

Notch filter: > 50 dB rejection from 995 to 1025 Hz

Threshold ranges @ 600 Ω

Low 30 to 109 dBm

Mid 4 dB above low to 109 dBm

High 8 dB above low to 109 dBm

Range of tone: -40 to +13 dBm

Transmitted level range: -40 to 0 dBm

Received level range: -40 to +3 dBm

P/AR range: 0 to 120 P/AR units

Resolution: 1 P/AR unit

General

Impedance: 135 Ω , 600 Ω , 900 Ω

Filters: C Message
3 KHz Flat
15 KHz Flat
Program
50 k Bit

4936A

Stored frequencies: 300 Hz, 820 Hz*, 2000 Hz, 3000 Hz

Tone blanking: SK Skip Skips 2280 Hz \pm 150 Hz

Level flatness: from -40 to +10 dBm

20-100 Hz \pm 1.0 dB

200-15 KHz \pm 0.2 dB

15 K-85 KHz \pm 0.5 dB

Receiver

Frequency range: 20 Hz to 110 KHz

Resolution: \pm 1 Hz, to 10 KHz

\pm 10 Hz, > 10 KHz

Level range: -70 to +13 dBm

Level accuracy: from -40 to \pm 13 dBm

20-50 Hz \pm 1.0 dB

50-100 Hz \pm 0.5 dB

100-4 KHz \pm 0.1 dB

4 K-15 KHz \pm 0.2 dB

15 K-85 KHz \pm 0.5 dB

*1020 Hz tone and notch is available as an option.

Noise Measurements

4936A

Range:

Noise: -90 to +10 dBm

Noise with tone: -80 to +10 dBm

Detectors: Quasi rms

Quasi peak—Monitored by analog outputs

Notch filter: > 50 dB rejection from 800-855 Hz*

3 Level Impulse Noise

Threshold ranges @ 600 Ω

Low -60 to +16 dBm

Mid 3 dB above Low to +16 dBm

High 6 dB above Low to 16 dBm

Range of tone: -40 to +13 dBm

Peak to Average Ratio

Not offered

General

Impedances: 150 Ω , 600 Ω , 900 Ω

Filters: Psophometric (P. 53)

275-3250 Hz Flat (0.71 Impulse Noise)

Sound Unweighted (J. 16)

Sound Weighted (J. 16)

*With option 1020 Hz tone notch is same as 4935A.

TELECOMMUNICATIONS TEST EQUIPMENT

Troubleshooting Computer Communications Networks

Model 1640B



1640B

1640B Description

Selective transparent monitoring and interactive simulation make Hewlett-Packard's 1640B Serial Data Analyzer a valuable tool for quickly locating faulty components in computer networks and most RS-232-C (V24) interfaces. Regardless of network size, system downtime is minimized when the problem source can be isolated rapidly. Model 1640B combines the convenience of programmed operation in real time with the versatility of a variety of triggering modes: character sequences, time intervals, transmission errors, and external. Whether in design, systems integration, preventative maintenance, or on-line debugging, the 1640B aids you in moving efficiently from the symptom to the cause.

As a passive monitor, the Serial Data Analyzer collects status information and serial data on the RS-232-C (V24) interface and records up to 2048 characters in memory. You can monitor all data flow, or restrict your data window to specific data types by suppressing the collection of nonpertinent information. Once connected, the 1640B does not interrupt the communication links, permitting you to troubleshoot the system at operating speeds.

In the interactive mode, Model 1640B can simulate the output of a DTE (Data Terminal Equipment) unit or the output of a modem, effectively exercising the entire system for analysis and troubleshooting. Configurations for simulation modes of operation are set quickly on the patch panel matrix which defines the RS-232-C (V24) interface. A separate 1024-character transmission memory contains messages you construct from the 1640B keyboard, enter using a ROM or the HP-IB option with a computer-controller, or "copy" from the 1640B monitor memory. Messages may be transmitted directly or separated for sequential transmission. Branch modes are used to simulate a CPU polling sequence, with one of two simulated replies sent conditional on the stimulus message.

Any character displayed on-screen can be selected with the display cursor for decoding in the code in use, hexadecimal, octal, and binary. The entire contents of memory are accessible by using the up/down cursor keys. This feature was added for the convenience of the operator in entering the code from the 1640B keyboard or checking for skipped bits.

Easy-to-Use

Operating Model 1640B Serial Data Analyzer is simple and easy to learn because the 1640B uses interactive menus to set up the analysis modes. Each menu presents the appropriate variables, and specific parameters are chosen from a fixed set with the display cursor and Field Select key, or set directly from the keyboard. The four menu keys across the top of the keyboard are FORMAT, MODE (Monitor or Simulate), TX ENTRY, and LIST. Once the menu is selected and the parameters set, the actual operation of the 1640B is automatic, freeing you from learning extensive instruction sets and writing programs for specific tests and simulations.

When the HP-IB interface is added, Option 001, you can further simplify set up and operation of the Serial Data Analyzer with Model 10291B PROMs. Each PROM holds two instrument setups for Format, Mode, and TX Entry menus. Up to five PROMs, ten setups, can be installed in the HP-IB board and loaded into the 1640B by setting rear panel switches and pushing the Load pushbutton. This reduces the opportunity for operator error and is particularly convenient for field applications.

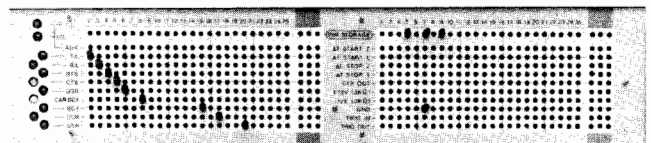

The matrix of the 1640B Serial Data Analyzer provides a versatile interface to configure the analyzer for various applications. When configured as shown here, the analyzer is set for most RS-232-C (V24) applications.



TELECOMMUNICATIONS TEST EQUIPMENT

Six Simultaneous, Automatic Data Measurements

Models 1645A & 10235A

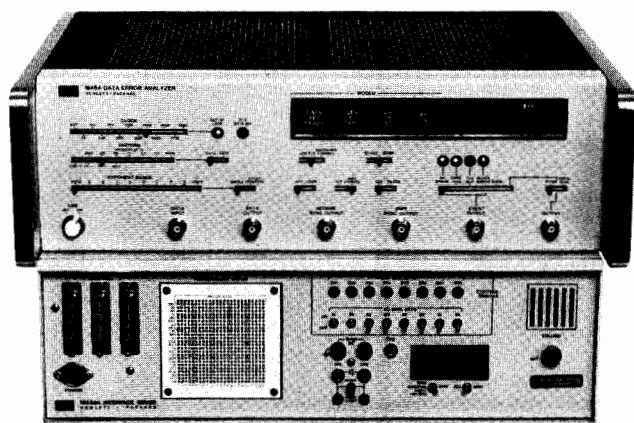

1645S

1645A Description

Hewlett-Packard's Model 1645A Data Error Analyzer quickly isolates data communications link problems through six simultaneous measurements. During tests, the 1645A can be left totally unattended because it automatically maintains synchronization even in the presence of dropouts. And for added convenience, the 1645A can be equipped with a printer for hard-copy, permanent recordings of long tests.

Bit-error and block-error rate tests are autoranged and displayed directly on an LED readout, there is no need to perform any calculation. Additionally, the 1645A measures jitter or total peak distortions, (the sum effect of jitter and bias), counts the number of times carrier loss or dropouts occur, measures data-error skew and counts the number of clock slips resulting from phase hits on the link or modem sync problems.

With all these measurements made during the same test interval, you'll know precisely where your problem is.

1645A Specifications

Bit Rate

Internal

Transmitter bits per second: selectable 75, 150, 200, 300, 600, 1200, 1800, 2400, 3600, 4800, 7200, 9600.

External: transmitter and receiver, to 5 MHz.

General

Power: 115 or 230 V ac, 48 to 440 Hz, 150 VA max.

Dimensions: 133 H x 425 W x 286 mm D (5¼" x 16¾" x 11¼").

Weight: net, 8.2 kg (18 lb). Shipping, 10.9 kg (24 lb).

Accessories supplied: one 3 m (10 ft) RS-232C interconnecting cable to connect the 1645A to the modem, connects to 10235A when used in the 1645S configuration (HP P/N 01645-61605), one 2.3 m (7.5 ft) 3 wire power cord (HP P/N 8120-1378); one Operating and Service Manual.

Indicators

Out of lock; received data inverted; bit error; carrier loss; clock slip; block error; data set ready (DSR); clear to send (CTS); loss of data; test on.

10235A Specifications

Time Interval

Range: 999 ms full scale.

Resolution: 1 ms.

Accuracy: $\pm 2\%$ of measured interval ± 1 count.

Start-Stop: TP1 & TP2 input, LED indicates event start at TP1 or TP2.

DC Digital Voltmeter

Ranges: 19.99 V, 199.9 V full scale.

Accuracy: $\pm 1\%$ of reading, ± 1 count.

10235A Interface Cover

The 10235A Interface Cover is designed for troubleshooting problems on the RS-232C interface bus. Common problems such as wrong voltages and excessive turnaround times, which often occur during installation, are easily pinpointed with the measurement capability of the interface cover.

Measurements include time interval, voltage measurements, audio monitoring, data set control signal monitoring, and the ability to send control signals to the data sets. This measurement capability can be easily patched through the 25 x 25 pin matrix to every pin of the RS232C interface for complete testing.

Control information can also be exchanged between the 10235A and the data set by using any of the eight data set control switches. In addition control signals from the data set can be monitored through the matrix on the eight control signal indicators.

Indicator and Control Functions

Indicators: eight light emitting diodes.

Audio: built-in loudspeaker and volume control.

Control switches: eight switches supply control signals.

General

Power requirements: +15 V to 25 V and -15 V to -25 V supplied by the 1645A.

Dimensions: 132 H x 399 W x 48 mm D (5.2" x 15.7" x 1.9").

Weight: net, 1.8 kg (4 lb). Shipping, 3.2 kg (7 lb).

Accessories supplied: one 46 cm (18") RS-232C interconnecting cable connects 10235A to 1645A (HP P/N 10235-61606); one accessory pouch, attaches to side of 1645A (HP P/N 1540-0385); one Operating Note.

Ordering Information

	Price
1645A Data Error Analyzer	\$3800
Opt 908: includes rack mounting kit	add \$20
Opt 910: additional set of manuals	add \$15.50
10235A Interface Cover	\$2200.00
1645S Data Communications Test Set*	\$6800
Opt 910: additional set of manuals	add \$25

Interfaces

	Price
Model 10387A for Type 303 modems (with cable)	\$510
Model 10388A for CCITT V35 (with cable)	\$510
Model 10389A Breakout Box (RS-232C)(with cable)	\$300
Model 18062B MIL-STD-188C Interface	\$240
Model 18063A RS449 Interface	\$240

Accessories

Printer interconnecting cable: Model 10233A cable connects the 1645A to HP Model 5055A or 5150A printers; 36 pin male connector on one end and 50 pin male connector on the other.	\$100
---	-------

*Includes 1645A, 10387A, 10388A 10389A, 10235A, and interconnecting cables.

TELECOMMUNICATIONS TEST EQUIPMENT

613

Cable Maintenance and Construction Test Sets

Models 4960, 4961, 4910G, 4930A, 4904A, 4905A, 4918A



CMC Test Sets

For cable maintenance and construction (CMC), Hewlett-Packard offers test sets that will locate any fault that is likely to occur in a cable. In addition, advanced pair identifier systems provide simplified, fast identification of wire pairs. Mostly used by telephone operating companies, this test equipment is also employed in other areas such as a power company, cable TV service, city government, military and electrical contractors.

The easy-reference matrix (below) shows the areas that our test sets are used most effectively. It cross-references the test sets to specific tasks in aerial, buried and underground cables.

Fault Isolation and Repair

The flowchart (below) shows the sequence of steps necessary to isolate and repair a cable fault. Sometimes, given experience and knowledge of the cable route, it's possible to eliminate a step or combine steps, but the testing sequence must still follow the flowchart. In addition, the trouble situation should be thoroughly analyzed at each step to make sure you're still on the right track and provide additional clues to the trouble.

	Buried Plant								Aerial or Underground Plant						
	Path/Depth	Shield or Conductor to Earth	Short	Cross	Ground	Split	Open	Pair I.D.	Short	Cross	Ground	Split	Open	Pair I.D.	Gas Leak
ULTRASONIC DETECTORS															
4905A															
4918A															
DIRECT READING FAULT LOCATORS															
4910F															
4910G															
4930A			H	H	H				H	H	H				
SHEATH FAULT AND CABLE LOCATORS															
4900A															
4904A															
PAIR IDENTIFIERS															
4960A/B															
4961A/B															

H = Maximum sensitivity to high resistance faults

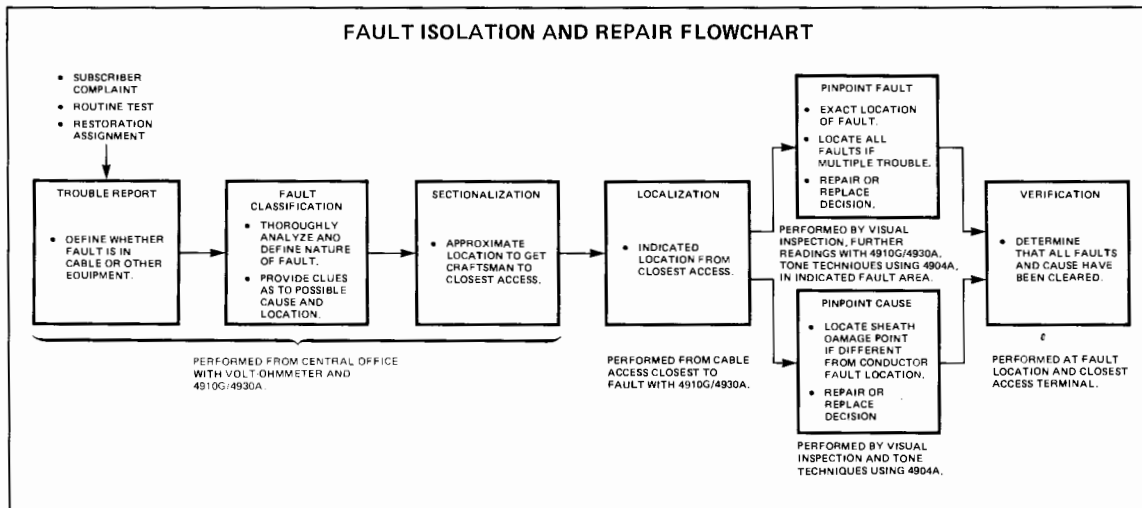

TELECOMMUNICATIONS TEST EQUIPMENT

Telephone Outside Plant Instruments

Models 4960, 4961, 4910G, 4930A, 4904A, 4905A, 4918A (Industrial Model)

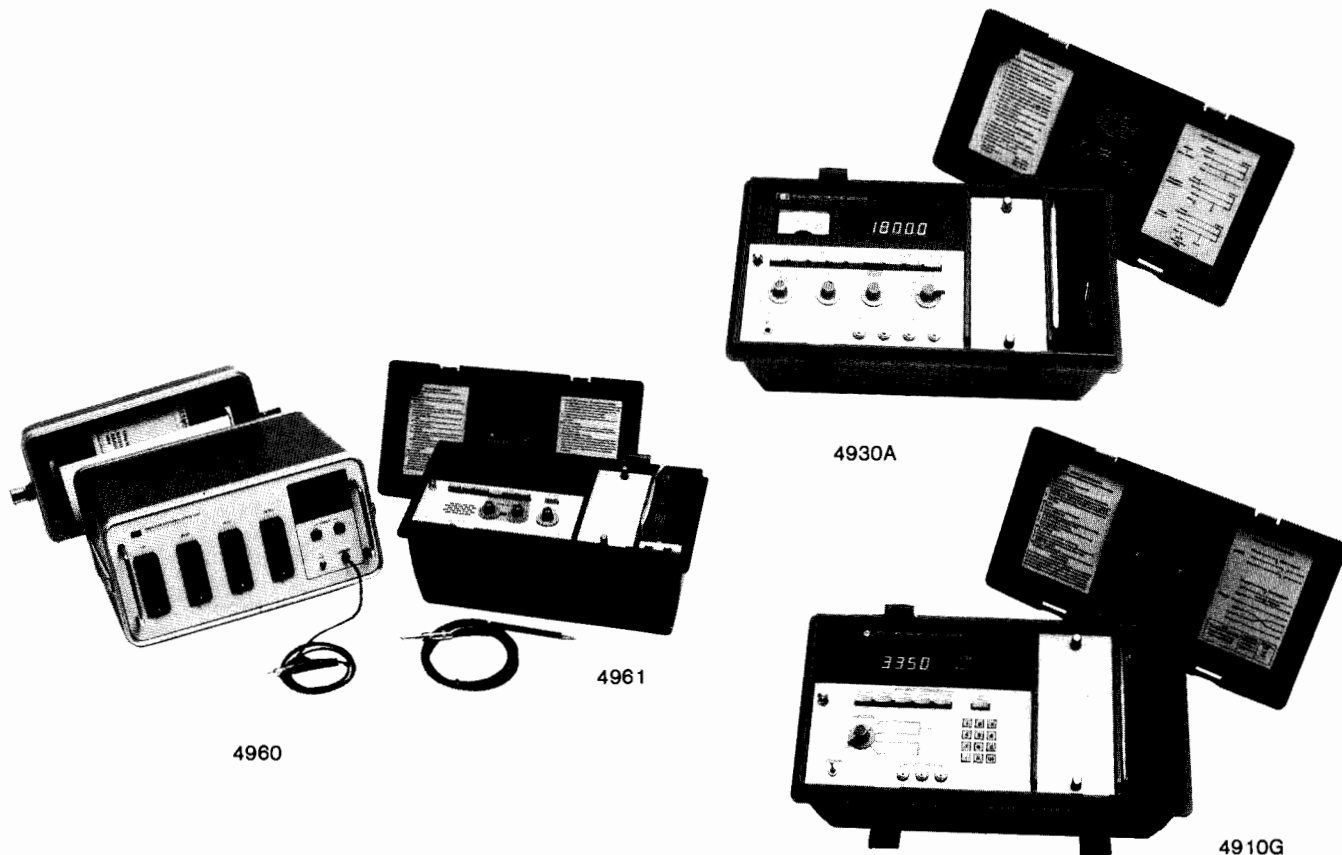

4960/4961 Automatic Pair Identifier System

An increasing need to rearrange telephone cables and pairs as well as a higher labor content associated with such activities has resulted in a need for fast, reliable pair identification equipment. The 4960/4961 System reliably identifies and tests working and nonworking telephone cable pairs in loaded or nonloaded telephone cables up to 40,000 feet in length. The system consists of the 4960 Office Unit and the 4961 Field Unit. The Field Unit is operated by the craftsman in a manhole or other access point. A pushbutton starts the operation of testing, identifying and determining the status of each pair.

There are four operating modes: Self Check, Shoe Check, Scan Mode and Select Mode. Self Check tests the operation of the units. Shoe Check determines if all the pairs in the shoe are making good contact to the mainframe. Scan Mode determines the pair number of a randomly chosen pair within the hundred pair count. Select Mode instructs the Office Unit to apply an audible tone to any selected pair in the count for a specific pair identification. The Select Mode is useful for identifying pairs that do not identify in the Scan Mode and for determining the problem on a faulted pair.

No control pair is required for communication between the Office and Field Units. Other features include bad, busy and reversed pair indications as well as large, lighted digital displays.

Direct Reading Fault Locators

Field instruments that provide a direct distance-to-fault reading in feet (or metres) have the benefit of relieving the craftsman of the drudgery of performing manual calculations. Locating faults becomes faster, requires less training and is less error prone than with manual bridge techniques. The 4910G and 4930A provide these automatic readings.

4930A Conductor Fault Locator

The 4930A is an automatic, digital, direct reading test set operating on the Wheatstone Bridge principle. It is designed to locate extremely

high resistance shorts, crosses and grounds, such as might occur from minute amounts of moisture in plastic insulated cable (PIC). The 4930A is connected to the cable pairs at an access point and the far-end of the cable is strapped to form a bridge configuration. Two nulling operations are performed and then either the distance to the fault, distance strap to fault or the distance to the far-end is obtained on the autoranging digital display. The 4930A includes pushbutton checks of the fault resistance, the condition of the strap as well as of its 12 V battery. A self check circuit is built into the set. The 4930A is housed in a rugged polycarbonate case. 50 Hz noise rejection and metric options are available.

4910G Open and Split Fault Locator

The 4910G is designed to provide direct distance readings to both opens and splits. An open is a discontinuity in one or both of the wires of a cable pair. Opens can be the result of bad splices as well as the result of damage caused by shotgun pellets, squirrels, gophers or shovels. A split is a splicing error in which one side of a pair is inadvertently cross-connected with one side of a second pair while the remaining sides are spliced correctly. The split is the only cable fault that is virtually always man-made. The 4910G operates on a capacitance charge sampling principle which relates the charge placed on a length of wire to its capacitance and hence its length. A built-in microprocessor performs automatically the measurements and calculations necessary to locate opens and splits. The test set averages out the effect of noise on the line by automatically taking several readings on the pair prior to displaying the fault distance on its autoranging digital display. The 4910G is set automatically for standard .083 μ f/mile exchange cable but can be reset to other types of cable by means of the D Factor control. 50 Hz noise rejection and metric options are available.

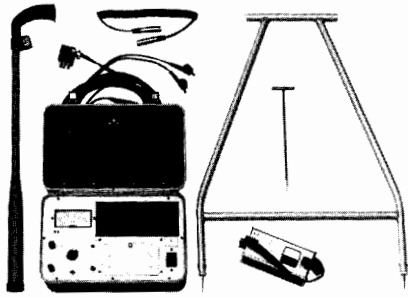

4904A



4905A

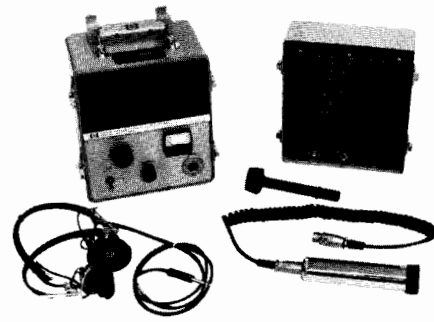

4918A



18100A

18003A

18043A

18002A

4904A Cable Fault Locator

The 4904A is a pulsed tone system that accurately locates path and depth of buried cables and pipes. It also can be used for locating shorts, crosses and grounds in aerial, underground (ducted), and direct buried utilities cable. The sensitive narrow bandwidth receiver rejects ac hum and permits locating high resistance faults. The tone transmitter unit also has a built-in ohmmeter for analyzing faults. The accessory earth contact frame is especially useful for locating high resistance pinhole faults in the cable sheathing. It comes complete with transmitter, receiver, search wand, earth contact frame, cables and ground rod. It is shipped with batteries installed.

Ultrasonic Leak Detection

The most common causes of pressure leaks in cable plant are corrosion (particularly in coastal areas), electrolysis, squirrels, boring beetles, abrasion from wind and weather, hunters, and outside workmen. Abrasion (during installation) and corrosion are the most frequent causes of cable sheath trouble in cable installed underground in ducted passages.

To detect leaks in aerial cables, the craftsman merely scans the cable from the ground with the flashlight-size microphone, listening for the characteristic hissing sounds of a leak. By simultaneously observing the level meter, he can "peak in" on the leak and determine its exact location.

4905A Ultrasonic Translator Detector

The 4905A is a lightweight, portable ultrasonic detector which includes an 18020A directional probe, focusing extension, a 6-ft. coil cord and a leather utility case. It has a self-contained speaker, a logging meter, and provision for headphones. It is shipped with batteries installed.

Pole mounted accessories are available for closer scanning of the cable and the Ultrasonic Reflector accessory is a parabolic type dish allowing exact aerial leak locating from ground level.

Leaks in ducted underground systems are located with a unique "Duct Probe" accessory.

Industrial Applications

There are many applications for ultrasonic translators other than detecting pressurized gas leaks. Using air as the conducting medium, corona discharge and arcing from electrical equipment such as transformers, insulators, and contactors can be detected. In fixed head magnetic disc memory units, the level of ultrasonic noise created by the head riding on the disc can be monitored, giving advance warning of possible "crashes."

Some applications require the use of a contact probe to pick up vibration transmitted through a solid medium. In piped steam systems the operation of steam traps, heat exchangers, and valves can be checked. Ultrasonic detection can be used for preventative maintenance on rotating mechanical equipment, and for energy loss control on heating and cooling equipment.

4918A Ultrasonic Translator Detector

The 4918A combines near-laboratory performance with field portability. It is a complete system in a rugged aluminum cabinet, listed by Underwriters' Laboratories, Inc., for use in Class I, Group D, hazardous environments. Using mercury cell batteries, the device will operate from 500 to 700 hours. Accessories can be stored in the removable cabinet cover, which is designed to fit the instrument only when the power switch is off.

This instrument is optionally available with dc recorder output. However, with this option it is not Underwriter's Laboratories, Inc. listed for use in hazardous environments.

The 4918A comes complete with headset, 18020A general purpose probe, coil cord, and focusing extension. It is shipped with batteries installed.

Accessories

18002A Quick Search Wand/18003A Mobile Reflector: when used with the Model 4905A, these accessories increase sensitivity by placing the microphone and pre-amplifier close to the cable. The 18003A is ideal for exploring high spans or long sections of cable. Isolation up to 10kV is provided with each unit for protection when exploring near power lines.

18043A Ultrasonic Reflector: this unit may be used with all ultrasonic detectors to allow location of leaks by simply scanning the cable with the gun sight mounted in the reflector. It is useful in locations where the cable can't be effectively approached with Model 18002A/18003A.

18021A Contact Probe: this contact style probe is designed for detecting conducted ultrasonic energy in lieu of radiated energy. It may be used in lieu of the 18020A general purpose probe supplied with Model 4918A.

18100A Underground Leak Location System (Duct Probe): this system, designed for use with the Model 4905A, allows pinpointing leaks in underground (ducted) cable sections. This truly unique system can save considerable money that would otherwise be wasted on hit-and-miss excavation and unnecessary cable replacement.

FDM/Carrier Systems

FDM/carrier systems are used to transmit large numbers of communications channels simultaneously over a single transmission medium, each channel being allocated a unique part of the frequency spectrum. The transmission media are generally microwave radio networks, which typically carry up to 1800 channels on each RF carrier, and coaxial cable systems, which typically carry up to 3600 channels on each coaxial 'tube'. Higher capacity systems also exist (for example, 60 MHz coaxial cable) which can carry 13,200 channels on each tube.

Each transmission spectrum is complex, containing—in addition to the communications channels—residual carriers, pilot tones, signalling and test tones which may be used to monitor the working of the system while it is actually carrying traffic.

Measurement Requirements

In the design, manufacture, installation and maintenance of FDM/carrier systems several types of measurement are necessary. Some measurements use general-purpose instruments such as network analyzers, power meters and frequency standards, but the majority of measurements require a dedicated communications selective level meter and a level generator.

HP offers a wide range of instrumentation to satisfy your measurement needs.

FDM/Carrier System Measurements

Of the many FDM measurements made, the most common are:

- Reference pilots
- Line pilots
- Channel power
- Channel noise
- Group power
- Carrier leak
- Signalling tone
- Test tone
- Supervisory tones
- Inter-supergroup noise
- Spectrum analysis
- Broadband power
- Frequency response
- Gain/loss
- Return loss
- Crosstalk

Selective Level Meter Requirements

When choosing a selective level meter (SLM), there are several criteria to consider in balancing cost and performance.

1. **Frequency Accuracy:** Ideally, tuning should be accurate and stable, using a synthesized local oscillator. This allows precise tuning to the frequency at which the measurement is to be made and, if required, remote control of the tuning.

Cost savings can be made using a free-running local oscillator, with reduced frequency accuracy and stability. This approach needs manual searching in the region of the signal and peaking the meter on the signal of interest.

2. **Sensitivity:** An SLM as well as being able to measure high level signals accurately needs enough sensitivity to measure, for example, channel noise at a low level test point. In defining measurement range, noise floor is typically the limiting factor and generally -115 dBm in 3.1 kHz is acceptable. Where greater sensitivity is required, external low-noise amplifiers may be used.

3. **Measurement Filters:** It is useful to have a selection of filters for measuring pilots and other single-frequency tones, channel power, channel noise and group power. The pilot filter should have sufficient out-of-band rejection to reject adjacent signals, for example, when measuring a channel virtual carrier leak in the presence of a group pilot. If the SLM is synthesizer-tuned and the need for "peaking" is to be avoided, then a flat top is necessary to allow for drift in the station master oscillator and the SLM between calibrations.

The channel filter should ideally have a flat top and a bandwidth equal to the voice-channel (generally 3.1 kHz). At the same time, it should have sufficient out-of-band rejection to reject adjacent channels, residual carriers and pilots, thereby ensuring an *accurate* measurement of *all* signals within the voice-channel. To make accurate noise measurements on all types of signals, a true psophometric or "C"-message weighting filter should be used with an RMS detector. Account should be taken of inverted channels, since weighting filters are asymmetric.

Cost savings can be made using the conventional 1.74 kHz effective noise bandwidth filters. The sacrifice with these is that they give the correct result only if the signals being measured are single tones or white noise. If the channel contains, for instance, VF signalling tones or data then the measurement may be in error.

The group filter is useful both in measuring the power in a group and in speeding up the search for high level users in the multiplex. In the majority of cases it is found that a high level user in one channel of a group has a sufficiently large effect on the group power to enable reliable detection with the group filter. Thus by measuring blocks of 12 channels the search is greatly speeded up.

4. **RMS versus Average Detector:** A true RMS detector always gives the correct result regardless of the composition of the signal being measured, but it is more expensive than an averaging detector. Usually the averaging detector is calibrated to give correct power measurements with sinusoidal signals and it will be in error when signals with a different spectral composition are measured. In order to overcome this, in the case of the nominal 1.74 kHz bandwidth channel filter, this bandwidth is increased to give the correct results when measuring white-noise signals.

5. **Ease of Use:** When making measurements on an FDM signal with a conventional manually-tuned SLM, the frequency of the desired pilot or channel to be measured must first be determined from the line frequency chart, a table containing several hundred frequencies. The SLM is then tuned to that frequency, its input and IF attenuators adjusted and the meter read, probably after fine tuning to peak the signal. The meter reading must be added to the attenuator settings to complete the measurement. The process is a familiar one, but time consuming and prone to error.

An alternative approach, made possible by developments in microprocessors and semiconductor memories, is to store the tables of FDM frequencies in the SLM so that, with the aid of a synthesized local oscillator, measurements may be made, with speed and confidence, directly in terms of the FDM description.

Manual Testing

The 3586A & B SLM and its companion Level Generator, the 3336A & B, are specifically designed for FDM system manufacture, installation and maintenance. The units offer state-of-the-art performance in both manual and programmable modes. The SLM local oscillator and the frequency determining circuits of the Generator utilize synthesis techniques that lead to 0.1 Hz

frequency resolution and corresponding frequency stability. The SLM offers absolute amplitude accuracy and flatness of ± 0.2 dB and Generator leveled output of ± 0.15 dB. The 3586A/3336A combination is optimized for testing to CCITT standards and the 3586B/3336B to Bell or North American standards.

The accuracy standards of these instruments are enhanced by the resolution of the SLM and the low distortion of the Generator. Filter bandwidths of 20 Hz, 400 Hz, 1.74 kHz, or 3.1 kHz, "C"-message or psophometrically weighted, are available. The 3336A/B Level Generator enjoys a harmonic distortion of -60 dB to 1 MHz and -50 dB to 21 MHz. These characteristics make the 3586A/B and 3336A/B an ideal test set for in-traffic use.

Programmability via HP-IB is standard on both instruments. The 3336A/B Generator can operate either in a stand-alone mode or track the 3586A/B SLM via the HP-IB without the need for an external controller.

The new 3746A and the 3747A/B Selective Level Measuring Sets and the 3335A/3336A/B Synthesizer/Level Generators provide an optimum solution to the problems of measurements on FDM systems for manufacture, installation and field maintenance. These selective level measuring sets each have a synthesized local oscillator, wide sensitivity range of $+20$ dBm (3746A) or $+15$ dBm (3747A/B) to -120 dBm (which is adjusted automatically), and absolute measurement accuracy of ± 0.25 dB including typical flatness of $< \pm 0.1$ dB. The measurement filters are specifically designed for FDM systems: a 38 Hz flat-topped pilot filter, a 3.1 kHz channel filter with an optional true psophometric or "C"-message

weighted noise filter and a 48 kHz group filter (optional on 3746A). True RMS detection is employed.

The sensitivity is automatically adjusted and the measurement results displayed on a digital LED display. CCITT and Bell frequency plans are stored in memory thus tuning is effected simply by keying in Channel, Group, Supergroup number, etc.

Several automatic routines are also accessible from the simple keyboard. Examples are scans of pilots, channel power, group power, carrier leak and inter-supergroup noise. These sets can also measure broadband power and, optionally, phase jitter, weighted noise and noise-with-tone. Additionally, the 3746A can measure single-level impulse noise (by option). The 3746A standard unit includes an Access Switch Controller (similar in capability to the 3755A Switch Controller), a Frequency Counter and a non-volatile Real-time Clock.

Automatic Testing

Hewlett-Packard manufactures a wide range of HP-IB automatic system components. These make the implementation of automatic system ideas relatively straight forward from both the hardware and software standpoints. HP-IB systems make automatic testing more economically justifiable.

The 3046A/B is a low cost automatic FDM Surveillance System built around the 3586A/B SLM and 3336A/B Level Generator. The HP 85F Personal Computer is used as system controller, combining powerful control and computational capabilities in a lightweight, easy-to-use package. The system has stored FDM plans and the ability to automate virtually all system measurements, including pilot scans, channel power and slot noise. The system is very flexible, allowing

automatic sequential tests, voice channel impairments vs time, or spot frequency measurements. Results can be listed tabularly or plotted using the 85F's powerful graphics capability and internal printer. Measuring automatically with the 3046A/B is as easy as answering a series of simple questions. This ease-of-use, along with the low cost of the system, make the 3046A/B an ideal way to bring automation to your FDM system.

The majority of the above facilities are provided on the 3746A SLMS, without the need for an external controller, and with faster measurement speed. For even greater capability, the 3746A and 3747A/B SLMS's can be remotely controlled through the HP-IB from a suitable controller such as the 85F Personal Computer, the 9826A Desktop Computer or the HP 1000 Computer System. This facilitates building a range of measurement systems from, for example, a single-instrument automatic, production test system to a fully automatic, multi-station, remote surveillance system. SLMS systems based on the 3747A/B and the 3746A's predecessor (the 3745A/B) are already providing comprehensive automatic measurement capability on FDM networks in many countries throughout the world.

An integral part of both large and small surveillance systems is a means of both connecting test points to the measuring set and connecting test signals to appropriate test inputs. This access switching is provided by the 3754A, 3756A and 3757A Switches which are controlled by a Switch Controller. In the case of 3747A/B and 3046A/B systems, the switch control function is provided by a 3755A Switch Controller. With 3746A systems, the switch control function is included within the SLMS. In either case, manual or remote control is possible.

Summary of Selective Level Meters

	3586A 3586B	3746A	3747A 3747B
Frequency Range	50 Hz to 32 MHz	50 Hz to 32 MHz	10 kHz to 90 MHz
Level Range	+20 to -120 dBm	+20 to -120 dBm	+15 to -120 dBm
Detector	RMS	RMS	RMS
Filters	20 Hz 400 Hz 1.74 kHz/2.0 kHz 3.1 kHz* Psophometric or "C"-Message weighted* Notch filters*	22 Hz 3.1 kHz 48 kHz* Psophometric or "C"-Message weighted* 2.5 kHz* Notch filters*	22 Hz 3.1 kHz 48 kHz Psophometric or "C"-Message weighted* 2.5 kHz* Notch filters*
Broadband Power	Yes	Yes	Yes
Phase Jitter	Yes*	Yes*	Yes*
Impulse Noise	Yes*	Yes*	No
S/N With Tone	Yes*	Yes*	Yes*
Scanning	Manual†	Automatic	Automatic
Companion Level Generator	3335A (32 MHz) 3336A/B (21 MHz)	3335A (32 MHz) 3336A/B (21 MHz)	3335A

*Optional—refer to specifications †Automatic with external controller



TELECOMMUNICATIONS TEST EQUIPMENT

Selective Level Measuring Sets

Models 3746A, 3747A, 3747B

- Frequency range 50 Hz to 32 MHz
- Selective filters for pilot, channel and (optionally) group power measurements
- Auto-ranging attenuators and automatic tuning to stored frequency plans
- Out-of-limits alarm with hard-copy record on separate printer
- Automatic routines for unattended measurements
- Built-in access switch controller, real-time clock and frequency counter
- Ideally suited to HP-IB systems applications

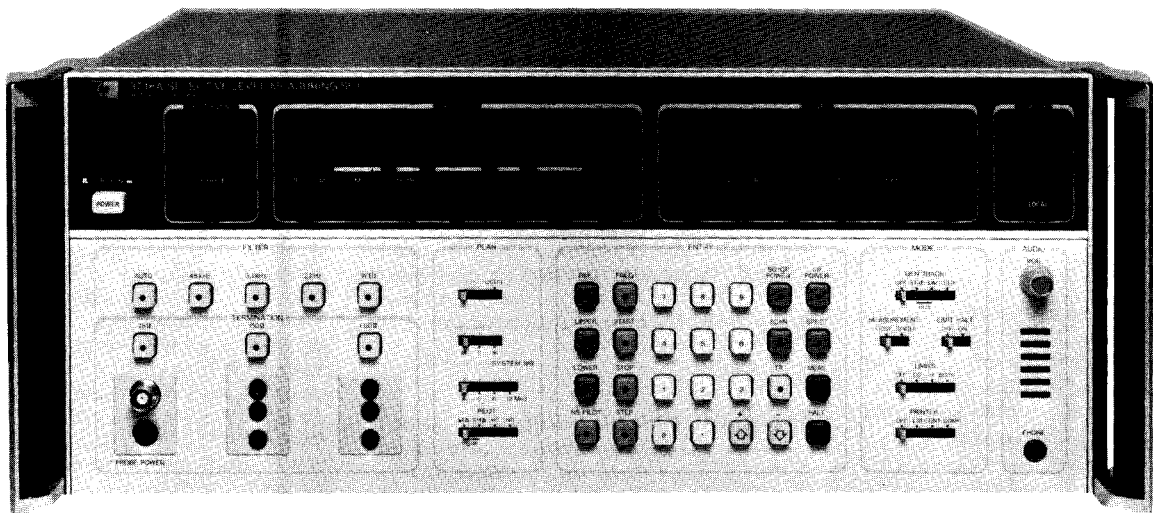

3746A



3746A Selective Level Measuring Set

The 3746A Selective Level Measuring Set (SLMS) is designed to make fast, accurate selective level measurements. A built-in frequency synthesizer gives accurate, stable tuning to the precise frequency at which the measurement is to be made. The 3746A can be tuned over its frequency range (50 Hz to 32 MHz) with a resolution of 1 Hz.

The SLMS measures true rms power between +20 dBm and -120 dBm with 1 dB, 0.1 dB, or 0.01 dB resolution. Fully auto-ranging attenuators and amplifiers simplify operation further by eliminating the need to set attenuators and add meter readings. Measurement results are automatically displayed to the selected resolution, in dBm or dB relative terms, on an LED display. The absolute accuracy of the measurement over wide level and temperature ranges is $< \pm 0.25$ dB including a flatness variation of typically $< \pm 0.1$ dB.

Many benefits are derived from the purpose designed filters contained in the SLMS. The 38 Hz pilot filter has a flat top over 22 Hz, necessary for automatic tuning, and achieves high out-of-band rejection so that, for example, carrier leak and adjacent pilots can be measured on active systems. The channel filter is a flat-topped 3.1 kHz filter which can be used for measuring all signals in the voice channel. It provides high out-of-band rejection, thus ensuring that pilots, residual carriers, signalling tones, etc, do not interfere with measurements. Optional weighted filters are available to make either true 'C'-message or CCITT psophometrically weighted noise measurements. These options, in addition to providing a weighted filter, give the following voice channel impairment measurements: single level impulse noise, phase jitter on a 1 kHz channel test tone (3 measurement bandwidths) and noise-with-tone measurement. A 48 kHz filter for group power measurements is available by option to facilitate fast location of high level signals on a multiplex. Using the 48 kHz group filter the SLMS can also perform supergroup power measurements by evaluating automatically the logarithmic average of the 5 group powers in a supergroup. This measurement is useful for assessment of system loading.

The 3746A is internally controlled by a microprocessor which provides many ease-of-use and time-saving features. As well as tuning exactly to an entered frequency, the SLMS can refer to CCITT or Bell multiplex frequency plans in its memory and automatically tune to the correct frequency at any level in the multiplex. Other frequency plans, as used for example on submarine cable or satellite links, can be installed to special order. In cases where operation on a large number of non-standard plans is required, it is possible to down-load each FDM plan from an external controller (for example a desktop computer). FDM plans are thus available to the SLMS processor from fixed memory (ROM) or dynamic memory (RAM). Two additional user-accessible storage areas are available: the random frequency and FDM skip registers. The random frequency registers permit the storage, either from the keyboard or under remote control, of up to 145 unrelated frequencies. The SLMS can then be programmed to scan through these frequencies, at the same speed as if an FDM plan were being scanned. The FDM skip registers give the capability of specifying up to 30 areas of FDM plan where no measurements are to be performed. This facility is useful when, as often happens, the multiplex is not fully loaded—it is then possible to miss out non-significant measurements on, for example, an unloaded supergroup. The storage of user-defined FDM plans, FDM skips, and random frequencies is non-volatile—if line power is lost the stored data is preserved for several hours by internal battery back-up. The comprehensive FDM plan and frequency storage capability of the SLMS eliminates the need for the operator to refer to FDM plan charts and tables. The SLMS can automatically step through pilots and supervisory tones, channels, group powers, carrier leaks, etc, across the baseband of a multiplex—comparing levels with pre-determined alarm limits and providing a print-out of limit violations on a separate printer. 250 pilot measurements can be made in about 2 minutes and 2700 channel powers can be measured in about 6 minutes. Spectrum analysis measurements of a voice channel, group, supergroup, or even the whole baseband can also be made. Measurements can be made unattended, for example, overnight.

TELECOMMUNICATIONS TEST EQUIPMENT

Selective Level Measuring Set (Cont.)

Models 3746A, 3747A, 3747B

619

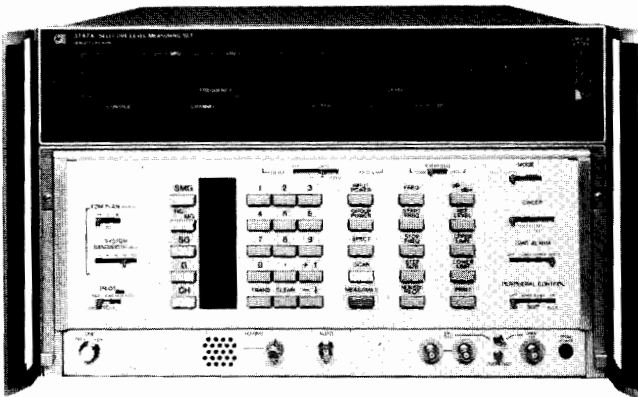

3747A (CCITT)

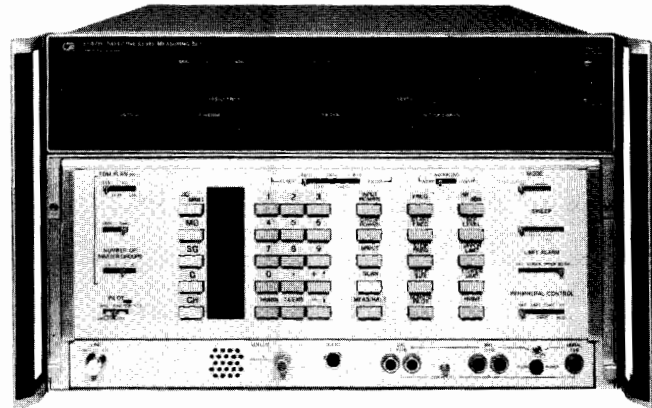

3747B (Bell)

3746A (Cont.)

In addition to its extensive selective level measurement capabilities, the 3746A offers several additional functions. Control of test point selection is provided by means of a built-in Access Switch Controller. This performs a function similar to the 3755A Switch Controller: control of 3754A, 3756A, or 3757A Switches to select 1 from a possible 10 RF outputs. Up to 111 Switches can be cascaded under control of a single 3746A to allow selection of 1 from up to 1000 RF outputs. A 3-digit display on the SLMS front panel indicates the selected port. Another useful feature is the SLMS's integral Real-time Clock which can display time or date and holds the correct time even when the SLMS is switched off. If a printer is connected to the 3746A via the HP-IB, the SLMS can be configured to output measurement results to the printer together with the date and time at which each measurement is made. The SLMS also incorporates a Frequency Counter which can be used to count the frequency of an incoming signal. The SLMS can then re-tune and capture the signal, provided the signal lies within the 60 dB bandwidth of the selected filter.

The 3746A is fully programmable via the HP-IB, and can itself assume the role of system controller. In this mode, selectable by a rear panel switch, the SLMS can control a tracking Frequency Synthesizer (models 3330B, 3335A, and 3336A/B are compatible), a 20- or 80-column Printer (for example, 5150A or 2631B), and a CRT Display. It is thus possible to assemble a self-contained test station for network maintenance and surveillance. For more powerful, fully automatic surveillance applications, the SLMS can be switched to its remote mode and controlled via the HP-IB from an external controller (for example, a desktop or mini-computer). In multiple SLMS systems, where the instruments are controlled via HP-IB Extenders and a modem link, the storage of FDM plans and limits within the 3746A minimizes the interaction between controller and SLMS to give optimum system efficiency.

Options

- 001: Siemens series 1.6/5.6 mm 75Ω connectors
- 005: WECO 477B/223A (equivalent) connectors
- 011: 48 kHz group filter
- 013: high stability frequency reference
- 015: channel impairments—CCITT
- 016: channel impairments—North America
- 907: front handle kit
- 908: rack flange kit
- 909: rack and handle kit
- 910: extra set of manuals
- 3746A Selective Level Measuring Set**

Prices

- N/C
- add \$109
- add \$1060
- add \$1005
- add \$645
- add \$645
- add \$47
- add \$37
- add \$74
- add \$100
- \$18070**

3747A/B Selective Level Measuring Set

The 3747A and 3747B Selective Level Measuring Sets (SLMS's) are designed to make selective level measurements over the frequency range 10 kHz to 90 MHz. Many of the original concepts in these instruments are incorporated in the newer 3746A 32 MHz SLMS. The 3747A and 3747B SLMS's include an accurate, stable frequency synthesizer, and fully auto-ranging measurement of true rms power between +15 dBm and -120 dBm with better than ±0.25 dB accuracy over wide level and temperature ranges. The SLMS's provide a complete set of purpose-designed filters for pilot, channel, and group power measurements. Optional channel filters are available for psophometric (3747A) or C-message (3747B) weighted noise measurements or for measurements over 2.5 kHz bandwidth on multiplex systems with 16-channel group structure.

Internally stored multiplex frequency plans in the SLMS memory give the capability of automatic scanning through all levels of the multiplex. The 3747A provides all the CCITT plans up to 60 MHz, while the 3747B provides all the North American (Bell) plans up to 65 MHz. Other FDM plans, such as those used on high capacity submarine cables, can be supplied to special order.

The 3747A and 3747B SLMS's provide user-defined limits storage—measurements which fall outside these limits can be output via the HP-IB to an external Thermal Printer. Bus connection of an external tracking Frequency Synthesizer is also possible (models 3330B and 3335A are compatible). For a graphical plot or display of measurement results, analog X, Y and Z outputs are available by option on the SLMS rear panel.

The SLMS's are fully programmable via the HP-IB and so can form the basis of a powerful, fully automatic surveillance system.

Options

- 001: Siemens series 2.5/6 mm 75Ω connectors N/C
- 002: Siemens series 1.6/5.6 mm 75Ω connectors N/C
- 004: WECO 560A/562A/223A (equivalent) connectors N/C
- 021: phase jitter + psophometric weighted filter add \$295
- 022: phase jitter + C-message weighted filter add \$295
- 023: psophometrically weighted noise + tone add \$320
- 024: C-message weighted noise + tone add \$320
- 025: 2.5 kHz channel filter add \$590
- 040: X-Y recorder/display driver add \$1150
- 908: rack flange kit add \$53
- 910: extra set of manuals add \$105

Prices

Ordering Information

- 3747A Selective Level Measuring Set (CCITT) \$32805
- 3747B Selective Level Measuring Set (Bell) \$32805

TELECOMMUNICATIONS TEST EQUIPMENT

Access/Distribution Switches and Controller (8.5 MHz, 25 MHz, 90 MHz)

Models 3754A, 3755A, 3756A, 3757A

- Select 1 from a possible 10 RF Inputs/Outputs
- Cascade several Switches to allow selection from 1000 Inputs/Outputs
- Mix different Switches for the most cost-effective solution
- Single 3755A can control 111 Switches from a simple keyboard
- Remote input selection using HP-IB
- 75Ω termination of unselected ports



3754A

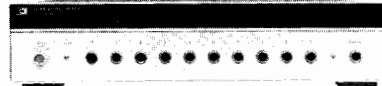

3756A



3757A

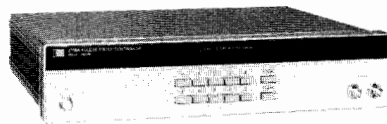

3755A

The 3754A, 3756A and 3757A Switches and the 3755A Controller have been developed to meet the requirements of three main areas.

1. Frequency Division Multiplex (FDM) System surveillance and maintenance—the Controller/Switch combination is used in conjunction with a Selective Level Measuring Set (SLMS), such as the 3746A (32 MHz) or 3747A/B (90 MHz), to monitor pilot and traffic levels at various points in the multiplex without manually connecting the SLMS to each point.
2. Production testing—where automatic selection of several RF signals is required.
3. Data logging—where large numbers of RF signals need to be accumulated at one control point.

3754A 25 MHz Access Switch

The 3754A 25 MHz Access Switch is an ac-coupled, uni-directional, ten-input switch with a frequency range from 10 kHz to 25 MHz. The 3754A incorporates a virtual-ground amplifier—giving an insertion loss of $< \pm 0.1$ dB from 50 kHz to 20 MHz and high isolation across the whole frequency range. The isolation between any unselected input and the output is > 85 dB and the isolation between any two inputs is > 90 dB. In addition, pre-set gains of 1, 2 and 3 dB are internally selectable to compensate for losses in cables and equalizers. (The 3754A can be powered from the ac mains or from a dc supply.)

3756A 90 MHz Bi-directional Switch

The 3756A 90 MHz Switch is a dc-coupled, bi-directional, ten-way switch with a frequency range from dc to 90 MHz. The 3756A offers isolation of > 80 dB between channels, and > 75 dB between unselected input and output ports. It has an insertion loss of 1 dB with a flatness of $< \pm 0.2$ dB and > 28 dB return loss. (The 3756A can be powered from the ac mains or from a dc supply.)

3757A 8.5 MHz Access Switch

The 3757A 8.5 MHz Access Switch is a low-cost, ac-coupled, uni-directional, ten-input switch with a frequency range of 10 kHz to 8.5 MHz. An option provides expanded frequency range from 200 Hz to 8.5 MHz. The 3757A has an insertion loss < 0.1 dB from 10 kHz to 4 MHz and isolation of > 95 dB between channels. In addition, pre-set gains of 1, 2 and 3 dB are internally selectable to compensate for losses in cables and equalizers. (The 3757A is powered from a ± 15 V dc supply.)

3755A Switch Controller

The 3755A Switch Controller has a small, easy-to-operate keyboard with a 3-digit LED display to denote the input or output selected. Each Switch (3754A, 3756A or 3757A) is given a 1-digit code, to select the required port. In a large Switch network, involving 3 levels of cascaded Switches, selection from up to 1000 inputs or outputs is possible. This requires a 3-digit code (000 to 999) where each digit represents the input or output of the appropriate Switch at each of the 3 levels.

Because the 3755A is a self-contained unit, separate from the Switches, it is possible to locate the Switches remotely from the Controller. In the case of the 3754A and 3757A, the control signal can be transmitted over the same cable as the RF signal. This eliminates the need for separate control cables and makes inter-connection changes easier. Sending control signals over the RF path has no effect on the RF signal source. (The 3755A is powered from the ac mains.)

The control signals can also be sent along a separate two-wire path. This is necessary for the 3756A or when the continuous dc path between the Switches and Controller is interrupted, for example, by an ac-coupled equalizer inserted to compensate the line-frequency response.

A combination of both methods of control signaling can be employed in the same Switch system. Also, if necessary, high and low frequency Switches can be incorporated into the same system.

HP-IB Control

The 3755A Switch Controller can be remotely controlled over the Hewlett-Packard Interface Bus (HP-IB) by a desk-top computer. Selection of the RF input/output to be accessed is achieved using a 3-digit code that defines the particular input/output required. Since it is the 3755A which is controlled via the HP-IB, only one bus address is used for up to 111 Switches.

Ordering Information

	Price
3754A 25 MHz Access Switch	\$2615
3755A Switch Controller	\$2780
3756A 90 MHz Bi-directional Switch	\$3340
3757A 8.5 MHz Access Switch	\$1115

TELECOMMUNICATIONS TEST EQUIPMENT

Access/Distribution Switches and Controller (8.5 MHz, 25 MHz and 90 MHz) (Cont.)

Models 3754A, 3755A 3756A and 3757A



Specifications

Parameter	3754A 25 MHz Access Switch	3755A Switch Controller	3756A 90 MHz Bi-directional Switch	3757A 8.5 MHz Access Switch
Frequency Range	10 kHz to 25 MHz	-	dc to 90 MHz	10 kHz to 8.5 MHz 200 Hz to 8.5 MHz (Opt 200)
Insertion Loss	<±0.1 dB (50 kHz to 20 MHz) <±0.3 dB (10 kHz to 25 MHz)	<0.1 dB (I/P & O/P on rear) <0.2 dB (I/P & O/P on front)	1 dB ± 0.15 dB, dc to 80 MHz 1 dB ± 0.3 dB, 80 to 90 MHz	0 dB ± 0.1 dB (10 kHz to 4 MHz) 0 dB ± 0.2 dB (10 kHz to 8.5 MHz) 0 dB ± 0.5 dB (200 Hz to 10 kHz — Opt 200)
Pre-set Gain	0 dB 1 dB ± 0.1 dB 2 dB ± 0.1 dB 3 dB ± 0.1 dB (75Ω only)	-	-	1 dB ± 0.03 dB 2 dB ± 0.03 dB 3 dB ± 0.03 dB
Isolation	>85 dB (between I/P & O/P) >90 dB (any two inputs)	-	>75 dB (between I/P & COMMON) >80 dB (any two unselect- ed inputs)	>70 dB (any I/P & O/P over 10 kHz to 8.5 MHz) >75 dB (any I/P & O/P over 10 kHz to 4 MHz or 20 Hz to 10 kHz — Opt 200) >95 dB (any two adjacent inputs 10 kHz to 8 MHz) >105 dB (any two adjacent inputs 10 kHz to 4 MHz or 200 Hz to 10 kHz — Opt 200)
Return Loss	>30 dB (selected I/P from 60 kHz to 25 MHz) >23 dB (unselected I/P from 60 kHz to 25 MHz) >30 dB (output from 60 kHz to 25 MHz)	>30 dB (rear panel from 60 kHz to 25 MHz)	≥24 dB (output, dc to 80 MHz) ≥20 dB (output, 80 to 90 MHz) ≥28 dB (ports 0 to 9, dc to 80 MHz) ≥20 dB (ports 0 to 9, 80 to 90 MHz)	>35 dB (selected I/P from 10 kHz to 8 MHz) >35 dB (unselected I/P from 10 kHz to 8 MHz) >35 dB (output from 10 kHz to 8 MHz)
Overload Level	0 dBm (control over signal path) +10 dBm (control over separate path) +8 dBm (50Ω version only)	-	-	0 dBm
Maximum Ac Input Power	+25 dBm (at each input)	-	+25 dBm (at each input)	+25 dBm (at each input)
Noise Power Ratio (Typical)	>70 dB (-10 dBm over any 8 MHz band)	>70 dB (-10 dBm over any 8 MHz band)	-	>50 dB (-10 dBm Input from 60 kHz to 8 MHz) >58 dB (-10 dBm Input from 60 kHz to 4.1 MHz)
Thermal Noise (in 3.1 kHz bandwidth)	<-115 dBm (from 60 kHz to 300 kHz) <-120 dBm (from 300 kHz to 25 MHz)	-	-	<-119 dBm (60 kHz to 4.1 MHz) <-117 dBm (60 kHz to 8.5 MHz) <-100 dBm (300 Hz to 3.4 kHz — Opt 200)

General

Power	3754A	3755A	3756A	3757A		
Input Voltages (ac)	100, 120, 220, 240 V	100, 120, 220, 240 V	100, 120, 220, 240 V	-		
Tolerance	± 10%	± 10%	± 10%, -15%	-		
Consumption	<20 VA	<20 VA	<20 VA	-		
Frequency	48 to 66 Hz	48 to 66 Hz	48 to 66 Hz	-		
OR						
Input Voltages (dc)	± 15 V	-	+15 V	20 V		
Tolerance	± 2%	-	± 2%	± 5 V		
Nominal Current	150 mA (-15 V) 300 mA (+15 V)	-	200 mA	100 mA		
Ripple	<5 mV pk-pk	-	5 mV pk-pk	<5 mV pk-pk		
Weights						
Net	6 kg (13 lb)	5 kg (11 lb)	6 kg (13 lb)	1.7 kg (3.75 lb)		
Shipping	11 kg (24 lb)	12 kg (26 lb)	11 kg (24 lb)	4 kg (7.5 lb)		
Size						
Width	425 mm (16.8 in)	425 mm (16.8 in)	425 mm (16.8 in)	483 mm (19 in)		
Height	89 mm (3.5 in)	89 mm (3.5 in)	89 mm (3.5 in)	44 mm (2 in)		
Depth	350 mm (13.9 in)	350 mm (13.9 in)	350 mm (13.9 in)	260 mm (10 in)		
Options	Front	Rear	Front	Rear	Front	Rear
BNC (75Ω)	STD	010	STD	-	STD	010
Siemens Series						
2.5/6 mm (75Ω)	001	011	001	-	001	011
Siemens Series						
1.6/5.6 mm (75Ω)	002	012	002	-	002	012
BPO Type IE (75Ω)	003	013	003	-	-	-
Commercial equivalent of WECO Type 560 A (75Ω)	004	014	004	-	004	014
Commercial equivalent of WECO Type 477B (75Ω)	005	015	005	-	005	015
BNC (50Ω)	006	016	006	-	-	-
Suhner J-Type (75Ω)	-	-	-	-	007	017

TELECOMMUNICATIONS TEST EQUIPMENT

FDM Network Surveillance System Software

Models 37013A, 37014A



Introduction

Hewlett-Packard offers remote-surveillance systems for use with Frequency Division Multiplex (FDM) networks. There are two basic types of system available, the choice being made according to the size of the FDM network and the network management requirements.

37013A System Software

The 37013A FDM Network Surveillance System Software is designed to provide a comprehensive solution to the problems associated with performance monitoring of a complex and widely-spaced FDM network. The 37013A Software, together with the necessary control and measurement hardware, forms a complete automatic measurement system for use in the commissioning, surveillance, fault finding and maintenance of FDM installations.

The system operates under the direct control of a central HP 1000 Computer, which gathers measurement information from up to 16 remote stations simultaneously. A 3745A/B or 3747A/B Selective Level Measuring Set (SLMS) forms the basis of each station.

Capability of the 37013A

The 37013A Software provides a full range of automatic surveillance measurement sequences, together with the ability to print out, or store for future analysis, all measurement results. Also provided are demand programs used to make measurements under the direct control of an operator. Access to the computer may be gained from any desired location using a suitable terminal connected via modems and a dialled-up or dedicated telephone line.

The ease with which information about the FDM network can be collected and processed enables performance trends and management reports to be assembled with a minimum of effort.

Trend Analysis

The analysis of long-term trends in the network allows performance degradations to be found, and the necessary maintenance undertaken before any serious problems develop. This can reduce radically the time during which the network is inoperative if major failures have to be first diagnosed and then repaired.

When failures do occur, the ability to localize the fault quickly and accurately is of paramount importance. The 37013A Software can be configured to monitor continuously specific test points throughout the network. If a problem then arises somewhere between stations, a message is output directly onto an operator terminal allowing immediate action to be taken.

Management Reporting

The extensive data base which is a part of the 37013A Software

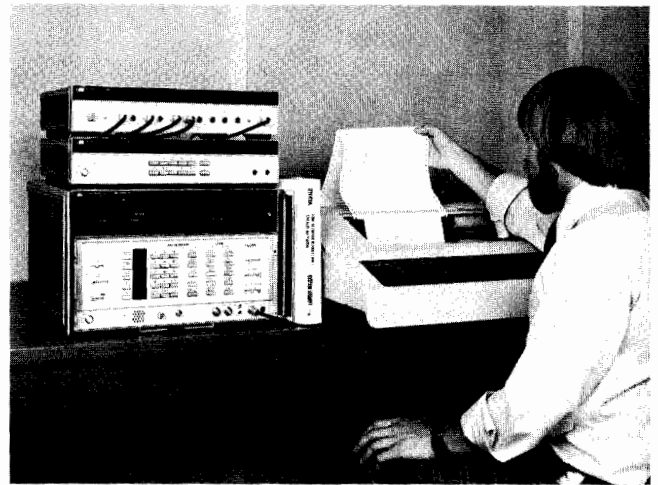

forms an ideal base for the preparation of management reports. Information about the network obtained over a long period can be extracted from the data base by the HP 1000 Computer. This data forms a concise and convenient basis for management reporting.

Measurement Hardware—The Heart of the System

The 37013A FDM Network Surveillance System is based on the 3745A/B and 3747A/B SLMS's. These instruments, with the addition of the HP 1000 Computer, become the heart of a powerful automatic measurement system.

Switching between test points is achieved with the 3754A, 3756A or 3757A Switches controlled by the 3755A Switch Controller. Test signals are generated by the 3335A Synthesizer/Level Generator. All the instruments forming a measurement station are controllable from the HP-IB.

Communication between stations is achieved over full duplex, dedicated telephone lines, with conversion of the parallel HP-IB information to an RS-232C compatible serial data form suitable for transmission through voice channel modems.

System Software—The Power of the 37013A

The 37013A FDM Network Surveillance System Software consists of system functional tests, a system diagnostic and measurement programs.

The system functional tests are designed to verify, as fully as possible, that the instruments at a station function correctly. The diagnostic routine is intended to aid the user in identifying a fault condition in the system.

Measurements can be made in either of two modes; automatic measurements, or measurements on operator demand at any time.

Automatic measurements are made under the control of the "SFDM" program and consist of a sequence of surveillance-type measurements such as group pilots, virtual carriers, channel powers, etc. Measurements are made without operator intervention, apart from initiation, and sequences may be strung together so that the system proceeds to the next and subsequent sequences automatically.

An operator works interactively with demand measurement programs, entering simple requests on a terminal to initiate spot tests such as single point frequency, input power and FDM scan.

Information about each test point connected to the system is stored in the station data base, which can also be used to store measurement results. The stored results may be used as the basis of network management reports.

HP's distributed operating system DS1000 can be incorporated if required, enabling several distant computers to be interconnected, thereby expanding the monitoring capability.

Documentation

Full documentation is provided in the form of the 37013A System Library, which includes information on integrating the system hardware, entering details of the FDM network into the data base, running "SFDM" and the demand measurement programs, and using the System Functional Test and Diagnostic programs. The System is supplied on an HP disc cartridge, ready for immediate use on the HP 1000 Computer.

TELECOMMUNICATIONS TEST EQUIPMENT

FDM Network Surveillance System Software

Models 37013A, 37014A

623



Support Services

A full training course on the use of the Surveillance System is available from Hewlett-Packard, along with an equipment verification service whereby the computer, the instrumentation and the software are assembled, and correct operation is verified.

All the individual components that make up the Surveillance System are designed and manufactured by Hewlett-Packard and are backed up by HP's worldwide support. 37013A is in use around the world, providing valuable service to FDM network operators.

Ordering Information

The 37013A FDM Network Surveillance System Software consists of the Disc Cartridge for the HP 1000 Computer, the documentation in the system library, and a diagnostic kit for use with the System Functional Test and Diagnostic programs. The HP 1000 Computer and all other instrumentation must be ordered separately. For further information on the equipment required, and on the capability of the 37013A Software, see the 37013A data sheet or contact your local Hewlett-Packard representative.

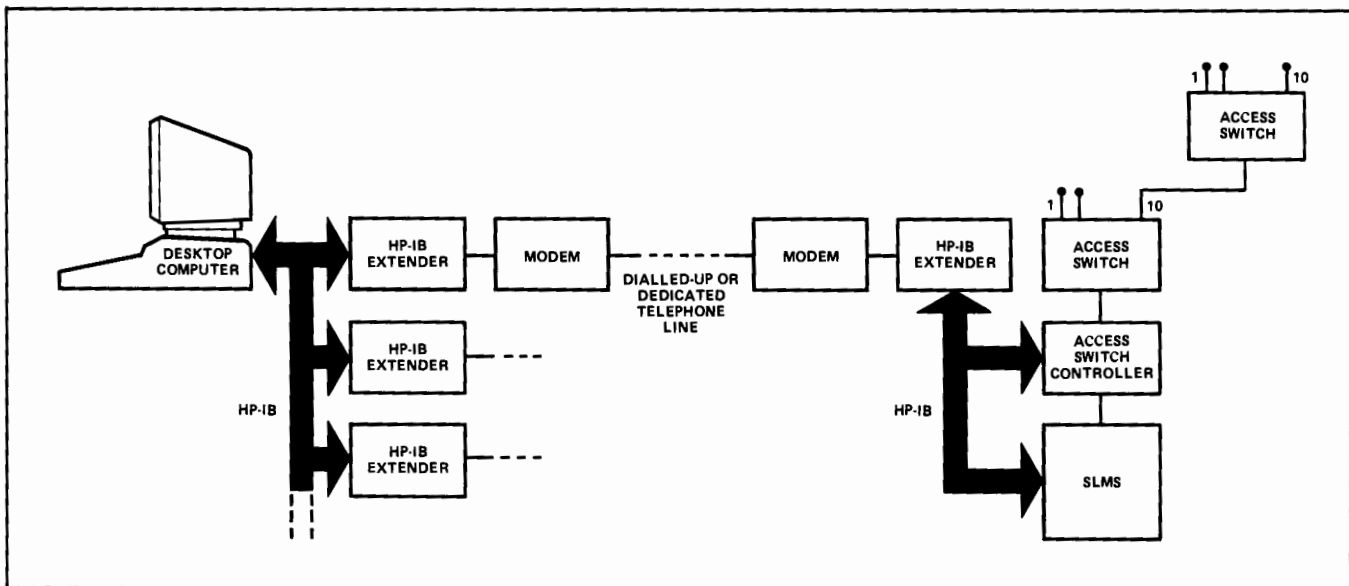

37014A configuration for multiple point-to-point operation

37014A System Software

The 37014A FDM Network Surveillance System Software is designed to provide a cost-effective system for monitoring the performance of an FDM network.

Description

The 37014A Software provides for a number of measurement stations controlled from a 9835A Desktop Computer. Each station is based upon 3745A/B and 3747A/B SLMS's, with the 3754A, 3756A or 3757A Switches used to access test points under the control of the 3755A Switch Controller.

Point-to-point, Multi-drop or Dial-up operation over telephone lines is achieved using the 37201A HP-IB Extender and suitable voice channel modems. All the instruments forming a measurement station are controllable from the HP-IB.

The 37014A Software can control several remote measurement stations one-at-a-time. Up to six such stations can be handled with ease this way. In the absence of controller activity, the semi-automatic capabilities of the 3745A/B and 3747A/B may be utilized in each location.

System Software—The Versatility of 37014A

The 37014A System Software comprises system functional test programs and measurement programs.

The system functional tests are designed to verify, as fully as possible, that the instruments at a station function correctly.

The measurement programs enable the Desktop Computer to acquire the results of measurements made by an SLMS at any one station in the network. Measurement routines such as group pilot scan group power and channel noise can be assembled in any order into an automatic surveillance sequence. Additionally, interactive demand programs are provided, enabling measurements to be made at any time under the direct control of an operator. Typically, demand measurements may be used to investigate problems found by the automatic routines, or to aid in the commissioning of new links.

The software includes a data base containing details of each test point in the network. This data is used by the system functional tests and the measurement programs, both of which require information on the FDM hierarchy, the test level at each point, and the configuration of each station.

Documentation and Ordering Information

The 37014A FDM Network Surveillance System Software consists of a 9835A Data Cartridge, a System Library and a diagnostic kit for use with the system functional tests. The 9835A Desktop Computer and all other instrumentation must be ordered separately.

The 37014A System Library includes information on integrating the system hardware, entering details of the FDM network into the data base and running the system functional test and measurement programs.

TELECOMMUNICATIONS TEST EQUIPMENT

Selective Level Meter and Synthesizer

Models 3586A/B & 3336A/B

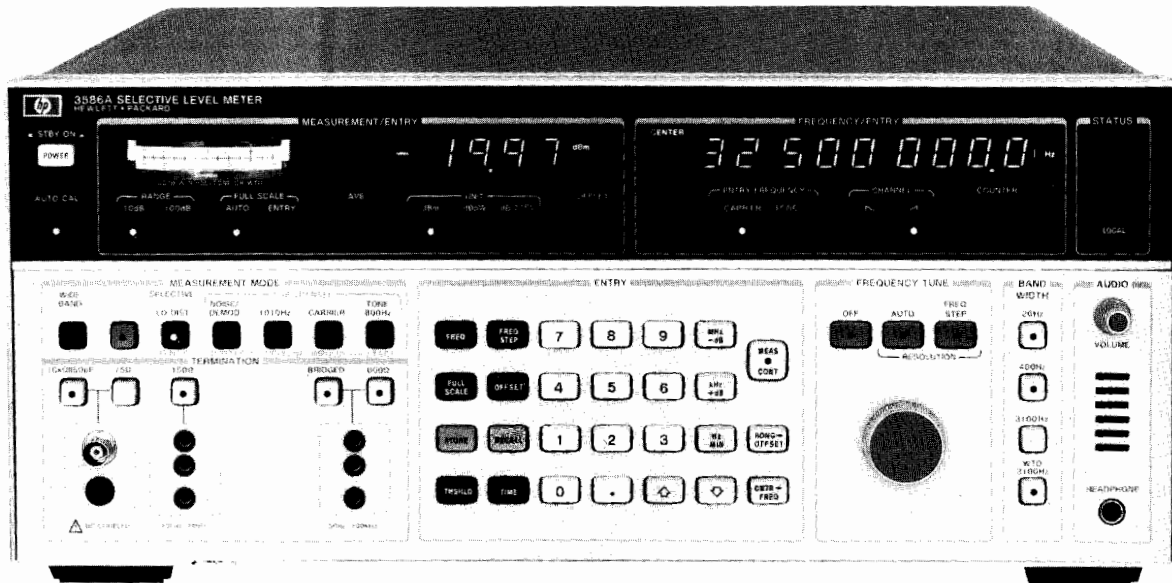

3586A Selective Level Meter (CCITT) (Shown with Opt 003)

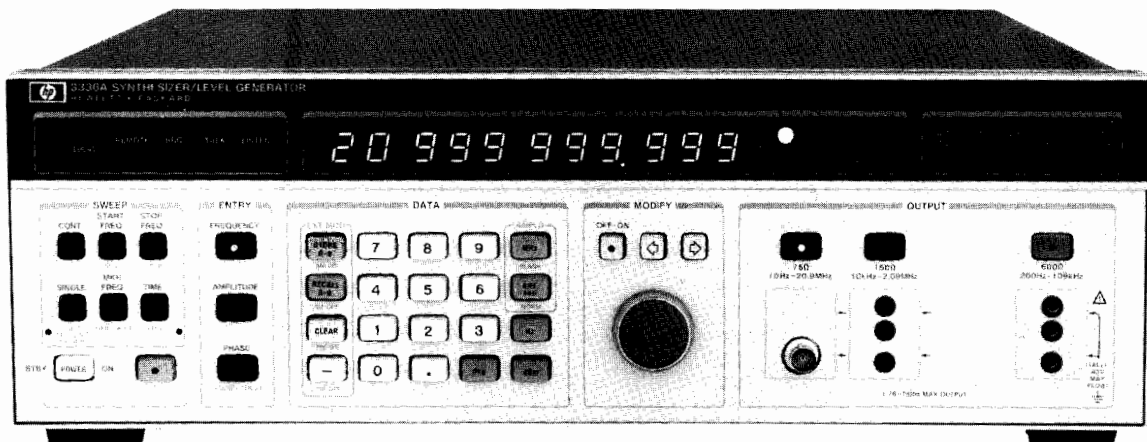

3336A Synthesizer/Level Generator (CCITT)

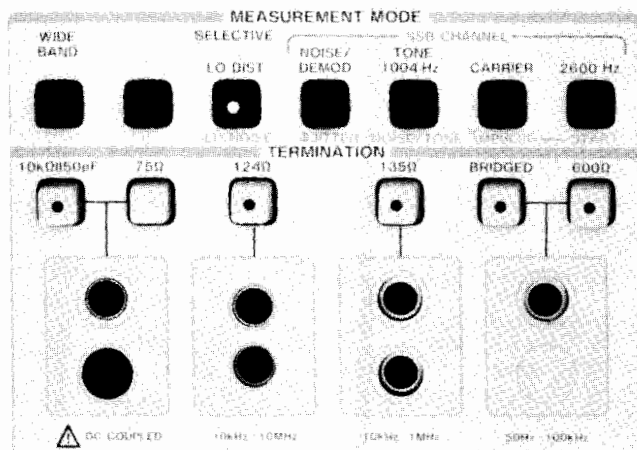

Measurement Mode Section, 3586B Selective Level Meter, North American (BELL) (Shown with Opt 003)



Description

General

Hewlett-Packard's new 3586A/B Selective Level Meters and 3336A/B Tracking Synthesizers offer the high performance necessary to meet the demanding requirements in the design, manufacture, commissioning and maintenance of Frequency Division Multiplex (FDM) systems. The 3586 and 3336 "A" models meet CCITT requirements, and the "B" models meet North American (Bell) standards. Both are fully programmable over the HP Interface Bus. The 3586A & B Selective Level Meter provides a unique combination of features, including wideband power and optional telephone impairment measurement of impulse noise, phase jitter, noise with tone, and signal-to-noise with tone ratio. The 3586A & B's wide frequency coverage to 32.5 MHz allows measurements to be made at both voice channel and carrier frequencies. Microprocessor control adds many ease-of-use features such as amplitude offset measurements of tone and noise level in units of dBmO, dBmCO, or dBpWO. Convenience features include simultaneous analog and digital level

displays, precise frequency setting with HP's fractional N synthesized local oscillator, accurate frequency counter and tone measurements with automatic channel alignment for 800 Hz (CCITT) or 1004 Hz (Bell) test tone or carrier frequency reference.

Carrier Frequency and Voice Channel

The 3586A & B can make both carrier frequency measurements to 32.5 MHz and voice channel measurements from 50 Hz to 100 kHz.

You can measure tone levels, idle channel noise or weighted noise at voice channel, then compare at carrier frequency. Level measurements can be made with ± 0.2 dB accuracy up to 18 MHz and down to -80 dBm. The built-in frequency counter can be used to measure frequency within ± 1.0 Hz and 0.1 Hz resolution. When using the 20 Hz bandwidth to measure pilots accurately, an adjacent carrier leak will be rejected by 50 dB.

Transmission Impairments (Optional)

The Transmission Impairments Option 003 permits phase jitter, weighted noise, noise-with-tone, signal-to-noise-with-tone ratio, and single level impulse noise measurements. The 3586A's capability to make these transmission impairment measurements at both FDM voice channel and carrier frequencies is unique.

Standard models include a 1740 Hz psophometric (CCITT) or 2000 Hz C-message (Bell) equivalent noise filter or you can make weighted noise measurements directly with the 3100 Hz channel filter and noise weighting filter provided with the Transmission Impairments Option 003. The channel filter shape factor of < 1.2 provides 60 dB carrier and 75 dB adjacent channel rejection and synthesizer accuracy aligns it perfectly—you know you're measuring only that channel.

Precision Frequency Setting

Synthesizer accuracy and resolution is made possible with a fractional-N synthesized local oscillator—a unique HP development. 0.1 Hz resolution and $\pm 1 \times 10^{-5}$ /year stability ($\pm 2 \times 10^{-7}$ /year optional) means the 3586A/B is tuned exactly where you want it. Or use the counter to measure a frequency precisely, then tune to it with one keystroke. This unique capability eliminates the need for "rocking" the tuning control to peak the signal.

North American (Bell) and CCITT Requirements

The 3586A & B Selective Level Meter and 3336 A & B Synthesizer/Level Generator are designed to meet most world-wide connector and impedance requirements for both carrier and voice channel measurements. Special or regional connectors can be provided by option or special request.

Input Configuration:

CCITT Requirements:

3586A SLM	75 Ω /10 k Ω Unbalanced 150 Ω , 600 Ω /10 k Ω Balanced
3336A Synthesizer	75 Ω Unbalanced 150 Ω , 600 Ω Balanced

North American (Bell) Requirements:

3586B SLM	75 Ω /10 k Ω Unbalanced 124 Ω , 135 Ω , 600 Ω /10 k Ω Balanced
3336B Synthesizer	75 Ω Unbalanced 124 Ω , 135 Ω , 600 Ω Balanced

The 3586A SLM uses an 800 or 1010 Hz nominal tone frequency reference for level measurements. A 1010 Hz notch for noise with tone and impulse noise and 1010 Hz for phase jitter measurements is used when the Transmission Impairments Option 003 is included. The 3586B SLM uses 1004 Hz for all tone and impairments measurements.

Wideband Power Measurement

RMS wideband power measurements from +20 to -45 dBm can be made from 20 kHz to 10 MHz with ± 1.0 dB accuracy and from 200 Hz to 32.5 MHz with ± 2.0 dB accuracy. Use this capability to make baseband power measurements.

Fully Programmable

HP-IB control is standard, allowing automatic operation to be controlled by a desktop calculator such as the HP Model 85A, 9825T, 9835A or 9845B, or by a main frame computer, such as the HP 1000. FDM tests such as surveillance can be made from a remote location to reduce maintenance costs and increase troubleshooting efficiency. See page 628 for information on 3046 A/B selective level measuring system.

Amplitude Offset

Make level measurements with respect to TLP or any offset level up to ± 199.99 dBm. Or make level measurements relative to a measured signal level, such as harmonics relative to a fundamental signal.

Frequency Tracking

The frequency of the 3336 A/B companion synthesizer will automatically be set to the frequency of the 3586A/B Selective Level Meter when in the tracking mode and with their HP-IB* inputs connected together. Make "loop-around" measurements on a telephone circuit or frequency response measurements on signal processing networks.

High Impedance Accessory Probes

Models 15580A, 15581B high-impedance probes are available for use with the 3586A/B for bridging measurements. See page 631 for probe specifications.

3336 A/B Synthesizer/Level Generator Description

The 3336 A/B Synthesizer/Level Generator is an excellent precision tracking signal source for the 3586A and B Selective Level Meter. When the Selective Level Meter and Synthesizer are in the tracking mode, the frequency of the synthesizer is automatically set to the frequency of the SLM. Frequency coverage is 10 Hz to 20.9 MHz, making the 3336 A and B useful for telephone circuit loop testing on most FDM systems, transfer function and distortion measurements in telecommunications manufacturing.

Frequency and Amplitude Precision

The 3336 A/B provides frequency resolution of one microhertz (.000001 Hz) up to 100 kHz and one millihertz (.001 Hz) to 20.9 MHz. Level accuracy is ± 0.15 dB at full output over the full frequency range with ± 0.12 dB optional. Harmonic levels are more than 60 dB down up to 1 MHz and more than 50 dB down up to 20.9 MHz, performance not previously available in a synthesizer.

FDM Testing

The flexible output section allows different connectors to be provided either by option or special request. Frequency entry is accomplished by keyboard or analog control for manual tuning or frequency stepping of any digit.

The Amplitude Blanking feature allows testing of operational FDM systems without disturbing adjacent channels while the frequency is changed. The output is blanked to less than -85 dBm until the next desired frequency is reached.

General Purpose Features

The 3336 A/B Synthesizer provides wide band sweep capability—sweep the full frequency range (or as little as two microhertz), log or linear, single or continuous. Single phase lock loop design means the sweep is phase continuous and you can modulate with AM to 50 kHz or PM to 5 kHz. Ten storage registers can be used to keep different test settings available for repetitive test. All necessary functions on the 3336 A/B can be remotely programmed by HP-IB control for automatic testing.

Designed-in Serviceability

The 3586 A/B Selective Level Meter and the 3336 A/B Synthesizer/Level Generator have been designed for reliable operation and excellent accessibility with many useful service features.

Abbreviated Specifications for 3586 A & B

(See Data Sheet or manual for complete specifications)



TELECOMMUNICATIONS TEST EQUIPMENT

Selective Level Meter / Synthesizer

Models 3586A/B and 3336A/B (Cont.)

Frequency

Signal Input	3586A	3586B
75 Ω Unbalanced	50 Hz to 32.5 MHz	
124 Ω Balanced		4 kHz to 10 MHz
135 Ω Balanced		4 kHz to 1 MHz
150 Ω Balanced	4 kHz to 1 MHz	
600 Ω Balanced	200 Hz to 100 kHz	

The 124 Ω , 135 Ω , 150 Ω and 600 Ω inputs are usable over wider frequency ranges, but are not specified in under and overrange operation.

Frequency resolution: 0.1 Hz.

Center frequency accuracy: $\pm 1 \times 10^{-5}$ /year, ($\pm 2 \times 10^{-7}$ /year with option 004).

Counter accuracy: ± 1.0 Hz in addition to center frequency accuracy for signals within the 60 dB bandwidth of the IF filter chosen or greater than -100 dBm (largest signal measured).

Frequency display: 9 digit LED.

Selectivity

3 dB Bandwidth, $\pm 10\%$:

3586 (CCITT)		3586B (N. American)	
Standard	Option 003	Standard	Option 003
20 Hz	20 Hz	20 Hz	20 Hz
400 Hz	400 Hz	400 Hz	400 Hz
1740 Hz	3100 Hz	2000 Hz	3100 Hz
—	Psophometric Noise Weighting	—	C-Message Noise Weighting

1. Psophometric Equivalent Noise Weighting Filter
2. C-Message Equivalent Noise Weighting Filter

Adjacent channel rejection: 75 dB minimum at ± 2850 Hz., 3100 Hz bw.

Passband flatness: $\pm .3$ dB.

Amplitude

Measurement range: +20 to -130 dBm.

Amplitude resolution: .01 dB.

Level accuracy: 10 dB autorange, low distortion mode, after calibration.

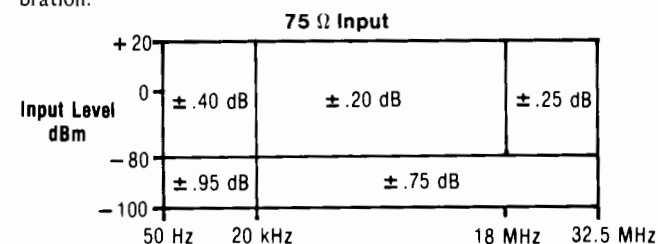

124 Ω Input (3586B): $\pm .35$ dB, 50 kHz to 5 MHz; $\pm .50$ dB, 10 kHz to 50 kHz, and 5 MHz to 10 MHz for +20 to -60 dBm.

135 Ω / 150 Ω input (3586A or B): $\pm .35$ dB 50 kHz to 1 MHz, $\pm .50$ dB 10 kHz to 50 kHz for +20 to -80 dBm.

600 Ω input (3586 A/B): $\pm .35$ dB 200 Hz to 108 kHz for +20 to -80 dBm.

Level accuracy: 100 dB range (after calibration): add correction to 10 dB autorange accuracy for dB below full scale. (Not required when in 10 dB autorange).

dB Below Full Scale	Accuracy Correction
0 to -20 dB	$\pm .25$ dB
-20 to -40 dB	$\pm .50$ dB
-40 to -80 dB	± 2.0 dB

Dynamic Range

Spurious responses:

Image rejection (100-132 MHz): -80 dBc.

IF rejection: 15625 Hz, -80 dBc; 50 MHz, -60 dBc.

Residual spurious signals: > 1600 Hz offset, -80 dBc; 300 Hz to 1600 Hz offset, -75 dBc.

Distortion:

Harmonic distortion: -70 dB below full scale (>4 kHz on 75 Ω and 600 Ω inputs), low distortion mode.

Intermodulation distortion: -70 dB below full scale, 200 Hz to 20 kHz offset; -75 dB below full scale, 20 kHz to 1 MHz offset.

Wideband power accuracy: after calibration, 100 dB range, averaging on, -45 to +20 dBm.

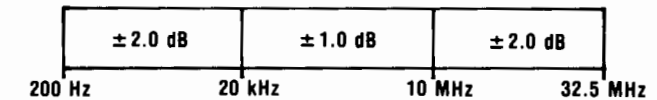

Noise Floor (Full Scale Setting -35 to -120 dBm):

Frequency	Bandwidth	Noise Level
100 kHz to 32.5 MHz	3100, 1740, 2000 Hz	-116 dBm
	20 Hz, 400 Hz	-120 dBm
10 kHz to 100 kHz	All	-105 dBm

The noise floor for full scale settings of -30 to +24 dBm will be 80 dB below full scale for > 100 kHz, or 60 dB below full scale for < 100 kHz.

Signal Inputs

Model	Impedance	Frequency	Mating Connector
3586A	75 ohms unbalanced	50 Hz to 32.5 MHz	BNC
	150 ohms balanced	10 kHz to 1 MHz	Siemens 3-prong
	600 ohms balanced	50 Hz to 108 kHz	9 Rei 6 AC
3586B	75 ohms unbalanced	50 Hz to 32.5 MHz	WECO 439/440A
	124 ohms balanced	10 kHz to 10 MHz	WECO 443A
	135 ohms balanced	10 kHz to 1 MHz	WECO 241A
	600 ohms balanced	50 Hz to 108 kHz	WECO 310

Connector options:

Opt 001 (3586A): 75 ohms mates with Siemens 1.6/5.6 mm coaxial.

Opt 001 (3586B): 75 ohms mates with WECO 358A. 124 ohms mates with WECO 372A.

(Contact local sales office for other special connectors.)

Return loss: -30 dB (600 ohms -25 dB).

Balance:

Input	Frequency	Balance
124 Ω	10 kHz to 10 MHz	-36 dB
135 Ω or 150 Ω	10 kHz to 1 MHz	-36 dB
600 Ω	50 Hz to 108 kHz	-40 dB

Demodulated Audio Output

Output Level: 0 dBm into a 600 Ω load, adjustable.

Output Connector: mates with WECO 347A.

Transmission Impairments Option 003

Adds transmission impairment measurement capability to standard instrument. Measures 2 band phase jitter, noise with tone, single level impulse noise and weighted noise at voice channel and carrier frequencies. Compatible with N. American (Bell) or CCITT standards.

Additional Options

3586A (CCITT)

Opt 001: 75 Ω input connector option. Siemens 1.6/5.6 mm coaxial connector replaces BNC.

Opt 004: High Stability Frequency reference 10 MHz oven stabilized reference oscillator improves frequency stability to $\pm 2 \times 10^{-7}$ /year.

3586B (N. American)

Opt 001: 75 Ω and 124 Ω input connector option. Changes 75 Ω input connector to mate with WECO 358A and 124 Ω input to mate with WECO 372A.

Opt 002: Psophometric equivalent noise filter option. Changes 2000 Hz filter (C-message equivalent) to 1740 Hz (Psophometric equivalent). Not available with opt 003.

Opt 004: High Stability Frequency reference. Same as Opt 004-3586A

Auxiliary Signal Inputs/Outputs

Tracking generator: 0 dBm rear panel tracking output.

External reference input: 1 MHz, 10 MHz or sub-harmonic input.

Reference output: 10 MHz, +8 dBm output.



Probe power: front panel DC output for HP active high impedance accessory probes.

HP-IB interface: rear panel interface meeting IEEE 488-1975 for remote operation. Used for tracking synthesizer interface.

Additional outputs: rear panel demodulated audio; phase jitter meter.

General

Operating Environment

Temperature: 0° to 55°C.
Relative humidity: 95%, 0° to 40°C.
Altitude: ≤15,000 ft; ≤4600 metres.

Storage Environment

Temperature: -40°C to 75°C.
Altitude: ≤50,000 ft; ≤15,240 metres.
Power: 100/120/220/240 V, +5%, -10% 48 to 66 Hz, 150 VA.
Weight: 23 kg (50 lbs) net; 30 kg (65 lbs) shipping.
Size: 177 mm H x 425.5 mm W x 466.7 mm D (7" x 16.75" x 18.38")

3336 A & B Abbreviated Specifications

(See Data Sheet or manual for complete specifications)

Frequency

Frequency range of signal outputs

Signal Output	3336A	3336B
75 Ω Unbalanced	10 Hz to 20.999 999 999 MHz	
135 Ω Balanced		10 kHz to 10.999 999 999 MHz
124 Ω Balanced		10 kHz to 2.099 999 999 MHz
150 Ω Balanced	10 kHz to 2.099 999 999 MHz	
600 Ω Balanced	200 Hz to 109.999 999 kHz	

All balanced outputs are usable over wider frequency ranges but are not specified in under and overrange operation.

Resolution: 1 μHz for frequencies < 100 kHz, 1 mHz for frequencies ≥ 100 kHz.

Accuracy (instruments without option 004): ± 5 x 10⁻⁶ of programmed frequency (20° to 30°C).

Aging rate: (instruments without option 004): ± 5 x 10⁻⁶/year (20° to 30°C).

Warm-up time: 30 minutes.

Amplitude

Range: 75 and 600 Ω outputs; -72.99 to +7.00 dBm.

124, 135 and 150 Ω outputs: -78.23 to +1.76 dBm.

Level accuracy, 20° to 30°C:

75 Ω output

dBm	± .15 dB		
+ 7.00	± .15 dB		
- 3.00	± .25 dB	± .30 dB	± .35 dB
- 13.00	± .30 dB	± .35 dB	± .40 dB
- 33.00	± .35 dB	± .40 dB	± .45 dB
- 72.99			
	10Hz	10MHz	10MHz 20.9MHz

75 Ω output with option 005*

dBm	Accuracy
+ 7.00	± .12 dB
- 3.00	± .16 dB
- 13.00	± .18 dB
- 33.00	± .22 dB
- 72.99	
	10 Hz
	20.9 MHz

*high accuracy attenuator

124 Ω output: 50 kHz to 10.9 MHz ± .15 dB -8.23 to 1.76 dBm, ± 0.3 dB - 18.23 to -8.24 dBm, ± 3.5 dB -38.23 to -18.24 dBm ± .4 dB -78.23 to -38.24 dBm.

135 Ω/150 Ω output: 10 kHz to 2.09 MHz, ± .17 dB -8.23 to +1.76 dBm, ± .32 dB - 18.23 to -8.24 dBm, ± .37 dB -38.23 to -18.24 dBm, ± .42 dB -78.23 to -38.24 dBm.

600 Ω output: 200 Hz to 109.9 kHz, ± .30 dB -3.00 to +7.00 dBm/ ± .40 dB -13.00 to 2.99 dBm, ± .45 dB -33.00 to -12.99 dBm ± .50 dB -72.99 to -32.99 dBm.

1. Add ±.03 dB for 0° to 55°C operation.

2. Warm-up time is 30 minutes.

Amplitude blanking: <-85 dBm output during blanking

Spectral Purity

Phase noise: <-72 dB, Models 3336A and 3336B, for a 3 kHz band, 2 kHz either side of a 20 MHz carrier.

Harmonic level: -35 dB, 10 Hz to 30 Hz; -50 dB, 30 Hz to 50 Hz; -60 dB, 50 Hz to 1 MHz; -55 dB, 1 MHz to 5 MHz; -50 dB, 5 MHz to 20 MHz.

Spurious: all non-harmonically related signals will be more than 70 dB below the fundamental or -100 dBm (-115 dBm with option 005 except 150 or 600 Ω), whichever is greater.

Phase Offset

Range: ±719.9° with respect to arbitrary starting phase or assigned zero phase.

Resolution: 0.1°.

Increment accuracy: ±0.2°

Ambient stability: ±1.0 degree of phase per degree C

Frequency Sweep

Sweep time: linear sweep, 0.01 s to 99.99 s, single log sweep, 2 s to 99.99 s, continuous log sweep, 0.1 s to 99.99 s

Maximum sweep width: specified frequency range of selected output

Minimum sweep width: log sweep, 1 decade; linear sweep, minimum sweepwidth (Hz) = 0.1 (Hz/s) x sweep time(s).

Phase Continuity: sweep is phase continuous over full frequency range.

Sweep flatness: ±0.15 dB, fast leveling, 10 kHz to 20 MHz, 0.03 s sweep time; ±0.15 dB, normal leveling, 50 Hz to 1 MHz, 0.5 s sweep time.

Amplitude modulation: modulation depth, 0 to 100%. Modulation frequency range, 50 Hz to 50 kHz.

Phase modulation: range, 0 to ±850°. Linearity, ±0.5% from best fit straight line. Modulation frequency range, dc to 5 kHz.

External leveling: input from an external voltage source to regulate the signal amplitude at a remote point.

Options

Option 001, 3336A/B Synthesizer/Level Generator:

1.6/5.6 mm 75 Ω input, (3336A). 75 Ω mates with WECO 358A, (3336B). 124 Ω connector mates with WECO 372A, (3336B).

Option 004, high stability frequency reference:

Accuracy: ± 5 x 10⁻⁸

Aging rate: ± 5 x 10⁻⁸/week after 72 hours continuous operation ± 1 x 10⁻⁷/month after 15 days continuous operation.

Ambient stability: ± 5 x 10⁻⁷ maximum, 0° to 55°C.

Option 005, high accuracy attenuator: Improves level accuracy and spurious level. See main specifications.

General

Operating Environment

Temperature: 0° to 55°C.

Relative humidity: ≤85%, 0° to 40°C.

Altitude: ≤15,000 ft., ≤4600 metres.

Storage Environment

Temperature: -50° to +65°C.

Altitude: ≤50,000 ft., ≤15,240 metres.

Power requirements: 100/120/220/240 V, +5%, -10%, 48 to 66 Hz, 60 VA, (100 VA with all options), 10 VA standby.

Size: 132.6 high x 425.5 wide x 425.5 deep; 5¼" x 16¾" x 16¾".

Weight: Net wt., 10 kg. (22 lbs). Shipping wt., 15.5 kg. (34 lbs).

Ordering Information

Price

3586A Selective Level Meter (CCITT)

\$9900

Opt 001: 1.6/5.6 mm 75 Ω Connector

add \$100

Opt 003: Transmission Impairments Option

add \$475

Opt 004: High Stability Frequency Reference

add \$625

3586B Selective Level Meter (N. American)

\$9900

Opt 001: 75 Ω Connector mates with WECO 358A

add \$100

and 124 Ω Connector mates with WECO 372A

N/C

Opt 002: 1740 Hz Equivalent Noise Bandwidth Filter

Replaces 2000 Hz. Not available with opt 003

Opt 003: Transmission Impairments Option

add \$475

Opt 004: Same as 3586A

add \$625

3336A Synthesizer/Level Generator (CCITT)

\$4400

Opt 001: 1.6/5.6 mm 75 Ω Connector

add \$100

Opt 004: High Stability Frequency Reference

add \$550

Opt 005: High Precision Attenuator

add \$550

3336B Synthesizer/Level Generator

(N. American)

\$4400

Opt 001: 75 Ω WECO 358A, 124 Ω WECO 372A

add \$100

Opt 004, 005: Same as 3336A

TELECOMMUNICATION TEST EQUIPMENT

Selective Level Measuring System

Model 3046A/B

- Low cost FDM surveillance
- Stored CCITT or Bell FDM plans
- Synthesizer frequency accuracy
- 0.2 dB amplitude accuracy
- Voice channel impairments
- Plotting and storage of data



Introduction

The 3046A/B systems are designed to automate measurements made on Frequency Division Multiplex (FDM) systems. These include tests such as pilot levels, carrier leaks and slot noise. The system, with all of its measurement power, requires no computer background to operate. Surveillance programs are configured simply by making choices from a series of measurement menus. The 3046A is designed for CCITT applications, while the 3046B meets North American (Bell) requirements.

This system is ideal for automating surveillance and routine maintenance on a local basis for small to medium capacity systems. Hewlett-Packard also provides automatic test equipment for large capacity FDM systems, using a distributed approach. See page 622 for a description of these automatic test systems. With a distributed system, remote selective level meters (SLMs) can be monitored from a central computer. With a local system such as the 3046A/B, each SLM and computer are independent, making installation and operation easier, and the system more mobile.

System Configuration

A standard 3046A/B system consists of the following:

- 3586A/B Selective Level Meter with Transmission Impairments
- HP 85F Personal Computer with 82903A Memory Module and Matrix ROM
- System Software (CCITT P/N 03046-90001; Bell 03046-90002)

The computer options listed are required for system operation. System software consists of FDM surveillance programs with stored CCITT (3046A) or Bell (3046B) plans, and system test software. The

system test software can be used to verify proper system operation and to help identify the faulty component in case of failure.

For applications requiring a precision signal source, a 3336A/B Synthesizer/Level Generator can be added to the system. A 0 dBm tracking source is standard with the 3586A/B.

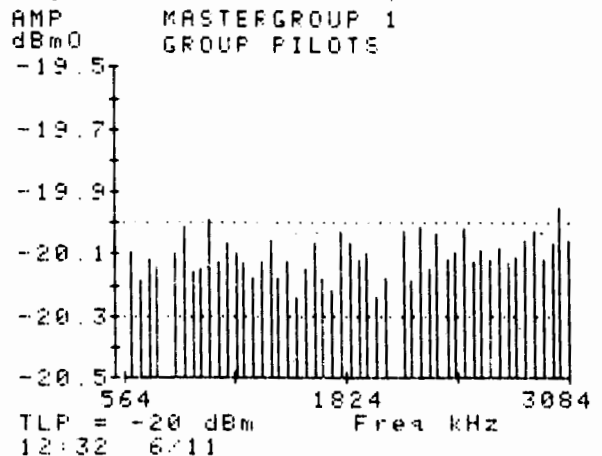

Tabular and Graphic Outputs

An automatic system will collect large amounts of data in a short time, making effective presentation of the results vital. In addition to a variety of tabular listing formats, the Selective Level

Measuring (SLM) System provides graphics—the ability to plot measured results. A plot of hundreds of data points can be analyzed in seconds, providing real insight into the condition of the system. With only a tabular listing, interpretation of hundreds of data points is difficult if not impossible. An active marker is provided to read the amplitude of any point on the graph to 0.01 dB resolution, and also list FDM number and frequency.

Storage of Tests and Data

Tests are performed with an automatic system in much the same way they are done manually. First, the measurement parameters (frequency, bandwidth, etc.) are set, and then the measurement is made. The SLM System provides for storage of test parameters on the computer's built-in tape. With this feature, often used test set-ups can simply be recalled from tape, rather than having to be re-entered each time the test is run. In addition, a program can be stored in a file that will load and run when power to the computer is cycled. In this way, a complicated series of tests can be run simply by turning the computer off and then on.

The system can also store measured data for future reference. Short term storage is automatic and has a capacity of 600 readings. This means that measured data can be retrieved any time after a test has been run. If an overnight test were run with only errors printed, this feature would allow printing or plotting of all the data in the morning.

Permanent storage on tape is also provided. This storage allows comparison of today's readings with those taken weeks or months earlier (limit is 600 readings). Data stored includes test limits, TLP, and the time of day and date when the measurement was made.

Timed Measurements

Every printout of test results includes time from turn on or time of day, and the date. The system also provides for delayed start of test and/or repetition of the test at timed intervals. This makes it easy to run a test at night or over a weekend, and to monitor system performance over time.

Provision for Custom Plans

An "array sweep" is available for testing of non-standard FDM plans. Each of four arrays has a capacity of 100 custom frequencies. Carrier tests can be performed at each test frequency, tested against limits and plotted or printed. Once an array of custom frequencies and the test at each is entered, it can be stored on tape for easy access.

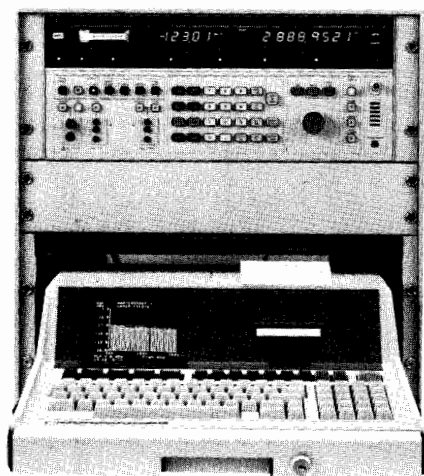

Option 400 Cabinet with Locking Drawer

Recommended Accessories

Disk Drive: A disk drive, such as an HP 82901M, provides much faster access to programs and data. This is highly recommended if the level of system interaction is expected to be high. A mass storage ROM (P/N 00085-15001) for the 85F is required for interfacing.

Access Switch: An access switch and switch controller can be added to the system with simple program modifications. The recommended controller is the HP 3755A, with several compatible switches available.

Printers and Plotters: For full size plots and printouts, an HP plotter, printer or printer/plotter can be added with a few simple program modifications. Suitable models include the 7225A Plotter and 7245B Plotter/Printer. A Plotter/Printer ROM (P/N 00085-15002) for the 85F is required for interfacing.

General

System Specifications

(System accuracy specifications are identical to those of the 3586A/B. Please refer to page 625.)

Measurement speed: 0.5 seconds/reading with no range change; 1.3 seconds/reading with range change; 3.3 seconds/reading with range change and Auto-cal.

System Tests

FDM Carrier Tests

Pilots:

3046A (CCITT): Group, Supergroup, Mastergroup, Super-mastergroup, and Hypergroup

3046B (North American): Group, Supergroup and Mastergroup pilots. Non-standard pilots can also be measured.

Carrier Leaks: Channel, Group and Supergroup.

Test Tones: 1010 Hz or 800 Hz (3046A) or 1004 Hz (3046B), and custom tones

Signalling Tones: 2600 Hz (3046B)

Channel Noise and Slot Noise:

3046A: Flat or Psophometric weighting

3046B: Flat or C-Message weighting

Other Tests

Transmission Impairments:

Phase Jitter

Weighted Noise with 3100 Hz channel filter

Noise with tone (notched noise)

Impulse noise can be measured and graphed over any period of time up to 90 minutes

Spot Frequency: In the spot frequency mode, the 3046 can measure and print the level at a single frequency. The point to be measured can be defined by frequency or FDM number. Wide band power can also be measured and printed out in this mode.

System Verification: The system verification program verifies operation of the 3586A/B and the 3336A/B, and can be used to locate the source of a hardware failure.

Physical Parameters

Temperature: 5 to 40°C

Relative Humidity: 95%, 0 to 40°C

Altitude: 4600 meters, 15,000 feet

Ordering Information

3046A/B Selective Level Measuring System \$15,300

3586A/B Options

001: Special Connector (3586A/B Option 001) \$100

004: High Stability Frequency Reference \$625

Synthesizer Options

100: 3336A/B Synthesizer/Level Generator \$4,500

101: Special Connector (3336A/B Option 001) \$100

104: High Stability Frequency Reference (3336A/B) \$550

105: High Accuracy Attenuator \$550

Cabinet Options

400: Locking Cabinet for Standard System \$1,600

450: Locking Cabinet for System with Synthesizer \$1,850

480: 220 V Operation N/C

Other Options

600: Delete 85F, Interface and ROMs -\$4,425

910: Extra Software and Documentation \$500



TELECOMMUNICATIONS TEST EQUIPMENT

Synthesizer/Level Generator 200 Hz to 80 MHz

Model 3335A

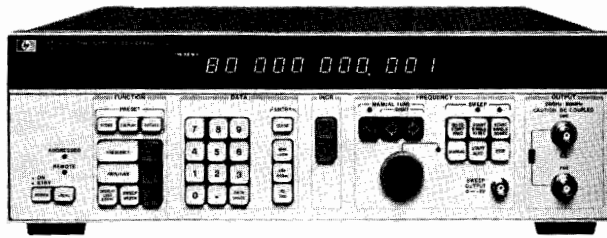

3335A



Description

The 3335A is a 200 Hz-80 MHz Synthesizer/Level Generator with performance characteristics that make it ideally suited for testing low-density carrier, radio baseband and high-density cable carrier systems as well as for R&D and production testing. It features precision level control, high frequency resolution (0.001 Hz from 200 Hz to 80 MHz), optional frequency stability of $\pm 5 \times 10^{-10}$ /day and high spectral purity. The 3335A is fully HP-IB programmable.

Precision Amplitude Control

High capacity FDM systems are placing more stringent requirements on testing transmission parameters. One such area where new standards of performance are required is amplitude control. The 3335A incorporates a state-of-the-art attenuator structure resulting in attenuator accuracies of up to ± 0.04 dB over the 80 MHz frequency range. A true rms leveling loop provides ± 0.15 dB flatness over the entire frequency range (± 0.10 dB from 1 kHz to 25 MHz) and 0.01 dB resolution over a 100 dB amplitude range. The 3335A can be externally leveled.

Digital Frequency Selection

Frequency is controlled via the front panel or by remote control with up to 0.001 Hz resolution. Frequency can also be changed by incrementing or decrementing the frequency by any arbitrary amount. FDM testing is simplified by stepping from channel to channel with a single keystroke.

Amplitude Blanking

The 3335A has switch selectable amplitude blanking to prevent disturbing a pilot tone when testing FDM systems. The output is blanked while the synthesizer tunes to the new frequency. This allows response testing of FDM systems while in service.

Internal Storage For Repetitive Testing

The 3335A's internal microprocessor-controlled memory can store any combination of parameters (frequency, level, etc.) of the instrument in 10 separate memory registers. The contents of these registers can then be recalled for fast and repeatable testing.

SLMS Tracking Generator

The 3335A operates as a tracking generator with the HP 3745A/B Selective Level Measuring Set (SLMS) and 3586A/B/C Selective Level Meter for automatic or semi-automatic testing of FDM systems. For closed-loop tracking, (3335A and 3745A/B in the same location), the frequency is controlled by the SLMS. The 3745A/B and 3335A can sweep through any selectable frequency spectrum or cycle through the channels of a multiplex system by calling up the FDM frequency plans stored in the SLMS memory. The 3335A and 3745A/B can also operate in an open loop tracking mode separated by the system under test or they can be interfaced via the HP Interface Bus (compatible with IEEE STD 488-1975) to a programmable calculator or computer for a completely automatic test system.

Options

Standard: Equipped with switch-selectable 50 Ω and 75 Ω outputs (BNC connectors).

001: High-stability frequency reference

002/004: Equipped with 75 Ω unbalanced and 124 Ω and 135 Ω balanced connectors per table.

Option	Fits WECO Type	Spacing	Accepts WECO Type
75 Ω 002 004	477B 560A	N/A	358A 439A/440A
124 Ω 002 004	477B 560A	16 mm (.625") 12.7 mm (0.5")	372A 443A
135 Ω 002/004	223A	16 mm (.625")	241A

003: 75 Ω unbalanced BNC output and 150 Ω balanced output using a pair of BNC connectors at 20 mm (0.80 in.) spacings.

Abbreviated Specifications

(For complete specifications, refer to page 386 and the 3335A data sheet.)

Frequency range:

Standard: 200 Hz-80 MHz;

Opt. 002/004: 75 Ω , 200 Hz-80 MHz; 124 Ω , 10 kHz-10 MHz; 135/150 Ω , 10 kHz - 2 MHz.

Opt. 003: 75 Ω , 200 Hz-80 MHz; 150 Ω , 10 kHz - 2 MHz

Frequency resolution:

.001 Hz.

Stability, long term:

$\pm 1 \times 10^{-8}$ /day; $\pm 1 \times 10^{-7}$ /month.

Opt. 001 (high stability frequency reference):

Aging rate: $\pm 5 \times 10^{-10}$ /day; $\pm 2 \times 10^{-8}$ /month; $\pm 1 \times 10^{-7}$ /year

Warmup: Within 5×10^{-9} of final value 20 minutes after turn-on at 25°C.

Spectral Purity

Harmonic distortion: 200 Hz-10 MHz: < -45 dB; 10 MHz-80 MHz: < -40 dB

Phase noise (30 kHz band, excluding ± 1 Hz, centered on the carrier): 9.9 MHz: < -63 dB; 20 MHz: < -70 dB; 40 MHz: < -64 dB; 80 MHz: < -58 dB

Spurious: Nonharmonically related signals 75 dB below the carrier or -110 dBm, whichever is greater

Amplitude range:

Standard: 50 Ω : +13.01 dBm to -86.98 dBm; 75 Ω : +11.25 dBm to -88.74 dBm.

Opt. 002/004: 75/124/135 Ω : +11.25 dBm to -88.74 dBm

Opt. 003: 75/150 Ω : +11.25 dBm to -88.74 dBm

Signal balance (124 Ω , 135 Ω , 150 Ω balanced outputs): > 40 dB

Resolution: 0.01 dB

Absolute level accuracy (max. output at 100 kHz, 20°C to 30°C): ± 0.05 dB

Flatness (relative to 100 kHz, full amplitude): 50/75 Ω : 1 kHz - 25 MHz: ± 0.07 dB; 200 Hz - 80 MHz: ± 0.15 dB. 124 Ω : 10 kHz - 10 MHz: ± 0.15 dB, 10 kHz - 10 MHz ± 0.4 dB; 135/150 Ω : 10 kHz - 2 MHz: ± 0.18 dB

Attenuator accuracy (relative to 100 kHz, full amplitude)

Impedance	Amplitude (dBm)	Frequency		
		200 Hz	25 MHz	80 MHz
50 Ω	+13.01 to -6.98	± 0.03 dB		
	-6.99 to -46.98	± 0.07 dB		
	-46.99 to 86.98	± 0.20 dB		

75 Ω	+11.25 to -8.74	± 0.04 dB	± 0.15 dB
	-8.75 to -48.74	± 0.09 dB	± 0.25 dB
	-48.75 to -88.74	± 0.20 dB	± 0.50 dB

NOTE: For 124 Ω , 135 Ω , and 150 Ω , refer to data sheet.

Options

- 001:** Hi-stability reference
- 002:** Connector option (75/124/135 Ω)
- 003:** Connector option (75/150 Ω)
- 004:** Connector option (75 Ω , miniature WECO on 124/135 Ω)

Price

- add \$580
- add \$350
- add \$200
- add \$350

3335A Synthesizer/Level Generator

\$8500

TELECOMMUNICATIONS TEST EQUIPMENT

SLMS Accessories

15575A-H, 15580A, 15581B, 15582A, 15584A, 15585A, 15589A



15580A



15581B

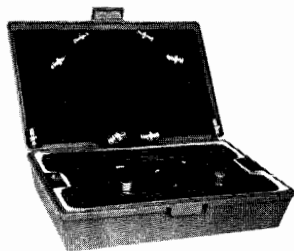

15582A



15575A-H

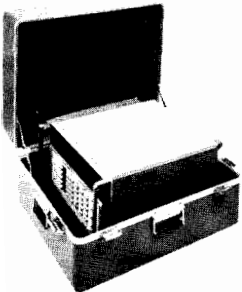

15584A

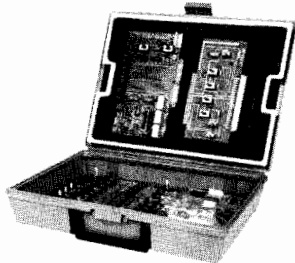

15585A

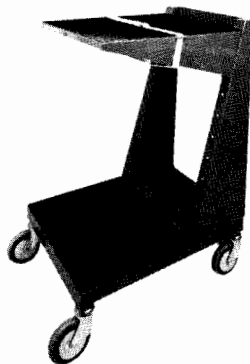

15589A

Active and Passive Probes

Models 15580A and 15581B High-Impedance Probes are used with the SLMS for bridging measurements. The 15580A is an "active" device having an insertion loss of 0 dB. Model 15581B is a passive probe having an insertion loss of 20 dB. The 15581B can also inject signals from a Level Generator at points where a high impedance source is required. See Data Sheet (5952-3218) for options.

Specifications

Parameter	15580A	15581B
Frequency Range	20 kHz to 25 MHz	10 kHz to 25 MHz
Insertion Loss	0 dB \pm 0.2 dB (50 kHz to 20 MHz)	20 dB \pm 0.2 dB (50 kHz to 20 MHz)
Tapping Loss (in 75 Ω system)	<0.15 dB (50 kHz to 20 MHz)	<0.25 dB (50 kHz to 20 MHz)
Max Input Power	+10 dBm	+25 dBm
Power Supply	+15 V (25 mA)	—
Price	\$485	\$395

Return Loss Kit

\$700

Model 15582A Return Loss Kit, with a suitable Level Generator, allows the SLMS to make return loss measurements from 10 kHz to 25 MHz. Extended coverage from 100 kHz to 90 MHz is possible with Model 8721A Opt 008 Directional Bridge.

Cable Equalizers

\$280

Models 15575A-H constitute a range of eight Cable Equalizers, designed to equalize the Loss/Frequency characteristics of different lengths of 75 Ohm coaxial cable.

Transit Case

\$550

Model 15584A is a fibre-glass transit case with custom-moulded foam inserts to suit the 3745A/B or 3747A/B SLMS.

Diagnostic Kit

\$1465

Model 15585A consists of several troubleshooting aids which assist in servicing the SLMS.

Instrument Cart

\$810

Model 15589A is suitable for transporting the SLMS and its auxiliary equipment.

In many countries the main communication system consists of a network of FM microwave radio links. Typically, these links can carry up to 1800 FDM telephone channels, using a 70 MHz IF carrier and an RF band in the range 600 MHz to 18 GHz. However, some countries are now installing 140 MHz IF microwave links which can carry up to 2700 FDM telephony channels.

All information signals (speech, television, or data) carried by these links have a common objective—to convey the information with maximum fidelity. Failure to keep distortion in a link within specified limits results in an unacceptably high level of intermodulation noise. This prevents the link from carrying the designated channel capacity and the link operator incurs a severe financial penalty due to loss of revenue-earning channels.

Measurements required on a microwave link are of two distinct types – qualitative and diagnostic. Qualitative measurements, often made using test signals which simulate normal traffic, are intended to assure the operator that the microwave link is performing correctly. Such measurements are normally made from baseband to baseband and

show the overall system performance without giving much diagnostic information if discrepancies are found. Table 1 shows a list of qualitative measurements for both video and FDM traffic together with the capabilities of the 3724A/25A/26A Baseband Analyzer. This instrument provides, in addition to White Noise tests, all the baseband measurements normally required in the design, production, installation, and maintenance of FDM radio systems.

It is often desirable to make qualitative measurements hop-by-hop along a microwave link to ensure that each individual section is set up correctly. In many cases this requires the use of a 70 MHz modem since baseband signals are not available in non-demodulating repeaters. The 3717A 70 MHz Modulator/Demodulator provides this capability and, with its comprehensive range of pre- and de-emphasis options, is a useful companion instrument to the Baseband Analyzer. In addition, since it is fully specified, it may be used as a standby for the link's own modem. If the qualitative tests show that the distortion in a microwave link is too high, then diagnostic measurements are required to discover the source of the problem.

The main contributors to distortion in FM microwave radio links are the modulators, demodulators and carrier circuits at IF such as amplifiers, and carrier circuits at RF such as non-linear amplifiers. The distortion parameters of these circuits can be measured in terms of nonlinearity, amplitude variations and group delay variations. To do this, test equipment must interface with the links at BB, IF and RF. Commissioning microwave link equipment involves minimizing these circuit distortion parameters by adjustment or equalization.

On lower capacity systems, these adjustments are normally enough to reduce intermodulation distortion to an acceptable level. With increased traffic capacity, the tolerances imposed on the circuit parameters become more and more strict and normal commissioning methods often do not produce satisfactory results. Consequently, relating the circuit parameters to the intermodulation noise (measured by a noise-loading test set) becomes increasingly more difficult.

The main source of discrepancy is the result of amplitude modulation to phase modulation (AM/PM) conversion in the transmission carrier path. This AM/PM conversion occurring in non-linear networks introduces additional intermodulation from the signal deviations arising in preceding networks. These 'coupled' responses can be assessed only by differential gain/differential phase (DG/DP) measurements with high-frequency test tones. HP Application Note AN 175-1 'Differential Phase and Gain at Work' covers this subject in considerable detail.

HP microwave link analyzers (MLA's), at 70 MHz IF or dual 70/140 MHz IF, were developed specifically for the purpose of measuring various forms of distortion on terrestrial and satellite microwave radio links. The measurement capabilities of HP link analyzers, as shown in Table 2, were established in close cooperation with the telecommunications industry.

A valuable extension of the MLA measurement capability can be obtained using RF up and down converters. The circuit distortions at RF have identical effects to the IF circuit distortions when the carrier signal is eventually demodulated. Hence, the RF distortions can be analyzed using an MLA, provided a transparent RF-to-IF interface is available. A down converter provides such an interface and allows independent measurements on microwave transmitters. A so-called 'up-converter' in fact provides a transparent BB-to-RF interface, allowing independent measurements on microwave receivers. Both converters used with an MLA provide an RF-to-RF measurement capability.

Table 1. Qualitative tests to verify radio system performance

Test	FDM	Video	3724A/25A/26A
1. Insertion Gain	•	•	•
2. Frequency Response	•	•	•
3. Envelope Delay Distortion		•	
4. Spurious Interference Tones	•	•	•
5. Thermal Noise	•	•	•
6. White Noise Loading	•		•
7. Video Waveform Tests		•	
8. Video System Program Channel (Subcarrier) Tests		•	

Table 2. Diagnostic tests to maintain radio system performance

Measurement	BB	IF	RF
1. Module Power Levels, Gains and Losses	•	•	•
2. Modem Centre Frequencies		•	•
3. TX and RX Local Oscillator Frequencies			•
4. Transmitter RF Output Frequency			•
5. Spurious Tones	•	•	•
6. FM Mod + Demod Deviation Sensitivity	•	•	•
7. FM Mod + Demod Linearity	•	•	•
8. Return Loss	•	•	•
9. Amplitude Flatness	•	•	•
10. Group Delay		•	•
11. Differential Gain and Phase		•	•

TELECOMMUNICATIONS TEST EQUIPMENT

RF-IF Microwave Link Analyzer

Model 3707A



- For testing direct modulation digital radio systems
- RF-IF and RF-RF measurements
- Low cost

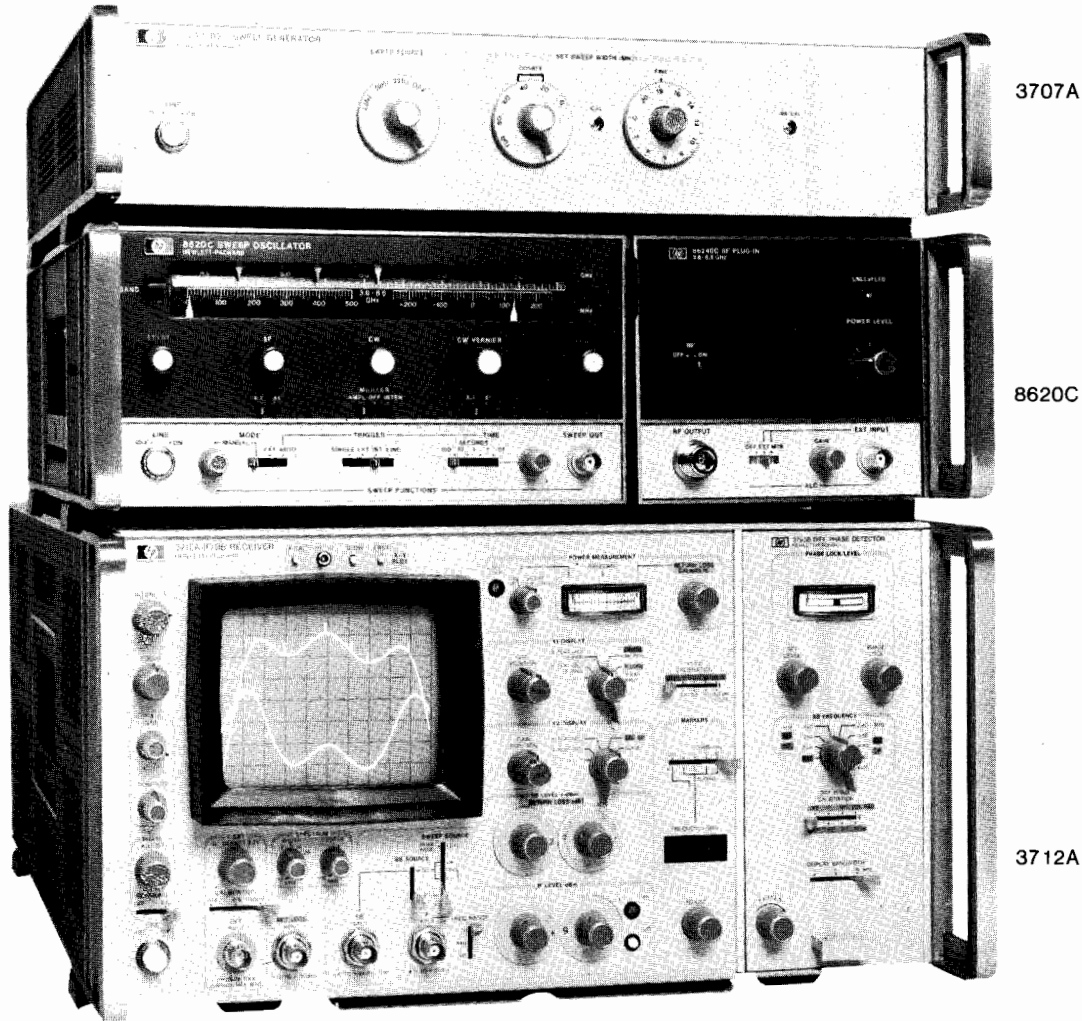

Increasingly popular direct RF modulation systems do not always require the IF transmitter sections of conventional microwave link analyzers. Hence, the 3707A BB + Sweep Generator has been designed to drive an 8620C Sweep Oscillator, giving a swept, frequency-modulated source in the range 0.5 to 18 GHz. This source, in conjunction with a standard 3702B or 3712A IF/BB Receiver, allows measurement of transmission distortions in the radio link.

Although the principal area of application is in digital-radio testing, the instruments are equally useful on analog radios which use direct modulation. A single low-frequency test tone of 250 or 500 kHz (internally selectable) is provided which allows the measurement of linearity or group delay. The 3702B IF/BB Receiver is suitable for use on systems with a 70 MHz receive IF, while the 3712A provides, in addition to 70 MHz, a capability at 140 MHz. A 3730B Down Converter, with appropriate RF plug-in, may be used to help isolate distortions in the RF parts of the link.

The complete system has been designed with low cost and ease of use as primary considerations and so is ideal for routine maintenance as well as installation and production applications.

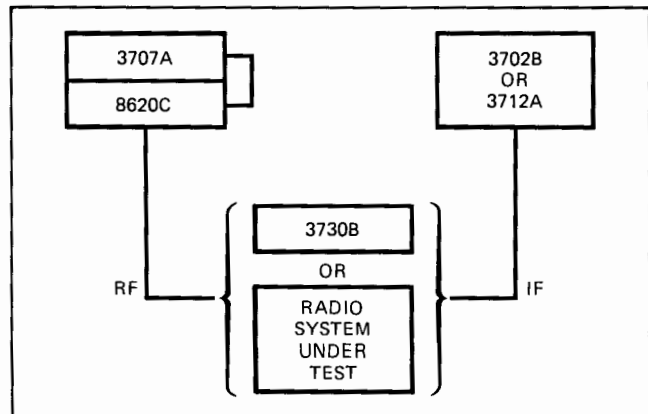

3707A BB + Sweep Generator

\$2115

TELECOMMUNICATIONS TEST EQUIPMENT

Microwave Link Analyzers and Accessories

Models 3711A/3712A, 3710A/3702B, 3743A, 3750A

- Test analog and digital radios
- Isolate and characterize causes of intermodulation distortion in wideband FM microwave radios

- Baseband and IF interfaces
- 70/140 MHz or 70 MHz only IF capability
- Selectable combinations of BB test tones

70/140 MHz IF MLA System

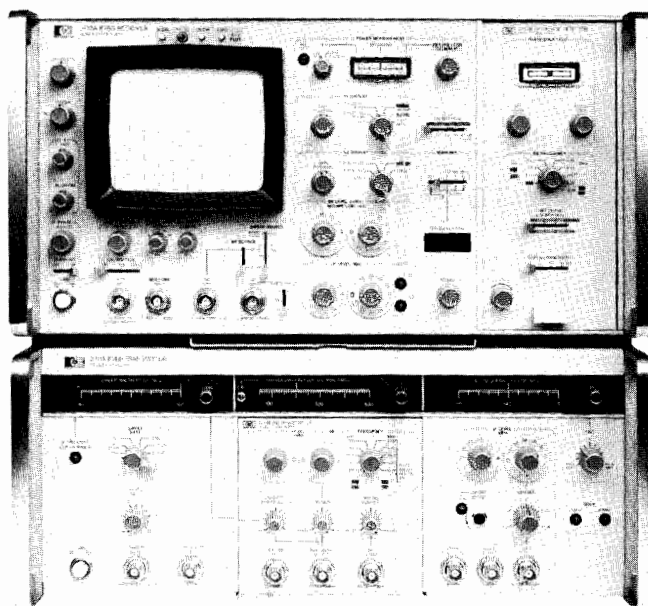

3711A IF/BB Transmitter
3791B BB Transmitter (Plug-in)
3712A IF/BB Receiver
3793B Diff. Phase Detector (Plug-in)

70 MHz IF MLA System

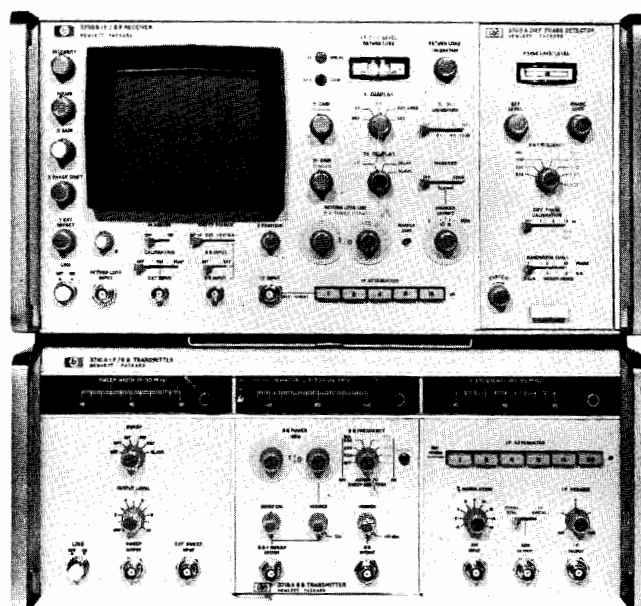

3710A IF/BB Transmitter
3715A or 3716A BB Transmitter (Plug-in)
3702B IF/BB Receiver
3703B or 3705A Group Delay Detector (Plug-in)

Two versions of the Microwave Link Analyzer (MLA) are available: the 70 MHz IF 3710A/3702B System, and the dual 70/140 MHz IF 3711A/3712A System. For microwave radio stations employing both 70 and 140 MHz intermediate frequencies, the dual IF MLA is an economical way of providing a complete range of dedicated measurements at both IF's.

The 3710A/3702B and 3711A/3712A MLA's isolate and characterize causes of intermodulation distortion in wideband microwave radios. They have applications in both analog and digital radio systems. Measurements performed by the MLA's include:

- BB power, gain, and loss
- IF power, gain, and loss
- modulator/demodulator deviation sensitivity
- modulator/demodulator linearity
- modulator/demodulator group delay
- swept IF amplitude response
- swept IF group delay
- swept IF return loss
- BB and IF differential gain (HF linearity)
- BB and IF differential phase (HF group delay)
- BB return loss

When used with the 8620C/86200 Series RF Sweeper system (equipped with the MLA interface option) and the 3730B RF Down Converter, the swept measurements of the basic MLA's can be extended to RF. Pages 636 and 637 give further details about this RF instrumentation (3730B and 8620C).

Apart from the dual 70/140 MHz IF capability, with the full range of measurements available at both frequencies, the 3711A/3712A MLA has many other refinements over earlier systems. These include an improved marker system, an IF input frequency counter, improved input sensitivity at -19 dBm, a slope control, a 16 dB dynamic display range, and X-Y Recorder facilities.

Another major contribution is the provision of an interface for the 8501A Storage-Normalizer. Use of this instrument with the 3711A/3712A MLA provides digital averaging and normalizing facilities. Further, measurement limit masks and adjustment instructions can be displayed on the MLA screen when a desk-top computing controller is used with the Storage-Normalizer.

A series of options are available with the MLA's, including:

- test-tone frequencies
- connectors
- balanced 124 Ω baseband impedance
- sweep frequencies
- variable phase output of sweep signal

Options (3711A/3712A and 3710A/3702B MLA's)

To compile a suitable MLA System for your application, select *one* of the following combinations:

70/140 MHz IF— 3711A/3791B/3712A/3793B.

70 MHz IF with low- and high-frequency test-tones— 3710A/3716A/3702B/3705A.

70 MHz IF with low-frequency test-tones only— 3710A/3715A/3702B/3703B.

Connector Options

(3711A/3791B/3712A/3710A/3716A/3715A/3702B only)

Option	BNC	Siemens Large	Siemens Small	WECO 477B	WECO 560A
Std	•				
002		•			
003			•		
004				•	
005*					•

* Available with 3711A/3791B/3712A only.

Test-tone (BB) Options

(3791B/3793B/3716A/3715A/3705A/3703B only)

3791B/ 3793B/ 3716A/ 3705A Options	Test-tone Frequencies (MHz except where indicated)											
	83.333 kHz 250 kHz & 500 kHz	92.593 kHz 277.778 kHz & 555.556 kHz	2.4	3.50	3.58	4.43	4.50	5.60	8.20	12.39		
Std	•		•								•	•
010		•	•								•	•
011		•	•								•	•
012		•	•								•	•
013	•		•			•					•	•
014	•		•	•							•	•
016	•		•								•	•
018	•		•								•	•
019	•		•								•	•
021*		•	•								•	•
022	•		•								•	•
3715A/ 3703B Options												
Std	•											
009		•										

* Available with 3791B/3793B only.

Sweep Frequency Options (3711A/3710A only)

Option	70 Hz	LINE	Opt			
			70 Hz	50 Hz	100 Hz	18 Hz
Std	•	•	•			
006	•	•		•		
007	•	•			•	
015	•	•				•

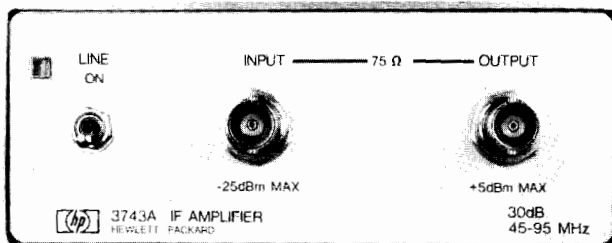

3743A IF Amplifier

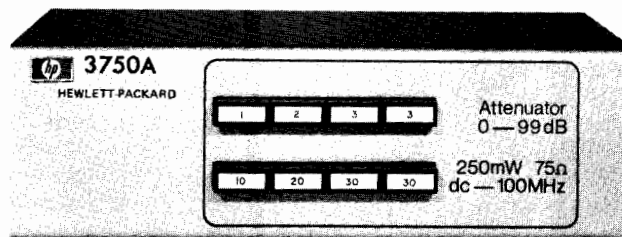

3750A Attenuator

Miscellaneous Options

008 (3711A/3710A only) Variable phase sweep output.

015 (3793B/3705A only) Additional phase detector bandwidths of 90 and 180 Hz—must be used with 18 Hz sweep rate on 3711A or 3710A IF/BB Transmitter.

020 (3712A only) CRT graticule illumination.

908 (3711A/3712A/3710A/3702B only) Rack mounting kit.

910 Extra manuals.

3743A IF Amplifier

- Improve MLA IF input sensitivity to -40 dBm.
- Frequency range 45 to 95 MHz.
- Group delay <0.3 ns.
- Amplitude flatness <0.2 dB.
- Return loss >26 dB (75 Ohm).
- Noise figure ≤8 dB.

3750A Attenuator

- Impedance 75 Ohm.
- Attenuation range 0 to 99 dB, in 1 dB steps.
- Frequency range dc to 100 MHz.

Ordering Information

70/140 MHz system (3711A/3791B/3712A/3793B) \$33,755

70 MHz system with low- and high-frequency test-tones (3710A/3716A/3702B/3705A) \$24,885

70 MHz system with low-frequency test-tones only (3710A/3715A/3702B/3703B) \$23,045

3743A IF Amplifier \$1,450

3750A Attenuator \$620

TELECOMMUNICATIONS TEST EQUIPMENT

RF Down Converter

Model 3730B

- RF to IF frequency conversion
- 1.7 to 14.5 GHz frequency range
- Extends test capability of MLA's to RF
- 70 or 140 MHz IF output

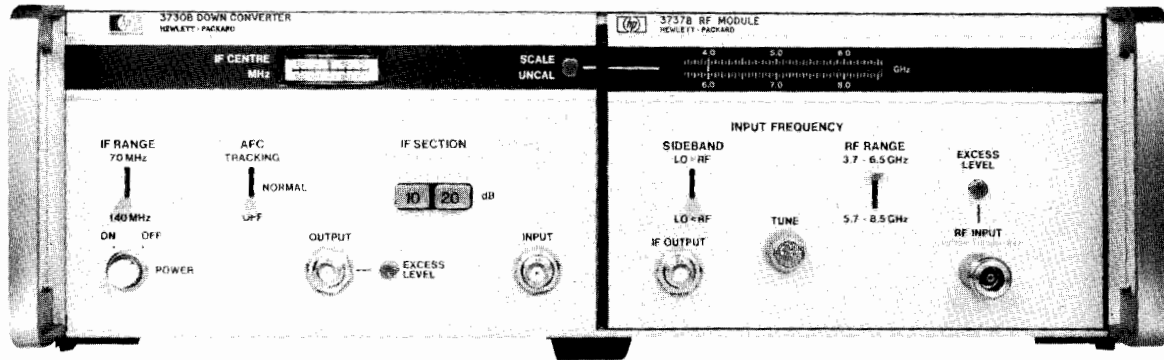

3730B Option 010 Down Converter mainframe with 3737B RF Module plug-in

The 3730B Down Converter and plug-ins provide RF to IF conversion and RF test capabilities for Microwave Link Analyzers (MLA's). The 1.7 to 14.5 GHz RF range is accommodated by a series of local oscillator plug-ins, allowing easy tuning to the desired operating frequency.

The 3730B has dual IF capability which allows the Down Converter to interface with single 70 MHz IF (eg the 3710A/3702B) or dual 70/140 MHz IF (eg the 3711A/3712A) MLA's, or with wide-band demodulators (eg the 3717A) when white noise loading.

A tracking AFC and recovered sweep facility causes the local oscillator in the 3730B to track the incoming swept RF signal, thus almost eliminating the swept component of the IF signal. Note that because of the effective sweep compression of the IF signal, the residual distortions of both the Down Converter and Microwave Link Analyzer receiver are reduced considerably.

On a microwave radio route containing a number of repeater stations, the local oscillator can be positioned above or below the carrier frequency and this can vary from repeater station to repeater station. This can cause difficulties when comparing MLA responses between stations due to frequency axis inversion of the swept response. Selecting upper or lower sideband operation on the 3730B overcomes this problem.

Lengthy runs of RF cable between the Down Converter and the RF test point can generate ripple responses which can mask the true measurement response. To avoid this problem, it is possible to remove the Down Converter plug-in and mount this directly onto a waveguide test point. The plug-in is then connected to the 3730B mainframe by an umbilical cable. Only IF signals which are less susceptible than RF signals to lengthy runs of interface cable are transmitted along the umbilical cable.

Option 010 of the 3730B incorporates an additional IF section, comprising a 25 dB fixed gain amplifier and a 30 dB stepped attenuator, to ensure that the IF signal level is sufficient to drive most MLA's when operating at RF input levels below -12 dBm. Note that no degradation of the residual performance specifications occurs when this option is fitted.

Various connector types can be fitted on a special basis. Only BNC connectors are offered on the standard product; to interface with equipment fitted with other types of connector, the following adapter cables are recommended:

15525A Opt 008: BNC to large Siemens cable.	\$72
15525A Opt 009: BNC to small Siemens cable.	\$72
15525A Opt 006: BNC to WECO 477B cable.	\$84
15525A Opt 007: BNC to WECO 560A cable.	\$77

Specifications

3730B + 3736B/7B/8B/9B

Residual performance:

	50 MHz Sweep Width at 70 MHz centre frequency	100 MHz Sweep Width at 140 MHz centre frequency
Amplitude Response	0.2 dB	0.3 dB
Group Delay	0.2 ns	0.3 ns
Diff Gain (5.6 MHz test tone)	0.3%	0.5%
Diff Phase (5.6 MHz test tone)	0.3°	0.5°

The residual specifications quoted are measured using the FM Sweep Input to reduce the residual contributions of the RF test source, and using storage normalizer techniques to remove MLA receiver contributions.

Min RF input level: -15 dBm, typically (-40 dBm when Opt 010 is fitted), for correct operation of MLA; however, min input level dependent on input sensitivity of MLA and RF-IF gain conversion of Down Converter (3710A/3702B MLA—min input sensitivity -10 dBm; 3711A/3712A MLA—min input sensitivity -19 dBm).

Size: 141 mm H x 425 mm W x 467 mm D (5.5 x 16.75 x 18.38 in.)

Power supply: 100, 120, 220, or 240V ac, +5 -10%; 48 to 66 Hz; consumption 100 VA max, including plug-in.

Weight: 11.9 kg (26 lb) net, including plug-in.

Temperature range: 0 to 55°C, operating.

Options

010: 25 dB fixed gain amplifier, with 30 dB (10 dB step) attenuator.

Price

add \$1195

Accessories

15600A Isolator: 3.7 to 4.2 GHz.	\$660
15601A Isolator: 5.9 to 6.5 GHz.	\$630
15602A Isolator: 7.1 to 8.5 GHz.	\$560
15603A Isolator: 10.7 to 11.7 GHz.	\$760
15609A Remote Extender Cable: 3 metre umbilical cable.	\$420

Ordering Information

3730B Down Converter	\$4,060
3736B 1.7 to 4.2 GHz	\$5,005
3737B 3.7 to 8.5 GHz	\$6,675
3738B 5.9 to 11.7 GHz	\$7,230
3739B 10.7 to 14.5 GHz	\$10,565

TELECOMMUNICATIONS TEST EQUIPMENT

637

RF Sweeper MLA Upconverter Simulation

Models 8350A, 8620C, 86200 Series RF Plug-ins



- MLA Upconverter Simulator Options 0.5 to 18.0 GHz
- Use with MLA or as a general purpose sweeper
- Swept and CW RF Source
- Test Digital & Analog Microwave Radio Systems & Components

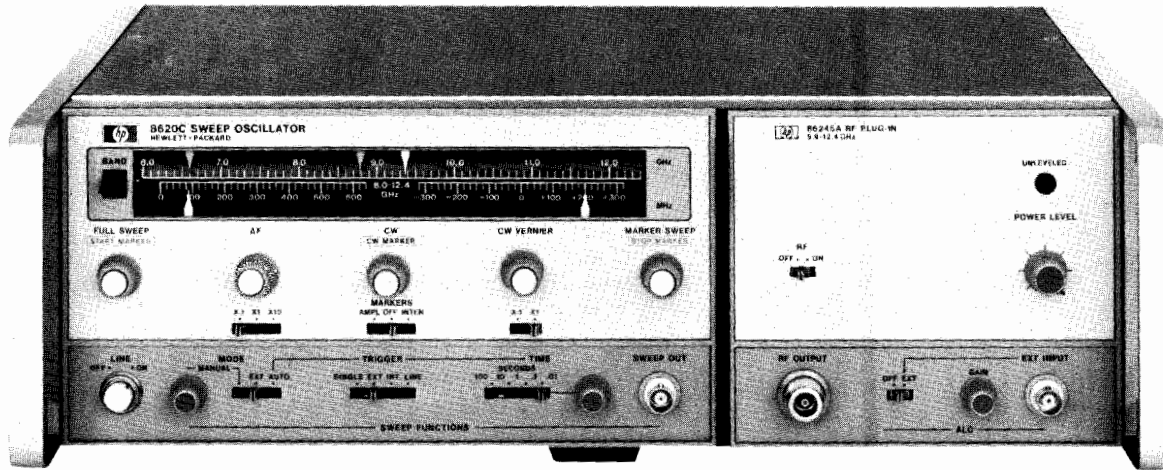

8620C / 86245A

Description

The 8620C Sweep Oscillator and 86200 Series of RF plug-ins provide a high performance, solid state source for Microwave Radio System tests via MLA Upconverter Simulation Options. These permit accurate RF-to-BB, RF-to-IF and RF-to-RF distortion measurements to be made with the 3700 Series MLA Systems. The plug-ins can also be used as standard sweeper plug-ins, with the only basic difference being modified FM circuitry. The RF-to-RF measurements must be made in conjunction with the 3730B RF Down Converter. This allows group delay, linearity, differential gain and phase measurements to be made on RF devices and components within the Microwave Radio System. The 8350A Sweep Oscillator Mainframe is also compatible with the 86200 series MLA option plug-ins through the use of the 11869A Adapter (see page 434).

Specifications

The 8620C/86200 Series MLA Upconverter Simulation Plug-ins are optimized for group delay, linearity, and differential gain and

phase over the specified frequency range. All plug-ins can be used with MLA sweep widths of 100 MHz or less. The following specifications supplement the standard 8620C system specifications (covered on pages 435-441).

Complementary Equipment

Equipment	Price
8350A Sweeper Mainframe	\$4250
11869A Adapter	\$200
8620C Sweeper Mainframe (required)	\$2850
To properly interface the 8620C/86200 Series plug-in to the item under test, the following are recommended for optimal performance:	
784C Directional Detector (1.7 - 12.4 GHz)	\$1350
Flatness over any 30 MHz: $< \pm 0.1$ dB	
Equivalent source match: typically ≤ 1.5	
11675B Leveling Cable Assembly (1.7 - 12.4 GHz)	\$450
Group delay: ≤ 0.25 ns p-p (with 1.25 SWR at each end)	

MLA Upconverter Simulation Plug-in Specifications (25°C)

Model Number	MLA Option Number	MLA Freq. Range (GHz)	Group Delay (ns) p-p	Linearity (%)	Diff. Gain (%)	Diff. Phase (°)	FM Sens. (MHz/V)	Price W/MLA Option
			@277.7 kHz		@5.6 MHz ¹			
Across Any 30 MHz BW								
86222A/B	H80	0.5-2.4	<3	<2.5	<2.5	<3	N/S	\$5670/6650
86235A	008	1.7-4.3	<2	<2.0	<2.0	<2	+20	\$4250
86240C	—	3.6-8.6	<1	<0.5	<0.5	<1	+20	\$5450
86242D	008	5.9-9.0	<1	<0.5	<0.5	<1	+20	\$4000
86245A	008	5.9-12.4	<1	<0.5	<0.5	<1	+20	\$6600
86250D	008	8.0-12.4	<1	<0.5	<0.5	<1	+20	\$4100
86260A	H82	12.0-18.0	<3	<2.5	<2.5	<3	N/S	\$5350

¹Except 86222A/B & 86260A which are tested @ 2.4 MHz.

For applications requiring better distortion specifications, HP also offers plug-in systems which include a leveling cable and directional coupler. These systems are available in the following bands: 1.7-2.4 GHz, 3.6-4.3 GHz, 5.8-6.5 GHz, 7.0-8.6 GHz, 10.7-11.7 GHz, and 12.2-12.7 GHz. The system specifications are as follows:
Group delay @ 500 kHz: < 0.5 ns p-p

Linearity @ 500 kHz: $< 0.25\%$

Flatness: $< \pm 0.1$ dB

For more information consult your local HP Field Engineer.

The options shown after each plug-in provide the special MLA interface capability. Refer to pages 435 to 441 for details on other RF Sweeper plug-in specifications and options.

TELECOMMUNICATIONS TEST EQUIPMENT

70 MHz Modulator/Demodulator

Model 3717A

- Up to 5 pre-/de-emphasis networks
- Video and telephony inputs and outputs
- Service channel provided
- Built-in 15 dB open-ended attenuator
- Optional HP-IB control
- Optional balanced BB input and output

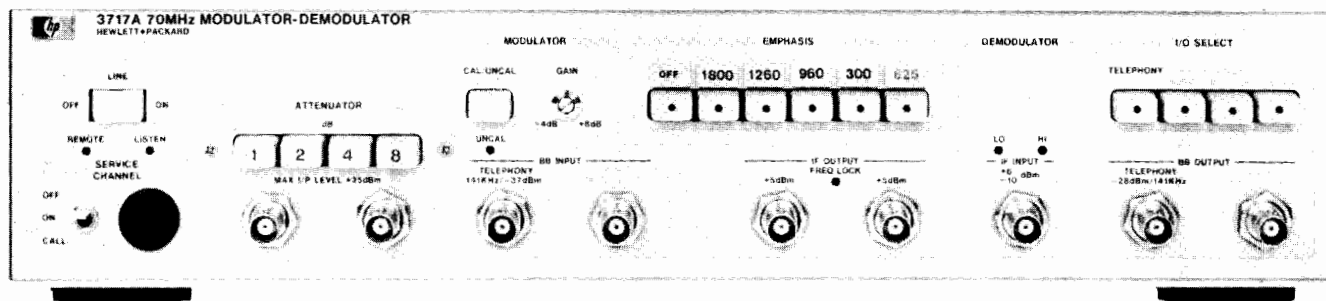

The 3717A 70 MHz Modulator/Demodulator can be used in microwave radio link systems to enable BB qualitative measurements to be made at non-demodulating repeater stations.

Standard measurement practice for the alignment and maintenance of microwave radio links involves two specific categories of tests, i.e. swept response measurements and BB qualitative measurements. Normal practice is to align a microwave radio initially by using swept response techniques such as those provided by an MLA. After these measurements have been completed successfully, qualitative measurements such as white noise loading, TV waveform testing, and BB frequency response are performed at the BB terminals of the microwave radio to verify operational performance.

However, the optimum swept response does not always produce the best possible qualitative figure. When this happens it may be necessary to isolate the faulty section by performing qualitative measurements from BB terminal stations to IF repeater stations, or vice versa. To do this, a high quality wideband test modulator or demodulator is required. The 3717A provides this capability.

Specifications Summary

Back-to-Back Performance (Telephony)

BB Frequency Response (with or without Emphasis)

50 Hz to 10 MHz: ± 0.2 dB.

50 Hz to 20 MHz: ± 3 dB.

Noise Loading Performance

At manual loading for all slots, 70 to 7600 kHz (1800 channels with emphasis): ≤ 25 pWOp (57 dB NPR).

Thermal: mod/demod is thermally dominated and will typically tolerate a 6 dB overload with no degradation.

Spurious Response

300 kHz to 10 MHz: ≤ -72 dBm0.

Back-to-Back Performance (Video)

BB Frequency Response

5 Hz to 10 MHz: ± 0.2 dB.

Square wave tilt (50 Hz): $< 1.0\%$.

Diff. Gain (4.43 MHz): $\leq 0.7\%$.

Diff. Phase (4.43 MHz): $\leq 0.7^\circ$.

*Measured on an HP Microwave Link Analyzer with a test tone of 4.43 MHz.

Options

Connector options—select any one.

Std: BNC

003: Siemens small.

004: commercial equivalent of WECO 477B balanced input.

Emphasis networks—up to five may be installed and should be specified with every order.

CCIR

011: 24 channel emphasis.

012: 60 channel emphasis.

013: 120 channel emphasis.

014: 300 channel emphasis.

015: 600 channel emphasis.

016: 960 channel emphasis.

017: 1260 channel emphasis.

018: 1800 channel emphasis.

021: 525 line emphasis.

022: 625 line emphasis.

023: 819 line emphasis.

Bell

031: Bell 600 channel emphasis.

032: Bell 900 channel emphasis.

033: Bell 1200 channel emphasis.

034: Bell 1500 channel emphasis.

035: Bell 1800 channel emphasis.

036: Bell 2100 channel emphasis.

037: Bell 2400 channel emphasis.

Miscellaneous

006: deletes Modulator section.

007: deletes Demodulator section.

100: HP-IB.

136: Combination of options 003 and 006.

137: Combination of options 003 and 007.

146: Combination of options 004 and 006.

147: Combination of options 004 and 007.

3717A 70 MHz Modulator/Demodulator

Price

NC

NC

+\$885

+\$195

+\$195

+\$195

+\$195

+\$195

+\$195

+\$195

+\$195

+\$195

+\$195

+\$195

+\$195

+\$195

+\$195

+\$195

+\$195

+\$195

+\$195

-\$2115

-\$2335

+\$285

-\$2115

-\$2335

-\$1230

-\$1450

\$9455

- Automatic noise power ratio scan of up to four slot frequencies
- SLMS scan routines with variable violation limits
- Spectrum analysis for spurious signal identification
- BB frequency response—locally or end to end with storage and normalisation
- Broadband power down to -70 dBm
- Easy conversion between level measurement units

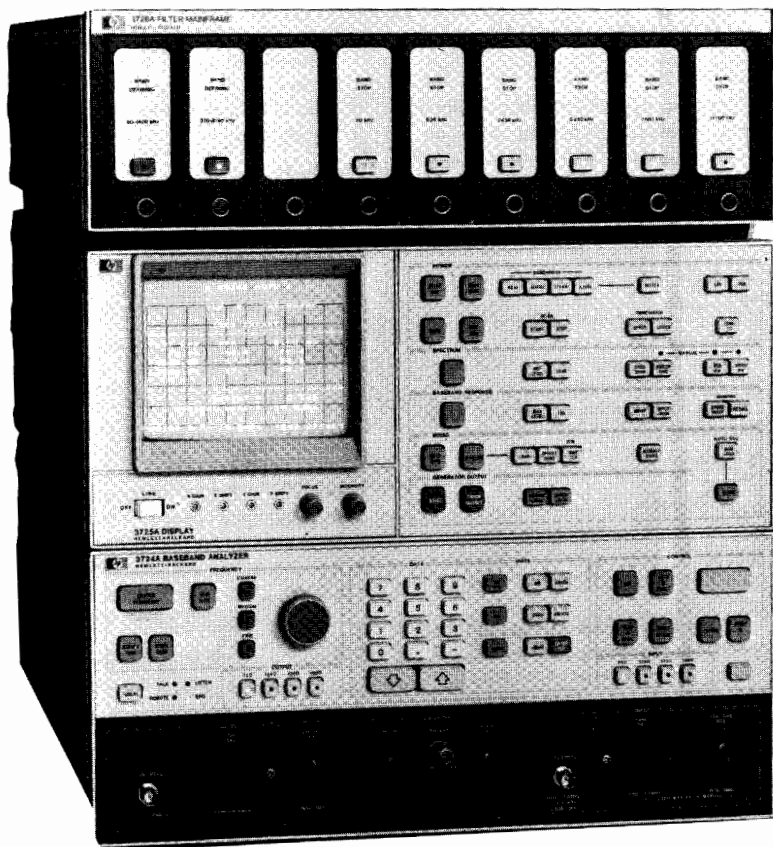

3726A Filter Mainframe with 37264A Band Defining Filter and 37265A Band Stop Filter plug-ins
3725A Display
3724A Baseband Analyzer

A new approach to microwave radio maintenance, the 3724A/3725A/3726A Baseband Analyzer provides in a single convenient, transportable package, all the qualitative measurements commonly performed on FDM microwave radio systems.

The full capability of the Baseband Analyzer covers measurements traditionally performed by stand-alone products such as a Selective Level Measuring Set (SLMS), Broadband Power Meter, Spectrum Analyzer, Tracking Generator, and White Noise Measuring Set. For the first time, these instruments have been integrated into a single product offering state-of-the-art features for ease-of-use, high performance, and cost effectiveness.

This measurement capability is enhanced by the ability to make complementary measurements on the same signal. For example, a spurious tone found using the Spectrum Analysis mode may have both its level and frequency accurately measured by changing to the SLMS mode. During the changeover, the tuned frequency is automatically retained.

All measurement results appear on a CRT in both analog and digital form, as appropriate. A hard copy of the information on the screen may be obtained using an X-Y plotter or a printer plotter via the HP-IB. No external controller is required for this function.

For portability, the Baseband Analyzer is manufactured in three separate cabinets. The basic instrument comprises two cabinets—the 3724A Baseband Analyzer and the 3725A Display module. Together they provide all the measurement capability except white noise generation. For white noise loading the third cabinet, the 3726A Filter Mainframe, must be added. The 3726A houses the white noise source, the 37264A Band Defining Filter plug-ins, and the 37265A Band Stop Filter plug-ins. Various bandwidths and frequencies to comply with CCIR, CCITT, Intelsat, and Bell recommendations can be provided as options. For the majority of white noise loading applications band pass filters, as required by conventional white noise receivers, are not required. However, if a noise power ratio performance better than 67 dB is required then 37266A Band Pass Filter plug-ins can be installed, offering a further 10 dB improvement in NPR.

Models 3724A, 3725A, 3726A (Cont.)

Measurement Summary

Level Measurements

Make accurate level and frequency measurements of pilots, carrier leaks, channel power, spurious tones, and other measurements associated with Frequency Division Multiplex (Carrier) systems.

Wideband

Frequency range: 20 Hz to 18.6 MHz.

Power range: ± 20 dBm to -76 dBm.

Accuracy: $< \pm 0.5$ dB.

Selective

Measurement bandwidths: 40 Hz; 400 Hz; 1.74 kHz; 3.1 kHz; psophometric; 'C'-message.

Frequency range: 50 Hz to 18.6 MHz.

Power range: $+20$ dBm to < -130 dBm.

Accuracy: $\leq \pm 0.2$ dB.

Frequency measurement: 0.1 Hz resolution.

Features

- Synthesizer Based Tuning—for frequency accuracy and stability.
- Scan Routines—enables sequences of measurements on pilots or channels within a supergroup; also tabulates frequency response when used with a tracking generator.
- Fast High Level User Routine—checks in 80 seconds a radio baseband of 1800 channels for signals above a specified level.

Spectrum Analysis

Make measurements on system traffic to check occupancy, or on unloaded systems to check for spurious signals.

Spectrum Analysis

Frequency range: 100 Hz to 20 MHz.

Amplitude range (2 dB or 10 dB/cm): $+20$ dBm to -130 dBm.

Dynamic range: 80 dB.

Frequency span: 20 MHz to 5 kHz.

Sweep time: 8 ms/div to 32 s/div.

Resolution bandwidth: 10 kHz to 100 Hz.

Video bandwidth: 5 kHz to 5 Hz.

Features

- Automatic or manual coupled controls ensure error free measurements along with flexibility.
- Digitally stored and refreshed CRT display—trace can be digitally stored and at a later time recalled for visual comparisons.
- CRT readout of all control settings.
- X-Y plots via the HP-IB—no external controller is required for this function.

BB Frequency Response Measurements

There are three methods of making frequency response measurements with the Baseband Analyzer, i.e. using the Power, Spectrum, or BB Response modes in conjunction with the tracking generator output.

Tracking Generator

Frequency range: 300 Hz to 18.6 MHz.

Amplitude range: $+6$ dBm to -60 dBm.

Flatness: < 0.2 dB.

Harmonics and spurious: < -40 dB on output level.

Using the Power and Spectrum modes for BB amplitude response testing offers wide display range coupled with fast response times. However, these modes are limited to local applications. In contrast, the BB Response mode offers:

- No connection needed between sender and receiver (apart from item under test).
- Automatic point-by-point measurements with results presented graphically.
- Trace storage and normalisation.
- Sweep time fast enough to allow adjustments.
- Display scaling of 1 or 0.1 dB per square.

White Noise Measurements

White noise measurements allow the overall performance of a radio link to be assessed using test signals which simulate normal traffic. The test signal used is white noise, band limited to correspond to the baseband bandwidth of the particular radio under test.

White Noise Measurements

Frequency range: for measurements on systems with 12 to 2700 channels.

Noise power ratio range: 0 to 67 dB.

Signal to noise range: -18.8 to -85 dBm0p (1.3×10^7 to 3.16 pW0p); 72 to 5 dBm0C (1.66×10^7 to 4 pW0c).

A full range of band defining and slot filters is available, consult Data Sheet.

Noise power range: $+12$ to -60 dBm.

Features

- Simultaneous measurement of broadband and slot power dispenses with repeated reference checking.
- Full range of filters easily changed from front panel.
- Auto mode allows automatic scan of up to four slots even on an end-end measurement.
- V curve and overload plotting made simple by offset key, or fully automate with an external controller.
- Measures all commonly used units, i.e. NPR, dBm0p, and dBm0C.
- Conforms to all relevant CCIR and CCITT Recommendations.

Options

3724A Baseband Analyzer

Input/Output	Standard	Option 003	Option 004
75 Ω	BNC	Siemens 1.6 mm	WECO 477B
124 Ω	Blank	Blank	WECO 477B
135 Ω /150 Ω	Siemens 3-pin Bal	Siemens 3-pin Bal	Large 223A
600 Ω Audio	Siemens 3-pin Bal	Siemens 3-pin Bal	Large 310
Head Phone	0.75" Banana	0.75" Banana	0.75" Banana

3726A Filter Mainframe

301: delete noise source (for systems where more than nine filters are required). N.B. Up to three 3726A Filter Mainframes can be controlled by one 3724A Baseband Analyzer.

37264A Band Defining Filter

311: 60 to 300 kHz. **315:** 60 to 4100 kHz. **318:** 316 to 5600 kHz.
312: 60 to 552 kHz. **316:** 316 to 4100 kHz. **319:** 316 to 8160 kHz.
313: 60 to 1296 kHz. **317:** 60 to 5600 kHz. **320:** 316 to 12360 kHz.
314: 60 to 2600 kHz.

N.B. All nine plug-in compartments of the 3726A Filter Mainframe must be filled for correct operation. The 37268A Dummy Plug-in should be ordered to fill any empty plug-in compartments.

37265A Band Stop Filter

311: 70 kHz. **314:** 1248 kHz. **317:** 5340 kHz.
312: 270 kHz. **315:** 2438 kHz. **318:** 7600 kHz.
313: 534 kHz. **316:** 3886 kHz. **319:** 11700 kHz.

37266A Band Pass Filter

Only required if a noise power ratio performance of better than 67 dB is required. NPR performance of instrument is extended to 77 dB when Band Pass Filter fitted. These filters must be housed in separate 3726A Filter Mainframe.

311: 70 kHz. **314:** 1248 kHz. **317:** 5340 kHz.
312: 270 kHz. **315:** 2438 kHz. **318:** 7600 kHz.
313: 534 kHz. **316:** 3886 kHz. **319:** 11700 kHz.

N.B. Consult Baseband Analyzer data sheet for Band Defining, Band Stop, and Band Pass Filters to meet Intelsat and Bell requirements.

37267A Adapter Case (for Marconi filters)

311: high or low pass.
313: band pass (including 750 Ω /75 Ω transformer).
314: band stop.

37268A Dummy Plug-in

Must be used to fill any empty plug-in compartments on the 3726A Filter Mainframe.

37269A Plug-in With Front Panel Input Connector

To be used in conjunction with 37266A Band Pass Filter.

003: Siemens 1.6 mm connector.

004: WECO 477B connector.

Ordering Information

3724A Baseband Analyzer

3725A Display

3726A Filter Mainframe

Prices

\$21685

\$15011

\$2670

TELECOMMUNICATIONS TEST EQUIPMENT

Baseband Analyzer System Software

Model 37018A

641



- Automate all baseband measurements
- Reduce test time in production, installation and maintenance
- Hard copy of all measurement results available

- Measurements checked against user input tolerances
- NPR 'V' curves plotted on HP 85 CRT and dumped to plotter
- Desired measurement sequence easily and quickly set up

The 37018A Baseband Analyzer System Software, together with an HP 85 or HP 83 Desktop Computer provides a means of automating Baseband Analyzer measurements. The program consists of two parts. The first is used to create a sequence file which consists of a list of measurements to be carried out together with all relevant measurement and tolerance information, while the second part uses the sequence file data to run the tests. Each measurement in the sequence

also stores two "next test numbers", the first of which defines the next test if the current test passes, while the second is used in the event of a failure. Thus, extra measurements may be incorporated to provide diagnostic information in the event of a failure of one of the primary tests. All measurement data is automatically checked for validity at the time of input, ensuring that only acceptable data is sent to the instrument.

```

Sequence File EXAMPL
Measurement Number 1
Wideband Power
Measurement Impedance 75ohms
Expected Level-21 dBm
Upper Limit 1 dB
Lower Limit 1 dB
Generator Output Level-21 dBm
Frequency 1234 kHz
TLP 0 dBr
Next measurement number IF PASS
(-1=HALT) 2
Next measurement number IF FAIL
(-1=HALT) 2

Measurement Number 2
Selective Power-Single
Measurement Impedance 75ohms
Expected Level-56.5 dBm
Upper Limit .5 dB
Lower Limit .5 dB
Generator Output Level-51.5 dBm
Frequency 4567 kHz
Measurement Bandwidth 400 Hz
TLP 0 dBr
Next measurement number IF PASS
(-1=HALT) 3
Next measurement number IF FAIL
(-1=HALT) 3

Measurement Number 3
NPR-Single
Measurement Impedance 75ohms
Expected Level 65 dBm
Limit 1 dB
Generator Output Level-15 dBm
Band Defining Filter Position
Mainframe # 1
Position # 2
Slot Filter Position
Mainframe # 1
Position # 9
Slot Frequency 5340 kHz
Channel Capacity 1800
TLP 0 dBr
Next measurement number IF PASS
(-1=HALT) 5
Next measurement number IF FAIL
(-1=HALT) 4

Measurement Number 4
Spectrum
Measurement Impedance 75ohms
Reference Level-50 dBm
Resolution Bandwidth AUTO
Video Bandwidth AUTO
Display Resolution 10 dB/div
Frequency 5340 kHz
Span Width 5000 kHz
Sweep Time AUTO
Next measurement number
(-1=HALT) -1

Measurement Number 5
NPR-Single
Measurement Impedance 75ohms
Expected Level 65 dBm
Limit 1 dB
Generator Output Level-15 dBm
Band Defining Filter Position
Mainframe # 1
Position # 2
Slot Filter Position
Mainframe # 1
Position # 7
Slot Frequency 1248 kHz
Channel Capacity 1800
TLP 0 dBr
Next measurement number IF PASS
(-1=HALT) 7
Next measurement number IF FAIL
(-1=HALT) 6
    
```

Sequence file "EXAMPL"

```

Measurement Number 1
Wideband Power
Impedance 75 ohm
TLP 0 dBr
Expected Level-21 dBm
Upper Limit 1 dB
Lower Limit 1 dB
Next Measurement - PASS 2
Next Measurement - FAIL 2
Generator Level -21 dBm
Frequency 1234 kHz
Result -21.17 dBm
*** PASS ***

Measurement Number 2
Selective Power - Single
Impedance 75 ohm
TLP 0 dBr
Expected Level-56.5 dBm
Upper Limit .5 dB
Lower Limit .5 dB
Next Measurement - PASS 3
Next Measurement - FAIL 3
Generator Level -51.5 dBm
Frequency 4567 kHz
Measurement Bandwidth 400 Hz
Result -51.63 dBm
*** FAIL ***

Measurement Number 3
NPR - Single
Impedance 75 ohm
Generator Level-15 dBm
Band Defining Filter Position
Mainframe # 1
Position # 2
Slot Frequency 5340 kHz
Slot Filter Position
Mainframe # 1
Position # 9
Next Measurement - PASS 5
Next Measurement - FAIL 4
Result 71 dB
*** PASS ***

Measurement Number 5
NPR - Single
Impedance 75 ohm
Generator Level-15 dBm
Band Defining Filter Position
Mainframe # 1
Position # 2
Slot Frequency 1248 kHz
Slot Filter Position
Mainframe # 1
Position # 7
Next Measurement - PASS 7
Next Measurement - FAIL 6
Result 71.2 dB
*** PASS ***
    
```

Result of running "EXAMPL" with measurement 3 passing

```

Measurement Number 1
Wideband Power
Impedance 75 ohm
TLP 0 dBr
Expected Level-21 dBm
Upper Limit 1 dB
Lower Limit 1 dB
Next Measurement - PASS 2
Next Measurement - FAIL 2
Generator Level -21 dBm
Frequency 1234 kHz
Result -21.17 dBm
*** PASS ***

Measurement Number 2
Selective Power - Single
Impedance 75 ohm
TLP 0 dBr
Expected Level-56.5 dBm
Upper Limit .5 dB
Lower Limit .5 dB
Next Measurement - PASS 3
Next Measurement - FAIL 3
Generator Level -51.5 dBm
Frequency 4567 kHz
Measurement Bandwidth 400 Hz
Result -132.98 dBm
*** FAIL ***

Measurement Number 3
NPR - Single
Impedance 75 ohm
Generator Level-15 dBm
Band Defining Filter Position
Mainframe # 1
Position # 2
Slot Frequency 5340 kHz
Slot Filter Position
Mainframe # 1
Position # 9
Next Measurement - PASS 5
Next Measurement - FAIL 4
Result -1 dB
*** FAIL ***

Measurement Number 4
Spectrum
Impedance 75 ohm
Reference Level-50 dBm
Display Resolution 10 dB/Div
Resolution Bandwidth AUTO
Video Bandwidth AUTO
Sweep Time AUTO
Centre Frequency 5340 kHz
Frequency Span 5000 kHz
Next Measurement - 1
    
```

Result of running "EXAMPL" with measurement 3 failing

TRANSCIVER TEST EQUIPMENT

Automatic RF Test System
Model 8950B



- Designed for AM, FM and ϕ M transceivers from 2 to 1000 MHz
- Automatically test RF modules and subassemblies
- Component stimulus/response test from dc to 1000 MHz



8950B RF Test System

The HP 8950B Transceiver Test System automatically tests AM and FM communications transceivers over the frequency range of 2 to 1000 MHz. It is ideal for production line testing, R & D evaluation, quality assurance testing, incoming inspection, and user maintenance of many transceivers. The system consists of general purpose, off-the-shelf instruments except for the 8951B System Interface. The HP 9825B desk top computer controls the stimulus and measurement capabilities of the system via the HP Interface Bus (HP-IB). Using the 8950B system, transceiver testing time can typically be reduced by a factor of 10 or more, resulting in greatly increased productivity.

Operation of the 8950B under computer control offers better accuracy than a manual system. By automatically applying previously measured calibration factors, repeatable system errors such as frequency response and insertion loss are virtually eliminated.

8951B System Interface

The 8951B System Interface contains all the signal switching and conditioning needed to route signals to and from the proper instruments and the radio under test. All radio connections are made at a single working panel.

In addition to switches, the 8951B includes a 100 watt RF attenuator, a high quality FM discriminator, and a diode detector for AM measurements. Three band-reject filters with provision for an external filter are used for distortion and SINAD measurements.

System Software

The system is controlled by the 9825B Desktop Computer. It employs HPL, a high-level programming language which offers power and efficiency for handling equations and controlling instruments, yet is easy to learn and use.

To perform a series of tests on a transceiver, a program must be written for the 9825B which accesses the appropriate measurement and instrument driver subroutines. Additional program statements will provide a printed copy of the results which can include the chosen test limits or a Pass-Fail indication of total test performance. Because of the software flexibility, special tests can easily be written using the instrument drivers provided with the system.

The 8950B is furnished with a tape cartridge containing a comprehensive library of system programs: 1) the verification program is a short system self-test, 2) the calibration program generates calibration factors to correct repeatable errors in the system, 3) and the mea-

surement subroutines allow complex measurements to be made by writing only a single statement.

8950B System Specifications (Includes Software Calibration)

System frequency range: 1-1000 MHz.

System power range: 0.5 - 100 watts.

Calculator controlled power supply voltages: 0 to 30 V, 50 mV resolution.

Current drain measurement range: 50 mA to 10 A.

Transmitter Tests

Power measurement range (Antenna port): 1 mW to 100 watts.

Power measurement range (AUX RF Input): 10 μ W to 1 watt.

Power measurement accuracy (Antenna port): expected ± 0.3 dB $\pm 7.2\%$.

Frequency measurement range: 0 to 1300 MHz.

AM measurement

Frequency range: 2-400 MHz.

AM depth range: 0.5 to 95%.

AM accuracy (1 kHz rate 10% to 80%): $\pm 2\%$ AM DEPTH $\pm 5\%$ of reading.

AM rate range (3 dB): 50 Hz - 25 kHz.

AM residual distortion (at 30% AM): (at 400 Hz, 1 kHz, 3 kHz rates): $\leq 2\%$

FM measurement (positive and negative peak detection)

Frequency range: 4-1000 MHz.

Peak deviation range: 300 Hz - 20 kHz.

System residual: < 10 Hz in 1 kHz BW.

FM accuracy (1 kHz rate): $\pm 3\% \pm 30$ Hz.

FM rate range (3 dB): 50 Hz - 20 kHz.

FM residual distortion (at ≥ 3 kHz peak deviation at 400 Hz, 1 kHz, 3 kHz rates): $\leq 1.0\%$.

ϕ M measurement

Frequency range: 4 - 1000 MHz.

Deviation: $\Delta\phi_{max} = 20/\text{mod. rate (kHz)}$.

ϕ M rate range: 50 Hz - 20 kHz.

ϕ M accuracy (1 kHz rate): $\pm 3\%$.

Spurious measurements (> 1 MHz away from carrier): 0 to -40 dBc.

Receiver Tests

Minimum measurable sensitivity (typical): 0.2 μ V.

Output level range (Antenna port, into 50 ohms): -145 to -19 dBm (~ 0.013 μ V to 25 mV).

Output level accuracy (1 to 1000 MHz, at Antenna port): ± 1.5 dB.

Audio power measurement accuracy: 0.5% \pm speaker load tolerance.

Audio distortion measurement: At 400, 1000, and 3000 Hz rates.

Residual distortion: RF generator distortion +0.3%.

Audio frequency range:

AM: 50 Hz to 50 kHz (RF freq > 10 MHz)

FM: 50 Hz to 100 kHz.

Modulation acceptance bandwidth measurement range: 1 to 100 kHz.

Ordering Information

8950B Transceiver Test System (including controller and programs) \$66,000

8950B Options

002: Additional Power Supply capability (Substitute 6268B Option 026/J80 and 59501A for 6002A) add \$650

003: Reduced frequency (110 MHz) less \$4500

004: 230 V, 50 Hz operation N/C

005: Delete 9825B Controller and HP-IB interface less \$8100



8903A-E85 Semi-Automatic Transceiver Test Set

The 8903A-E85 Semi-Automatic Transceiver Test Set performs in-channel testing of AM, FM and ϕ M communication transceivers from 150 kHz to 990 MHz (Table 1). The test set's measurement capabilities range from simple tests such as frequency and distortion through complex measurements such as usable sensitivity and audio flatness. Automated in-channel radio tests using the test set's Application Pac test procedures typically take less than a minute. Being a combination of standard HP instruments, it can be assembled from on-hand instruments and purchased items from the equipment list, or obtained as a complete test set.

Out-of-Channel Testing

The 8903A-E85 Test Set's capabilities are expandable to include out-of-channel receiver measurements. The addendum to Application Note 300 "Adding the 8662A to the 8903A-E85" describes how to add the low phase noise 8662A Synthesized Signal Generator to the 8903A-E85 Test Set. The resulting 8903A-E62 test set has all of the capabilities of the 8903A-E85, plus the tests listed under "Receiver Out-of-Channel" in Table 1.

High Performance Instruments

The test set's three key components—the 8903A Audio Analyzer, 8901A Modulation Analyzer, and the 8656A Synthesized Signal Generator—are general purpose fully HP-IB programmable instruments. For example, the 8901A Modulation Analyzer measures AM depth or FM deviation with 1% accuracy in less than two seconds with a single front-panel key stroke or a single instruction from the test set's HP 85F Instrument Controller. Using the HP 85F, the test set combines its instruments' measurement capabilities to quickly perform more complex measurements such as transmitter microphone sensitivity or receiver audio flatness.

Easy-to-Operate

The instruments automatically perform most intermediate operations for making transceiver measurements, from tuning and ranging to the input signals to displaying the results in the units desired. Front-panel annunciators continuously indicate the measurement modes in use, so the operator can monitor the state of the instruments at all times.

To provide the necessary switching the 8903A-E85/62 Test Set includes the 8903A-K85 Switching Module and the 59306A Relay Actuator. These instruments interface the transceiver under test to the test set instruments. They are controlled remotely by the HP 85F or manually from the 59306A's front panel.

Easy-to-Assemble

Application Note 300 describes the simple setup and verification procedure, and describes how to use the supplied 11723A Application Pac software cassette. This starter software contains a main program plus instrument, measurement, and utility subroutines—a modular structure that is easily adapted to specific applications. You only need to provide a power supply for the transceiver under test and the cables between the 8903A-K85 Switching Module and the transceiver. Everything else is included.

Equipment List, 8903A-E85

- 8901A Modulation Analyzer, Option 001 Rear Panel Connections, Option 002 High Stability Time Base
- 8903A Audio Analyzer, Option 001 Rear Panel Connections
- 8656A Signal Generator, Option 002 Rear Panel Connections
- HP 85F Instrument Controller
- 8903A-K85 Switching Module
- 59306A Relay Actuator
- 8498A Option 030 Attenuator, 25 watt, 30 dB
- 10833A Low-RFI HP-IB Cables (3)
- 11500B 60 cm N Cables (2)
- 11035A 30 cm BNC-Banana Cable (1)
- 11170A 30 cm BNC Cable (1)
- 11170B 60 cm BNC Cables (2)
- 11170C 120 cm BNC Cables (2)
- 11723A Application Pac Program Cassette

Table 1. Basic Transceiver Measurements

Receiver In-channel	Transmitter	General
Sensitivity*	Power*	AC volts
Audio Power*	Frequency*	DC volts
Signal-to-Noise*	Frequency Error*	Frequency
Distortion*	AM, FM, ϕ M	Distortion
SINAD	Squelch Frequency*	
Quieting	Squelch Deviation*	
Audio Freq. Response*	Residual AM, FM, or ϕ M	
Hum and Noise	Incidental AM, FM, or ϕ M	
	Microphone Sensitivity*	
Receiver Out-of-channel	Distortion*	
	Modulation Limiting*	
Adjacent channel selectivity**	Audio Flatness	
Image rejection**	Hum and Noise*	
IF rejection**		

*Tests performed and displayed by the 8903A-E85/E62 Test Set using the 11723A Application Pac starter programs. Additional subroutines are provided for the other measurements.

**Additional tests performed and displayed by the 8903A-E62 Test Set. Subroutines for these measurements are provided with the 8903A-E85 Test Set.

Ordering Information

	Price
8903A-E85 Semi-Automatic Transceiver Test Set	\$30,600
8903A-E62 Semi-Automatic Transceiver Test Set	\$62,975
Separate 8903A-K85 Switching Module	\$1,600
Separate 11723A Application Pac	\$100
8903A-K52 Combining Cases (for E85)	\$2,000

COMPUTERS, PERIPHERALS & CALCULATORS

General Information

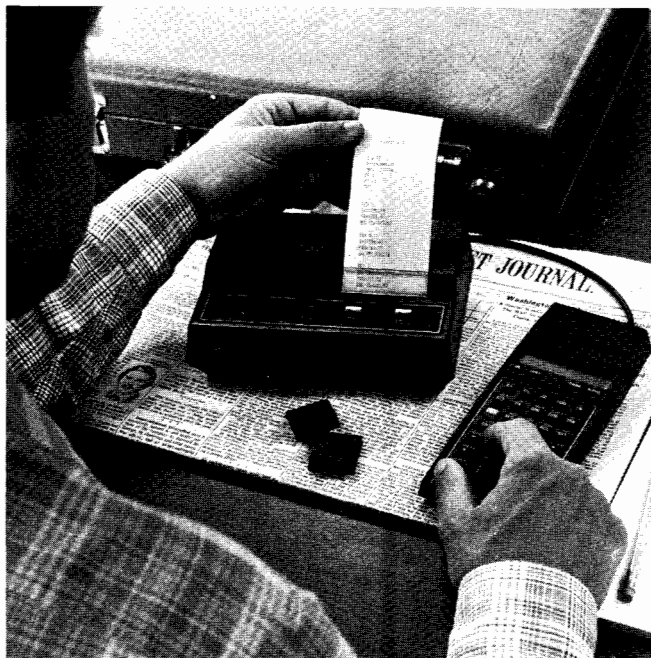

Hewlett-Packard offers a complete line of computational products ranging from inexpensive hand-held calculators and personal computers to multiple-user, multiple-language computer systems. These computational products can be grouped into five major categories: handheld calculators, personal and desktop computers, technical computer systems, business computer systems, and computer peripheral products. Each product group is focused on helping a particular type of customer solve his specific measurement and/or computational problem.

Programmable and non-programmable calculators are available for both scientific/engineering and business applications.

Personal and desktop computers are designed for professionals who may not be sophisticated computer analysts, but need easy-to-use computer power at their fingertips to solve scientific and engineering problems requiring data acquisition and control, technical computation, and graphics and capabilities.

The HP 1000 series of technical computer systems are designed to solve larger scientific and engineering applications requiring intensive computation, instrumentation, and distributed system capabilities. The HP 1000's range in size from computers-on-a-board to complete systems integrated with instruments and peripherals.

HP's business computer systems range from personal computers to assist individual businessmen improve their effectiveness to larger multi-user systems designed specifically for terminal-oriented business data processing in stand alone or sophisticated distributed processing environments.

In addition to its computers, HP offers a complete line of terminals and peripherals which are compatible with its computational products. These peripherals includes CRT

and hard copy terminals, digitizers, plotters and sophisticated laser printing systems.

Support of our computer customers is extremely important to us. HP has defined a full range of customer support capabilities ranging from the ability to purchase computer supplies directly from our warehouse to a full complement of support products ranging from user training courses to dedicated on-site support. It is possible for a customer to define specifically his own support program by ordering a unique combination of standard HP computer support products.

Handheld Calculators

Hewlett-Packard offers a wide range of calculators for both technical and financial applications. Each different model has its own set of unique features designed to solve particular problems. Common to all models is the standard excellence by design. The use of RPN logic, Continuous Memory and the unparalleled HP support system are but a few examples of this effort.

Since the introduction of HP's first calculator in 1972, its RPN logic system has achieved universal acceptance as being the most powerful and efficient logic system for solving complex problems. The logical and consistent methodology of RPN, as well as its superior speed in operation, make it unsurpassed in user satisfaction.

In 1976 Hewlett-Packard pioneered Continuous Memory for handheld calculators and today HP's CMOS technology prevails as a standard in the industry. With the CMOS feature, frequently needed calculations and functions can be programmed once and remain intact even when the calculator is turned off. It saves time by eliminating program reloading and makes possible the addition of specialized functions. Added to these features is a user support system unequaled in the industry. HP handbooks and owner's literature have long been respected for being

clear, thorough, and easy to understand. The same is true of HP's extensive line of software.

Personal & Desktop Computers

HP personal & desktop computers are designed for scientific/engineering problems that are too complex for calculators or that require peripherals or interfacing capabilities for data acquisition or instrumentation control. These self contained portable systems provide computing power when and where you need it. They have full high-level programming languages, much larger memories than calculators, built-in mass storage devices and I/O ports for interfacing to peripherals or other instruments. Some have impressive graphics capabilities for plotting, drawing, graphing and lettering.

With large memories (up to 449K bytes user read/write), powerful language, built-in mass storage, versatile I/O and high-speed processors, desktop computers are powerful problem solvers and true computers. But they are built with a turn-me-on-I'm-ready-to-go simplicity that makes them easy to operate and program, even if you've never been near a computer before. They're specifically designed to provide computer power to professional people whose profession is not computer programming, but who have technical problems to solve.

Many types of software development can be much faster and less expensive on a desktop computer because of operating-system features such as interpretive language; interactive syntax checking, editing and debugging; automatic tracing and automatic variable allocation.

Applications involving the desktop computer's capability to interface with instruments that measure and record electrical, mechanical or physical measurements fall into the area commonly called data acquisition and control. Such applications range from acquiring data from instruments that



convert analog output from transducers into the digital information a computer can handle, to gathering and processing statistical data for quality control or trend determination, to radioimmunoassay and blood gas analysis in the clinical laboratory.

In production test applications, a desktop computer can gather test data showing compliance with published specifications and convert it to a permanent record. In monitoring temperature and humidity in a manufacturing plant, a desktop computer can help plant engineers balance environmental conditions for maximum energy conservation and worker comfort. In the clinical laboratory, a desktop computer system allows the technician to identify and reject bad data to maximize the accuracy of resulting log and logit curves.

Quality control data monitoring can identify the point at which vendor items must be rejected, or testing must be changed from sampling to 100% to assure acceptable products. Using this data, the desktop computer system can generate reports that identify yield rates and causes of failure. These reports allow management to locate problems before they affect product quality.

The desktop computer system designer, who can also be the programmer without needing special computer training, can create systems with a wide range of capability and automation. Transducers are available to convert nearly any measurable parameter, such as temperature, pressure, humidity, velocity, distance, turbidity and pH into digital quantities that can be measured and compared to limits or recorded for permanent files. When physical or electrical parameters must be continuously monitored, analyzed and controlled, the desktop computer system can do this economically, saving many hours of manual testing, analysis and record keeping.

Hewlett-Packard personal desktop computers offer a spectrum of capabilities for data acquisition and control applications. The 97S is an economical unit affording control using a BCD interface code. The HP85 is Hewlett-Packard's personal computer for professionals and it can also interface to instruments and computer peripherals. The 9815, 9826, 9835 and 9845 can interface with peripherals and other devices using HP-IB (Hewlett-Packard's implementation of IEEE-488), BCD, RS-232-C or bit-parallel. A real-time clock interface providing real-time reference and time-related control activities is also available for the 9826, 9835 and 9845. With this range of interfacing capabilities, a large variety of data acquisition and control system designs is possible and they can be supported with color graphics available on the 9845C.

Technical Computer Systems

HP 1000 Computers and Computer Systems are aimed at applications in science, engineering, and manufacturing. Typical uses are modeling, instrument control, graphics, factory automation, and scientific analysis. To fit particular situations with precision, HP 1000s are offered at four levels of speed

and power. M-Series are for cost-critical purposes, E-Series have about twice as much speed and power, and F-Series models add more precision and speed with hardware floating-point operations and a range of other performance-accelerating options. Semiconductor main memory may be as large as 2 M bytes.

The HP 1000 L-Series uses the concept of distributed system architecture to permit I/O processing to occur concurrently with CPU processing to improve overall system throughput for I/O intensive applications. Further to fit individual needs, they are available as circuit boards alone, in boxes, or in a range of complete computer systems.

All 1000's are multi-lingual, multi-programming systems capable of supporting multiple terminals. They are user-microprogrammable for further adaptability to special uses. Real-time executive operating systems readily implement efficient programming for scientific and engineering applications. Application tools now include a modern, friendly data-base management capability (IMAGE/1000 with QUERY), a menu-driven factory data collection system (DATACAP/1000) that can be set up with a minimum of user programming, and GRAPHICS/1000 software to do 3-D graphics as well as speed production of graphs, charts, and diagrams. Languages include BASIC, FORTRAN and PASCAL. With HP Distributed Systems Network software and hardware, HP 1000s can be interconnected in an almost unlimited variety of network configurations, sharing files, programs and other resources with great ease. HP 1000s may similarly be interconnected with HP 3000 networks.

Business Computer Systems

Especially well-suited for on-line, interactive, distributed processing applications, HP business computers are offered in three series. The HP 125 Business Assistant is a personal computer to help improve the effectiveness of a business manager. It features word processing, VisiCalc™, graphics and distributed system capabilities. The HP 250 is a low-priced computer with full database management capability and other powerful software tools for developing applications. With these, value may be economically added by suppliers who tailor computer solutions for small businesses, and by larger users needing systems that are easy to dedicate to particular functions.

The HP 3000 is a family of totally compatible systems, sharing the same multiprogramming executive operating system (MPE), the same languages, and able to run one another's programs interchangeably. Today, this evolving family's fastest and most expandable system is the HP 3000 Series 44, with main memory to 4 megabytes, and ability to support as many as 96 terminals, each running or developing separate programs. The SOS-based HP 3000 Series 33 and 30, at less cost, offer much the same ability to handle simultaneously many transaction-processing, time-sharing, program-development, and batch operations in any of five high-

VisiCalc™ is a trademark of Personal Software Inc.

level languages, COBOL, RPG, BASIC, FORTRAN, and SPL (the HP systems programming language). All may be interconnected so as to command one another's resources readily, sharing files and programs, with HP Distributed Systems Network DS/3000 hardware and software that also can integrate HP 3000s with HP 1000 networks.

Computer Peripheral Products

Hewlett-Packard is a single source not only for computers, but for the majority of peripherals used with HP systems. These peripherals include micro-processor-controlled CRT terminals equipped with built-in mass storage and specialized graphics capabilities. Additionally, HP offers a range of printers which utilize both traditional (drum/chain/band/impact and dot matrix impact) and non-traditional (laser) technologies.

The HP 2680 Laser Printing System (LPS) offers users high quality output that is easily tailored to individual user's needs. The unique capabilities of the 2680A provide cost-effective solutions to a wide range of printing applications. The LPS combines the 2680A Intelligent Page Printer and two powerful application software packages. The two software packages allow users throughout an organization to take advantage of the unique print quality and flexibility of the HP 2680A Intelligent Page Printer. The Interactive Design System (IDS/3000) is used for design of characters, symbols, and forms at a graphics terminal. This easy to use, menu-driven software interacts with an HP 2647A or HP 2648A graphics terminal to create any desired image. Optionally, an HP 9874A digitizer can be used to facilitate creation of characters, logos, or symbols. The Interactive Formatting System (IFS/3000) is used to configure output tailored to each user's needs. Character fonts, logos, symbols, forms and even signatures designed with IDS/3000 can be selected for use in any printing application. In addition, more than 40 predefined character sets are supplied with the formatting software. The IFS/3000 software allows users to specify which character sets and forms are to be used in a printing application, and how they are to be positioned on each page. An HP 3000 computer provides data base management, spooling, and intrinsics that may be called from a user's program. Once the desired format has been defined using IFS/3000 it can be electronically downloaded to the printer. Application data is merged with the predefined electronic format on the HP 3000 to produce the desired output.

In addition to the wide range of printers available, monochrome and color plotters, disc memories ranging to 120 megabyte capacity, magnetic tape, and digitizer equipment are all manufactured by the company. The fact that Hewlett-Packard peripherals are compatible with HP personal desktop computers, HP technical and business computer systems, and with the equipment of many other manufacturers makes Hewlett-Packard truly a one-vendor solution for many customers.



COMPUTERS, PERIPHERALS & CALCULATORS

Personal Computation

Models HP-12C, HP-37E, HP-38C

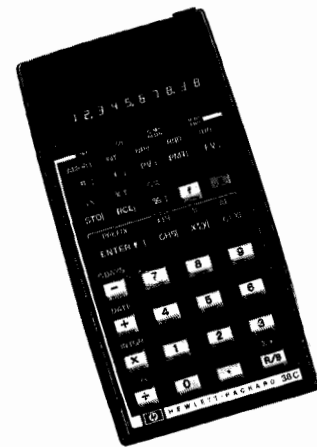
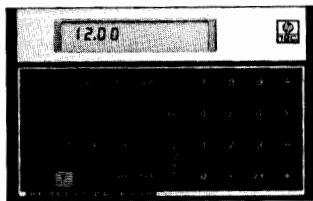

Why a Professional Calculator?

Proper selection of a calculator depends largely on careful analysis of your current personal and professional needs, plus those you're likely to face in the future. HP calculators have the most needed and useful functions preprogrammed into the calculator, so, most simple problems are solved at the touch of a key. And you can write your own programs or choose from prewritten programs for today's solutions and tomorrow's too.

HP-12C Slim-Line Financial Programmable with Continuous Memory and Special Functions

At four ounces light and half an inch slim, the HP-12C puts more financial solutions in your pocket than ever before. With its special functions, programmability, Continuous Memory, and liquid crystal display, this calculator is ideal for solving most business and financial problems in or out of the office. The HP-12C features basic time and money functions, NPV, IRR, plus a bond function which calculates yield-to-maturity and price. For additional push-button solutions, you can write your own programs, or, take advantage of HP's prewritten software solutions for specific applications.

The HP-12C comes complete with a detailed Owner's Handbook and Problem-Solving Guide; long-life disposable batteries; and a soft carrying case.

HP-12C Specifications

Financial Functions: n, i, PV, PMT, FV, amortization (accumulated interest and remaining balance), simple interest, NPV, IRR, bond yield-to-maturity and price, depreciation (straight-line, declining-balance, sum-of-years' digits), odd days' interest, beginning/end of period selection.

Mathematical Functions: +, -, \times , \div , y^x , \sqrt{x} , $1/x$, x^2 , LN, e^x , round, integer/fraction truncation.

Statistical Functions: %, $\Delta\%$, %T, \bar{x} , s, \hat{y} , \hat{x} , r, summation (n, Σx , Σx^2 , Σy , Σy^2 , Σxy), factorials.

Calendar Functions: 2000-year calendar, finds number of days between two dates, day of week, future or past date, all on 360- or 365-day calendar basis.

Programming Features: SST, BST, GTO, R/S, pause, two conditional tests ($x=0$, $x\leq y$).

Clearing Options: CLEAR X, FINANCIAL, STATISTICAL, PREFIX, PROGRAM, REGISTERS.

Memory: five financial registers, four-register stack, last-x register, automatic memory allocation between storage registers and program memory. A maximum of 99 program lines and 7 registers or 8 program lines and 20 storage registers.

Size: 12.7 × 8.0 × 1.5 cm (5 × 3 1/8 × 3/8 in).

HP-37E Business

The HP-37E is the basic financial calculator for most business and financial problems. In addition to built-in price, percent, and statistical functions, the HP-37E features the basic time and money functions. HP has developed a number of specific application books that address a variety of financial problems.

The HP-37E comes complete with a detailed Owner's Handbook; the informative "Your HP Financial Calculator: An Introduction to Financial Concepts and Problem Solving"; recharger/AC adapter; rechargeable battery pack; soft carrying case; and your choice of one of the optional application books.

HP-37E Specifications

Financial Functions: n, i, PV, PMT, FV, amortization (accumulated interest, payment to principal, remaining balance), begin/end switch for ordinary- or annuity-due problems.

Mathematical Functions: +, -, \times , \div , $1/x$, \sqrt{x} , y^x , LN, e^x .

Statistical Functions: %, $\Delta\%$, %T, price, \bar{x} , s, r, L.R., \hat{x} , \hat{y} , $\Sigma+$, $\Sigma-$, summations (n, Σx , Σx^2 , Σy , Σy^2 , Σxy), factorials.

Clearing Options: CLEAR X, FINANCIAL, ALL.

Memory: 7 storage registers, 5 financial registers, 4-register stack.

Recharger Power Requirements: 90 to 120 Vac or 198 to 242 Vac (50 to 60 Hz).

Size: 30 × 75 × 140 mm (1.2 × 3.0 × 5.6 in).

HP-38C Advanced Financial Programmable with Continuous Memory

The HP-38C combines a wide array of financial functions with Continuous Memory, which allows you to retain data and programs even when the calculator is turned off. This calculator has the advanced financial capability of discounted cash flow as well as basic time and money functions. You can create your own programs or choose from several application books containing prewritten programs.

The HP-38C comes complete with a detailed Owner's Handbook; the informative "Your HP Financial Calculator: An Introduction to Financial Concepts and Problem-Solving"; recharger/AC adapter; rechargeable battery; quick reference card; soft carrying case; and your choice of one of the optional application books.

HP-38C Specifications

Financial Functions: n, i, PV, PMT, FV, amortization (accumulated interest and remaining balance), simple interest, NPV, IRR, automatic entry for grouped or individual cash flows, begin/end switch for ordinary- or annuity-due problems.

Mathematical Functions: +, -, \times , \div , $1/x$, \sqrt{x} , y^x , LN, e^x , round, integer/fraction truncation.

Statistical Functions: %, $\Delta\%$, %T, \bar{x} , s, r, L.R., \hat{x} , \hat{y} , summations (n, Σx , Σx^2 , Σy , Σy^2 , Σxy), factorials.

Calendar Functions: 2000-year calendar, finds number of days between two dates, day of week, future or past date, all with 366- or 365-day calendar basis, M.D.Y. \leftrightarrow D.M.Y.

Programming Features: SST, BST, GTO, R/S, pause, two conditional tests ($x=0$, $x\leq y$).

Clearing Options: CLEAR X, FINANCIAL, STATISTICAL, PREFIX, PROGRAM, ALL.

Memory: 5 financial registers, 4-register stack, last-x register. Dynamic memory allocation between storage registers and program memory.

Recharger Power Requirements: 90 to 120 Vac or 198 to 242 Vac (50 to 60 Hz).

Size: 30 × 75 × 140 mm (1.2 × 3.0 × 5.6 in).

Ordering Information

	Price
HP-12C	\$150.00
HP-37E	\$75.00
HP-38C	\$150.00
HP-12C Solutions Handbook	\$20.00
HP-37E or HP-38C Optional Solutions Books	\$5.00

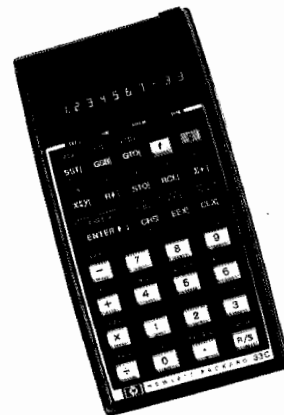
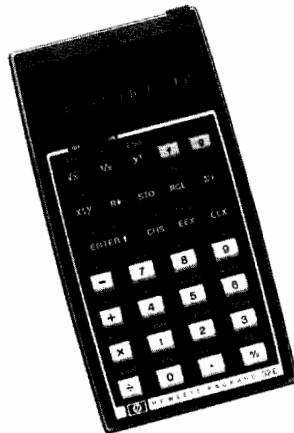
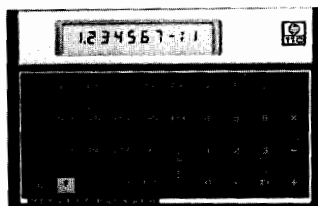

HP-11C Slim-Line Advanced Programmable Scientific with Continuous Memory

Hewlett-Packard's newest scientific programmable is four ounces light and half an inch slim. This powerful slim-line calculator comes with long-life disposable batteries and an easy-to-read liquid crystal display. Your HP-11C gives you shirt-pocket solutions when and where you need them.

Programming on the HP-11C is easy to learn and easy to use. You can master its fundamentals quickly, using the Owner's Handbook and then modify your work with powerful HP-11C editing features. The HP-11C has subroutine and indirect addressing capability, conditional tests and flags. Insert new instructions by using the "Go To" key to access any part of your program. Delete a program line instantly by pressing the Backarrow key. Other editing functions let you step through a program one line at a time, so you can make changes or test program execution line by line. And, the convenient user mode saves time and keystrokes—at the touch of a single key, branch to any one of five independent programs. Even add the unpredictable to your work or programmed games with the random number generator.

The HP-11C also offers an extended function set that provides push-button answers for two-variable statistics, trigonometrics, including hyperbolics, permutations and combinations, and more.

The HP-11C comes complete with Owner's Handbook and Problem-Solving Guide, long-life disposable batteries, and a soft carrying case.

HP-11C Specifications

Mathematical Functions: SIN, COS, TAN, and inverses, SINH, COSH, TANH, and inverses, DEG, RAD, GRAD, R \rightleftharpoons P, DEG \rightleftharpoons RAD, H \rightleftharpoons H.MS, 10^x , log, LN, e^x , y^x , \sqrt{x} , x^2 , $1/x$, π , +, -, \times , \div , ABS, integer/fraction truncation, round.

Statistical Functions: \bar{x} , \bar{y} , s, r, L.R., $x!$, P_y, x ; C_y, x ; $RAN\#$, \hat{y} , r , summations (n , Σx , Σx^2 , Σy , Σy^2 , Σxy), Gamma functions.

Programming Features: label addressing, 5 user-definable keys and 15 labels; indirect addressing of labels, data storage, program lines; 4 levels of subroutines, controlled looping, 2 flags, 8 conditional tests ($x=0$, $x\neq 0$, $x>0$, $x<0$, $x=y$, $x\neq y$, $x\leq y$, $x>y$); editing operations include singlestep execution, single- and backstep inspection of a program, insert/delete editing, user mode, positioning the calculator at any step in program memory, pause, conditional and unconditional branching, backarrow, GTO.

Clearing Options: CLEAR X, REGISTERS, Σ , PROGRAM, PREFIX.

Display: fixed decimal, scientific, and engineering notation, display mantissa, commas or periods separate thousands.

Memory: 4-register stack, last-x register, automatic memory allocation for 203 program lines and 1 register (index register), or 21 program lines and 63 storage registers.

Size: 12.7 \times 8.0 \times 1.5 cm (5 \times 3 $\frac{1}{8}$ \times $\frac{5}{16}$ in).

HP-32E Scientific with Statistics

Designed specifically for the scientist, engineering professional and student who need to solve complex problems involving trigonometry, logarithms, or statistics—all at the touch of a key. The HP-32E includes statistical functions such as normal distribution, summations,

two-variable means and standard deviations, linear regressions, and correlation as well as percent calculations. Equipped with 9 user plus 6 statistical storage registers, the HP-32E is powerful and accurate, yet easy to use.

The HP-32E comes complete with an Owner's Handbook; the informative "Solving Problems with Your Hewlett-Packard Calculator"; recharger/AC adapter; rechargeable battery pack and soft carrying case.

HP-32E Specifications

Mathematical Functions: SIN, COS, TAN, and inverses, DEG, RAD, GRAD, R \rightleftharpoons P, DEG \rightleftharpoons RAD, H \rightleftharpoons H.MS, SINH, COSH, TANH, and inverses, log, 10^x , LN, e^x , y^x , \sqrt{x} , x^2 , $1/x$, π , +, -, \times , \div .

Statistical Functions: \bar{x} , \bar{y} , s, r, L.R., \hat{x} , \hat{y} , $\Sigma+$, $\Sigma-$, summations (n , Σx , Σx^2 , Σy , Σy^2 , Σxy), $n!$, Q , Q^{-1} .

Clearing Options: CLEAR X, REGISTERS, Σ , ALL, PREFIX.

Memory: 15 storage registers, 4-register stack, last-x register.

Recharger Power Requirements: 90 to 120 Vac or 198 to 242 Vac (50 to 60 Hz).

Size: 30 \times 75 \times 140 mm (1.2 \times 3.0 \times 5.6 in).

HP-33C Programmable Scientific with Continuous Memory

The HP-33C provides fundamental programming as well as extraordinary problem-solving capabilities. With 49 lines of program memory, the HP-33C's easy-to-master programming capability helps you perform complicated technical calculations quickly and accurately. And the Continuous Memory feature allows you to retain programs and data even when the calculator is turned off. This not only saves you time, but helps to conserve battery life.

To increase calculator versatility, HP offers these application books: Mathematics, Statistics, Student Engineering, and Surveying. They provide easy-to-understand, step-by-step procedures designed to get you through even the toughest problems.

The HP-33C comes complete with an Owner's Handbook, the informative "Solving Problems with Your Hewlett-Packard Calculator", recharger/AC adapter, rechargeable battery pack, quick reference card, Standard Applications Book, and soft carrying case.

HP-33C Specifications

Mathematical Functions: SIN, COS, TAN, and inverses, DEG, RAD, GRAD, R \rightleftharpoons P, DEG \rightleftharpoons RAD, H \rightleftharpoons H.MS, log, 10^x , LN, e^x , y^x , \sqrt{x} , x^2 , $1/x$, π , +, -, \times , \div , ABS, integer/fraction truncation.

Statistical Functions: \bar{x} , s, r, L.R., \hat{x} , \hat{y} , summations (n , Σx , Σx^2 , Σy , Σy^2 , Σxy).

Programming Features: SST, BST, GTO, GSB, RTN, R/S, pause, no-operation, 3 levels of subroutines, 8 conditional tests ($x=0$, $x\neq 0$, $x<0$, $x>0$, $x\leq y$, $x>y$, $x=y$, $x\neq y$).

Clearing Options: CLEAR X, STACK, REGISTERS, PROGRAM, PREFIX.

Memory: 8 storage registers, last-x register, 49 program lines.

Recharger Power Requirements: 90 to 120 Vac or 198 to 242 Vac (50 to 60 Hz).

Size: 30 \times 75 \times 140 mm (1.2 \times 3.0 \times 5.6 in).

COMPUTERS, PERIPHERALS & CALCULATORS

Personal Computation

Models HP-34C, HP-67, HP-97

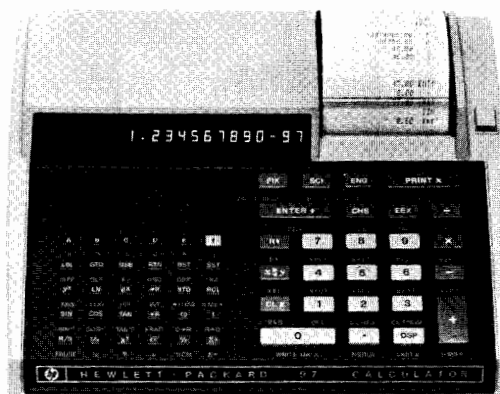
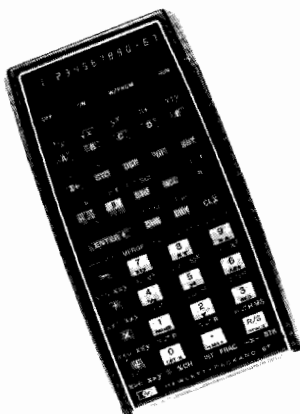
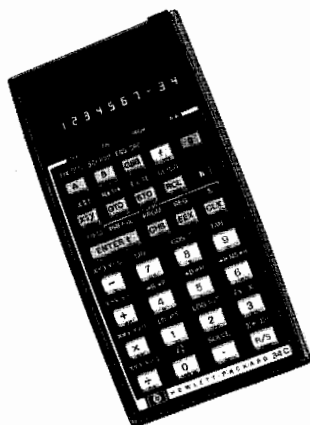

HP-34C Advanced Programmable Scientific with Continuous Memory

The HP-34C is designed for science students and professionals who need the flexibility and power of advanced programming, as well as a full set of preprogrammed scientific functions. Included are two unique keyboard functions "solve," which finds real roots for a wide range of functions, and "integrate," which computes that area of a function bounded by upper and lower limits. Additionally, the HP-34C has Continuous Memory, which lets you retain programs and data even when the calculator is turned off.

The advanced programming features of the HP-34C include 12 addressable labels, insert/delete editing, and a dynamically controlled memory that varies between 210 program lines and 21 user storage registers. To increase calculator versatility, you can write your own programs, or use application books HP has developed.

The HP-34C comes complete with an Owner's Handbook, the informative "Solving Problems with Your Hewlett-Packard Calculator", recharger/AC adapter, rechargeable battery pack, quick reference card, Standard Applications Book, and soft carrying case.

HP-34C Specifications

Mathematical Functions: SIN, COS, TAN, and inverses, DEG, RAD, GRAD, $R \rightleftharpoons P$, $DEG \rightleftharpoons RAD$, $H \rightleftharpoons H.MS$, log, 10^x , LN, e^x , y^x , \sqrt{x} , x^2 , $1/x$, π , +, -, \times , \div , ABS, integer/fraction truncation.

Statistical Functions: %, $\Delta\%$, \bar{x} , s, r, L.R., \bar{y} , summations (n , Σx , Σx^2 , Σy , Σy^2 , Σxy), factorial, Gamma functions.

Programming Features: label addressing, 2 user-definable keys and 12 labels; indirect addressing of labels, data storage, and program lines; 6 levels of subroutines, controlled looping, 4 flags, 8 conditional tests ($x=0$, $x \neq 0$, $x < 0$, $x > 0$, $x=y$, $x \neq y$, $x > y$, $x \leq y$), editing operations include singlestep execution, single- and backstep inspection of a program, insert/delete editing, positioning the calculator at any step in program memory, and pause.

Clearing Options: CLEAR X, REGISTERS, STATISTICAL, PROGRAM, PREFIX.

Display: fixed decimal, scientific, and engineering notation, display mantissa, commas separate thousands.

Memory: 4-register stack, last-x register, continuous dynamic memory allocation from 70 program lines and 20 storage registers to 10 program lines and 1 storage register (the indirect register).

Recharger Power Requirements: 90 to 120 Vac or 198 to 242 Vac (50 to 60 Hz).

Size: 30 x 75 x 140 mm (1.2 x 3.0 x 5.6 in).

Ordering Information

HP-11C	\$135.00
HP-32E	\$55.00
HP-33C	\$90.00
HP-34C	\$150.00
HP-11C Solutions Handbook	\$20.00
HP-33C Optional Application Books	\$5.00
HP-34C Optional Application Books	\$8.00

HP-67 Handheld Fully Programmable and HP-97 Desktop Fully Programmable Printing

The HP-67 offers exceptional power to handle your lengthy and repetitive problems. For those who prefer a desktop version, the HP-97 has all the capabilities of the HP-67 plus the convenience of a built-in printer—all battery-operable.

Keystroke programming with the HP-67/97 is push-button easy. An editing feature in both calculators enables you to easily correct and modify your programs. All commonly used mathematical, trigonometric and statistical functions are included. The HP-67/97 has 224 program lines, plus 26 storage registers.

These calculators come complete with an Owner's Handbook, quick reference card (HP-67 only), Standard Pac complete with 40 magnetic cards, card holder, and manual, rechargeable battery pack, recharger/AC adapter, programming pad, soft carrying case, and 2 rolls of thermal paper (HP-97 only).

HP-67/97 Specifications

Mathematical Functions: SIN, COS, TAN, and inverses, DEG, RAD, GRAD, $R \rightleftharpoons P$, $DEG \rightleftharpoons RAD$, $H \rightleftharpoons H.MS$, integer/fraction truncation, ABS, round, log, 10^x , LN, e^x , y^x , \sqrt{x} , x^2 , $1/x$, π , +, -, \times , \div .

Statistical Functions: %, $\Delta\%$, \bar{x} , s, summations (n , Σx , Σx^2 , Σy , Σy^2 , Σxy), factorials.

Programming Features: direct line branching, label addressing, 10 user-definable keys and 20 labels; indirect addressing of labels and data storage; 3 levels of subroutines, controlled looping, 4 flags, 8 conditional tests. Singlestep execution, single- and backstep inspection of a program, insert/delete editing, position the calculator at any step in program memory, pause to review intermediate results, key in data, or load magnetic cards.

Card Reader: record/load all data registers; load selected data registers; record/load entire program memory; merge program subsections; angular mode, flag settings, and display status are recorded with program recording and reset with program loading; user is prompted for proper operation when loading; card reader operations can be initiated manually or under program control (except program recording).

Clearing Options: CLEAR X, REGISTERS, PROGRAM.

Display: fixed decimal, scientific, and engineering notation.

Memory: 224 program lines, 26 data storage registers, 4-register stack, last-x register.

HP-67 Power Requirements: 86 to 127 Vac or 172 to 254 Vac, (50 to 60 Hz), or 3.75 Vdc nickel cadmium rechargeable battery pack.

HP-97 Power Requirements: 90 to 127 Vac or 200 to 254 Vac, (50 to 60 Hz), or 5.0 Vdc nickel cadmium rechargeable battery pack.

HP-67 Size: 18 to 34 x 81 x 152 mm (0.7 to 1.4 x 3.2 x 6 in).

HP-97 Size: 64 x 229 x 203 mm (2.5 x 9 x 8 in).

Ordering Information

HP-67	\$375.00
HP-97	\$750.00
HP-67/97 Application Pacs	\$35.00

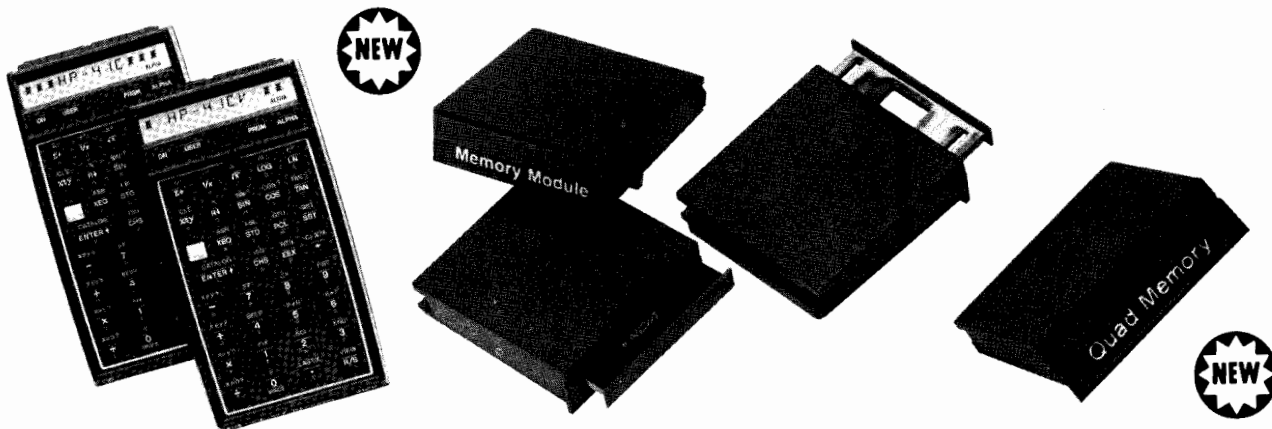

HP-41C or HP-41CV Alphanumeric Full Performance Programmable with Continuous Memory

The HP-41 is the most powerful handheld, programmable calculator ever made by HP. You now have two calculators to choose from: the HP-41C with 441 bytes of program memory built in (expandable to 2,233 bytes) or the HP-41CV with 2,233 bytes built in.

The HP-41 communicates with words as well as numbers. You can key in any combination of letters and numbers up to 24 characters wide and display 12 characters at a time. A complete system of status annunciators also helps to keep you firmly in control. Error messages are displayed in plain, understandable English. For aural feedback, you can use the HP-41 "beeper." Ten different tones will let you signal the end of a program or data entry point. Continuous Memory saves your programs and data even when the calculator is turned off. Over 130 separate operations comprise the total HP-41 function catalog. You can assign a function or program to almost any key. The HP-41 comes with keyboard overlays and a set of user labels to help facilitate customization of your HP-41. With a few keystrokes, you can actually create a "personalized" custom calculator for special applications.

You can store more and longer programs in the HP-41 than you ever thought possible. Each program is autonomous. Call it up by name, edit it, even clear it without affecting other programs. And each program can have up to 99 local plus 15 local alpha labels for addresses or subroutines. However, these independent programs can also be interactive. Using global labels, you can summon one program or branch to a subroutine (up to 6 levels) from another program.

Both the HP-41C and HP-41CV come complete with Owner's Handbook and Programming Guide, quick reference guide, application book, 4 N-cell batteries, 2 keyboard overlays, 1 module or overlay holder, 1 set of function labels, and a soft carrying case.

HP-41C and HP-41CV Specifications

Mathematical Functions: SIN, COS, TAN, and inverses, DEG, RAD, GRAD, $R \rightleftharpoons P$, $DEG \rightleftharpoons RAD$, $H \rightleftharpoons H.MS$, octal/decimal conversions, sign, modulo, INT, FRAC, ABS, round, log, 10^x , e^x , $\ln(1+x)$, $e^x - 1$, y^x , \sqrt{x} , $1/x$, π , $+$, $-$, \times , \div , LN, H.MS \pm , CHS.

Statistical Functions: $\%$, $\Delta\%$, \bar{x} , s, summations (n , Σx , Σx^2 , Σy , Σy^2 , Σxy), summation corrections, select summation registers, factorials.

Stack Functions: ENTER \uparrow , $R\downarrow$, $R\downarrow$, $x \rightleftharpoons y$, $X \rightleftharpoons REGISTER$, LAST-X.

Alpha Symbols: upper-case alpha A through Z, lower-case alpha a through e, Σ , $\%$, \neq , $<$, $>$, \dagger , \leftarrow , $\$$, $+$, $-$, $/$, $*$, $:$, $::$, $?$, $=$, space.

User-Definition: alpha mode on and off, alpha store and recall, alpha shift left, alpha view, append alpha.

Programming Features: 100 numeric labels, unlimited global alpha labels, user-definable keys, indirect addressing of labels, data storage and recall, storage register arithmetic, alpha storage and recall, viewing register contents, display formats, looping, audible tone pitch, definition of accumulation registers, flag setting and clearing, catalog

list, 6 levels of subroutines, controlled looping, 30 user flags, 26 system flags, 4 flag test functions in addition to set flag and clear flag, 10 conditional tests, 2 of which may be used with alpha strings ($x=y$, $x \neq y$).

Editing: singlestep execution, single- and backstep inspection of a program, delete program memory lines, position the calculator at any line in program memory, pause to review intermediate results, correction key to delete keystroke while entering data or alpha character, change size of data storage register allocation, catalog positioning.

General: label program, alpha prompt, aural prompt, pack program memory, stop, end, programmable OFF, go to end of program memory and prepare calculator for new program, advance paper, prompt, catalog list, copy program from ROM to user memory.

Clearing Options: DISPLAY, X REGISTER DATA, REGISTERS, ALPHA, PROGRAM, FLAG, STACK, STATISTICS REGISTERS.

Display: fixed decimal, scientific, and engineering notation.

Memory: last-x register, 4-register stack, alpha register, data storage registers.

HP-41C: 63 registers and 0 program bytes or 0 registers and 441 bytes (expandable to 2,233 bytes).

HP-41CV: 319 registers and 0 program bytes, or 0 registers and 2,233 bytes.

Power Requirements: 4 size N batteries, not rechargeable. Optional nickel cadmium battery pack.

Size: 33 x 79 x 144 mm (1.3 x 3.1 x 5.7 in).

Alone, the HP-41 is a powerful, programmable, problem-solving calculator. But, by adding optional plug-in peripherals and modules, you can expand the capabilities of the HP-41 to keep pace with your growing computational needs. Four input/output (I/O) ports at the top of the HP-41 accept peripherals, plug-in application modules, or Memory Modules. Each quick-connect peripheral and module is self-contained, with its own set of functions that is added to the calculator's existing function catalog. And each peripheral and module is fully portable.

HP 82106A Memory Module

These Memory Modules can quintuple the HP-41C's memory. Each module contains an additional 64 registers that can be allocated as program memory or storage registers, or any combination. You can add four Memory Modules to your HP-41C for a total of 319 storage registers or 2,233 bytes. The Memory Modules, like the HP-41C have Continuous Memory. However, memory loss will occur when the module is removed from the calculator. (Use only with the HP-41C.)

HP 82170A Quad Memory Module

The equivalent of four Memory Modules, the Quad Memory Module contains 256 data storage registers or 1,792 program bytes and expands the HP-41C's memory to full HP-41CV capacity using only one port. The Quad Memory Module, like the HP-41C, has Continuous Memory. However, memory loss will occur when the module is removed from the calculator. (Use only with the HP-41C.)

COMPUTERS, PERIPHERALS & CALCULATORS

HP-41 Peripherals, Software, Accessories



HP 82104A Card Reader

Reads and writes programs and data onto magnetic cards with 32 registers per card. Adds over 30 card reader control functions to your calculator, including prompts and program security. Also reads HP-67/97 program cards.

HP 82143A Thermal Printer/Plotter

Portable, quiet, thermal operation, and battery operable, the HP 82143A prints upper- and lower-case alpha characters, including special characters you can create. The Printer/Plotter also does high-resolution plotting routines.

HP 82153A Optical Wand

Inputs data by reading programs in the form of bar code. Most HP-41 software is available in bar code, including Users' Library programs and solutions books.

HP-41 Application Pacs

Whether you're an engineer or technician, student or scientist, business person or other professional, you'll find an application pac or solutions book to solve many of the most common and difficult problems in your area.

Every application pac comes with a comprehensive manual, and, when applicable, a keyboard overlay. Choose from:

- | | |
|-----------------------------------|--|
| • Aviation | • Petroleum Fluids |
| • Clinical Lab & Nuclear Medicine | • Securities |
| • Circuit Analysis | • Statistics |
| • Financial Decisions | • Stress Analysis—Mechanical Engineers |
| • Mathematics | • Structural Analysis—Civil Engineers |
| • Games | • Surveying |
| • Home Management | • Machine Design |
| • Real Estate | • Navigation |
| • Thermal & Transport Science | |

HP-41 Solutions Books

Business:

- | | |
|---------------------------------------|-------------------------------|
| • Business Statistics/Marketing/Sales | • Lending, Savings, & Leasing |
| • Home Construction Estimating | • Real Estate |
| | • Small Business |

Engineering:

- Antennas
- Chemical Engineering
- Civil Engineering
- Control Systems
- Electrical Engineering
- Fluid Dynamics & Hydraulics
- Heating, Ventilating, & Air Conditioning
- Mechanical Engineering
- Solar Engineering

Computation:

- Geometry
- High-Level Math
- Test Statistics

Other:

- Calendars
- Cardiac/Pulmonary
- Chemistry
- Games
- Optometry I (General)
- Optometry II (Contact Lenses)
- Physics
- Surveying
- Taxes

Ordering Information

	Price
HP-41C	\$250.00
HP-41CV	\$325.00
HP 82106A Memory Module	\$30.00
HP 82170A Quad Memory Module	\$95.00
HP 82104A Card Reader	\$215.00
HP 82143A Thermal Printer/Plotter	\$385.00
HP 82153A Optical Wand	\$125.00
HP-41 Application Pacs	\$30.00 to \$75.00
HP-41 Solutions Books	\$12.50

Calculator Accessories

A Hewlett-Packard calculator purchase is a smart decision. Power, convenience, and quality from a company you can depend on. But HP calculators also have a versatility unequaled in the industry. There's a complete accessory line engineered to provide the support you need. No matter what type of Hewlett-Packard calculator you choose, you'll find it supported by a full line of replacement accessories and supplies to keep it operational.

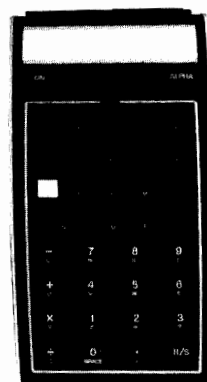
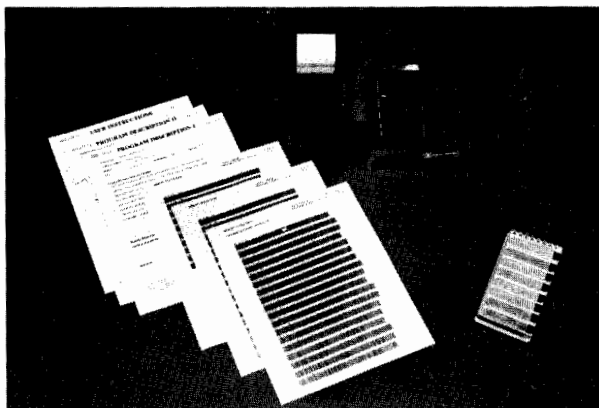

HP Users' Library

The Users' Library is dedicated to making programs contributed by HP-67, HP-97 and HP-41 users available to others. You'll discover a wide variety of programs written for specific applications areas. The solutions you need may already exist! As a subscriber to the Library, you will receive the *Catalog of Contributed Programs* and the *Contributor's Guide*, periodic supplements, and coupons for four programs of your choice complete with pre-recorded magnetic cards. You will also receive the *HP Key Notes* newsletter, which keeps you abreast of programming techniques, Library activities, and notes of interest.

Ordering Information

First Year Subscription	\$20.00
Annual Renewal	\$10.00
HP-67, HP-97 Programs (Includes program descriptions/listings, and magnetic cards.)	\$6.00
HP-41C, HP-41CV Programs (Includes program descriptions/listings, magnetic cards, and bar code.)	\$6.00

Custom Services

HP Custom Services satisfies the growing need for specialization in portable computing products. Through customization, the powerful HP-41C and HP-41CV calculators can be tailored to do your dedicated complex or repetitious calculations when and where you need them.

Using customer or third party written programs, the HP-41 or an HP-41 with blank keys (Option 001), can be customized using one of three options: custom ROM's, custom magnetic cards or custom bar code. Each option is designed to suit particular information and problem-solving requirements. When selecting one of these alternatives, consideration is given to: frequency of code alterations, desired program capacity, updating of variables in your data, required level of privacy and initial investment. For assistance, consult your local HP Field Engineer.

HP 82500A or B Custom Modules (ROM's)

4K or 8K bytes of memory with each module. Nearly 21,000 program lines with up to four 8K modules.

HP 82502A Custom Magnetic Cards

Used with the HP-41C, HP-41CV, HP-67, and HP-97. Each card can be customized to load 175 to 200 instructions.

Custom Bar Code

Inexpensive way to load custom programs or data. Available from an independent vendor.

The HP-41 saves time, lowers cost, and ensures accuracy for both the technical and non-technical user. The standard HP-41 allows you to retain access to the full programmable capabilities and scientific functions of the calculator even after it has been customized.

A custom HP-41C or HP-41CV Option 001 with a blank keyboard, is made as friendly as possible. This special calculator limits use to those keys you have designated, minimizing potential user error. Custom overlays, (HP 82501A), label keys for either calculator and provide the final, professional touch.

Already many companies have improved their productivity with customized HP-41's. Proven applications, from banking to fuel savings, from media buying to heavy equipment sales and service, from circuit design to diamond sales, give the same result, increased performance and improved productivity.

Ordering Information

Quantity	Custom Modules		Custom Mag Card 4K (18 cards/set)	Custom Bar Code 4K (6 cards/prog) (3 prog)
	8K	4K		
100	NA	NA	\$99/set	\$3.51/set
250	\$102	\$ 63	\$46/set	\$3.02/set
500	\$ 62	\$ 39	\$28/set	\$2.86/set
1000	\$ 42	\$ 27	\$19/set	\$2.78/set
5000	\$ 26	\$ 17	\$12/set	\$2.72/set



COMPUTERS, PERIPHERALS & CALCULATORS

Personal Computation

Comparison Chart

	Programmable									
	Financial			Advanced			Scientific			
	HP-37E	HP-12C	HP-38C	HP-67/97	HP-41C/CV	HP-34C	HP-11C	HP-33C	HP-32E	
Operating Features										
RPN logic system	•	•	•	•	•	•	•	•	•	•
Automatic 4-register stack	•	•	•	•	•	•	•	•	•	•
Error recovery (last x)	—	—	—	•	•	•	•	•	•	•
Stack manipulation	•	•	•	•	•	•	•	•	•	•
Maximum number of storage registers	7	20	20	26	319°	21	21	8	15	
Continuous Memory	—	•	•	—	•	•	•	•	—	
Maximum number of digits displayed	10	10	10	10	10	10	10	10	10	
Number of digits used in computation	10	10	10	10	10	10	10	10	10	
Rechargeable batteries/AC recharger	•	—	•	•	—	•	—	•	•	
Long-life disposable batteries	—	•	—	—	•	—	•	—	—	
Software Support										
Application Pacs (with modules)	—	—	—	—	•	—	—	—	—	
Application Pacs (with mag cards)	—	—	—	•	—	—	—	—	—	
Solutions Books	—	—	—	•	•	—	—	•	—	
Solutions Handbooks	—	—	—	—	•	—	—	•	—	
Users' Library programs	—	—	—	•	•	—	—	—	—	
Application Books	•	—	•	—	—	•	—	•	•	
Accessory Support										
Memory Modules	—	—	—	—	•+	—	—	—	—	
Reserve Power Pack	•	—	•	•	—	•	—	•	•	
Security cradle/cable	—	—	—	•	—	—	—	—	—	
Multipurpose rechargeable battery pack	—	—	—	—	•	—	—	—	—	
One-year limited warranty	•	•	•	•	•	•	•	•	•	
Display separates thousands	•	•	•	—	•	•	•	•	•	
Diagnostic self-check	•	•	•	S	—	•	•	•	•	
Error codes/messages	•	•	•	—	•	•	•	•	•	
Redefinable keyboard	—	—	—	—	•	—	—	—	—	
Alpha mode/display	—	—	—	—	•	—	—	—	—	
Alpha prompts	—	—	—	—	•	—	—	—	—	
Status annunciators	—	•	—	—	•	—	—	—	—	
Automatic power off	—	•	—	—	•	—	•	—	—	
Catalog of functions, programs and peripheral functions	—	—	—	—	•	—	—	—	—	
Audible tones	—	—	—	—	•	—	—	—	—	
Programming Features										
Maximum number of program lines	—	99	99	244	2,233°	210	203	49	—	
Shared program/storage memory	—	•	•	—	•	•	•	—	—	
Alpha program labels	—	—	—	—	•	—	—	—	—	
Single character program labels	—	—	—	10	56	2	5	—	—	
Numeric program labels	—	—	—	10	99	10	10	—	—	
Program review: (single- and back-step)	—	•	•	•	•	•	•	•	—	
Insert/delete editing	—	—	—	•	•	•	•	—	—	
Unconditional branching	—	•	•	•	•	•	•	•	—	
Levels of subroutines	—	—	—	3	6	6	4	3	—	
Conditional tests	—	2	2	8	10	8	8	8	—	
Flags	—	—	—	4	56	4	2	—	—	
Pause	—	•	•	•	•	•	•	•	—	
Looping (DSZ, ISZ)	—	—	—	•	—	—	—	—	—	
Indexed looping (DSE, ISG)	—	—	—	—	•	—	—	•	—	
Indirect control of:										
Data storage and recall	—	—	—	•	•	•	•	—	—	
Alpha storage and recall	—	—	—	—	•	—	—	—	—	
Storage register arithmetic	—	—	—	•	•	•	•	—	—	
Branching and looping	—	—	—	•	•	•	•	—	—	
Display format	—	—	—	•	•	•	•	—	—	
Flags	—	—	—	—	•	—	—	—	—	
Integer/fraction truncation	—	•	•	•	•	•	•	•	—	
Alpha string manipulation	—	—	—	—	•	—	—	—	—	
Input/Output Devices										
Card reader	—	—	—	•	P	—	—	—	—	
Battery-operable Printer/Plotter	—	—	—	97	P	—	—	—	—	

Symbols

• Built-in feature or function.

— Not available.

° The HP-41C has 441 program bytes built in (expandable to 2,233 bytes). The HP-41CV has 2,233 program bytes built in.

+ To be used with the HP-41C only.

S Available in software form

P Peripheral available

	Programmable										
	Financial			Advanced			Scientific				
	HP-37E	HP-12C	HP-38C	HP-67/97	HP-41C/CV	HP-34C	HP-11C	HP-33C	HP-32E		
Optical Wand (bar code reader)	—	—	—	—	—	—	P	—	—	—	—
General Features											
+ , - , X , + , y ^x , √ x , 1/x , CHS	•	•	•	•	•	•	•	•	•	•	•
Ln x , e ^x	•	•	•	•	•	•	•	•	•	•	•
Log x , 10 ^x	•	•	•	•	•	•	•	•	•	•	•
x ²	—	—	—	•	•	•	•	•	•	•	•
π	—	—	—	•	•	•	•	•	•	•	•
Absolute value	—	—	—	•	•	•	•	•	•	•	•
Storage register arithmetic	•	•	•	•	•	•	•	•	•	•	•
Business Features											
Maximum number of dedicated financial registers	5	5	5	—	—	—	—	—	—	—	—
Solves for:											
Number of periods (n), compound interest (i), present value (PV), payment (PMT), future value (FV)	•	•	•	S	S	S	S	S	S	—	—
Simple interest	—	•	•	S	S	—	—	—	—	—	—
Accumulated interest/remaining balance (amortization)	•	•	•	S	S	S	S	S	S	—	—
Net present value (NPV) and internal rate of return (IRR)	—	•	•	S	S	S	—	—	—	—	—
Price	•	—	—	—	—	—	—	—	—	—	—
Beginning/end of period selection	•	•	•	S	S	S	S	—	—	—	—
Calendar functions	—	•	•	S	S	—	—	—	—	—	—
Bond:											
Yield-to-maturity	—	•	—	S	S	—	—	—	—	—	—
Price	S	•	S	S	S	—	—	—	—	—	—
Depreciation (SL, DB, SOYD)	S	•	S	S	S	—	S	—	—	—	—
Scientific Features											
Solve (root finder)	—	—	—	S	S	•	S	S	—	—	—
Integrate (numerical integration)	—	—	—	S	S	•	S	S	—	—	—
Metric conversions	—	—	—	S	S	—	—	—	—	•	—
Trigonometric functions:											
Modes (degrees, radians, grads)	—	—	—	•	•	•	•	•	•	•	•
Sin, Sin ⁻¹ , Cos, Cos ⁻¹ , Tan, Tan ⁻¹	—	—	—	•	•	•	•	•	•	•	•
Hyperbolics and inverses	—	—	—	S	S	S	•	S	•	•	•
Rectangular ↔ polar coordinates	—	—	—	•	•	•	•	•	•	•	•
Decimal angle ↔ angle in degrees (hrs)/min/sec	—	—	—	•	•	•	•	•	•	•	•
Degrees → radians	—	—	—	•	•	•	•	•	•	•	•
Fixed and scientific notation	•	•	•	•	•	•	•	•	•	•	•
Engineering notation	—	—	—	•	•	•	•	•	•	•	•
Automatic over/under flow into scientific	•	•	•	•	•	•	•	•	•	•	•
Decimal/octal conversion	—	—	—	—	•	—	—	—	—	—	—
Statistical Functions											
Percent	•	•	•	•	•	•	•	•	•	•	•
Percent change	•	•	•	•	•	•	•	•	•	•	•
Percent total	•	•	•	—	—	—	—	—	—	•	•
Mean/standard deviation (1- or 2- variable)	•	•	•	•	•	•	•	•	•	•	•
(n, Σx, Σx ² , Σy, Σy ² , Σxy)	•	•	•	•	•	•	•	•	•	•	•
Linear regression/estimate	•	•	•	S	S	•	•	•	•	•	•
Correlation coefficient	•	•	•	S	S	•	•	•	•	•	•
Normal distribution	—	S	S	S	S	S	S	S	S	•	•
Factorial function	•	•	•	•	•	•	•	•	•	•	•
Gamma function	—	—	—	S	S	•	•	—	—	—	—
Permutations and combinations	—	S	S	S	—	S	•	S	•	—	—
Random number generator	—	S	S	S	—	—	•	S	—	—	—

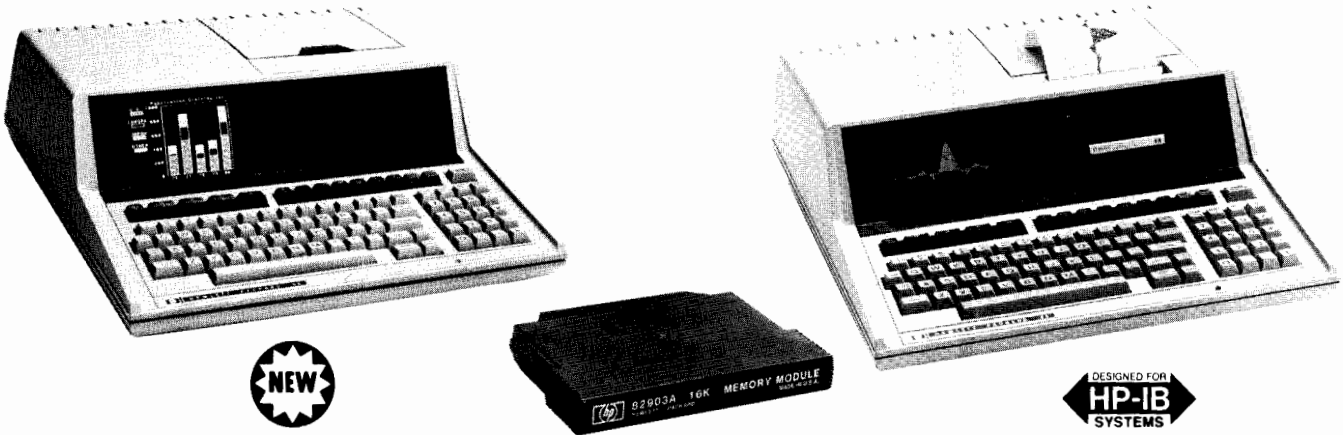

Why a Personal Computer?

As a working professional, you need dedicated problem-solving power. HP's Series 80 Personal Computers give it to you. Choose from two powerful mainframes, the HP-83 or the integrated HP-85 with built-in thermal printer and tape cartridge drive. With Series 80 you can easily expand memory or add an exciting array of powerful peripherals to enhance your computing system. But Series 80 is much more than computer hardware. Series 80 includes a wide range of innovative software solutions. From the worksheet wizardry of VisiCalc™ PLUS to the professional-looking graphics of the Graphics Presentations Pac, Hewlett-Packard is committed to providing you with software tools that satisfy your computational requirements and communicate your data in a meaningful manner.

VisiCalc™ is a trademark of Personal Software Inc.

Series 80 Mainframes

The HP-83 and HP-85 are powerful BASIC language, personal computers with integrated graphics systems. Four ports allow you to expand the memory, add enhancement modules, and attach peripherals. Application pacs on tape cartridges or flexible discs let you customize the system to fit your needs.

A Series 80 Personal Computer gives you enhanced HP BASIC (a super-set of ANSI BASIC) with more than 150 commands and statements for problem solving. BASIC is easy to learn through HP's friendly manuals and the HP BASIC Training Pac. And both computers are friendly and forgiving—if you make a mistake, you're able to recover quickly and easily.

Enhancement ROM's (read-only memories) extend the capabilities of both Series 80 Computers. They add commands and predefined functions to the mainframes, increase the capabilities of existing commands, or allow you to interface the computers with peripherals. Memory is expandable up to 112K bytes. It includes a 32K ROM operating system, a 16K internal read/write memory that doubles to 32K RAM with a plug-in Memory Module, and the capacity for six 8K ROM's. And because the 32K ROM operating system is built into the computer, you don't have to worry about loading it. All the read/write memory (except 1.5K bytes used for buffers) remains available to you.

In addition to the operating system, other built-in features include a typewriter-like alphanumeric keyboard, editing keys, debugging tools, and a 20-key numeric keypad.

Additional Features and Benefits of the HP-85

The HP-85 is an integrated, compact, portable computing system. The HP-85's quiet, bidirectional printer produces quality alphanumeric and graphics. It has adjustable intensity, and prints two 32-character lines per second.

The HP-85 has a built-in tape drive too. Each magnetic tape cartridge provides high-density digital storage for 210K bytes of data or 195K bytes of programs. When traveling with the HP-85, you can take along both data and software on tape cartridges.

HP-83/HP-85 Specifications

Memory: 16K bytes (10% overhead), expandable to 32K bytes with the addition of the plug-in HP 82903A 16K Memory Module.

CRT: 5-inch diagonal with adjustable intensity, 256 x 192 dot resolution.

Thermal printer (HP-85 only): 32-character width, 2 lines per second, bidirectional printer, adjustable intensity.

Magnetic tape cartridge (HP-85 only): 210K bytes capacity, 42 separate files, search speed of 60"/s, read/write speed of 10 IPS.

Power requirements: 90 to 127 Vac (115 Vac line), 200 to 254 Vac (230 Vac line), switchable at rear panel. Frequency of 50 to 60 Hz.

Size: 15.0 x 41.9 x 45.2 cm (6.25 x 16.5 x 17.8 in).

System Expansion Capability

Both the HP-83 and the HP-85 are designed as expansion-oriented systems. The application of enhancement ROM's and interfaces provides advanced I/O capability usually found only in larger systems. HP-IB and RS-232 Interfaces allow Series 80 computers to connect to many powerful peripherals.

HP 82900-Series and HP 9895A Flexible Disc Memory: these disc drives use double-sided, double-density, HP-qualified flexible discs. Connect the disc drives to your Series 80 Personal Computer with the HP-IB Interface Module (HP 82937A) and the Mass Storage ROM (00085-15001) to add 30 operations for complete control and utilization of the disc drives or other mass storage devices.

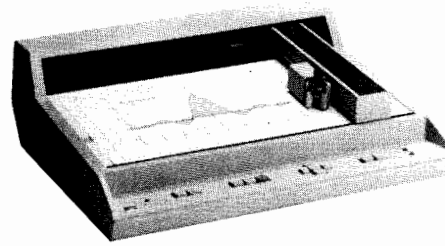
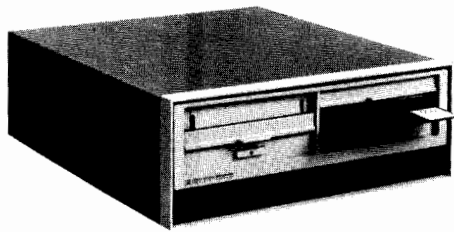
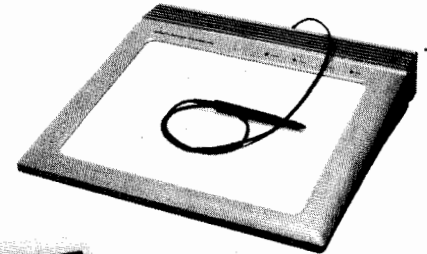
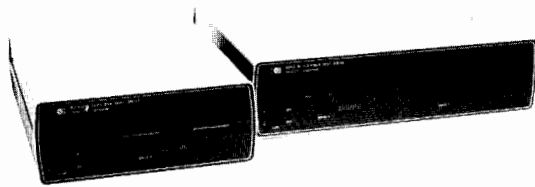

HP 82901M Flexible Disc Drive: supplies approximately 540K bytes of on-line storage. This unit consists of one master controller with two drives.

HP 82902M Flexible Disc Drive: supplies approximately 270K bytes of on-line storage. This unit consists of one master controller and one drive.

HP 9895A Flexible Disc Drive: supplies up to 2,360K bytes of mass storage capacity on two 8-inch discs. This unit consists of one master controller and two disc drives.

HP 9895A Flexible Disc Drive Option 010: supplies 1,180K bytes of on-line storage. This unit consists of one master controller and one disc drive.

HP 9895A Flexible Disc Drive Option 011: supplies, as an add-on unit, an additional 1,180K bytes when connected to one of the two master drives.

HP 9895A Flexible Disc Drive Option 012: supplies, as an add-on unit, an additional 2,360K bytes when connected to one of the two master drives.

HP 7225B Graphics Plotter

Produces high-quality plots on any size chart up to 210 x 297 mm (8.3 x 11.7 in). The Plotter has exceptional line quality with addressable moves as small as 0.32 mm (0.0013 in). An HP 17601A Option 085 Personality Module, which plugs into the HP 7225B, is required for interfacing with a Series 80 computer. The Plotter/Printer ROM (00085-15002) completes the interfacing package.

HP 9111A Graphics Tablet

The Graphics Tablet lets you interact with the graphics display on your Series 80 computer, and, if desired, with the HP 7225B Graphics Plotter. As you move a pen-like stylus around the tablet, the tablet translates your movements into digital code and transmits this code to the computer. Utility software programs interpret these points in ways specific to each program's application. Requirements for interfacing with a Series 80 Personal Computer include the HP 82903A 16K Memory Module, HP 82937A HP-IB Interface, and Plotter/Printer ROM (00085-15002).

HP 82905A Printer

The HP 82905A Printer operates bidirectionally at 80 characters/s. In text mode, a logic-seeking feature finds the shortest lines, permitting optional printing throughput. The 9 x 9 dot matrix provides a character set with true descending characters. Compressed and expanded modes provide print at 5, 8.25, 10, and 16.5 characters/in., allowing up to 132 characters per line on an 8½-inch page. A special graphics mode allows dot-by-dot control of the printing to provide either 72 x 60 or 72 x 120 dots per inch. Programmable line spacing allows the printing of subscripts and superscripts, and specialized forms. Requirements for interfacing with a Series 80 computer include the HP 82903A 16K Memory Module, HP 82937A HP-IB Interface, and Plotter/Printer ROM (00085-15002).

HP 2631B Impact Printer

A full-size, high-speed, bidirectional, dot-matrix impact printer for high-volume applications. It prints 180 characters per second on inexpensive computer paper or multipart forms. This printer has eight print sizes and a forms tractor. The Plotter/Printer ROM (00085-15002) and the HP 82937A HP-IB Interface integrate the printer into the system.

HP 2671A Printer

The 2671A features the full 128 USASCII character set, Roman extension characters for international use, and line drawing characters to create forms. Print modes include normal at 10 CPI and compressed at 16.2 CPI for a maximum of 132 characters per line. Additional features of the 2671A include 120 character per second speed, bidirectional thermal printing, a 9 x 15 dot matrix character cell and true descending characters. Requirements for interfacing with a Series 80 computer include the HP 82937A HP-IB Interface and the Plotter/Printer ROM (00085-15002).

HP 2671G Graphics Printer

The 2671G offers all the features of the 2671A plus high-resolution graphics printing of charts, tables, illustrations and graphs. Additional features include bidirectional thermal printing, 120 CPS, 9 x 15 dot matrix character cell and true descenders. Requirements for interfacing with a Series 80 computer include the HP 82937A HP-IB Interface and the Plotter/Printer ROM (00085-15002).

COMPUTERS, PERIPHERALS & CALCULATORS

Personal Computation

Series 80 Peripherals

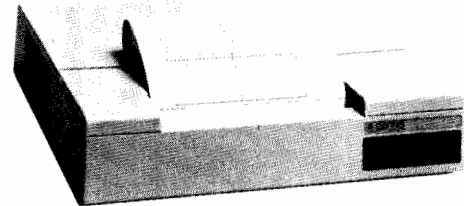
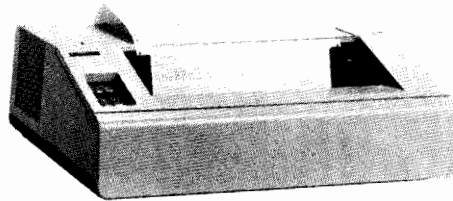
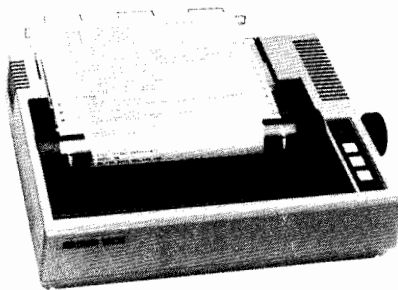

HP 2673A Intelligent Graphics Printer

The 2673A includes all the capabilities of the 2671A/G plus auto-centering, windowing, and offsets. Margins, tabs, print mode, character sets, page format, and data communications parameters are selected via an expanded control panel. The 2673A offers bidirectional thermal printing at 120 CPS, with 9 x 15 dot matrix character cells and true descenders. Requirements for interfacing with a Series 80 computer include the HP 82937A HP-IB Interface and the Plotter/Printer ROM (00085-15002).

Ordering Information

	Price
HP-83A Personal Computer	\$2250.00
HP-85A Personal Computer	\$3250.00
HP 82903A 16K Memory Module	\$295.00
HP 82901M Flexible Disc Drive	\$2500.00
HP 82902M Flexible Disc Drive	\$1500.00
HP 9895A 8-inch Master Flexible Disc Drive	\$6830.00
HP 9895A Option 010 8-inch Master Flexible Disc Drive	\$4990.00
HP 9895A Option 011 8-inch Single Add-on Flexible Disc Drive	\$3940.00
HP 9895A Option 012 8-inch Dual Add-on Flexible Disc Drive	\$5780.00
HP 7225B Graphics Plotter with HP 17601A Option 085 Personality Module	\$2950.00
HP 9111A Graphics Tablet	\$2050.00
HP 82905A Option 001 Printer (Voltage 100V)	\$995.00
HP 82905A Option 002 Printer (Voltage 120V)	\$945.00
HP 82905A Option 003 Printer (Voltage 220V)	\$995.00
HP 82905A Option 004 Printer (Voltage 250V)	\$995.00
HP 2631B Option 885 Impact Printer	\$3950.00
HP 2671A Printer	\$1095.00
HP 2671G Graphics Printer	\$1295.00
HP 2673A Intelligent Graphics Printer	\$1895.00

Series 80 Enhancements

HP 82936A ROM Drawer: plugs into a Series 80 Personal Computer port. The Drawer has slots for six 8K ROM's.

Mass Storage ROM (00085-15001): adds 30 operations that enable complete control and utilization of HP 82900-Series and HP 9895A Flexible Disc Memory.

Plotter/Printer ROM (00085-15002): enables you to interface your Series 80 computer with Hewlett-Packard's high-resolution graphics plotters and full-width printers.

I/O ROM (00085-15003): provides BASIC language extensions for general I/O capability for a variety of interfaces and devices.

Matrix ROM (00085-15004): provides a powerful set of statements and functions for working with both matrices (two-dimensional arrays) and vectors (one-dimensional arrays).

Advanced Programming ROM (00085-15005): adds functions, statements, and commands that give you extended control over data, programs, and system operations.

Assembler ROM (00085-15007): provides the capability to write customized Assembly language programs that can be executed from random access memory.

HP 82928A System Monitor: provides the necessary hardware to debug Assembly language software for Series 80 computers.

HP 82929A Programmable ROM Drawer: enables you to use, in a Series 80 computer, EPROM's that you have created. In conjunction with the Assembler ROM and the System Monitor, this product completes a package designed to supply tools necessary to develop EPROM's for Series 80 computers.

HP 82937A HP-IB Interface: implements the IEEE 488-1978 Standard Digital Interface for programmable instrumentation and is required for interfacing all HP-IB peripherals. It may communicate to as many as 14 HP-IB compatible instruments per interface.

HP 82939A Serial Interface: provides RS-232 compatible I/O for communication with devices such as printers and terminals.

Option 001: serial interface module with male connector for Series 80 computers, typically used with modems.

Option 002: serial interface module with current loop cable for Series 80 computers.



COMPUTERS, PERIPHERALS & CALCULATORS

Personal Computation

Series 80 Peripherals & Interfaces

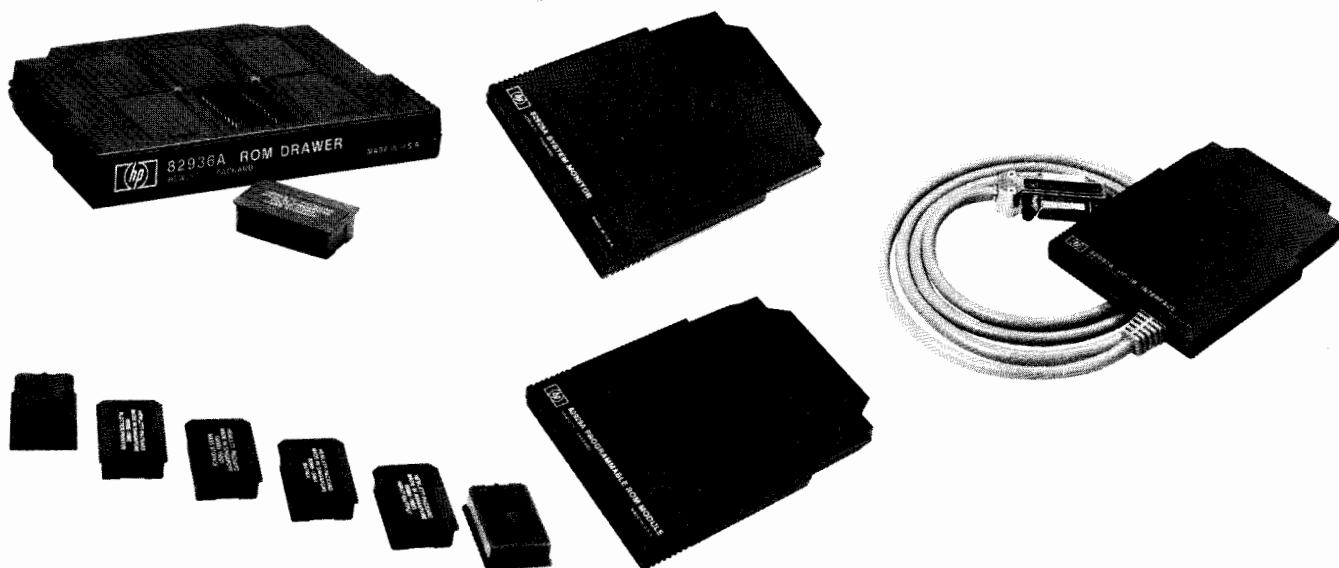

HP 82940A GPIO Interface: provides 16-bit general purpose input/output operations for connection to TTL-type signals.

HP 82941A BCD Interface: provides the hardware necessary for connection to devices having BCD (binary coded decimal) outputs.

HP 82949A Printer Interface: standard 8-bit parallel printer interface module for connecting printers with a Centronics-type interface.

Series 80 Interfacing Systems

HP-85F Interfacing System

Includes: HP-85A, HP 82936A ROM Drawer, I/O ROM (00085-15003), and HP 82937A HP-IB Interface.

HP-85F Interfacing System Option 001

Includes: HP-85A, HP 82936A ROM Drawer, I/O ROM (00085-15003), and HP 82939A Serial Interface.

HP-85F Interfacing System Option 002

Includes: HP-85A, HP 82936A ROM Drawer, I/O ROM (00085-15003), and HP 82939A Option 001 Serial Interface.

HP-85F Interfacing System Option 003

Includes: HP-85A, HP 82936A ROM Drawer, I/O ROM (00085-15003), and HP 82939A Option 002 Serial Interface.

HP-85F Interfacing System Option 004

Includes: HP-85A, HP 82936A ROM Drawer, I/O ROM (00085-15003), and HP 82940A GPIO Interface.

HP-85F Interfacing System Option 005

Includes: HP-85A, HP 82936A ROM Drawer, I/O ROM (00085-15003), and HP 82941A BCD Interface.

HP-83F Interfacing System

Includes: HP-83A, HP 82936A ROM Drawer, I/O ROM (00085-15003), and HP 82937A HP-IB Interface.

HP-83F Interfacing System Option 001

Includes: HP-83A, HP 82936A ROM Drawer, I/O ROM (00085-15003), and HP 82939A Serial Interface (female).

HP-83F Interfacing System Option 002

Includes: HP-83A, HP 82936A ROM Drawer, I/O ROM (00085-15003), and HP 82939A Option 001 Serial Interface (male).

HP-83F Interfacing System Option 003

Includes: HP-83A, HP 82936A ROM Drawer, I/O ROM (00085-15003), and HP 82939A Option 001 Serial Interface, current loop.

HP-83F Interfacing System Option 004

Includes: HP-83A, HP 82936A ROM Drawer, I/O ROM (00085-15003), and HP 82940A GPIO Interface.

HP-83F Interfacing System Option 005

Includes: HP-83A, HP 82936A ROM Drawer, I/O ROM (00085-15003), and HP 82941A BCD Interface.

Ordering Information

	Price
HP 82936A ROM Drawer	\$45.00
00085-15001 Mass Storage ROM	\$145.00
00085-15002 Plotter/Printer ROM	\$145.00
00085-15003 I/O ROM	\$295.00
00085-15004 Matrix ROM	\$145.00
00085-15005 Advanced Programming ROM	\$145.00
00085-15007 Assembler ROM	\$295.00
HP 82928A System Monitor	\$295.00
HP 82929A Programmable ROM Drawer	\$195.00
HP 82937A HP-IB Interface	\$395.00
HP 82939A Serial Interface	\$395.00
HP 82939A Option 001 Serial Interface	\$395.00
HP 82939A Option 002 Serial Interface	\$395.00
HP 82940A GPIO Interface	\$495.00
HP 82941A BCD Interface	\$495.00
HP 82949A Printer Interface	\$295.00
HP-85F Interfacing System	\$3985.00
HP-85F Option 001 Interfacing System	\$3985.00
HP-85F Option 002 Interfacing System	\$3985.00
HP-85F Option 003 Interfacing System	\$3985.00
HP-85F Option 004 Interfacing System	\$4085.00
HP-85F Option 005 Interfacing System	\$4085.00
HP-83F Interfacing System	\$2985.00
HP-83F Option 001 Interfacing System	\$2985.00
HP-83F Option 002 Interfacing System	\$2985.00
HP-83F Option 003 Interfacing System	\$2985.00
HP-83F Option 004 Interfacing System	\$3085.00
HP-83F Option 005 Interfacing System	\$3085.00

COMPUTERS, PERIPHERALS & CALCULATORS

Personal Computation

Series 80 Software

657

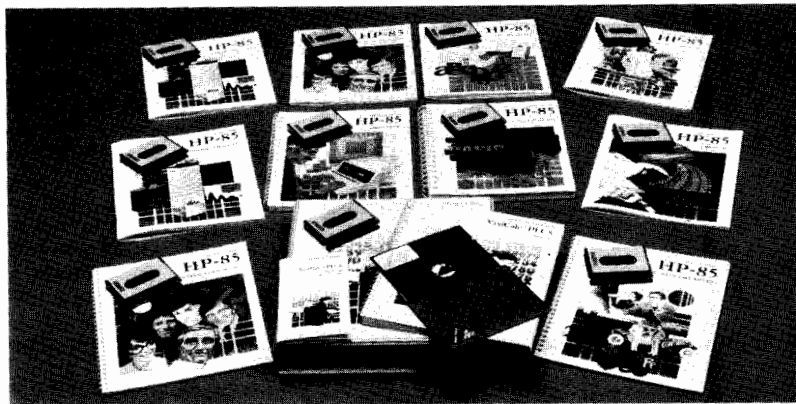
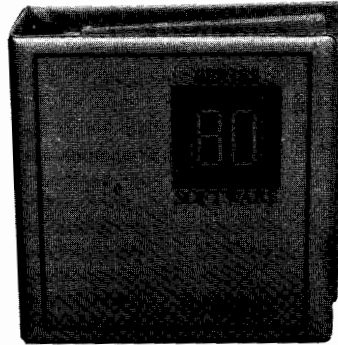

Series 80 Software

When equipped with Series 80 software, your Series 80 computer gives you fast, powerful and convenient solutions. Choose from application pacs, solution books and programs from the Users' Library, or offerings from third-party software suppliers. You'll find Series 80 software provides affordable programs in specific application areas that enable you to concentrate on decision making.

Series 80 Application Pacs

- BASIC Training
- Graphics Presentations
- VisiCalc PLUS
- Information Management
- Financial Decisions
- Linear Programming
- Text Editing
- Math
- Data Communications
- General Statistics
- Basic Statistics and Data Manipulation
- Regression Analysis
- AC Circuit Analysis
- Waveform Analysis
- Surveying
- Games
- Games II

Series 80 Solution Books

Business

- Stocks & Bonds
- Securities & Investment Analysis
- Budgeting & Finance I
- Budgeting & Finance II
- Management Science
- Real Estate

Educational Series

- Math Learning
- Science Learning I
- Science Learning II
- Electrical Engineer Learning

Engineering Series

- Electrical Engineering

Recreational Series

- Games

Scientific Series

- Math
- Numerical Analysis
- General Probability
- Decision Analysis

Series 80 Utility Software

- Data Exchange Utility

Series 80 Software Supplier Program

Third-party software solutions exist for such applications as:

- Information Management
- Text Preparation
- Accounting
- Real Estate Analysis
- Structural Engineering
- Chemical Engineering
- Design & Mapping

Series 80 Software Catalog

All programs available for Series 80 computers are described, in summary form, in the *Series 80 Software Catalog*. The catalog is updated on a regular basis to include new software summaries and to keep existing summaries current. As the authoritative source of Series 80 software, the catalog is available to members of the Series 80 Users' Library and to authorized HP personal computer dealers.

Ordering Information

	Price
00085-13002 BASIC Training	\$95.00
00085-13038 Graphics Presentations	\$200.00
00085-13042 VisiCalc PLUS	\$200.00
00085-13045 Information Management	\$200.00
00085-13004 Financial Decisions	\$95.00
00085-13011 Linear Programming	\$95.00
00085-13034 Text Editing	\$95.00
00085-13005 Math	\$95.00
00085-13044 Data Communications	\$200.00
00085-13003 General Statistics	\$95.00
00085-13036 Basic Statistics and Data Manipulation	\$95.00
00085-13037 Regression Analysis	\$95.00
00085-13006 AC Circuit Analysis	\$95.00
00085-13035 Waveform Analysis	\$95.00
00085-13046 Surveying	\$200.00
00085-13010 Games	\$95.00
00085-13057 Games II	\$95.00
Series 80 Solution Books	\$10.00 ea.
HP 88095A Data Exchange Utility	\$95.00



COMPUTERS, PERIPHERALS & CALCULATORS

Desktop Computers

Model 9826



- Multiple languages (BASIC, HPL, Pascal)
- Graphics capability
- 7-inch shaded CRT
- Read/write memory up to 512K bytes
- Typewriter-like keyboard with numeric pad
- Built-in 260K-byte flexible disc

instruments, peripherals and even other computing systems. Installation is simply a matter of setting address switches and inserting the board into one of the slots.

All I/O cards have been designed to be functionally compatible with I/O cards used by the HP 9825, 9835 and 9845 at the peripheral or device end. Built-in I/O drivers eliminate the problem of writing drivers or low-level commands by automatically handling I/O formatting and communications with the interface cards.

The HP 9826 Computer System

The HP 9826 is Hewlett-Packard's newest desktop computer. An integrated system, it incorporates a 16-bit microprocessor, read/write memory of up to 512K bytes, alphanumeric and graphics display, multiple language capability, CRT, typewriter-like keyboard with numeric pad, flexible disc drive and real-time clock.

The 9826 is an advanced power tool that finds ideal application in computer-aided testing, although its high computation speed (two to five times as fast as the HP 9825) makes it effective in such areas as computer-aided engineering and manufacturing as well. It has proven particularly useful in laboratory instrument automation, production testing and quality control.

The 9826's data display graphics lets you view all computational results. The computer can also output results as hard copy via an external printer or plotter. The 9826 has a 7-inch CRT with a raster of 300 by 400 dots, ten programmable softkeys (with shift), and 15 levels of priority program interrupt.

Multiple Languages

The HP 9826 features three languages—BASIC, HPL and Pascal—allowing you to choose the language that best suits your applications.

HP 9826 BASIC builds on earlier versions of BASIC and includes enhancements from FORTRAN, ALGOL and APL. It is a high-performance language especially suited to the I/O-oriented user's needs.

HPL is a concise and effective language that meets the requirements of the engineer or scientist. Its features include formula-oriented syntax, explicit I/O control, and high speed I/O and computing. It is upward compatible with programs written for the 9825 computer system.

Pascal is a forward-looking language that provides "top-down" programming structure and ease of writing, debugging and maintenance. All three languages are available in both RAM and ROM configurations.

I/O Flexibility

Flexible I/O allows you to tailor the 9826 to your particular applications. A wide variety of data formats minimizes system alterations. Insertable I/O cards provide easy interfacing to a wide range of

Interfacing Capability

The HP 9826 features a built-in HP-IB (IEEE 488-1978) interface that allows the widest degree of flexibility when connecting with instruments and peripherals. The HP-IB control language is simple yet powerful, allowing extensive control of external devices.

In addition to the built-in HP-IB interface, there are five external interface cards: GPIO (98622A) for bidirectional information transfer, BCD (98623A) for bit-parallel, digit-parallel and binary coded decimal devices, HP-IB (98624A) to augment the built-in HP-IB, Serial (98626A) for bit-serial communication to some asynchronous devices, Data Communication (98628A) for other asynchronous devices, and a 2-channel DMA Controller (98620A) for high-speed I/O.

Additional Features

Contributing to the speed and versatility of the 9826 are a new 16-bit Motorola MC68000 CPU with a built-in 8 MHz clock, a 133mm (5¼ inch) flexible disc with 260K-byte capacity, a rotary control knob for "analog" program control, a 128-character (ASCII) keyboard with ten (20 with shift) softkeys, and special function keys for program editing, cursor control and system control.

Keyboards are available in English, French, German, Spanish, Swedish-Finnish and Japanese. A number of prewritten software packages, such as numerical analysis, statistics and regression analysis, allow the user to quickly apply the 9826 to these areas. Graphics and alphanumerics can be easily transferred to hard copy via an external printer.

Ordering Information

Price

The HP 9826 Computer System includes graphics, CRT, Internal HP-IB and 260K-byte disc drive. It is available in the following options:

Opt. 001	9826A with ROM-Based BASIC language	\$8,950
Opt. 701	9826A with RAM-based BASIC language System (66K bytes user r/w memory)	\$11,950
Opt. 004	9826A with ROM-based HPL language System (56K bytes user r/w memory)	\$8,950
Opt. 704	9826A with RAM-based HPL Language System (24K bytes user r/w memory)	\$8,950
Opt. 005	Pascal Language System (available early 1982)	

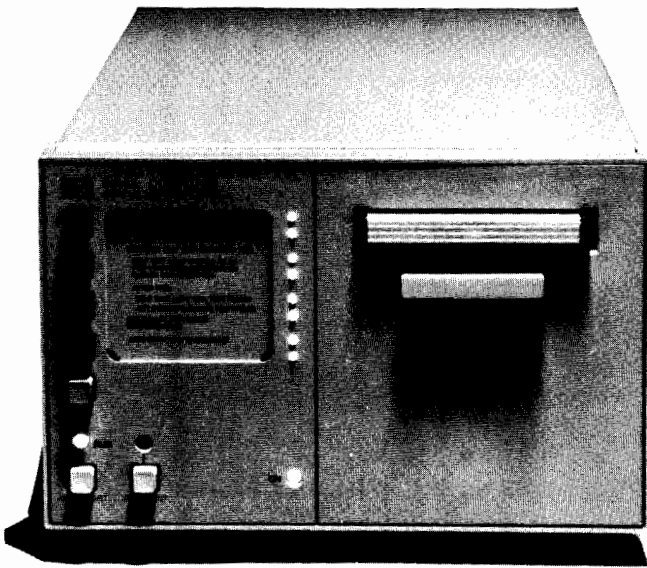

- Heart of the HP-85 Desktop Computer—central processor, memory, operating system and I/O ports
- 16K bytes of read/write memory, expandable to 32K bytes
- Rack-mountable for easy integration into total system
- Powerful BASIC-language operating system
- Same powerful graphics capability as the HP-85
- Custom operator interface—remote buttons, LEDs, keyboard and CRT can be added for more operator control

The HP 9915A is a modular computer that contains the heart of the HP-85 desktop system, but without the associated keyboard, CRT and tape drive. This makes it ideal for integration into an automated system, omitting features not needed in a preprogrammed controller. Its optimal applications are in automated testing, measurement and control.

At one end of the spectrum, it provides an alternative to microprocessors and board computers that are inexpensive but difficult to engineer, program and develop. At the other end, it supplants mini-computer systems that are powerful and effective, but also more expensive and difficult to use. In the middle, it is a viable alternative to desktop computers—ideal for the application but until now unavailable without the associated features and peripherals.

Efficient Program Development

The HP 9915A is designed to run programs developed on the HP-85. With a program development ROM and an I/O ROM, the HP-85, featuring a powerful, interactive, BASIC-language operating system, becomes the perfect development station and emulator for the 9915A. A typical development scenario would include writing the application program and debugging it on the HP-85, transferring the software to the 9915A via either EPROM or magnetic tape and running it on the 9915A. Applications can be running in half the time it would take for a microprocessor or board computer, and at about half the cost of the HP-85.

The 9915A can accept up to 32K bytes of EPROM-stored programs. Software is available for the HP-85 that makes it possible for the designer to program EPROMs with any of several commercially available PROM programmers.

Flexible Design for Operator Interface

The 9915A is designed for easy operator use, but more extensive controls can be provided as needed. For applications requiring mini-

mal or no attention, the 9915A's extensive SELF TEST, AUTO-START and front panel lights will suffice. For moderate operator interface, there are eight software-definable functions (four shiftable keys). For extensive operator control, a number of peripherals can be added, including remote pushbuttons and/or LEDs, large or small CRT displays and numeric typewriter or custom keyboards.

Since all of the HP-85's sophisticated graphics capabilities are built into the 9915A, charts, histograms, block diagrams and other graphics may be easily displayed via an external CRT. All necessary interfaces and I/O drivers are available with the operator interface option.

I/O Capabilities

The HP-85/9915A BASIC language includes a powerful set of statements to simplify I/O, providing the user with interrupt, bit manipulation, high-speed transfer, software control of interface and easy data formatting. I/O drivers are built-in, and both machines use the same plug-in interfaces: HP-IB (IEEE Standard 488-1978), serial (8-bit/16-bit parallel) and binary coded decimal. With the TIMEOUT and error-trapping features, subroutines can be written to handle various problem situations, thus minimizing operator intervention.

Additional Features

A complete line of peripherals is available for the 9915A, including printers, plotters and flexible disc drives. HP multiprogrammers are available for analog input and output, digital input and output, stepper motor control, timing and counting. An optional tape unit is available when it is necessary to change programs often or record test data; its capacity is 200K bytes, depending on whether the stored information is programs or data.

Ordering Information

		Price
9915A	Modular Computer with 16K memory, I/O ROM and Program Development ROM	\$1675
Opt. 001	Built-in Tape Drive	475
Opt. 002	Operator Interface Capability (for commercial video monitors, keyboards and remote front panel control)	350



COMPUTERS, PERIPHERALS & CALCULATORS

Desktop Computers

HP 9835A/B Computer System



HP 9835A



HP 9835A/B

The HP 9835 is a powerful, integrated desktop computer that is ideal for many scientific, manufacturing and engineering applications involving computation, data acquisition, instrument control, production/process control, engineering design, automation and statistical/numerical analysis. It offers a large user-available memory (64K bytes expandable to 256K bytes), a built-in tape cartridge drive (217K bytes/tape), an optional CRT display, a built-in 16 column thermal line printer (optional) and an impressive array of interfacing and I/O capabilities.

The 9835 has the power you'd expect from a mini-computer, yet it retains the friendliness of an HP Desktop computer in both system design and programming language.

Languages

BASIC

The 9835's HP Enhanced BASIC is easy to learn and use, yet it is much more powerful than the standard ANSI BASIC. It offers many of the convenient features of FORTRAN and APL including subprograms, multi-dimensional numeric arrays, string arrays, and multi-character identifiers. An option provides the 9835 with several structured BASIC statements. These include looping constructs such as REPEAT...UNTIL, WHILE...END WHILE, LOOP EXIT IF...END LOOP; decision constructs such as IF...THEN...ELSE and SELECT (CASE) statements; and two documentation aids, INDENT and XREF.

Assembly. The 9835 can also be programmed in Assembly Language by experienced programmers. For certain specialized computational and I/O operations, Assembly programming can increase program execution speeds by a factor of 100 or more. For more general applications, Assembly Language may be of little benefit. Assembly Language capability is available as a set of optional 9835 Read-Only Memories (ROMs).

- Complete I/O capability
- User R/W memory from 64K to 256K bytes
- HP Enhanced BASIC
- Assembly Language and Structured Programming options
- Optional CRT
- Built-in thermal line printer (optional) and tape cartridge drive
- Interactive keyboard
- Data Comm capability
- Wide range of peripherals



HP 9835B



CRT

The optional 12 in. (diag.), monochromatic CRT (available on the 9835A) can display 20 lines of alphanumeric program or data at a time. Each line can contain up to 80 characters. If a CRT is not needed, the 9835B has a 32-character single-line LED display.

Data Communications

An optional High Speed Asynchronous Datacomm package is available to allow the 9835 to connect to a large host computer. It provides for emulation of an alphanumeric or Tektronix 4010 graphics terminal. An RJE Bisync package permits the 9835 to communicate with most host computers that support an IBM 2780 or 3780 terminal. Also, two new software/firmware packages allow connections to the HP 1000 and HP 3000 computer systems via HP distributed systems.

The optional I/O ROM (98332A) provides buffered I/O, DMA, fast read/write, 15 levels of priority interrupt and built-in I/O drivers. A time-out feature avoids deadlocks.

Ready made, plug-in HP Interface Cards are available to simplify system hook-up. They are the HP-IB (IEEE 488-1978), Bit Parallel, Bit Serial and BCD Cards. The 9835 has three I/O ports to accept these cards. I/O expanders can provide six more I/O slots each to interface to even more instruments and peripherals.

A complete line of peripherals is available: printers, plotters, paper tape punches and readers, card readers, digitizer, cartridge tape drives and flexible or hard disc drives.

Ordering Information

9835A Desktop Computer, includes 65 536 total bytes read/write memory of which 49 880 are available to the user, alphanumeric CRT, ASCII character set and built-in tape cartridge drive.

9835B Desktop Computer, includes 65 536 total bytes read/write memory of which 56 772 are available to the user, 32-character LED single-line display, ASCII character set and built-in tape cartridge drive.

9835A Desktop Computer
9835B Desktop Computer

Price
\$10,900
\$9,150



HP 9845C



HP 9845B



HP 9845 Desktop Computer

The 9845 is HP's most powerful desktop computer. It is ideally suited for engineering design, statistical/numerical analysis, mathematical modeling, data acquisition/control, business management and process monitoring. It offers a totally integrated system with a CRT display, built-in page-width printer (optional), tape cartridge drives, interactive keyboard and dual processors.

The 9845 offers several models from which to choose, but there are two basic configurations: the 9845B and the 9845C. The 9845B provides 56K to 449K bytes of user-available internal memory, a monochromatic CRT with full graphics capability, language-expanding read-only memories (ROMs) and HP enhanced BASIC programming. A new high-performance version of the 9845B (9845B, Models 2XX) features a bit-slice processor and high-speed CRT enhancements.

The 9845C offers all the benefits of the 9845B plus a full-color graphics CRT package that provides up to 4,913 different colors, high-speed vector writing and an interactive light pen. There is also a high-performance 9845C version (9845C, Models 2XX) that features the bit-slice language processor.

CRT

The 9845 CRT, whether it is monochromatic or color, is an integral part of the 9845's chassis. It is a flicker-free, raster-scan device with a refresh rate of 60 times/sec. It offers high-speed listing, upper and lower case characters, inverse video, blinking and underlining. It features both alphanumeric and graphics modes. The alphanumeric mode's 24 line by 80 character display lets you view data, list programs and display keyboard input. The graphics mode allows high-speed, interactive plotting within a 560 by 455 dot matrix.

The 9845's color CRT features a high-resolution, tri-color, shadow mask tube with software-assisted color convergence tuning and a high-speed vector generator. For interactive design applications, an optional light pen offers a fast, easy way to pick, move and construct objects right on the CRT screen.

HP Enhanced BASIC

The 9845's enhanced BASIC language is much more powerful than typical BASIC languages. It offers many of the powerful features of FORTRAN and APL. For example, it provides for unified mass storage operations. No matter which storage device you choose, you use the same set of statements to address the medium, whether it is a flexible disc, cartridge disc or the 9845's built-in 217K-byte tape cartridge.

The 9845 can also be programmed in Assembly Language by experienced programmers. For certain computation-intensive or I/O routines, Assembly Language can increase program execution speeds by as much as 100 times.

Thermal Printer

The 9845's optional built-in thermal line printer prints up to 80 characters per line at up to 480 lines per minute, and plots at about 25.4 mm/s (1 in./s). The printer gives you high quality copy with standard ASCII upper and lowercase characters. CRT screen graphics can be transferred directly to the printer for fast, precise hard-copy output.

Interfacing Capability

The 9845 has a wide range of interfacing capabilities for peripheral/instrument control. It features 15 levels of programmable priority interrupt, DMA, buffered I/O and overlapped processing. Interface types include: BCD, bit parallel, bit serial (RS-232-C), HP-IB (IEEE 488-1978), real time clock, incremental plotter and disc interface. A complete line of HP peripherals is also available.

Additional Capabilities

The 9845 also offers an IMAGE Data Base Management software/firmware package that allows you to define, build, maintain, access, restructure and back up a data base that can be tailored to your unique needs. The package also includes QUERY/45, the primary data base manipulation software tool for programmers and nonprogrammers.

The 9845 also offers a sophisticated Data Communications capability that can be configured to allow the desktop computer to connect to a host computer via a hardwired or modem link. Asynchronous, RJE Bisync, Distributed Systems and Data Link connections are all available as software/firmware packages.

Ordering Information

When ordering the 9845, be sure to specify the proper model number.

Product	Price
9845B Desktop Computer	
Model 100 (minimum system)	\$14,500
Model 150 (standard system)	\$24,500
Model 190 (expanded system)	\$35,000
High Performance Models	
Model 200 (minimum system)	\$20,000
Model 250 (standard system)	\$28,000
Model 270 (graphics system)	\$32,000
Model 290 (expanded system)	\$38,000
9845C Desktop Computer	
Model 100 (minimum system)	\$33,500
Model 150 (standard system)	\$41,500
Model 190 (expanded system)	\$52,000
High Performance Models	
Model 200 (minimum system)	\$35,500
Model 250 (standard system)	\$43,500
Model 270 (graphics system)	\$47,500
Model 290 (expanded system)	\$54,000



COMPUTERS, PERIPHERALS & CALCULATORS

Desktop Computers

Models 97S, 9815S, 9825B, 9825T



97S

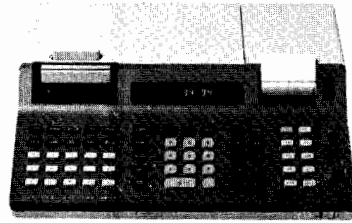

9815S



97S

Flexible and simple interfacing is a design feature that makes the 97S a cost-effective solution for low-cost BCD data acquisition applications. In addition to the features of the 97A Scientific Programmable Calculator, the 97S allows a reading of up to 10 BCD digits to be input to the calculator at about 1 reading per second. Comparisons of input data with standards or other computations can then be easily performed. Magnetic cards provide data or program storage and an internal thermal printer provides hard copy output.

Instruments interfaced to the 97S include electronic balances, gaging and measurement systems, spectrophotometers, gamma counters, and chemical analyzers. A manual with all technical data and examples is included. A data sheet and supplement describing the interfacing with examples is available.

9815S

The 9815S offers economical solutions to dedicated data acquisition and computation problems. The integration of peripherals into a small package, plus price/performance flexibility, provide attractive solutions for OEMs.

Single keystrokes provide math and transcendental functions. For repetitive problem solving, simply program the keystrokes into the computer memory. The 9815S offers 3800 program steps. Ten data registers are always available and program steps can be assigned as additional data registers. The efficient RPN programming language has enhanced features such as FOR-NEXT loops, symbolic and calculated branching and nesting of subroutines. Fifteen keys can be defined to provide special functions by simply pressing a key.

The tape drive allows up to 96K bytes of program or data storage and a numeric display and 16-character alphanumeric printer are included. With the Auto-start feature, simply inserting a tape cartridge and turning on the machine will load the first program and run it, prompting the user for interaction. Operation of a system thus requires minimal operator training.

Two I/O channels allow use in data acquisition and control applications. The 98133A BCD interface allows 9-digit input at up to 2000 readings per second as well as an 8-bit output. The 98134A is a general purpose bidirectional 8-bit parallel interface providing transfer rates of up to 800 bytes/sec. The 98135A provides HP-IB compatibility. Up to 14 peripherals and instruments can be interconnected to one HP-IB interface. RS232C compatible serial I/O as well as current-loop receive-only capability is available with the 98136A. Peripherals are interfaced using standard interfaces. In addition to printers and digitizers, a paper tape punch and a low-cost plotter are available.

Software packages for Statistics and Financial Analysis and Electrical Engineering are also available.



9825B / T

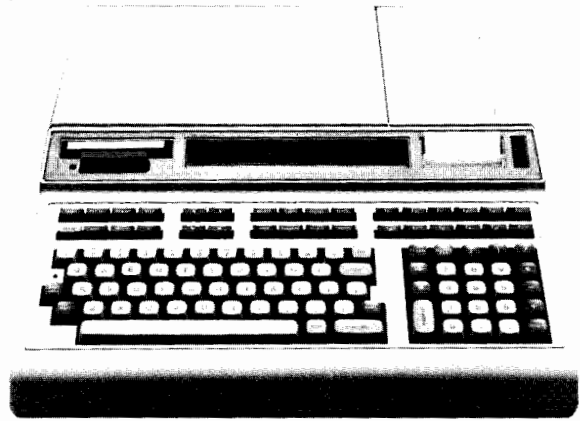

9825B / T

The 9825B or 9825T Desktop Computer offers many features previously found only on minicomputers. It is particularly suited to controller applications and is a powerful stand-alone device. The 9825T includes a larger memory than the 9825B.

Packaged System

Both the 9825B and the 9825T provide a compact computing system with built-in peripherals. The 9825B includes 23K bytes of read/write memory and internally integrated ROMs (read-only memories) for Strings, Advanced Programming, Plotters, General I/O and Extended I/O. The 9825T has 62K bytes of read/write memory, all the built-in ROMs of the 9825B plus a built-in Systems Programming ROM.

A 32-character LED display and a built-in 16-character thermal printer provide alphanumeric readout including both capital and lower case letters. The high-speed bidirectional data cartridge holds 250K bytes and has an average access time of 6 seconds to any place on the tape. File verification is automatic on recording.

Twelve Special Function keys on the keyboard, combined with the shift key, can handle 24 different operations. They can serve as immediate execute keys, as call keys for subroutines, and as typing aids.

Powerful Programming

The 9825 is programmed in HPL, a high-level, formula-oriented language. HPL provides for subroutine nesting and flags and allows 26 simple variables and 26 multidimensional array variables, limited only by the size of the 9825's memory. Fixed- and floating-point formats can be set from the keyboard. Syntax checking is simple: a flashing cursor in the display identifies error locations.

The 9825 offers several contributions that make it a powerful and flexible programmable computer. Live keyboard lets the user examine and change program variables, perform complex calculations, call subroutines, and record or list programs while the 9825 is performing other operations. The internal calculation range is $\pm 10^{911}$ to $\pm 10^{-511}$. The tape cassette can be used to record and load the entire memory automatically.

I/O Performance

Three I/O slots accept standard interface cards offering 16-bit parallel, BCD, serial, or HP-IB communication with instruments and peripherals. Code conversion logic is available to interpret a variety of machine codes. High-speed I/O handles data input speeds up to 400K 16-bit words/second. This is all accessible through formatted and binary read/write instructions in the HPL language.

With two-level priority interrupt, available in the Extended I/O ROM, the 9825 will act as a controller for several instruments or peripherals requiring attention at unpredictable rates or times. Stand-alone controlling is enhanced with auto restart and interface status testing.

Ordering Information

	Price
97S I/O Calculator	\$1445
97SD Five 97S I/O Calculators	\$6860
9815S Desktop Computer	\$3990
9825B Desktop Computer	\$8100
9825T Desktop Computer	\$8600

COMPUTERS, PERIPHERALS & CALCULATORS

Dedicated Real-Time Computer Systems

HP 1000 Systems

663



- Computation
- Industrial automation

- Instrumentation
- Automatic test systems

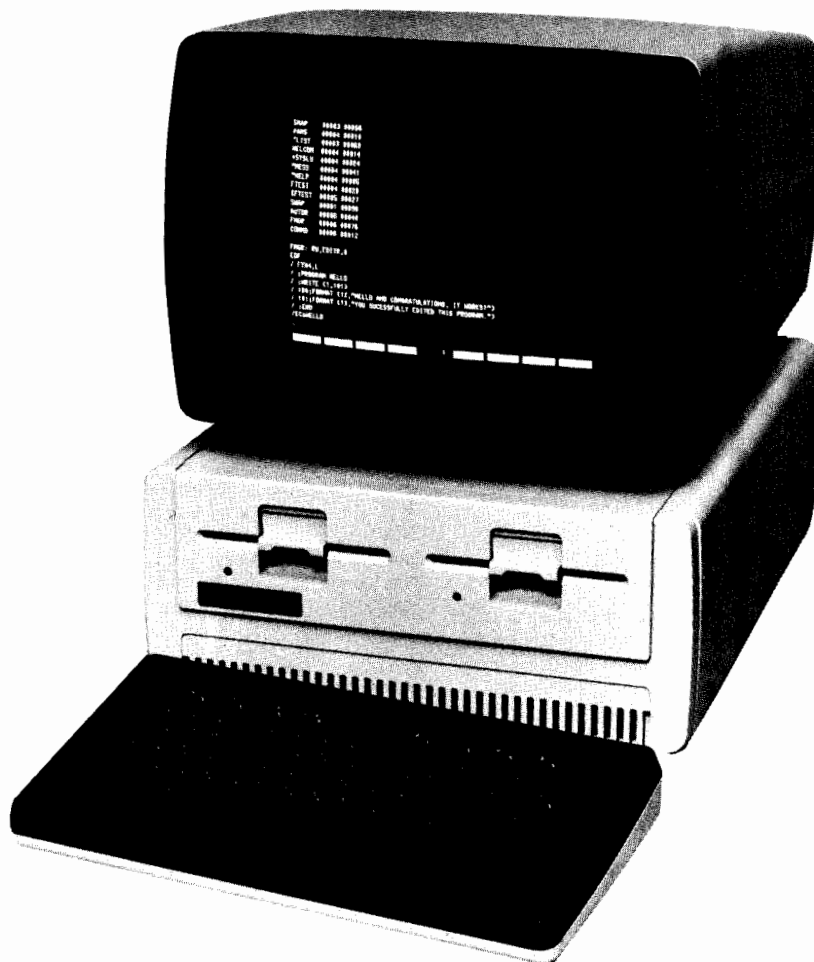

HP 1000 L-Series Microcomputers: Lower cost, and increased flexibility, for OEM's and end users alike

The HP 1000 L-Series is a recent, low-cost addition to the Hewlett-Packard family of technical real-time computers. It is a new concept in LSI-based computer products because it puts two kinds of advanced processors to work in one computer. Both processors are the result of HP's CMOS/SOS (Silicon On Sapphire) Large Scale Integration manufacturing process.

One SOS circuit is the L-Series central processor. The other SOS processor is used on each L-Series interface board. Placing a small but powerful processor on every I/O board creates a new "Distributed Intelligence" architecture with vastly improved I/O efficiency and flexibility. While priced like an LSI microcomputer, the L-Series provides a significant improvement in price/performance for this category of computers.

L-Series products are available in board, box and system configurations. For maximum packaging flexibility, OEM's can choose from card cages and both general-purpose and specialized I/O boards to put the L-Series to work in their products.

HP 1000 Computers—Flexibility and Compatibility for Your Application

With the HP 1000 family of real-time computers, tailoring a computer solution to your application is a simple matter of choice. You begin by selecting the computer power you need from three series of HP 1000 computers. Then you choose from three levels of packaging—from component-level board computers all the way up to a total-

ly-integrated computer system. Then you can further fine-tune your HP 1000 to your intended task by choosing from an array of specific hardware and software products designed to help you get results over a wide range of specific applications.

Compatibility of design throughout the HP 1000 family is the fundamental element that enables you to harness the specific level of power you need to a specific application. It also gives you a clear growth path. Once you've matched the proper combination of HP 1000 products to your initial needs, you remain free to choose an impressive number of options to keep pace with your growth. Or, if your needs change or shift, you can smoothly reconfigure your HP 1000 to handle new applications. This compatibility extends through:

- HP 1000 computers. Because the L, E, and F-series computers use the same basic instruction set, you can change models with minimal effect on software, peripherals and operator training.
- HP 1000 systems. You can upgrade from the smallest memory-based system to the largest disc-based system at any time you choose, at once or in gradual increments.
- HP 1000 software. HP's Real-Time Executive (RTE) operating systems are upward-compatible—your programming investment is protected because application programs written for one RTE system will execute on the others with minimal modification.
- HP 1000 applications-oriented software. To wield more computer power, you can superimpose HP 1000 applications software products on your system to move even closer to a computer solution for your specific application.



COMPUTERS, PERIPHERALS & CALCULATORS

Dedicated Real-Time Computer Systems

HP 1000 Systems

HP 1000 Computer Systems

The HP 1000 system family consists of both memory-based systems and disc-based systems for powerful computation and measurement/control applications.

The Model 5 uses the low-cost L-Series LSI computers. The Model 40 utilizes an E-series computer, while the Model 45 features the F-series computer with hardware Floating Point Processor and Scientific Instruction Set which speed calculations.

HP 1000 systems feature a Real-Time Executive (RTE) operating system and are programmable in FORTRAN, PASCAL, BASIC, Assembly Language, and Micro-assembly Language.

Computation

Model 45 combines the fast F-series computer with powerful RTE-IVB software to provide processing speed and power unique for this price range. The system can process data arrays as large as 2.048 M bytes directly in physical memory, without time-consuming disc swaps. GRAPHICS/1000 software formats output in plots and pictures that are easier to interpret. The Model 45 also includes a Vector Instruction Set which significantly reduces the time required for matrix and vector computations.

Instrumentation

HP 1000 systems are also designed for control and interaction with HP-IB instruments. Up to 14 HP-IB devices connect to the system via a single interface card, so that the system can control multiple test or measurement stations. For small analog input needs, the 91000A plug-in card adds a capacity of 16 single-ended or 8 differential ± 10 V fs analog inputs.

Operations Management

Two optional software packages, DATACAP/1000-II and IMAGE/1000, aid operations management. DATACAP/1000-II is designed for automatic factory data capture from multiple terminals (e.g., test records, order entry, or inventory control). IMAGE/1000, data base management software, simplifies building and maintaining a large data base.

Distributed Systems Network

An important feature of HP real-time systems is their ability to be linked together to form a large multi-system network. DS/1000-IV software/firmware interfaces multiple HP 1000 systems to each other or to a larger HP 3000 system. RJE/1000 provides direct communication between HP 1000 systems and most IBM 360/370 installations.

A Choice of Computer Systems

Model 5 includes an L-series computer with 128 k bytes of memory, RTE-XL software, a system console with CRT display, and up to a 19.6 M byte disc.

Model 40 includes an E-series computer with 128 k bytes of memory, RTE-IVB software, system console with CRT and a 19.6 M byte disc.

Model 45 features the fast F-series computer with 128 k bytes of high performance memory, RTE-IVB and GRAPHICS/1000 software, Vector Instruction Set, system console with graphics display terminal, and a 19.6 M byte disc.

Ordering Information

HP 1000/5 Computer System	Price \$10,600
HP 1000/40 Computer System	\$40,700
HP 1000/45 Computer System	\$50,700

HP 1000 System Compatibility Summary

	MODEL 5	MODEL 40		MODEL 45	
	2142A	2176C	2176D	2177C	2177D
Base system computer type	L-Series	E-Series		F-Series	
Type of memory	Std performance	Std performance		High performance	
Memory cycle time	680 ns	595 ns		350 ns	
Operating system	RTE-XL	RTE-IVB		RTE-IVB	
System console	2621A	2645A		2648A	
Memory: Base (bytes) Maximum	128 k 512 k	128 k 2048 k	128 k 1280 k	128 k 2048 k	128 k 1280 k
Standard system disc	None	7906 (19.6 Mb)		7906 (19.6 Mb)	
Optional alternate system discs	7906 7910	7920 (50 Mb) or 7925 (120 Mb)	7920 (50 Mb) 7925 (120 Mb)	7920 (50 Mb) 7925 (120 Mb)	7920 (50 Mb) 7925 (120 Mb)
Flexible disc available?	Yes	Yes	Yes	Yes	Yes
RJE/1000 available?	No	Yes	Yes	Yes	Yes
DS/1000-IV available?	Yes	Yes	Yes	Yes	Yes
IMAGE/1000 available?	Yes	Yes	Yes	Yes	Yes
91000A/2313A Analog-digital Subsystem available?	No	Yes	Yes	Yes	Yes
2240A Meas. & Control Processor available?	Yes	Yes	Yes	Yes	Yes
GRAPHICS/1000-II available?	Yes	Yes	Yes	Incl.	Incl.
12790A Multipoint interface available?	No	Yes	Yes	Yes	Yes
12979B Dual-Port I/O Extender available?	No	Yes	No	Yes	No
12990B Memory Extender available?	No	Yes	No	Yes	No
Datacap/1000-II available?	No	Yes	Yes	Yes	Yes
ATS/1000 Integration Services?	No	Yes	Yes	Yes	Yes

COMPUTERS, PERIPHERALS & CALCULATORS

HP 1000 L-Series, E-Series and F-Series Computers

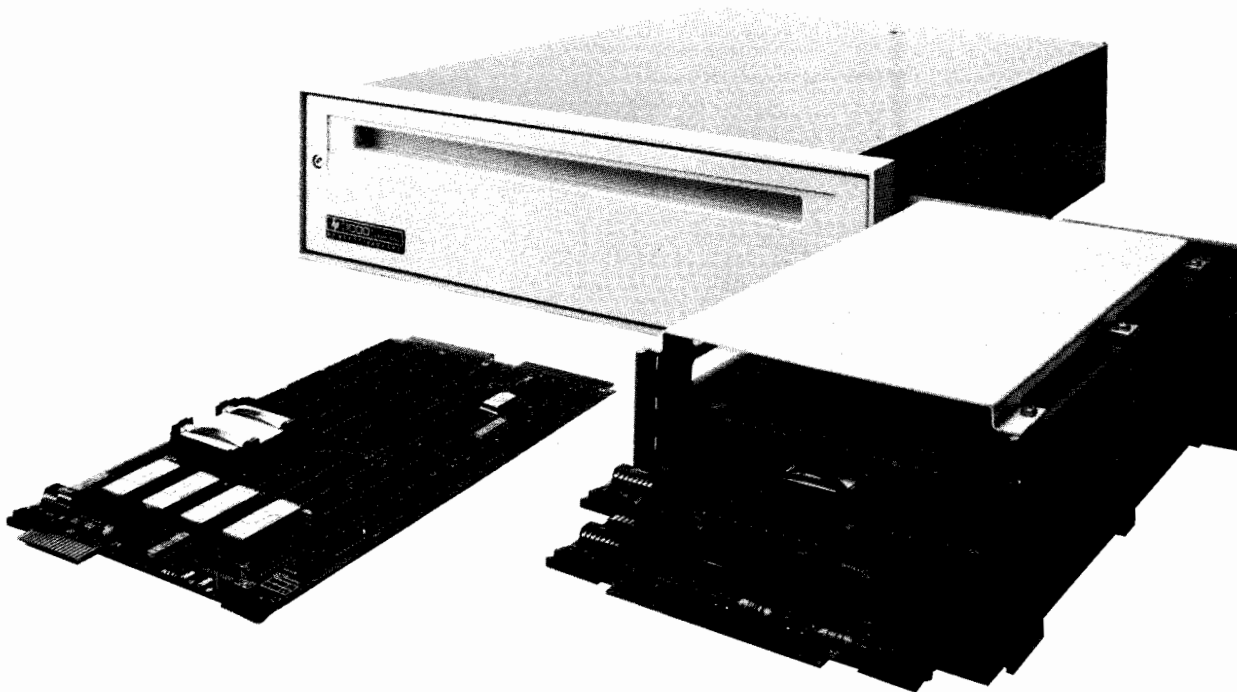

HP 1000 L-Series computer products are available in packaged or component form

HP 1000 L-Series

The low-cost L-Series, designed for I/O-intensive applications and ease of integration into a wide range of OEM and end user products or systems, includes the 2103LK board computer and 2103L rack-mountable computer. Memory capacity is 512K bytes and I/O capacity is 8 channels. Standard features include memory protect, a time base generator, self-test, integer arithmetic, automatic parity generation and checking and virtual control panel. DMA rate is a very fast 2.7M bytes/second.

HP 1000 E-Series

The E-Series computer provides variable microcycle timing, microprogrammable block I/O, a microprocessor port, asynchronous memory, and large control store address space. E-Series computers are available in two models, HP 2109E and 2113E, with a choice of maximum mainframe memory capacities from 640k to 1280k bytes and 9 or 14 I/O channels, expandable to 46 channels. (Also available as a board computer, the HP 2109EK.)

HP 1000 F-Series

For users who need speed, precision and larger memory capacity, HP offers two F-Series computers, 2111F and 2117F. Both feature a hardware Floating Point Processor that speeds calculations (2.5 to 6 times faster than E-Series) and a Scientific Instruction Set for rapid execution of trigonometric and logarithmic functions (compute sine in less than 48 μ s). A Fast FORTRAN Processor, also standard in F-Series computers, provides firmware microcode for more than a dozen instructions—e.g., array address calculations, parameter passing, and other routines—that run 2 to 20 times faster than conventional software execution speed. F-Series computers feature high-performance 350-ns memory and are fully user-microprogrammable.

Alternate Memory Systems

For configuration flexibility, the standard memory in any HP 1000 computer may be deleted at the time of the order, and you can select an alternative memory system of equal or greater size. High-performance 350-ns memory is available as an option for the E-Series.

Fault-control memory, optionally available for most HP 1000 computers, detects and corrects single-bit errors and detects all double-bit errors, thereby improving memory MTBF three times or more.

For compatibility and prices of alternative memory packages, consult your HP field engineer.

Ordering Information

	Price
2103LK L-Series Board Computer w/64Kb memory	\$2,250
2103L L-Series Computer w/64Kb memory	\$4,675
2109EK E-Series Board Computer w/64Kb memory	\$4,095
2109E E-Series Computer w/64Kb memory	\$9,560
2113E E-Series Computer w/128Kb memory	\$11,550
2111F F-Series Computer w/64Kb high-perf. memory	\$14,700
2117F F-Series Computer w/128Kb high-perf. memory	\$18,480
2142A L-Series Model 5 Microsystem w/128 Kb memory	\$10,600
12002B 512 Kb Memory Card	\$5,000
12030A L-Series Board Computer 10-slot card cage	\$445
12032A L-Series Board Computer 5-slot card cage	\$235
12035A L-Series Board Computer power module	\$1,445
12539C Time Base Generator	\$370
12791A Firmware Expansion Module	\$605
12897B Dual Channel Port Controller	\$790
12944B Power Fail Recovery System	\$895
12991B Power Fail Recovery System	\$1,010
12979B I/O Extender	\$6,300
12990B Memory Extender	\$4,725
13047A User Control Store	\$735
13197A Writable Control Store	\$2,100
13306A E-Series Fast FORTRAN Processor	\$685

Quantity discounts are available.

A complete list of computer accessories is available from your HP Sales Office.



COMPUTERS, PERIPHERALS & CALCULATORS

Technical Computer Peripherals Interfacing Summary

Interface ports are included in each Hewlett-Packard technical computer to provide compatibility with a wide variety of HP peripherals, as shown in the following table:

HP Technical Computer Interfacing Summary

Peripherals	Technical Computers									
	Ref Page	83A/ 85A/ 9915	9815S	9825	9826		9835	9845	1000	
					H	B†			E, F Series	L Series
9111A Graphics Tablet	654,692	•		•	•	•		•	•	
9874A Digitizer	692	•		•	•	•	•	•	•	•
9885M/S Flexible Disc Drive	675			•	•		•	•	•	
9895A Flexible Disc Drive	654,674	•		•	•	•	•	•	•	•
82901M & 82902M Flexible Disc Drive	674		•		•	•				
7906M/S Hard Disc Drive	678						•	•	•	
7908P/R Hard Disc Drive	680							•	•	•
7910H/R Hard Disc Drive	679						‡	‡		•
7925M/S Hard Disc Drive	678						•	•	•	
7970B Tape Drive	**								•	
7970E Tape Drive	**						•	•	•	
37203A HP-IB Extender	33	•	•	•			•	•	•	•
9878A I/O Expander	675			•			•	•		
7220C/T Eight-color Plotter	686	*	*	*	*	*	*	*	•	•
7221C/T Eight-color Plotter	686	*		*	*	*	*	*	•	•
9872C/T Eight-color Plotter	686	•	*	•	•	•		•	•	•
7225B Graphics Plotter	654,688	•	•	•	•	•	•	•	•	
7580A Drafting Plotter	690	•	*	•	•	•	•	•	•	•
7240A Plotter/Printer	693	*		•	•	•	•	•		
7245B Plotter/Printer	693	•	*	•	•	•	•	•	•	
2631B Dot Matrix Impact Printer	677	•	•	•			•	•	•	•
2631G Graphics Printer	677	•	*				•	•		
2671A Printer	676	•	•	•			•	•		
2671G Graphics Printer	676	•					•	•		
2673A Intelligent Graphics Printer	676	•					•	•		
9876A Thermal Graphics Printer	675	•	*	•	•	•	•	•	•	
9884A Tape Punch	675		•	•			•	•	•	•
1350S & 1351S Graphic Display System	243		*	•			•	•	•	
2382A Office Display Terminal	668		•	•					•	•
2621A/P CRT Terminal	668		•	•					•	•
2622A Terminal	669		•	•					•	•
2623A Terminal	669		•	•					•	•
2624B Terminal	670		•	•					•	•
2626A Terminal	670								•	
2635B Hard Copy Terminal	677		•	•					•	•
2642A Enhanced Display Station	671								•	•
2645A CRT Terminal	671		*	*					•	•
2647A CRT Graphics Terminal	671		*	*					•	•
2648A CRT Graphics Terminal	671		*	*					•	•
3076A Data Capture Terminal	673		*	*					•	•
3077A Data Capture Terminal	673		*	*					•	•

* Depends on application; not all functions may be implementable.
 ** Call local Hewlett-Packard sales office for technical data sheet.
 † 9826 H = HPL; B = BASIC.
 ‡ 7910H only.

COMPUTERS, PERIPHERALS & CALCULATORS

667

Business Oriented Computer Systems

HP3000, HP300, HP250



HP3000

HP 3000 Business Computer

The HP 3000s are a compatible family of business computer systems for distributed data processing. All models share the same multiprogramming executive operating system (MPE) featuring virtual memory, the same high-level languages, and are able to run one another's programs interchangeably. Full-function general-purpose capabilities include simultaneous transaction-processing, data communication, on-line program development, and batch operations in COBOL, RPG, BASIC, FORTRAN, and SPL (the HP system programming language). Fastest and capable of greatest expansion is the HP 3000 Series 44, with main memory to 4 megabytes, and ability to support as many as 96 terminals, each running or developing separate programs. The SOS (Silicon-on-Sapphire) -based HP 3000 Series 30 offers much the same capability at a less cost. The HP 3000s provide a complete data base management and inquiry facility, IMAGE/QUERY, as well as a data entry/forms generation system, HP VPLUS/3000. In addition, all may be interconnected to allow one to command another's resources sharing files and programs, with HP Distributed Systems Network, DSN/DS/3000, hardware and software that can also integrate HP 3000s with HP 1000 networks and main frames.

HP 3000 Series 44

from \$117,940

HP 3000 Series 30

from \$57,690

HP 300 Business Computer

The HP300 is a full capability, low cost computer system designed for dedicated online business applications. It can address the overall requirements of a smaller organization as well as the specialized needs of a department in a large organization. In either case, the HP 300 can be tailored to optimize each dedicated application environment.

The basic unit includes the Information Display System, built-in disc storage for over 12 million characters, a flexible disc drive for one million character flexible discs, and 256 thousand characters of error correcting solid-state memory.

The HP 300's Fundamental Operating Software includes the Amigo/300 Operating System, the HELP online reference manual and utilities (Sort/Merge, HP 300 Data Utility, Menu Facility, Forms/300, Typist — a text editor, System Build, Diagnostic/Utility Package, and Image/300 Data Base Management including the Data Base Inquiry Facility). Optional languages include FORTRAN 77/300, Business Basic/300, System Language/300, and RPG II/300 (which includes Conversion Utility).

The HP 300 has been designed to accommodate growth in a modular, step-by-step manner. Expansion potential allows up to 1 megabyte of error-correcting main memory, over 490 megabytes of on-line disc storage, 16 application terminals, 2 printers, 2 HP 300 Workstations, and data communications.

HP 300 (12 Mb disc)

\$ 38,325

HP 250 Business Computer

In today's business environment, sound business decisions demand rapid access to information. The sales manager examining month-to-date sales, the purchasing agent planning next month's purchases, the order processing clerk responding to a customer's telephone inquiry—all need accurate, timely information to do their job better. The HP 250 Office Computer Series can help to provide this information, when and where it is needed.

Key features of the HP 250 computer system include:

Large System Capability: Extensive operating software and state-of-the-art hardware offer a powerful foundation for application design, with capabilities usually found only on much larger systems.

Ease of Operation: "Softkey"-driven* processing, and full-screen display forms that closely resemble ordinary business forms simplify and streamline applications use.

Interactive, Multi-user Processing: The HP 250, through its personal workstations, offers users on-line, responsive access to accurate, timely information.

Expandability: The HP 250 has growth potential in storage, workstations, and printers, with modular expansion that matches growing business needs.

Data Base Management: To manage complicated interrelationships between information elements, IMAGE/250 offers advanced features over traditional file management.

Dependability: The HP 250 provides reliable, worry-free operation backed by a strong, worldwide support organization.

HP 250/30 System

from \$22,500

*Softkeys are unique to HP computer products.



HP300

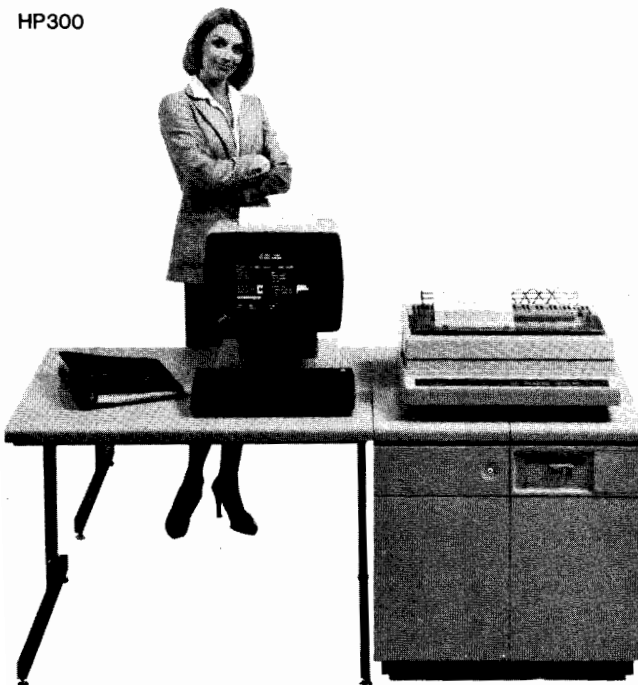

HP250/30

COMPUTERS, PERIPHERALS & CALCULATORS

Interactive Display Terminals

Models 2382A, 2621A/P



2382A



2621P

Introduction

Hewlett-Packard's family of interactive terminals feature a wide range of capabilities which are optimized to suit a variety of applications on HP computer systems and software packages. These applications include program development, data entry, document preparation and graphics.

The new HP 2382A Office Display Terminal is a block/forms mode display terminal for office use. The 2382A consumes less than a cubic foot of space, which makes it ideal for the office desktop, yet provides many of the high performance features available in larger HP terminals. Non-computer professionals and infrequent computer users, such as managers, will find the 2382A's small size, simple styling and easy to use features the correct solution to their data processing needs.

The HP 2620 family of interactive terminal range from the simplicity of the character mode 2621A/P, with its two pages of display memory, to the sophistication of the 2626A which provides multiple user defined workspaces and windowing plus a multipoint data communications capability. The newest additions to the 2620 family are the 2622A low cost block mode terminal and the 2623A low cost graphics terminal. The 2622 adds a block/forms mode capability to the 2621A/P while the 2623A provides the 2620 family with a graphics capability and supports all the features of the 2622A. The 2620 series features the convenience of built-in hardcopy across the entire line including graphics hardcopy on the 2623A.

The HP 2640 series of interactive terminals support many of the features and applications that are supported with our 2620 family. The important distinction is that local mass storage is available with the 2640 family. In addition more standalone operations; such as document preparation (HP 2642A), local programmability in BASIC and graphics software (HP 2647A) for preparing graphics and slides local are available.

Terminals which are designed for OEM's are available in both the 2620 series (HP 2629 family) and the 2640 series (2649 family).

2382A Office Display Terminal

- Small Size
Requires less than 1 cubic foot of space
- High Resolution Display
- 80 Column x 24 lines
- Two pages of display memory
- Four display enhancements
- Block/Forms Mode
- Screen Labeled Softkeys
- Detached Keyboard

The 2382A Office Display features an 80 column by 24 line high resolution display, two pages of display memory, an optional line drawing character set, and four display enhancements including inverse video, half bright, underline and blinking. Screen labeled softkeys allow an application programmer to customize the keyboard to perform several operations with a single keystroke. The detached typewriter style keyboard is familiar and easy to use. The light weight and small size of the 2382A allows it to be positioned where the operator desires so as to minimize operator fatigue. Also the sculptured keycaps and cursor control keys make the operator's job easier.

2621A/P Interactive Display Terminal

- High resolution display
- Two full pages of memory
- Built-in hardcopy
- Modify mode

The 2621A/P displays 1920 characters in a 24 line by 80 column format and contains two full pages of memory for a backward look at interactive dialogue. Local hardcopy is provided by an optional built-in printer and Modify Mode allows an operator to edit and then transmit any selected line from the terminals 48 line display memory.

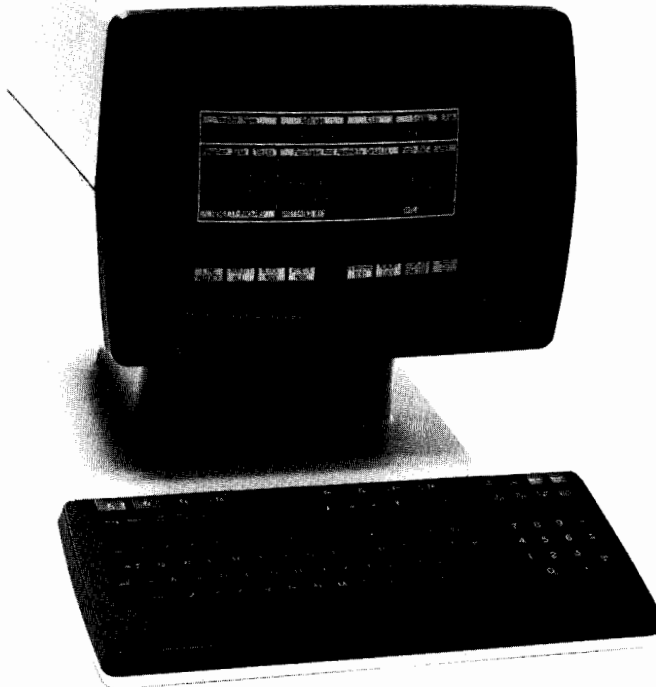

2622A

2622A Display Terminal

- High Resolution Display
7 x 11 dot matrix, 9 x 15 character cell
- Block/Forms Mode
- User Defined function keys,
screen labeled
- Six National Character Sets (optional)
- Built-in Thermal Printer (optional)

The HP 2622A has been designed to fit data entry needs. Two pages of display memory, the optional line drawing set, and four display enhancements enable the HP 2622A to be tailored to meet data entry form requirements. The display enhancements which include inverse video, half bright, underline and blinking in all combinations, can be used to depict an existing paper form and to facilitate data entry. A familiar and clear form provides ready acceptance by previous users and accelerates training of new operators. For the programmer, the HP 2622A has several advanced features that increase user productivity. The two pages of display memory allow the programmer to scroll or page through 48 lines of code. Information can be logged to an internal printer before it rolls out of memory. The printer can copy a line, page, or the entire display memory in either an 80 or 132 column format.

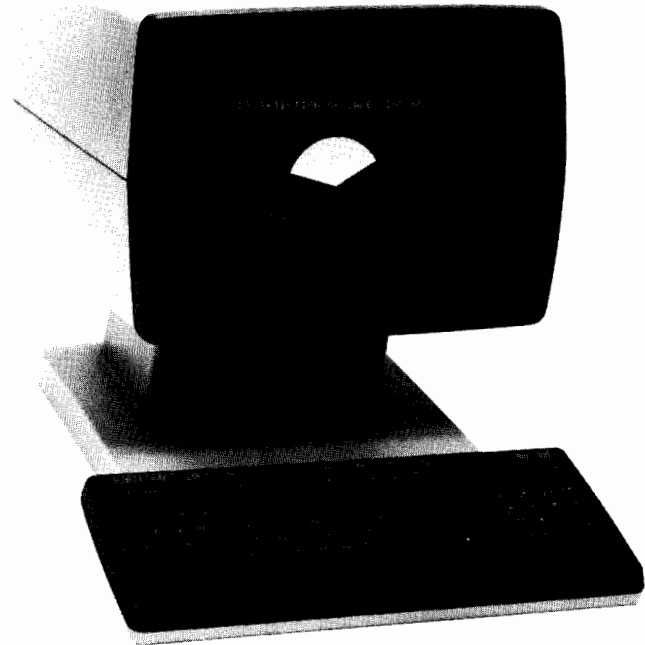

2623A

2623A Graphics Terminal

- High Quality Display
512 x 390 dot resolution
TEKTRONIX® 4010 compatible (1024 x 780 dot resolution)
- Built-in Graphics Hardcopy
- Fast Vector Generation
9600 baud throughout
- Graphics Text Composition in US ASC II, and Six National Languages
- 2622A Compatible

The low cost 2623A is designed for the graphics user with an extensive on-line capability and system based software. The high quality display features 512 x 390 dot screen resolution and is ideally suited for many display graphics applications as well as some design applications. A built-in printer provides low cost graphic hardcopy in only 30 seconds by simply pressing a key.

The 2623A is supported on HP's Graphics 1000/II and Decision Support Graphics Software. The 2623A also works with other third party software such as TEKTRONIX®'s Plot 10 and is compatible with the TEKTRONIX® 4010 display terminal.

The 2623A can generate vectors at 9600 baud and graphs can be quickly annotated locally in ASCII, or six other optionally available national languages, before obtaining a hardcopy.

All of the alphanumeric capabilities of the low cost block mode 2622A are available in the 2623A.

®TEKTRONIX is a registered trademark of Tektronix Corporation.

670



COMPUTERS, PERIPHERALS & CALCULATORS

Interactive Display Terminals

Models 2624B, 2626A



2624B

2624B Display Terminal

- High Resolution Display
- Multiple Forms Storage
- Advanced Forms Mode
- Multipoint
- Printer By-pass, in Multipoint

The 2624B represents the ultimate in a data entry terminal. Multipoint forms can be downloaded from the system and stored in display memory for instant retrieval. This reduces the burden on the system and improves system response time while lowering transmission costs. The advanced edit checks which are supported by the HP 2624B improve data integrity and increase data throughput. In addition to protected, unprotected and transmit only fields the 2624B provides the first level of data verification through field edit checks. The edit checks allow the terminal to detect many data entry errors and notify the user. By correcting errors at the terminal, system overhead is reduced. The checks include all characters, alphabetic, alphanumeric, numeric, integer, signed decimal and implied decimal. The preprocessing capabilities are justify, fills and implied decimal. Required and total fill fields provide entry control. These capabilities are an asset to applications that do not do data checking today and they reduce system overhead in programs where the computer previously performed all of the data verification.

The 2624B provides comprehensive point-to-point communications as well as multipoint communication so that multiple terminals can share an expensive communications line. The 2624B built-in printer can operate in printer by-pass mode in multipoint. That is, the printer can be designated as a destination device and information can be sent directly from data comm. to the printer without disturbing the information on the screen or tying up the terminal display.



2626A

2626A Display Station

- Multiple Workspaces
- Multiple Windows
- Dual Data Communications Ports
- Multipoint Data Communications
- Interactive Forms Design

The 2626A is a high performance terminal which provides unique display capabilities and data communications flexibility. The 2626 display memory can be divided into four independent workspaces, and the display screen into separate windows to examine and manipulate the contents of the workspace. Dual data communications ports can be linked to workspaces to display data from two different computers. An optional integral printer provides copies of forms and up to 132 column reports on 8½ inch wide paper.

Display memory may be divided into a maximum of four individual workspaces. Each workspace may be independently viewed, controlled and configured including attachment to a data comm port. (For example memory lock, auto line feed, etc., may be set in a particular workspace.) Data may be transferred from one workspace to another to the integral printer or to an external device. This capability amounts to four virtual terminals which may be changed from application to application or system to system.

The number of lines in a workspace may vary; however, the total number of lines in all workspaces must be less than or equal to the total amount of memory available. The total amount of memory available is 9520 displayed characters independent of control codes for display enhancements, field definitions, and edits. The line length for all workspaces may be set from 80 to 160 characters so that 132 column reports as well as double width pages may be handled. Viewing is via horizontal scrolling.

Two communications ports allow simultaneous communications with two computers or with a computer and external RS232 serial printer. Data may be communicated to the computer using block, line, line modify, or character modes in point-to-point or multipoint.

The 2626A is ideally suited for program development or data entry particularly when taking advantage of the easy to use function key approach to forms design.



2647A

2647A Intelligent Graphics Terminal

- Programmable in BASIC
- Multiple Automatic Plotting
- Shared Peripheral Interface
- Integrated Mass Storage

The 2647 is the intelligent solution to a host of applications that require both an on-line capability and local programmability. The 2647A is user programmable in BASIC, and offers a number of menu driven application programs that generate slides and charts. The 2647A features a raster scan display and a full interactive alphanumeric capability.

The 2647A offers sophisticated local graphing capability while requiring little or no programming knowledge of the user. Menu driven, the 2647A can plot columnar data in multiple formats chosen by the user. Pie charts, bar charts and X-Y Cartesian and logarithmic graphs can all be created without any host CPU graphics software. Different types of shading patterns are available for highlighting the various charts. Data may be submitted to the 2647A from one of three sources; host computer, tape cartridge or display memory. One simply fills in the blanks on a menu form which appears on the terminal screen. Once the data parameters are defined, the data can then be plotted with a single keystroke. This powerful feature makes graphs friendly, easy to create, and system software independent.

The 2647A contains all of the above features in addition to the capabilities of Hewlett-Packard's first graphics terminal, the 2648A.

2648A Graphics Terminal

- Integrated Mass Storage (optional)
- Automatic Plotting

The 2648A is a lower cost alternative to the 2647A. The 2648A provides less standalone capability.

2642A Display Station

- Minifloppy Mass Storage
- Text Preparation Mode
- Forms Design Mode
- Shared Peripheral Interface

The 2642A is a sophisticated and flexible terminal providing substantial offline capabilities. The 2642A retains most of the features of the 2645A; high resolution display; user-defined soft keys; flexible data communications; modular architecture and hard copy interface. In addition the 2642A adds five other major features to the Hewlett-Packard 264X Alphanumeric Product Family: Flexible Mini Disc Drive Support; Forms Design Mode; Text Preparation Mode; Screen Labeled Softkeys/Command Channel and Shared Peripheral Interfaces.

2645A Alphanumeric Display Station

- Integrated Mass Storage
- Forms Mode
- Choice of Communications Capability

The 2645A is a high performance alphanumeric display station that can operate at speeds up to 9600 baud in a fully interactive character-by-character mode or in a variable length block mode. Features such as a high resolution display, forms mode, full editing capability, fully integrated mass storage provided by cartridge tapes, user-defined soft keys, flexible choice of data communications, modular architecture, microprocessor control and hard copy interface make the 2645A the perfect solution for many computer applications.

Display Terminal Application Chart

Display Terminal	Program Development	Data Entry	Document Preparation	Graphics
2382A	○	●	○	
2621A/P	●	○	○	
2622A	○	●	○	
2623A	○	●	○	●
2624A	○	●	○	
2626A	●	○	○	
2642A	●	○	●	
2645A	●	○	○	
2647A	○	○	○	○
2648A	●	○	○	○

○ = Compatible Terminal with 3000 Software
● = Recommended Terminal with 3000 Software

Ordering Information

	Price
2382A Office Display Terminal	\$1700
2621A Interactive Display Terminal	\$1595
2621P Interactive Display Terminal	\$2750
2622A Display Terminal	\$2075
2623A Graphic Terminal	\$3750
2624B Display Terminal	\$2890
2626A Display Station	\$4150
2642A Display Terminal	\$6750
2645A Display Terminal	\$3955
2647A Intelligent Graphics Terminal	\$9400
2648A Graphic Terminal	\$6530

Opt 007* Integrated Dual Cartridge Tape Unit \$1400

Opt 050** Integral Printer \$1210

Opt 007* available with the 2645A and 2648A.

Opt 050** available with the 2622A, 2623A, 2624B, 2626A.

COMPUTERS, PERIPHERALS & CALCULATORS

DSN/Data Link

- Simple installation
- Up to 8 km (5 miles) long
- Multipoint block mode protocol
- Up to 128 devices per link (depending on the computer)

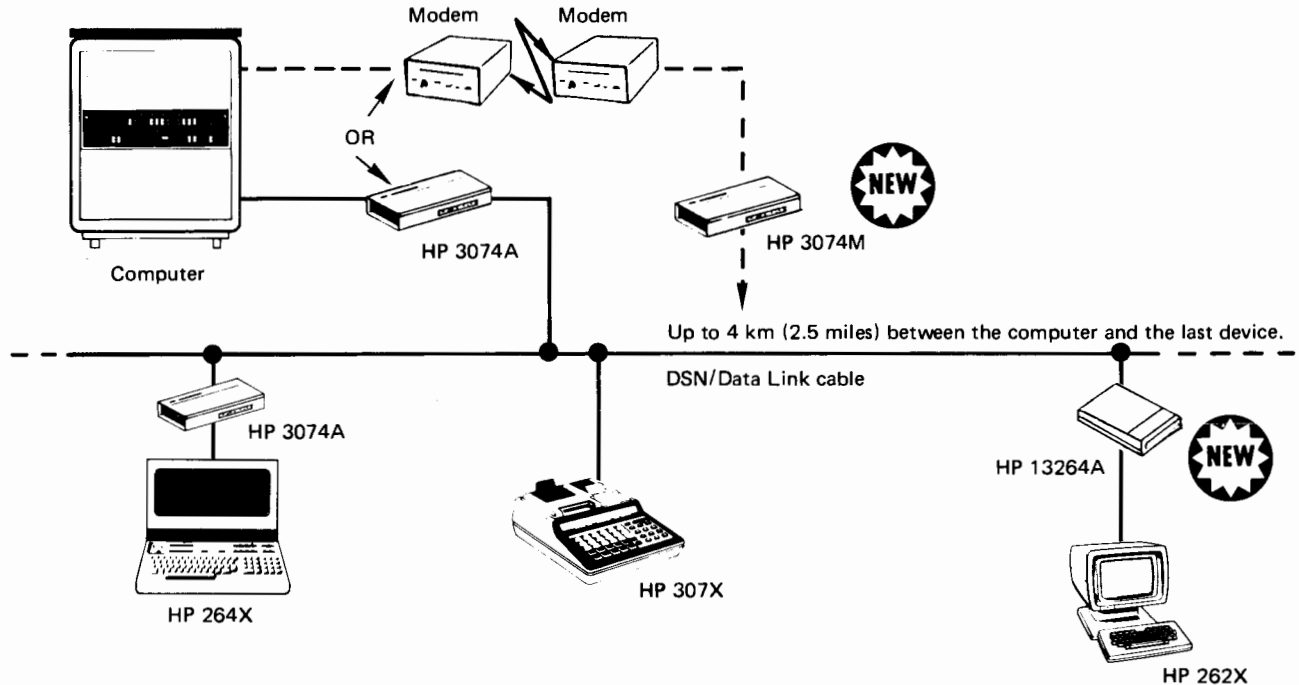

Introduction

The "DSN (Distributed Systems Network)/Data Link" provides a data communications interface between a computer and a large number of devices. It is a low cost system ideally suited for applications involving the collection of data from many widely distributed sources in the same building. The Data Link is compatible with any computer that uses RS232C data communications and supports the asynchronous multipoint block mode protocol (patterned after IBM's BISYNC). In addition the computer is always the Data Link controller, initiating all transfers to and from the devices.

The Data Link employs a single cable to provide the interface connection between the computer and the devices. The "link-dedicated" devices are directly connected to the cable. The computer and "non link-dedicated" devices are connected to the cable via Data Link Adapters. These adapters convert the device's RS232C electrical levels to those required by the cable.

A further feature of the Data Link is its immunity to extraneous electrical noise, allowing it to be used in industrial environments. This is achieved through the use of optical isolators and floating differential signal lines.

DSN/Data Link Cable

The Data Link cable comprises a single, low voltage computer cable consisting of a twisted pair (data wires) and shield that may be up to 8 km (5 miles) long. Up to 128 devices may be connected in parallel anywhere along the cable (depending on the computer), provided no device is more than 4 km (2.5 miles) from the computer.

The Data Link installation has been simplified through the use of Data Link Connection Boxes. These boxes are wired to the Data Link cable and enable the devices to be plugged into and unplugged from the Data Link as required. Consequently the installation can be easily changed or upgraded as required, thereby increasing its versatility. For further details, refer to the DSN/Data Link data sheet.

Data Link Adapters

The Data Link Adapters provide an interface between the computer/devices using multipoint protocol and the Data Link, converting

their RS232C electrical levels to those required by the link. They operate at the data transmission speed of the connected device, in the range from 110 to 9600 baud. The adapters (except the 3074M) provide power-on/off detection to ensure that when a device is switched off, it cannot generate spurious data onto the link. There are three available Data Link Adapters; the HP3074A, HP3074M and the HP13264A:

3074A Data Link Adapter: the 3074A may be used to provide a hardwired connection between equipment fitted with an RS232C data connector that uses RS232C electrical levels, and the Data Link. This allows the connection of any computer equipped with an RS232C interface and any CRT terminals, such as the HP 264X series. For further details, refer to the 3074A/M data sheet.

3074M Modem/Data Link Adapter: the 3074M may be used with asynchronous full duplex modems to provide a connection between a "remote" computer (using RS232C electrical levels) and the Data Link. It may not be used between a remote terminal and the Data Link.

13264A Data Link Adapter: the 13264A may be used to provide a hardwired connection between the Data Link and equipment using RS232C electrical levels but fitted with a non RS232C 50-pin connector, such as the HP 262X series of terminals. For further details, refer to the 13264A data sheet.

DSN/Data Link Compatible Equipment

The following Hewlett-Packard devices may be connected to the Data Link:

- 2624B and 2626A CRT terminals.
- 2642A, 2645A, 2647A and 2648A CRT terminals.
- 3075A, 3076A, 3077A and 3078A Data Capture Terminals.
- HP 1000 and HP 3000 computers.

Ordering Information

3074A Data Link Adapter		\$715
3074M Modem/Data Link Adapter		\$860
13264A Data Link Adapter		\$345
92902A Data Link Cable	100m	\$330
	300m	\$936



- Modular choice of displays, keyboards, readers, printer and electrical interfaces
- Versatile data acquisition and control

- User definable keys / prompting lights for ease of use
- Simple, low cost installation



The 307X Terminal Family

The HP3075A/3076A/3077A/3078A family of data capture terminals fulfills a wide range of data collection requirements in both manufacturing and commerce; in applications ranging from stock control to machine monitoring.

The HP3075A (desktop) and the HP3076A (wall mounted) terminals are both workstations equipped with user definable special function keys and prompting lights that may be individually labelled and programmed for specific tasks. This allows people with little or no experience of using computers to operate these terminals with no special training. The terminals may also be equipped with a choice of displays, readers, printer and electrical interfaces.

The HP3077A is a wall mounted time reporting station equipped with a time display and a badge/card reader. It may be used, for example, to register personnel arrivals and departures or to control access to restricted areas.

The HP3078A is a desk/wall mounted data coupler that complements the range of 307X Data Capture Terminals by adding a remote, automatic electrical data acquisition capability. The 3078A may be equipped with any three from a wide range of HP interface cards that allow it to be connected to a variety of instruments commonly used in manufacturing environments.

3075A, 3076A Specifications

The 3076A is a wall mounted version of the 3075A and is supplied with the HP92904A Wall Mounting Cradle as standard. The other specifications for the 3075A and 3076A are identical.

Standard terminal: this includes:

- Standard numeric keyboard.
- Standard numeric display.

Terminal options: these include:

- Alphanumeric keyboard (option 004).
- Alphanumeric display (option 005).
- CRT display (option 006).
- Multifunction reader (option 007).
- Type V badge reader (option 008).
- Strip printer (option 009).
- HP low cost bar code reader (option 010).
- HP-IB controller (option 011).
- Magnetic stripe reader (option 012).
- Serial (RS232C) interface (option 013).
- Industrial low resolution bar code reader (option 054).
- Industrial high resolution bar code reader (option 055).

The terminals are compatible with RS232C communications and may be connected to the computer using any one of the following three modes:

- 1) DSN/Data Link.
- 2) Multipoint.
- 3) Point-to-point.

3077A Specifications

The 3077A is a wall mounted time reporting terminal and is supplied with the HP92904A Wall Mounting Cradle as standard. Its standard features include:

- Clock display.
- Type V badge reader.

Terminal options: these include:

- Multifunction reader (option 001).
- Magnetic stripe reader (option 002).
- Alphanumeric display (option 005).

The 3077A may be connected to the computer in a similar manner to the 3075A and 3076A. For further details, refer to the 3075A/3076A/3077A data sheet.

92904A Specifications

The 92904A holds one 3076A or 3077A terminal on a wall and routes the electric power and data cables to the terminal. It also contains a relay that may be used to control an external device, e.g. electric door lock.

3078A Specifications

The 3078A Data Coupler is an automatic data capture terminal (i.e. it does not require an operator) that may be mounted on a desk or a wall. It may be equipped with any three of the following interface cards in any combination:

- BCD input card.
- 8 bit parallel I/O card.
- HP-IB controller card.
- 4 channel serial I/O card.
- 8 channel logic and event sense card.

These cards allow each 3078A to control a variety of user devices. They provide electrical interfacing capabilities in applications such as:

- Machine monitoring.
- Automated production line testing.
- Remote interfacing to various user measuring instruments; e.g. scales.

The cards interface the user equipment to the computer. They are designed to comply with existing standards (e.g. IEEE 488-1978 for the HP-IB card). When no standard is available, they may be configured by the program to match the interfacing requirements of the connected device. In addition, the use of simple screw connectors for cabling allows them to be easily connected to various types of instruments. This combination of interfacing capabilities makes the 3078A a highly versatile tool for adapting to a particular requirement.

The 3078A must be connected to the computer via the DSN/Data Link. This allows the data to be collected at distances up to 4 km (2.5 miles) from the computer.

For further details on the cards' specifications, refer to the 3078A Data Coupler data sheet.

Ordering Information

	Price
3075A Desktop Data Capture Terminal	\$2710 to \$5980
3076A Wall Mounted Data Capture Terminal	\$3195 to \$6465
3077A Wall Mounted Time Reporting Terminal	\$3605 to \$4700
92904A Wall Mounting Cradle	\$505
3078A Data Coupler	\$2525 to \$5688



COMPUTERS, PERIPHERALS & CALCULATORS

Technical Computer Peripherals

Models 82901M, 9895A

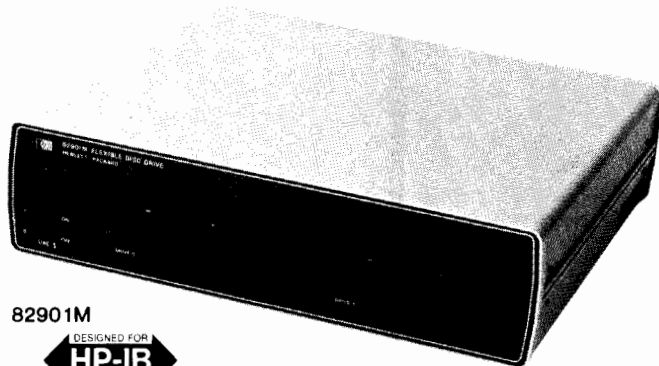

82901M



Flexible Disc Drives

When you handle large amounts of information, you need the speed and storage capacity of disc drives to perform timely, meaningful analysis.

The flexible disc drive is the low-cost, entry-level device in the HP Mass Storage Family.

Flexible disc drives combine the speed of random access with removable media. You can take your programs and data with you and simply store them in your desk. So if you share your computer system with a lot of people, you can maintain control over your own data to use when you want.

And flexible disc drives use low-cost media. Typically much less than the cost of today's tape cartridges.

Plus the flexible disc drive gives you vital backup capability in the same unit so you can easily copy discs without the expense of any additional backup device.

HP Qualified Media

HP provides a convenient source of approved, qualified media through extensive testing, selection and control. HP's qualified selection not only assures the best, most reliable performance in HP disc drives, but can also give you at least three times the media life as well.

Your Choice Among Family

You can choose from among a family of HP Flexible Disc Drives, designed to match the power of HP's wide range of computers and your varying application needs.

HP computers support the HP Family of Flexible Disc Drives with easy-to-use Mass Storage Language statements and a file-by-name system directory.

82901M

The HP 82901M is a 5¼" flexible disc dual-drive which supplies up to 540K bytes of fast, reliable, random access storage. Each of the two drives in the 82901M reads and writes double-sided, double-density format on HP-qualified flexible discs. Each disc provides 270K bytes of formatted storage.

The 82901M's average access speed of less than two-tenths of a second and 540K byte capacity are excellent for programs such as VisiCalc®, Information Management and Graphics Pacs whose high-performance calls for fast and reliable on-line access to large amounts of data.

If your present applications do not require large storage at this time, a single-drive master, the 82902M, is also available supplying 270K bytes of information.

Features

- Increased Capacity
Double-Sided, double-density, 270K bytes/disc
- Fast Performance
Less than two-tenths of a second access to any file
- High Reliability
Extensive hardware and electronic testing to maintain less than 1 error in 10⁸ bits

Ordering Information

82901M Dual-Drive Master	\$2500
82902M Single-Drive Master	\$1500
92190A 5¼" Double-Sided Media (10/box)	\$74

VisiCalc® is a trademark of Personal Software, Inc.

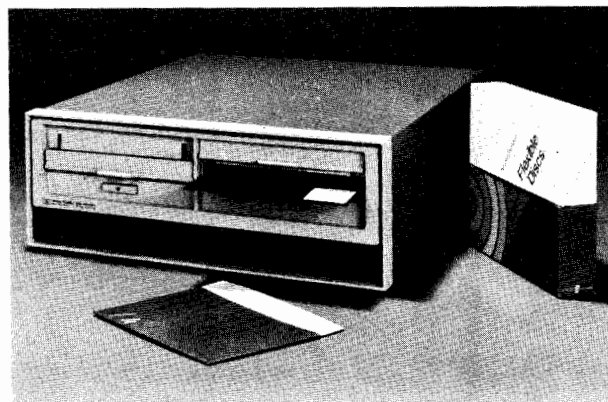

9895A



9895A

The Hewlett-Packard 9895A Flexible Disc Memory provides up to 2.36 million bytes of mass storage capacity. Each of the two drives in the 9895 reads and writes double-sided, double-density format on HP qualified flexible discs. The 9895 can store up to 590,000 bytes of data per disc side for a total of 1.18 million bytes of storage per disc.

Featuring the HP-IB interface, the 9895 is compatible with the majority of HP computer systems including personal, desktops*, business and mini-computers.

The 9895's built-in controller can recognize if the flexible disc has been recorded on one or two sides. This capability enables the 9895 to read single-sided discs written by the HP 9885M/S Flexible Disc Memories. The controller of the 9895 also allows it to exchange data with other systems which use the IBM 3740 single-sided, single-density format provided additional software exists on the host computer. (Note: Since tolerance on IBM compatible media are not fully specified by vendors and do vary, HP cannot guarantee that IBM 3740 media can be read by the 9895 in every case.)

The 9895 can provide up to 4.72 million bytes storage capacity through an optional dual-drive slave unit (without controller). This option is one of several available designed to give the user price-performance flexibility. An optional single-drive slave offers an extra 1.18 million bytes storage, and the dual-drive slave provides an additional 2.36 million bytes. The 9895 can also be ordered with one drive installed for 1.18 million bytes capacity. These options can be easily upgraded to 9895 full capability at a later date if the user so desires.

*The 9835 and 9845 Desktop Computers require a dedicated HP-IB channel (98034A) for mass storage devices.

Features

- Double-Sided/double-density
- HP-IB Compatible
- Handles up to four drives
- Reads and writes 9885 single-sided discs
- Optional slave storage
- Single drive option

Ordering Information

9895A Dual drive with controller	\$6830
9895A Opt. 010 Single drive with controller	\$4990
9895A Opt. 011 Single drive with controller	\$3940
9895A Opt. 012 Dual-drive slave without controller	\$5780
92195A 8" double-sided media (10/bx)	\$105
9895A Opt. 145 (includes 9845 IBM Format Utility)	\$7355
09845-10740 (9845 IBM Format Utility alone)	\$525
9895A Opt. 135 (includes 9835 IBM Format Utility)	\$7355
09835A-15230 (9835 IBM Format Utility alone)	\$525
9895A Opt. 185 (includes Series 80 Data Exchange Utility)	\$6925
88095A (Series 80 Data Exchange Utility alone)	\$95

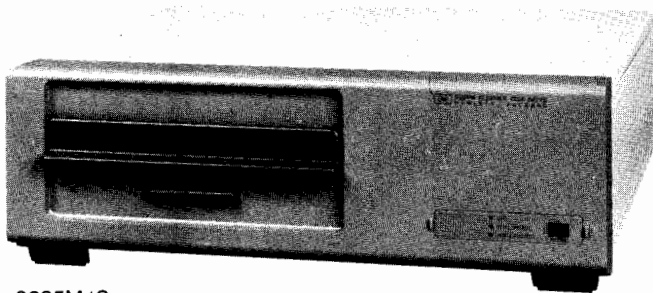

9885M/S

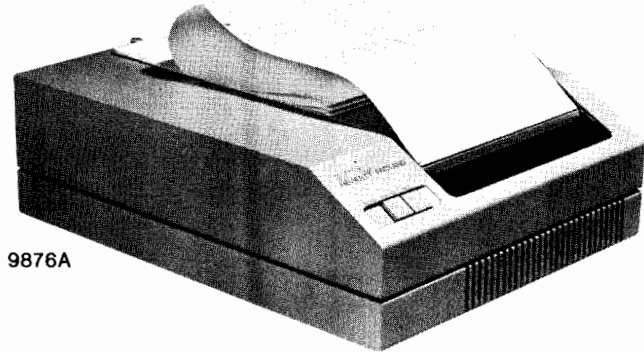

9876A



9885M/S

Low cost, high speed, large storage capacity, reliability and ease of operation in data management are features offered by the 9885 Flexible Disc Drive. The 9885 provides a means of transferring data and programs to and from the 9825, 9835 and 9845 Desktop Computers as well as the HP 1000 M, E & F Series. Mass storage on the 9885 provides random access to approximately 500,000 bytes of data per removable disc.

This reliable and easy-to-use flexible disc drive comes in two versions: the 9885M (master) and the 9885S (slave). The 9885M contains a built-in controller to handle data storage for the master and up to three additional drives. Up to three slaves can connect to one master. This expandability provides a means of ensuring easy "backup" of critical information or providing random access to nearly two million bytes of data. The 9885S has no controller and must be connected to the 9885M.

Average transfer rate between computer and disc drive is 23K byte/s. Double-density read/write on the flexible disc further enhances access rate and increases total storage capacity. Average access time on the disc is 267 ms. The 9885 is also self-contained and incorporates a self-test feature.

Features

- High speed data transfer
- Double-density read/write
- Write verify for greater reliability
- Self-contained package
- Approximately 500,000 bytes of total user-available space per disc
- Low-cost, removable disc
- Multiple flexible disc drive configuration
- Data recovery routines

Ordering Information

9885M Flexible Disc Drive Master	\$3500
9885M and Opt. 025* (for operation with 9825B/T)	\$4000
9885M and Opt. 035* (for operation with 9835)	\$4000
9885M and Opt. 045* (for operation with 9845)	\$4000
9885S Flexible Disc Drive Slave	\$2750
9164-0105 8" Single-Sided (10/bx)	\$89

*Mass memory ROM Not included.

9876A Thermal Graphics Printer

The 9876A Thermal Graphics Printer is a fast, quiet line printer offering graphics capability as well as alphanumeric printing. Its speed of up to 480 lines per minute makes it ideal for producing high-

speed listings, working reports or quick plots and graphics. The 9876 is quiet enough for lab or office, and reliable enough to run unattended.

The raster graphics field contains 560 dots across an 18.5 cm field. The standard ASCII character set is in a 5 x 7 dot matrix format with additional dots available for ascenders and descenders, underlines and overlines. The additional dots (in a 7 x 12 matrix) can be used to define any special characters you may need for unique applications. Underlines, overlines and characters 50% taller than normal let you highlight elements of the output to make it more legible. Seven international character sets—French, German, Katakana, British, Spanish, Danish/Norwegian and Swedish/Finnish—reside in the printer and can be accessed by software.

The 9876 thermal paper comes in fanfolded, perforated, standard size packages of 330 sheets, either 8.5 x 11 in. (216 x 279 mm) English size or 210 x 297 mm (8.27 x 11.69 in.) metric size. The paper is available for printing either in blue for utility use or in black for high contrasts and fade resistance.

Built-in self-test features assure proper operation or help pinpoint problems quickly to maintain the 9876's reliable performance.

Available with HP-IB (IEEE-488), 8-bit parallel or RS-232-C interfaces, the 9876 is compatible with a wide variety of computers and terminals from Hewlett-Packard and other manufacturers.

The 9876 is also available as a caseless version (11479).

Features

- Fast printing and graphics
- Quiet operation
- Easy to read hard copy output
- Character generation flexibility
- Nine software selectable character sets
- Form control functions
- English and metric perforated, fanfolded paper
- 30 dot/cm (77 dot/in.) graphics resolution

9878A I/O Expander—interfaced with the Hewlett-Packard 9825, 9835 and 9845 Desktop Computers, provides six additional I/O ports and will accommodate all the 9825, 9835 and 9845 interface cards.

Ordering Information

9876A Thermal Graphics Printer	\$4725
Caseless Version	\$4465
9878A I/O Expander	\$1700

COMPUTERS, PERIPHERALS & CALCULATORS

Printers/Printing Terminals

Models 2671A, 2671G, 2673A

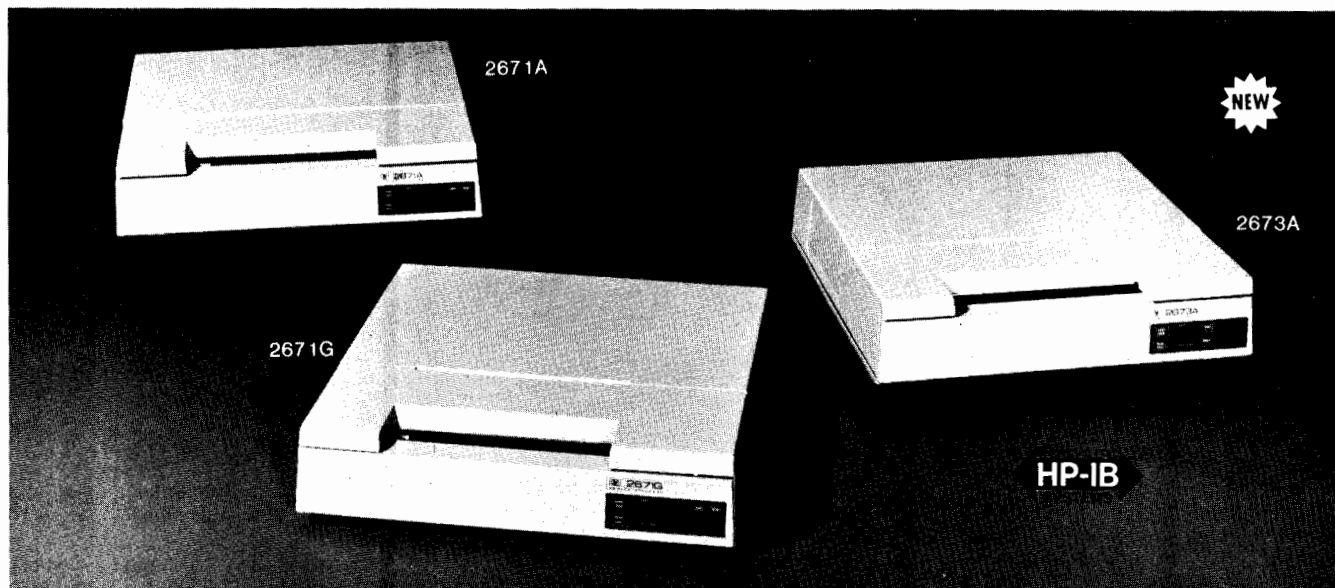

2670 Series Printers

All three printers feature fast 120 character per second bidirectional printing, a 9 x 15 dot matrix character cell and true descenders for character sharpness, quiet operation, and interface flexibility for a wide range of applications. Flat, fanfold paper eliminates the curl problem normally associated with roll paper.

The 2671A Printer:

The entry level printer for text printing. The 2671A features the full 128 USASCII character set, Roman Extension characters for international use, and Line Drawing characters to create forms. Print modes are normal (10 cpi) and compressed (16.2 cpi). Compressed mode allows up to 132 characters to be printed on a line.

Margins, print mode, primary/secondary character sets, and an underlining character enhancement are selected through simple escape sequences transmitted from the host device. A convenient front panel contains form feed, paper feed, self test, and printer reset buttons.

The 2671G Graphics Printer:

Clean text printing and dot-for-dot graphics copies. The 2671G offers all the features of the 2671A plus high resolution graphics printing of charts, tables, illustrations, graphs, etc. Single keystrokes or convenient binary drivers control the transfer of graphics from HP raster devices to the 2671G. Software routines can be written to copy dot-addressable graphics from non-HP devices.

The 2673A Intelligent Graphics Printer:

Sophisticated graphics, full format text printing, and easy-to-use non-volatile configuration. The 2673A offers all the capabilities of the 2671A and 2671G plus many additional user-convenience fea-

tures. Enhanced graphics capabilities include auto-centering, windowing, and offsets. Margins, tabs, print mode, character sets, page format, and datacomm parameters are selected via an expanded control panel and stored in the printer's non-volatile memory. Once selected, these features come up automatically at printer power-on.

Print modes include expanded (5 cpi) in addition to normal and compressed. Enhancements include triple-pass printing, underlining, and character framing. The 2673A features 9 7-bit ISO national character sets in addition to Roman Extension and Line Drawing character sets.

Application Flexibility: The versatile HP-IB (IEEE-488) interface is standard with all three printers. RS-232C serial and both HP and Centronics-compatible parallel interface options provide convenient interfacing to a broad range of products and systems.

The 2671A is ideal for applications requiring fast, quiet text printing: desktop and personal computers, development stations, and character mode terminals.

The 2671G and 2673A provide cost effective solutions for diverse applications that require both text printing and precise graphics copy: desktop and personal computers, graphics terminals, minicomputers, small office and business systems, development stations, and test and measurement systems.

Ordering Information

2671A Printer	\$1095
2671G Graphics Printer	\$1295
2673A Intelligent Graphics Printer	\$1895

COMPUTERS, PERIPHERALS & CALCULATORS



Printers/Printer Terminals

Models 2631B, 2635B, 2631G, 2631G #200

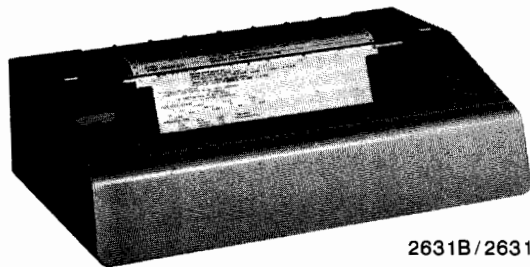

2631B/2631G

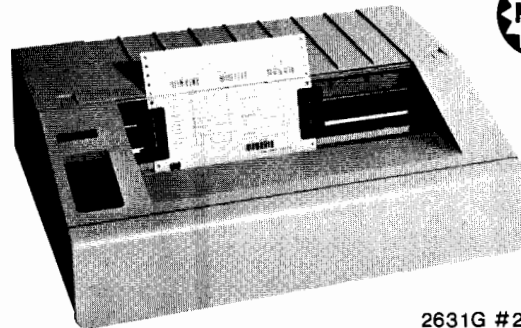

2631G #200

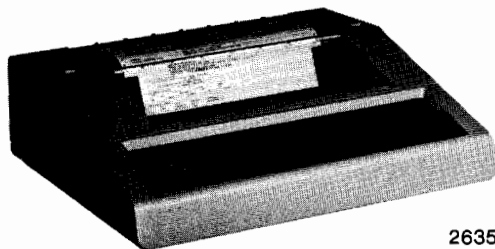

2635B



HP 2631B Printer

from \$3,900

The 2631B is a smart bidirectional dot matrix serial printer with a wide range of printing features to handle various printing requirements. The 2631B utilizes a 7 x 9 wire matrix print head for crisp, clear character formation at a speed of 180 cps. Multipart forms up to 6 parts can be printed. Form widths can range from 31mm (1.22") to 400mm (15.75").

Print Features: The 2631B offers versatile print features such as left and right margins, horizontal and vertical tabs, programmable page length, and twelve vertical line spacings. The 2631B also has eight different print modes including: normal (10 cpi), compressed (16.7 cpi), and expanded (5.0 cpi). Compressed print allows 132 columns to be printed on 8.5 inch wide paper, while other modes are useful for headings, titles, and bold print.

Character Sets: The standard character set is a full 128 USASCII set. For higher quality print, an optional 90 cps high density character set is available. National language character sets are available in both standard and high density. With any language option the 2631B provides access to standard and high density versions of the other national languages plus Roman Extension, Line Drawing, and Math Symbols character sets.

Variety of Interfaces: The 2631B has a variety of interfaces available for configuration on HP systems. These include RS-232C with full duplex modem control, ENQ/ACK, X-on/X-off, and printer busy protocols; 8-bit TTL interface for the HP 264X series of terminals; IEEE 488-1975 (HP-IB); and a parallel differential interface.

HP 2635B Printing Terminal

From \$4,300

The 2635B combines the printing features and capabilities of the 2631B with a typewriter-style keyboard for use in a variety of applications as a hardcopy printing terminal.

Configuration Keys: To facilitate use of the printing features available, the 2635B has a set of 12 configuration keys which allow the user to set parameters with only a few simple keystrokes.

Print Features: The 2635B utilizes the same print features which are available in the 2631B. These include left and right margins, horizontal and vertical tabs, programmable page length, eight print modes,

and twelve vertical line spacings. The 2635B output can be easily customized to handle different print requirements.

National Keyboards: The HP 2635B can be ordered with any one of six national keyboard options: Swedish/Finnish, Norwegian/Danish, French, German, United Kingdom, or Spanish. Each option provides keycap placements and character sets familiar to the national user, making the HP 2635B well-suited for interactive text printing, forms completion, and data entry.

Character Sets: USASCII, Roman Extension, Line Draw, Math Symbols, and six national languages are all standard character sets on the 2635B. For higher quality print, a high density version of each character set can be accessed. To insure compatibility with most computer systems, both 7-bit and 8-bit versions of each character set are provided.

Interfacing: The 2635B interfaces to asynchronous ports via an RS-232C interface. ENQ/ACK, X-on/X-off, and printer busy protocols are all available on the interface as standard protocols.

HP 2631G Graphics Printer

from \$4,900

The 2631G combines the capabilities of a high performance alphanumeric character printer with the ability to print raster data format graphics.

Graphics Printing: The 2631G offers 72 dot per inch vertical and horizontal resolution graphics printing, ideal for medium resolution graphics such as business, general scientific, and engineering data. As the hardcopy output device for the HP 2647A and HP 2648A Graphics Terminals, the 2631G prints a 10 by 5 inch copy of the CRT memory in 65 seconds.

Alphanumeric Printing: In alphanumeric printing, the 2631G shares many of the print capabilities of the 2631B. It is a smart bidirectional 180 cps serial printer with a 7 x 9 dot matrix cell, four print modes, seven line spacings, and optional high density USASCII print.

Bar Code and Mark Sense Printing: The Factory Data Printer (HP 2631G #200) provides automatic bar code printing, mark sense card printing, and forms generation capability. Three of the most commonly used bar code types are resident in the Factory Data Printer: CODE 39 alphanumeric bar code*, Industrial 2 of 5, and Matrix 2 of 5. In addition to these, user-defined codes may be generated with application programs.

*CODE 39 is a trademark of Interface Mechanisms, Inc.

Interfacing: The 2631G has an HP-IB (IEEE 488-1975) interface, which is compatible with the HP 2647A and HP 2648A Graphics Terminals, the HP 9845B, and the HP 9835B Desktop Computers.



COMPUTERS, PERIPHERALS & CALCULATORS

MAC Disc Drive Family

Models 7906, 7925

- Performance
- Reliability
- Serviceability

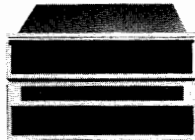

7906MR/SR

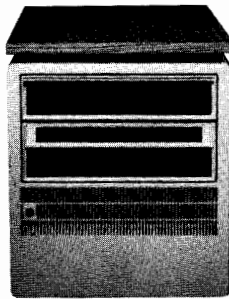

7906M/S

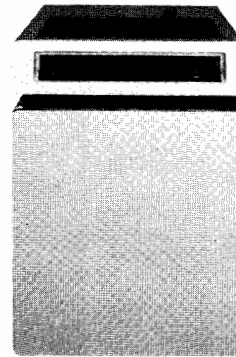

7925M/S

The Hewlett-Packard Multi-Access Controller (MAC) Disc Drive family offers a wide range of reliable, high-performance mass storage capabilities. Engineering and manufacturing excellence have been emphasized in the HP tradition to insure that the entire disc drive family exhibits the performance, reliability, and serviceability that have established HP products as a marketplace standard.

Features

- Configuration flexibility from 20 Mbytes to 960 Mbytes of HP-formatted usable storage
- High-performance disc drives, 25 ms average seek times
- Sophisticated microprocessor-based disc controller
- Systems engineered for optimum performance with HP computing systems
- Designed and manufactured for exceptional performance and reliability over a wide range of environments
- World-wide service and support

Description

Hewlett-Packard offers a complete line of controller-compatible disc drives for the minicomputer industry. The Multi-Access Controller (MAC) Disc Drive family is comprised of two high-performance disc drives: the 120-Mbyte 7925, and the 20-Mbyte 7906. These mass storage devices have been engineered and manufactured for reliability, performance and low cost of ownership.

The heart of the MAC Disc Drive family is a powerful Multi-Access Controller. Microprocessor-based architecture allows implementation of many sophisticated system features including access to as many as eight disc drives, extensive error correction, multi-CPU access, and automatic alternate track switching to name a few. Plug-to-plug compatibility across the entire family of disc drives permits up to eight 7906 or 7925 disc drives, in any combination, to be connected to a single controller. These features allow unmatched flexibility in configuring disc-based systems from 20 megabytes to 960 megabytes of HP-formatted user storage capacity.

7906 Cartridge Type Disc Drive

19.6 Mbytes formatted capacity: The 7906 disc drive features 9.8 Mbytes of removable and 9.8 Mbytes of fixed media to provide single-drive users with a convenient backup capability. The cartridge type media is exceptionally easy to store, use, and/or transport. An ad-

vanced temperature compensation circuit in each disc drive provides start-up times of less than 60 seconds and allows accurate transfer of data between the fixed and removable surfaces under diverse temperature conditions.

7925 Pack Type Disc Drive

120 Mbytes formatted capacity: Each 7925 removable pack type drive provides 120 Mbytes of formatted storage capacity, which means a total of 960 Mbytes (0.960 gigabytes) would be available using eight 7925 drives on a single Multi-Access Controller.

Configuration

MAC—The maximum configuration for MAC Family disc drives is eight 7906 and/or 7925 drives per controller. All cabling between Master and Slave drives is included.

Electromagnetic Emissions/Safety

Meets or exceeds EMC/RFI emissions standards such as VDE 0871 and C.I.S.P.R. Consult the appropriate HP systems configuration guide for details.

Products have appropriate UL/CSA approvals. VDE certification pending.

Performance Characteristics

Seek Time (All Models)

Track-to track: 5 ms

Average random: 25 ms

Full stroke (typical): 45 ms

Rotation

Speed: 7906 - 3,600 rpm

7925 - 2,700 rpm

Average latency: 7906 - 8.33 ms

7925 - 11.1 ms

Transfer Rates (Burst Only)

79XXM: 937.5 Kbytes/sec

79XXM-Opt 102: 0-1 Mbytes/sec

Ordering Information

79XXM Master Drive (includes Multi-Access Controller)

79XXS Slave Drive (Add-on disc drive with 79XXM)

7906XR Rack Mountable unit

Price

see table

Drive	Controller Included?	Max Power@ 120V, 60Hz	Media	Available Options	Base Price
7906M	Yes	740W/8.0A	12940A	015.102	\$16.000
7906MR	Yes	720W/7.8A	12940A	015.020.102	\$15.000
7906S	No	520W/5.7A	12940A	015	\$12.000
7906SR	No	500W/5.5A	12940A	015.020	\$11.000
7925M	Yes	630W/6.7A	13356A	015.102	\$22.050
7925S	No	410W/4.4A	13356A	001.015.250	\$17.850
7925T	No	410W/4.4A	13356A	001.015.250	\$31.450

Options:

001 Changes cable lengths. (Substitutes 5.5 m (18 ft.) Multi-Unit and 7.6 m (25 ft.) data cables for standard lengths)

015 230V/50Hz operation

020 Substitutes 30 inch rack slide kit

102 Adds HP-IB adapter kit

250 Adds controller upgrade service required to support the first 7925S added to our existing MAC subsystem (may include the use and/or exchange of refurbished printed circuit assemblies)

- Low Cost
- Reliability
- Serviceability

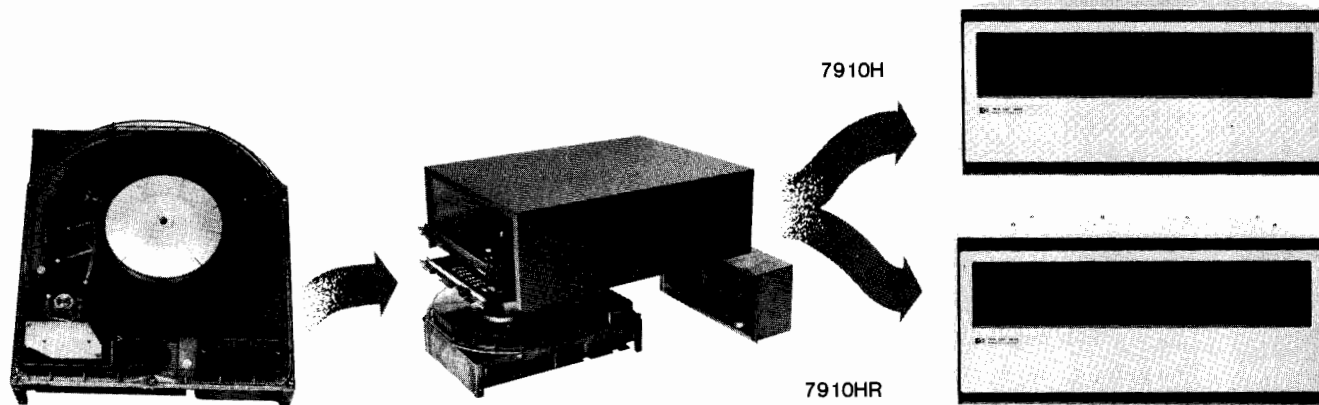

The 7910 disc drive is an ideal solution for applications requiring modest storage capacities and demanding lower cost.

Design features of the drive are totally unique from previous HP disc drives. The 7910 is the first Hewlett-Packard disc drive to feature both "Winchester" technology and fixed media. The mechanical simplicity afforded by this design is responsible for significant contributions to reliability and lower cost. The result is a low overall cost of ownership.

The 7910 provides 12 megabytes of formatted storage in a compact, lightweight package. The single disc platter in the 7910 is fixed within a sealed module providing operating independence from ambient conditions. The drive's servoing technique eliminates the need for field head alignment, and a comprehensive self-test diagnostic program contained in controller firmware improves serviceability. These features, combined with the drive's medium performance, make the 7910 ideal for a wide variety of applications.

The HP 7910 is especially suitable for small business systems operating in office environments, technical systems operating under harsh ambient conditions (laboratory or factory floor applications), or general purpose low cost systems requiring mass storage at a favorable price.

Winchester Technology

The head and media system in the 7910 employs "Winchester" technology. The Winchester head assembly is characterized by its low mass and light loading, exerting almost no "weight" on the read/write head as it "flies" over the surface of the disc media. Because Winchester disc media also has a thin film of lubricant deposited on its surfaces, limited head/media contact can occur during drive operation without damaging heads or media. Head crashes are virtually eliminated, significantly enhancing reliability.

Features

- Winchester head/media technology
- Mechanical simplicity offered by fixed media and a rotary actuator
- Embedded servo code
- Self-contained HP-IB controller capable of buffered and unbuffered data transfers
- Comprehensive internal self-test diagnostics
- Modular design for serviceability
- Environmental tolerance
- Lower entry level price and cost of ownership

RFI Emissions/Safety

Meets or exceeds EMC/RFI emission standards such as VDE 0871 and C.I.S.P.R. Consult the appropriate HP system configuration guide for details.

Products have appropriate UL/CSA approvals. VDE certification pending.

Specifications

Capacity

Formatted: 12.09 MB

Tracks per surface (2 surfaces)*: 735 + 3 spares

Sectors per track: 32

Bytes per sector: 256

*Up to 10 additional tracks per surface may be spared at the factory's option, and are not included in capacity figures.

Seek Time

Average track-to-track: 11 ms

Average random: 70 ms

Average full stroke (748 tracks): 100 ms

Rotation

Speed: 3,000 rpm

Average rotational delay (latency): 10 ms

Data Transfer Rates

Unbuffered burst: 526.5 kB/sec

Unbuffered average: 409.6 kB/sec

Buffered: System dependent

Temperature

Operating: 0° to 45°C (32° to 113°F)

Non-operating: -40°C to 65°C (-40° to 149°F)

Maximum rate of change: 10°C/hr (18°F/hr)

Maximum operating wet-bulb: 26°C (79°F)

Relative Humidity

Operating: 8% to 80%

Non-operating: 8% to 80%

Altitude

Maximum operating: 4 572 m (15,000 ft)

Maximum non-operating: 15 240 m (50,000 ft)

Power Requirements

100/120/220/240 Vac, +5% -10%, switch-selectable on rear panel, 47.5 to 66 Hz, single phase.

Ordering Information

7910H Disc Drive (desk-top)

7910HR Disc Drive (rack-mount)

Option 015 (230V/50 Hz operation)

Option 035 Utility Package for 9835 Desktop Computer

Option 045 Utility Package for 9845 Desktop Computer

Price

\$9,500

\$9,200

NC

\$105

\$105

The 7910H/HR drives are fully configured mass storage systems, ready for operation after simply being "plugged-in" to the host system. An HP-IB controller, power supply, cabling and packaging are standard in both models.

680



COMPUTERS, PERIPHERALS & CALCULATORS

Integrated Storage Product

Model 7908

- Integrated tape drive for backup and user I/O
- Internal self test and diagnostics
- Fixed disc reliability

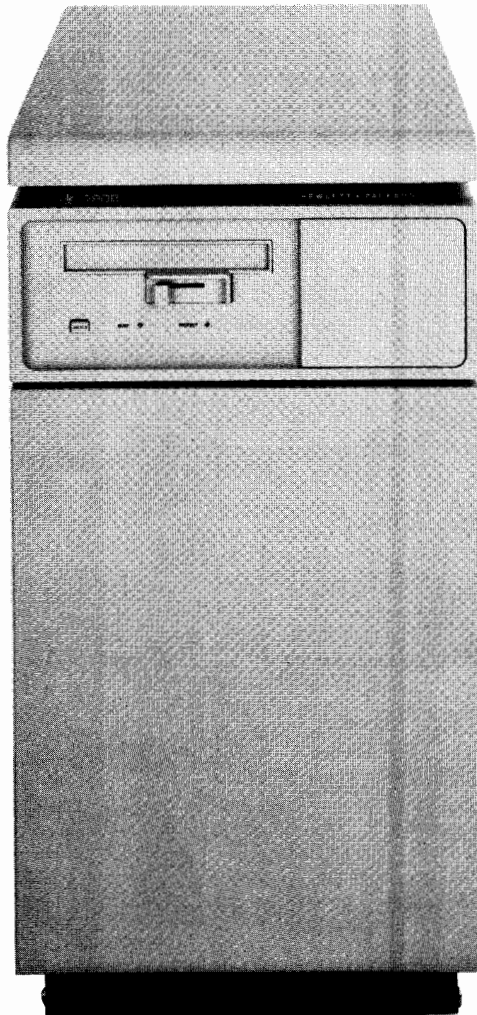

7908P

The 7908 Disc/Tape Drive is designed to satisfy all peripheral storage requirements in a single compact package. It utilizes a unique integrated storage concept, featuring a reliable Winchester disc mechanism for mass storage, and a 1/4 inch cartridge tape drive for backup and user I/O.

The 7908 provides 16 Mbytes of mass storage, is based on 8-inch media, and utilizes Winchester head and media technology. Winchester technology provides several advantages, such as:

- Eliminates all preventative maintenance and alignment of the heads, disc, and spindles.
- Sealed head and media module prohibits handling of the media and prevents exposure to external contaminants.
- Improves reliability through a nonremovable media module; media cannot be improperly inserted or removed.

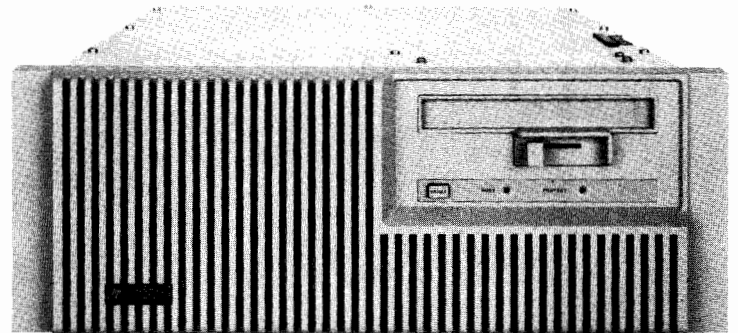

7908R



The built-in tape drive is a streaming mode 1/4 inch cartridge tape designed to back up low and medium capacity discs. It is also suitable for use as an I/O device on many HP systems. The media is a 'DC-600' type tape cartridge measuring 4 by 6 inches. Two cartridge capacities are available, offering 16.7 or 67 Mbytes of formatted storage to the user. Both tapes are completely interchangeable, requiring no reconfiguration or operator adjustments of the tape device. In addition, each cartridge undergoes conditioning at insertion and removal to position the head and tension the tape, contributing to tape reliability.

Each 7908 employs a resident microprocessor-based controller to manage both storage devices and provide many advanced capabilities enhancing performance and serviceability. The major functions include:

- 1) Disc and tape drive management
- 2) Offline backup and/or restore
- 3) Internal verification testing and sophisticated diagnostic routines
- 4) CS/80 Instruction Set

Controller firmware has the capability to manage both disc and tape operations, including disc-to-tape (backup) and tape-to-disc (restore) data transfers. These transfers can be performed without system supervision via an internal data path between the disc and tape drive.

Serviceability contributions of the 7908, internal verification testing and extensive diagnostic capabilities, reside in controller firmware. The internal verification test automatically occurs at power-on and provides a quick functional test to the replaceable assembly level. The comprehensive diagnostic package provides:

- 1) Isolation of 95 percent of drive failures to the replaceable assembly level
- 2) Automatic error logging onto dedicated maintenance tracks
- 3) Automatic data error rate verification

This package can be initiated on-line under system control, off-line under local control, or remotely through HP systems which support a modem link.

The 7908 is available in two packaging versions, a rackmount for technical applications, and an attractive, quiet, stand-alone cabinet for office environments. In both cases, the tape unit location is designed for easy tape cartridge insertion and removal.



Features

Disc Drive

- 16 Mbytes of formatted storage capacity
- Winchester head/media technology
- Fixed disc reliability

Built-In Cartridge Tape Drive

- 16.7/67 Mbyte formatted data storage capacity cartridges
- Easy to handle, reliable 1/4 inch cartridge tape media
- Automatic error correction
- 2 Mbyte per minute average data transfer rate

Integral Microprocessor-based Controller

- Shared controller for disc and tape
- Internal firmware to execute offline disc-to-tape and tape-to-disc data transfers (backup/restore)
- Automatic track and sector sparing
- Automatic seek and read retry
- Programmable sector interleaving and 4 kbyte buffer to allow matching of data transfer rate to a wide variety of systems
- Automatic error logging
- Extensive internal diagnostics
- HP-IB
- CS/80 Instruction Set

Operational Specifications

Disc Drive

Seek time

Track-to-track: 5 ms
Average random: 42 ms
Full stroke: 70 ms

Rotation

Speed: 3,600 rpm ($\pm 3\%$)
Average Rotational Delay: 8.3 ms

Data transfer rate

Burst: 1.0 Mbyte/s maximum
Average: 537.6 kbytes/s maximum

Capacity (formatted)

16.5 Mbytes minimum

Tape Drive

Tape speed

Read/Write: 60 ips
Search: 90 ips

Data transfer rate

Burst: 1.0 Mbyte/s maximum
Average (over internal data path): 35 kbytes/s (over HP-IB): 35 kbytes/s maximum

Operational Characteristics

Electromagnetic Emissions

The 7908 meets the conducted and radiated interference requirements for VDE 0871 level A and FCC Technical Standard for Class A Computing Equipment, September 18, 1978 Docket 20780 Part 15. On some HP systems, it meets VDE 0871 level B.

Safety

The 7908 meets all applicable safety standards of the following:
CSA 22.2 No. 143 and No. 154
IEC 380 and 435
UL listed (stand-alone cabinet) and recognized (rackmount) to UL 114 and UL 478

Configurations

The 7908P includes a built-in cartridge tape drive, 16.7 or 67 Mbyte tape cartridge, controller, power supply, stand-alone cabinet and 2 metre HP-IB cable.

The 7908R is the same as above except a rack-mountable package replaces the stand-alone cabinet.

Computer Interfacing Summary

Disc/Tape Drive	System					
	HP125	HP250S	9845	1000-L	1000EF	64000
7908P	X	X	X	X	X	X
7908R				X	X	

Ordering Information

7908P/R (16 Mbytes)
Opt 015: 220-volt operation
Opt 140: Delete cartridge tape drive

Price

\$9,900
NC
less \$2,000



COMPUTERS, PERIPHERALS & CALCULATORS

Line Printer, Laser Printing System, Tape Subsystem

Model 2608A Model 2680 Model 7976A

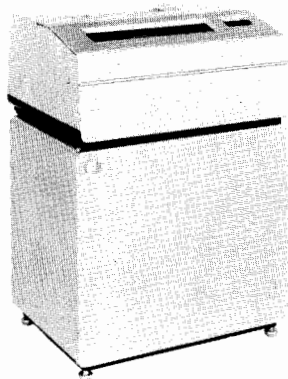

2608A

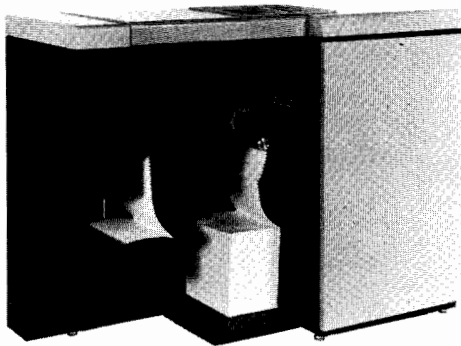

2680

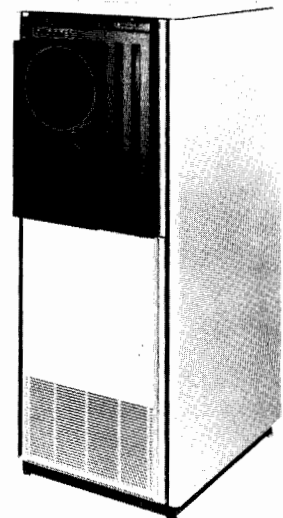

7976A



HP 2608A Line Printer

The HP 2608A is a low cost, highly reliable, medium speed, dot matrix line printer designed for use in most computer applications. Printing at 400 lines per minute, utilizing a high resolution matrix, the 2608A offers many special user features such as graphics, multiple character sets, 16 channel Vertical Format Control and double size characters. Above all, the 2608A is a printer designed for today's systems; rugged enough for many EDP applications, yet quiet enough to be compatible with office environments.

High reliability—The printing mechanism has few moving parts, operates virtually without friction, and requires minimum maintenance. In addition, the printer is microprocessor controlled for flexibility and increased functional capabilities as well as added reliability.

High quality print—The HP 2608A uses a high resolution dot matrix character cell for crisp, clear, character formation. The matrix size is automatically adjusted for different character sets to ensure the readability of the selected language.

2608A Line Printer

Price \$10,400.00

2680 Laser Printing System

The 2680 Laser Printing System (LPS) combines the 2680A Intelligent Page Printer and two powerful application software packages. The printer utilizes a laser activated electrophotographic process to print 45 pages per minute on plain, people-size paper (11 × 8½ inch). A scanning laser beam allows the flexibility of positioning dot images anywhere on the page.

The Interactive Design System (IDS/3000) is used for designing characters, symbols, and forms at a graphics terminal via simple cursor movements.

The Interactive Formatting System (IFS/3000) is used to configure output tailored to each user's needs. Character fonts, logos, symbols, forms, and even signatures designed with IDS/3000 can be selected for use in any printing application. The HP 2680A laser printer features continuous paper feed for paper handling reliability; non-contact fusing which is virtually maintenance free; and a data control system capable of handling variable size characters, electronic forms, and multiple pages of print on one sheet of paper.

2680A Intelligent Page Printer IDS/IFS Price to be announced

HP 7976A Magnetic Tape Subsystem

The Hewlett-Packard 7976A magnetic tape subsystem provides high speed, industry standard, one-half inch magnetic tape capability for HP 3000 computer systems. The unit is configured for two tape formats, and is able to read and write either ANSI standard 6250 bpi Group Coded Recording (GCR) data or the 1600 bpi, phase encoded (PE) format. The magnetic tape subsystem comes with an integral formatter/controller and features a high speed HP-IB interface suitable for use with all HP-IB HP 3000 computer systems. This subsystem may also be added to HP 3000 Series III systems by using the 30341A interface module. The tape subsystem is mounted in an attractive, upright rack cabinet, styled for use in all data processing environments.

The features of the 7976A include:

- Automatic tape loading/threading
- 250 ips rewind speed
- Front Panel (operator accessible) "go/no go" self test capability
- Extensive subsystem diagnostics available via RS-232C port built into the unit
- Dual channel error correction (6250 bpi only)

7976 Tape Drive 1600/6250

Price \$52,250.00

- 2.4, 4.8, 9.6 and 19.2 kb/s: four data rates cover a wide range of applications
- Range: up to 22 miles at 2.4 kb/s
- Operates in point-to-point and multi-drop modes

- Automatic equalization: optimises performance and simplifies installation
- Built-in diagnostics: simplifies installation, maintenance and testing
- Smaller and less expensive than conventional modems

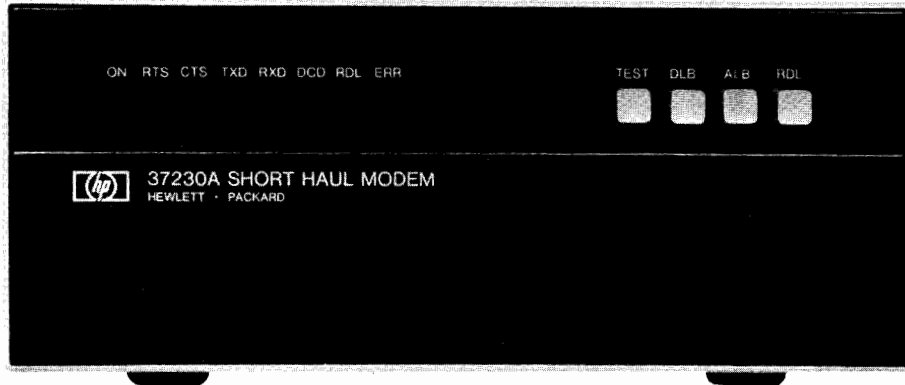

37230A

The 37230A Short Haul Modem provides synchronous transmission of data at rates of 2.4, 4.8, 9.6, and 19.2 kb/s. The unit is designed for half-duplex, full-duplex, and multi-drop operation over local circuits. It offers features similar to those of a conventional modem, but at lower cost. The 37230A is an economic alternative where transmission within a limited area is required.

The modem can be used over unloaded metallic circuits which are either installed privately or leased from the telephone company. The modem operates half-duplex on 2-wire circuits, and half-duplex, full-duplex, and multi-drop on 4-wire circuits. Suitable circuits can normally be obtained from the telephone company but may be restricted to within one end office (exchange) area. The 37230A complies with BSTR Pub 43401 and is also designed to meet the technical requirements of other authorities including many European PTT's.

An automatic equaliser in the modem receiver compensates for variable characteristics of the telephone circuit, optimising the performance throughout the specified range. This removes the need to perform any adjustments on the modem and simplifies the installation procedure. In multi-drop systems the central modem automatically readjusts its equaliser to compensate for whichever of the remote sites is transmitting.

The 37230A includes diagnostic test features similar to those found on conventional leased line modems. These include local and remote digital loopback, local analog loopback, and a test pattern generator/error detector. These facilities can be used for testing and fault-finding without the need for any other test equipment.

Range

The operating range of the 37230A depends on several factors including data rate, transmit signal level, and cable type used for the circuit. Typical operating ranges are shown in Table 1.

Table 1 Operating Range (max output level)

Data Rate	19 AWG 0.9mm	22 AWG 0.6mm	24 AWG 0.5mm	26 AWG 0.4mm
2.4 kb/s	22 miles	15 miles	12 miles	10 miles
4.8 kb/s	18 miles	12 miles	10 miles	8 miles
9.6 kb/s	13 miles	9 miles	7 miles	6 miles
19.2 kb/s	9 miles	6.5 miles	5 miles	4 miles

Note: test conditions: maximum send level; 140Ω terminating impedance; polythene insulated twisted pair cable simulator.

To meet the requirements of BSTR Pub 43401, the output level from the modem must be reduced for data rates above 2.4 kb/s. The required reduction in send level causes a corresponding reduction in range.

Remote Control of Loopback

Option 001 of the Short Haul Modem allows the diagnostic loopback facilities to be controlled via the DTE interface connector.

Specifications Summary

Operating mode: synchronous, 2-wire (half-duplex) and 4-wire (full-duplex, half-duplex, and multi-drop)

Data rates: (nominal) 2.4, 4.8, 9.6, 19.2 kb/s.

Digital interface: EIA RS232C/CCITT V.24 V.28 compatible.

Transmitter

Line coding: delay modulation (Miller code) plus scrambler.

RTS/CTS delay (nominal)

Constant carrier: 0 ms.

Switched carrier: ≤25 ms at 2.4 kb/s

≤15 ms at 4.8 kb/s

≤10 ms at 9.6 kb/s

≤8 ms at 19.2 kb/s

Output impedance: (nominal) 140Ω or 600Ω by internal strap selection. The transmitter also has a high impedance non-transmit mode for multi-drop operation.

Output spectrum: dependent on data rate. The output level may be strapped so that the line signal conforms to BSTR Pub 43401.

Receiver

Input impedance: (nominal) 140Ω, 600Ω, or high (≥10kΩ) by internal strap selection.

Line signal detector

Dropout level: -46 ± 3 dBm (measured with 1 kHz tone).

Pull-in level: 6 ± 2 dB above dropout level.

Dimensions: 102 mm (4.0 in) high
213 mm (8.4 in) wide
285 mm (11.2 in) deep

Options

001: Remote Control of Loopback

301: Rack Mount Kit

302: Dual Rack Mount Kit

Prices

add \$140

add \$30

add \$50

37230A Short Haul Modem

\$1190

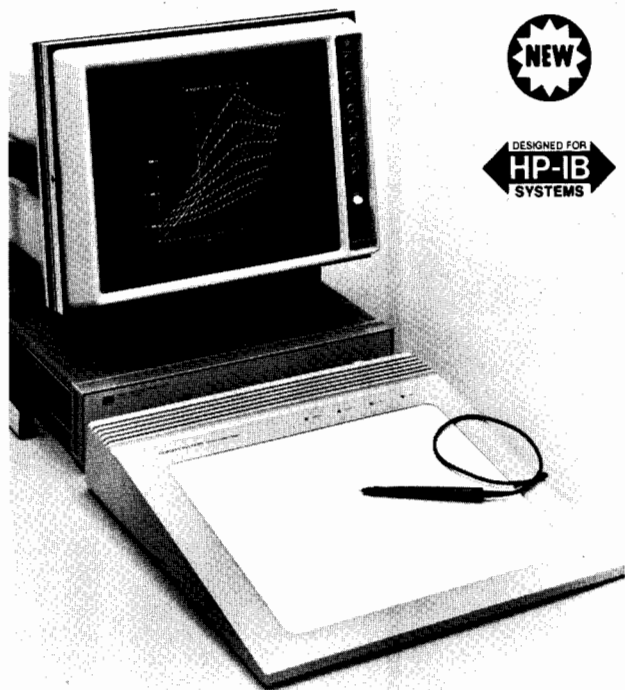

Interactive Graphics

An interactive graphics system utilizing the 9111A/Option 050 Graphics Tablet, a 1351S Graphics Display System, a plotter, such as the HP 9872A/B/C, and a controller, is ideal for a number of applications. One such is in the area of design. Design graphics involves the generation, manipulation, and portrayal of an object or objects. The graphic object(s) is usually associated with non-graphic information, such as calculations or software, which is stored in the controller (or computer). Both the generation and manipulation can be aided with the use of an interactive device like the 9111A Graphics Tablet.

At some point in a design cycle, a need will arise to manipulate existing data. With an interactive system the existing design can be quickly recalled and changed. This could include deleting or adding whole sections which would require a large amount of time to change by purely manual methods.

An interactive system involving the 9111A/option 050 and the 1351S gives the ability to create or change by selecting symbols or functions which the programmer has defined for the application. Rather than having to draw an often used symbol each time (like a resistor in a schematic), the representation can be defined, stored, and then recalled by the user. This symbol can then be combined with others to make larger and more complex blocks which can also be moved about or combined with others. All of this combining and building can be done without having to deal with the individual symbols which make up the whole.

The 9111A/Opt 050 utilizes some of the benefits of distributed intelligence by talking directly to the 1351A on several functions. This helps to free the host controller for other tasks since the controller need not 'babysit' the system. Not only does this speed up the updating process on the local level, it allows several interactive systems to

be used on the same computer (provided the computer has the capability to do so). This architecture eliminates the need for an expensive controller to handle each interactive system.

The 9111A option 050 Graphics Tablet 1351S system gives both the operator and programmer a great deal of control since the tablet is designed to carry on several functions with the 1351A independent of the controller. For instance, a cursor can be generated on screen by outputting the cursor's (tablet stylus) current location and then updating the location to the 1351A as the stylus is moved. The 9111A/Option 050 can update the 1351A as many as 60 times per second, so cursor movement appears smooth and continuous. This function's speed is aided by the lack of controller interaction. The 9111A/Opt 050 sends the X-Y coordinates to the 1351A in units it can understand when it is assigned as the talker and the 1351A as the listener. Data transfer is speeded because the controller doesn't need to 'massage' data from the Graphics Tablet into a form compatible to the 1351A.

The functions the 9111A/option 050 and the 1351A can carry on independent of the controller are:

- Symbol cursor
- Drawn cursor
- Rubber-band rectangle
- Single rubber-band line
- Double rubber-band line
- Forced horizontal line
- Forced vertical line

These functions can be software combined to create new functions which are even more powerful. By using the technique of interrupt driven operation the controller is called when the tablet stylus is pressed on the platen. This makes transition from the seven functions listed above to those requiring the controller fast and easy, placing no responsibility for understanding what is happening on the user. In addition, by using the programmable beeper on the 9111A/Opt 050, a user can be prompted audibly whether the action taken is inappropriate, or to confirm that the proper sequence has been performed.

The 9111A opt 050/1351S Interactive Graphics System allows you to interact very comfortably with a computer system. Writing on the Graphics Tablet with a stylus is more natural and less fatiguing than using a light pen on a CRT screen. The 1351S provides the fast information throughput, rapid picture manipulation, and complex vector drawing capability needed in interactive computer graphics. The 1351A can draw and update up to 8192 Vectors and/or characters, and 64 addressable memory files are available for selective blanking, erasing, or manipulation. A 14-inch directed beam electrostatic display is standard with the 1351S with optional display sizes of 17, 19, and 21 inches available. When the system is combined with an HP-IB plotter, hardcopy and softcopy are available.

System Applications

Some Applications include:

- Schematic generation
- Engineering design and evaluation (mechanical, electrical, chemical, etc.)
- Radar/Sonar control/monitoring
- Real-time instrumentation systems (data acquisition/analysis, production testing)
- Architectural design
- Materials for graphics presentations (drawings, graphs, etc., for overhead slides, handouts).

System Advantages

- Easily programmable with HPGL (Hewlett-Packard Graphics Language) via HP-IB
- Can be assembled using only one HP-IB bus
- High speed, high resolution
- Optional screen sizes, phosphors
- Gives ability to change and edit information quickly

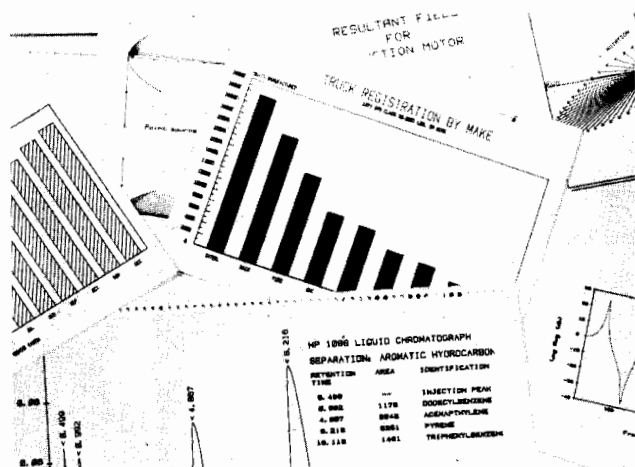

The increasing variety of Hewlett-Packard plotters and plotter/printers give disciplines, such as engineering, business, finance, and medicine a wide choice of graphic presentations. Because of this choice, data for each discipline can be interpreted with the type of graphics and text that will best produce clarity and professionalism. Depending on the HP plotting device, data relationships can be clarified with 8-color graphs; combined text and plots; 16½ foot long axis plots; or 7-color overhead transparencies. HP printing peripherals can simplify data with formatted text, selection of character sets, and many other effective, highly illustrative methods of presentation.

HP-GL Simplifies Graphics Programming

Most HP graphics plotters and plotter/printers accept the Hewlett-Packard Graphics Language (HP-GL). This powerful, but simple-to-use, plotter command set is comprised of 2-letter mnemonics with extensive parameters, designed specifically to draw, enhance, rotate, label, and color-highlight presentations. Depending on the plotting

peripheral, HP-GL provides the user with up to 60 straightforward commands to produce basic and sophisticated graphics.

User-Oriented Subroutines Minimize Plotting Effort

HP also offers two high-level graphics software packages to develop simple or complex graphics with minimum user effort and maximum efficiency in the use of computer time. One package called HP-PLOT/21, offers a set of graphic subroutines for the 7221 series compacted binary language plotters. The second package, called HP-ISPP, provides the user with a means of developing plots on all RS-232-C and HP-IB versions of HP's graphics plotters with HP-GL language capabilities. Both software packages permit simple installation on almost any ASCII based computer system. Refer to page 694 for package details and ordering information.

Printer Commands Provide Sophisticated Text

Simplified printer control commands produce a range of sophisticated text formats with the HP 7240A and 7245B. There are also commands to highlight text with underlining and alternate character sizes.

Interface Selection Makes Graphics More Accessible

HP graphics plotters and plotter/printers are designed to add graphics capabilities to the widest possible range of controllers designed by HP and other companies. Depending on the peripheral, these interfaces are available: Hewlett-Packard Interface Bus (HP-IB) which conforms to ANSI/IEEE 488-1978; EIA RS-232-C (CCITT V.24); General I/O (12-bit parallel); and 8, 12, 16-bit parallel.

HP Provides Supplies and Accessories

Hewlett-Packard plotters and plotter/printers are supported by HP quality controlled paper, pens and other supplies. For a complete listing of HP graphics supplies, request the Computer Supplies Catalog (part no. 5953-2450) from the local HP Sales and Service Office.

Chart Simplifies Peripheral Selection

The major features of a variety of HP hard-copy graphics devices, including the new 7580A drafting plotter are available below for comparison.

Features in Common	Special Features	Interface	Model #	Page #
Automatic 8-color plotting; high resolution vector graphics; 6 separate models; "T" models with paper advance, cut, and stack for unattended operation; 280 x 432 mm (11 x 17 in.) paper	HP-GL commands; buffer memory	RS-232-C (CCITT V.24)	7220C/T	686
	Compacted binary language for efficient data transmission at low baud rates; buffer memory	RS-232-C (CCITT V.24)	7221C/T	686
	HP-GL commands	HP-IB (ANSI/IEEE 488)	9872C/T	687
Low-cost, high-resolution vector plotting; fast manual pen changes; 216 x 280 mm (8½ x 11 in.) paper	Five user changeable I/O interfaces	HP-IB (ANSI/IEEE 488); RS-232-C (CCITT V.24) (2 versions); 8, 12, 16-bit parallel; G I/O	7225B	688
Thermal plotting and printing on one page; high-resolution moves; new sharp contrast output; unattended operation; 5 m (16½ ft) long-axis bidirectional plotting	HP-GL commands; buffer memory	RS-232-C (CCITT V.24)	7240A	693
	HP-GL commands; raster capability	HP-IB (ANSI/IEEE 488)	7245B	
Large format automatic 8-color plotting; high resolution four quadrant vector graphics on paper, vellum, or polyester film with fiber tip, roller ball, or liquid ink drafting pens; 203 x 267 mm (8 x 10½ in.) to 622 x 1190 mm (24.5 x 46.85 in.) media	HP-GL commands; buffer memory	RS-232-C (CCITT V.24)	7580A Option 001	690
	HP-GL commands; buffer memory	HP-IB (ANSI/IEEE 488)	7580A Option 002	



COMPUTERS, PERIPHERALS & CALCULATORS

Eight-Pen Vector Plotters

Models 7220C/T, 7221C/T, 9872C/T

- Programmable 8-color presentations
- Choice of 6 plotter designs

- Simplified programming of complex charts
- Available programmable paper advance with cutter

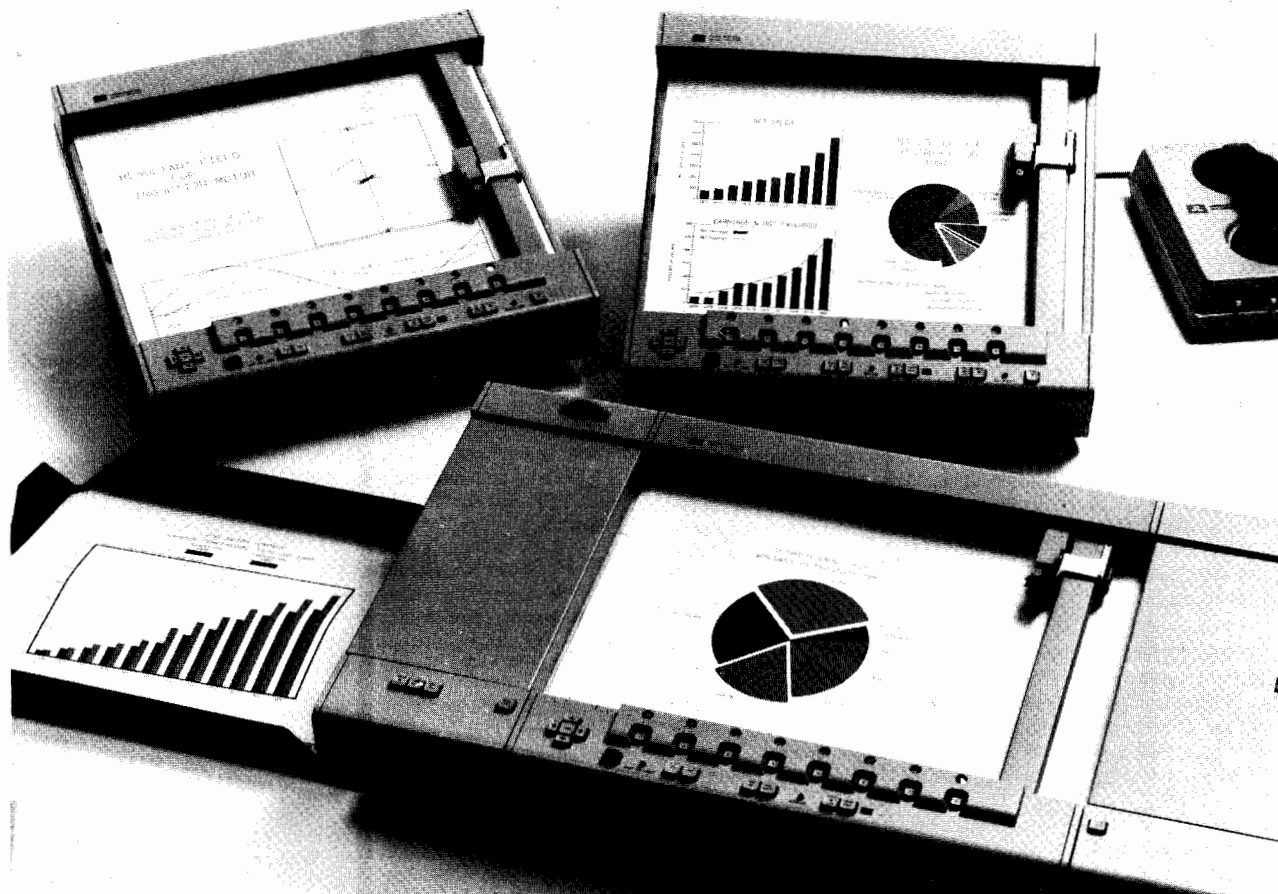

Hewlett-Packard offers six powerful plotters that can produce publication quality eight-color graphics on all page sizes up to ISO A3 or 280 x 432 mm (11 x 17 in.). With a single program command, or by pushbutton selection, a pen of another color can be specified to draw the next character or line. The pen stable on the front panel stores and caps pens automatically, keeping them fresh and ready for use. A special damping mechanism lowers pens gently, but quickly, onto the chart, preserving the fineness of the tip.

Some of the important plotting features of these units are: limits set by pushbutton, or under program control, to produce plot sizes up to 280 x 432 mm (11 x 17 in.); 36 programmable pen speeds to plot on many media, including clear film to make vivid 7-color transparencies; and programmable choice of character sets to produce documentation in many languages.

Publication quality graphics are achieved through microprocessor control that has an addressable resolution (step size) of 0.025 mm (0.001 in.) and plotting accuracy of $\pm 0.2\% \pm 0.2$ mm. Proper operation of the units can be verified by a user-actuated Confidence Test that checks the basic electronics and mechanics and draws a test pattern.

The models with a "T" model number suffix are also equipped with a programmable paper advance and self-sharpening cutter. These

Six versatile 8-pen vector plotters are presently available. Each plotter has the same basic plotting features, providing quality graphics for controllers with different I/O interfaces.

"T" models store a 280 mm x 61 m or 11 in. x 200-foot roll of paper which is advanced and cut, if required, under program or pushbutton control.

The 7220C/T and 7221C/T Explained

The 7220C/T and 7221C/T are designed with an EIA RS-232-C (CCITT V.24) asynchronous serial ASCII interface, so they can be connected through a modem, or hardwired, to desktop computers, terminals, computer systems, and microprocessor-based systems. The plotters have a user-selectable baud rate from 75 to 2400 and over 900 bytes of buffer memory.

The 7220C/T are programmable with an extensive set of easy-to-use Hewlett-Packard Graphics Language (HP-GL) commands. This command set, designed specifically for graphics production, provides over 50 logical two-letter commands to produce a wide range of professional graphics. ISPP (17580A), HP's Industry Standard Plotting Package, supports the 7220C/T plotters. Refer to page 694 for package details and ordering information.

The 7221C/T are programmable with a data-efficient compacted binary language, designed to be particularly effective at low baud rates, such as used on standard telephone lines. HP-PLOT/21 (72021C) supports the 7221C/T plotters. Refer to page 694 for package details and ordering information.

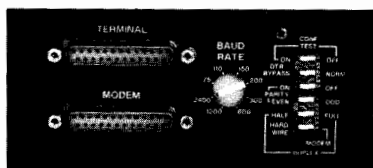

The rear panel interface sections of the 7220C/T and 7221C/T are the same. Mounted on these sections are user-oriented switches that select one of eight baud rates, from 75 to 2400 baud; activate a Confidence Test that affirms the operation of the plotter and draws a diagnostic pattern; plus other switches that select terminal or plotter DTR control; odd, even, or off parity mode; half or full duplex; and hardwired or modem configuration.

The 9872C/T Explained

The 9872C/T have the Hewlett-Packard Interface Bus (HP-IB) that conforms to ANSI/IEEE 488-1978: SH1, AH1, T2, L2, SR1, RL0, PP2, DC1, DT0. With this interface, the 9872C/T can be controlled by HP terminals, desktop computers, computer systems, microprocessor-based instruments, and non-HP systems that communicate through the IEEE 488 interface. Like the 7220C/T, the 9872C/T are programmed with HP-GL commands. In addition, the 9872C/T are supported by higher level graphics language commands available in HP desktop computer firmware and computer system software.

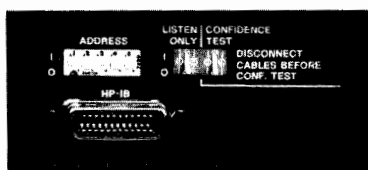

The rear panel interface sections of the 9872C/T are the same. These sections offer user-oriented switches to set up to 31 unique addresses for controller interfacing; a listen-only mode to interface with microprocessor controlled instrumentation or data storage devices; and activate a Confidence Test that affirms the operation of the plotter and draws a diagnostic pattern. The HP-IB connector provides interfacing for an HP-IB (IEEE 488-1978) compatible controller.

Eight-Pen Plotter Specifications

Plotting sizes: Media up to ISO A3 (297 x 420 mm) or 280 x 433 mm (11 x 17 in.)

Mechanical limits: Y axis—285 mm (11.2 in.); X axis—400 mm (15.75 in.)

Plotting accuracy: ±0.2% of deflection ±0.2 mm (0.008 in.), including linearity and repeatability (based on plotter being “zeroed” to exact lower left (0,0) coordinates)

Repeatability: For a given pen, 0.10 mm (0.004 in.); Pen-to-pen, 0.020 mm (0.008 in.)

Addressable resolution (step size): 0.025 mm (0.001 in.)

Plotting speed: Maximum—360 mm/s (14 in./s) in each axis or 509 mm/s (20 in./s) on 45° angle. Programmable to 36 speeds from 10 mm/s (0.4 in./s) to 360 mm/s (14 in./s) in 10 mm/s (0.4 in./s) increments

Environment range: Temperature—0°C to 55°C; Relative humidity—5% to 95% (below 40°C)

Size/Weight:	C Model	T Model
Height	189 mm (7.4 in.)	210 mm (8.3 in.)
Width	497 mm (19.5 in.)	858 mm (33.7 in.)
Depth	477 mm (18.7 in.)	477 mm (18.7 in.)
Net weight	18 kg (39 lb)	30 kg (66 lb)
Shipping weight	31 kg (69 lb)	50 kg (110 lb)

Power Requirements: Source—100, 120, 220, 240V -10%, +5% (factory set); Frequency—48-66Hz single phase; Consumption—180 watts maximum

Eight-Pen Plotter Accessories Supplied

Item	Part No.
Digitizing Sight	09872-60066
Operating and Programming Manual	
7220C/T	07220-90003
7221C/T	07221-90024
9872C/T	09872-90011
Pocket Guide	
7220C/T	07220-90005
9872C/T	09872-90013
Dust Cover	
C model	9222-0742
T model	9222-0741
Male to Male Interface Cable	
7220C/T	07221-60157
7221C/T	07221-60157
Paper Tray Assembly, T models only	17072-60251
Fiber Tip Plotter Pens	
5-pen pack, black	
Quantity 1, regular tip (0.3 mm)	5060-6787
Quantity 1, broad tip (0.7 mm)	5060-6890
4-pen pack (1 pen each of black, red, blue, green)	
Quantity 2, regular tip (0.3 mm)	5060-6810
Quantity 1, broad tip (0.7 mm)	5060-6858
6-pen pack (1 pen each of gold, brown, burnt orange, lime green, turquoise, violet)	
Quantity 1, regular tip (0.3 mm)	5060-6894
Quantity 1, broad tip (0.7 mm)	5060-6895
Plotter Paper (Metric or English sized paper is included with each plotter depending on area to which the plotter is shipped)	
C model:	
300 sheets, unprinted, 279 x 420 mm (11 x 16.5 in.)	9280-0518
and 300 sheets, unprinted, either 210 x 297 mm (metric), or	9280-0519
8½ x 11 in. (English)	9280-0517
T model:	
300 sheets, unprinted 279 x 420 mm (11 x 16.5 in.)	9280-0518
and 1 roll, unprinted, either 297 mm x 61 m (metric) or	9280-0494
279 mm x 61 m (11 in. x 200 ft English)	9280-0493
Ordering information for additional supplies is contained in the HP Computer Supplies Catalog (5953-2450).	

Options for 7220C/T or 7221C/T

Option no.	Description	Price
001	2048-byte additional buffer memory	\$225

Options for 9872C/T

(The following options are for purposes of documentation)

Option no.	Description	Price
025	For use with HP 9825	N/C
045	For use with HP 9835 and HP 9845B	N/C
085	For use with HP 85	N/C
100	For use with HP 1000	N/C
145	For use with HP 9845C	N/C
300	For use with HP 3000	N/C

Ordering Information

Voltage will be set and power cables and metric or English paper will be supplied in accordance with area to which the plotter is shipped.

7220C, 7221C, or 9872C Eight-Pen Vector Plotters	\$5300
7220T, 7221T, or 9872T Eight-Pen Vector Plotters	\$7250



COMPUTERS, PERIPHERALS & CALCULATORS

Low-Cost Plotter With Plug-In Interfaces

Model 7225B

- 5 user plug-in I/O interfaces
- Cost-effective graphics
- Superior line quality and repeatability

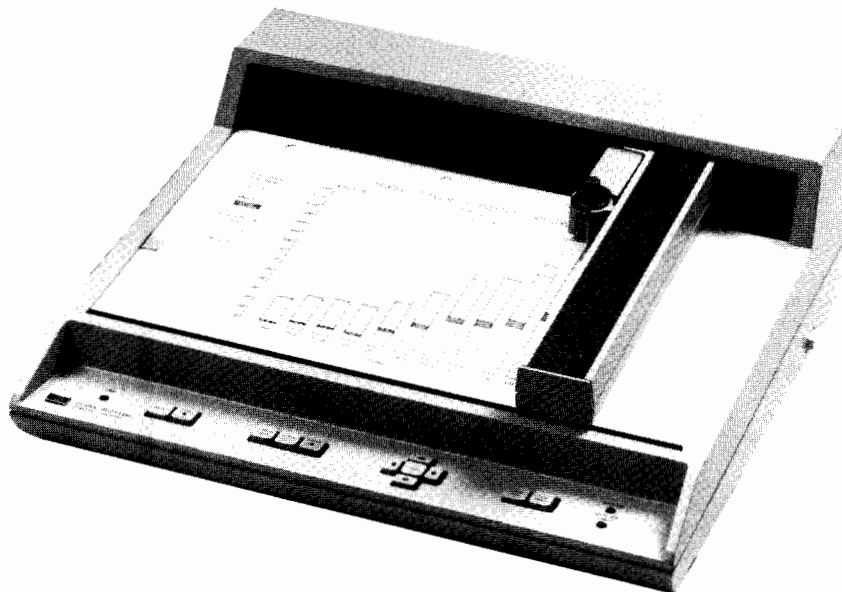

The 7225B is a compact and cost-effective plotter that produces professional graphics on ISO A4 or 216 x 280 mm (8½ x 11 in.) paper.

The design principles that govern the production of the 7225B are high performance without high price; low cost of ownership through modular construction; and flexibility through user-changeable Personality Modules.

All interface capabilities for the 7225B reside in the plug-in Personality Module; so, with a simple change of Module, the user can configure the unit to provide graphics for a wide variety of desktop computers, computer systems, and microprocessor-based systems.

The 7225B is FCC certified as meeting Class B RFI standards when connected to a certified Class B personal computer, such as the HP-85.

Motors Designed as Durable Modules

The 7225B contains two stepper motors. Combining rugged simplicity with state-of-the-art technology, the motor modules are designed without pulleys, cables, gears, or slidewires to avoid the need for scheduled maintenance or adjustments. The motors also accept an addressable microstep of 0.032 mm (0.0013 in.) which increases both plotting accuracy and appearance.

Besides ruggedness and microstep size, the motors are designed to control accuracy to ± 0.25 mm (0.01 in.), including linearity and repeatability. Because of these and other design features, the 7225B continues to produce quality graphic representations, even under long-term heavy use.

Features Provide Ease of Use

The 7225B has a number of sophisticated features that simplify operation. For example, the user-oriented front panel contains pushbuttons that provide manual control of plotting limits; pen raising and lowering; pen movement in four orthogonal directions and at any chosen 45° angle; plus lamps that automatically signal error and out-of-limits conditions. A back panel pushbutton activates the Confidence Test that verifies the basic mainframe and Personality Module performance.

Because the 7225B depends on the Personality Module for its capabilities, a mainframe can be configured to simplify the programming of sophisticated graphics by a high-level of compatibility between the power of the controller and the responsiveness of the plotter with the appropriate Personality Module.

Plug-in Modules Provide Interfaces

At the present time five Personality Modules are available: General I/O (12-bit parallel), Hewlett-Packard Interface Bus (HP-IB) which conforms to ANSI/IEEE Standard 488-1978, two versions of the RS-232-C (CCITT V.24), and 8, 12, 16-bit parallel. When purchasing a 7225B, one of these modules must be ordered.

General I/O (12-bit Parallel)—17600A

Adapts the 7225B to HP desktop computers, such as the 9815, 9820, 9821, 9825, 9830 and 9831. The 17600A decodes computer-originated commands; sends pen positioning and status data to the 7225B; and includes the Module in the Confidence Test. The capability of the 7225B with the 17600A Module is enhanced by the desktop computer in the configuration.

HP-IB (ANSI/IEEE Standard 488-1978)—17601A

Adapts the 7225B to HP and other desktop computers, computer systems, intelligent terminals, and microprocessor-based systems with interfaces that are compatible with ANSI/IEEE Standard 488-1978: SH1, AH1, T2, L1, SR1, RL0, PP2, DC1, DT0. The 17601A accepts the full Hewlett-Packard Graphics Language (HP-GL) instruction set that includes commands to specify five built-in character sets, seven dashed line fonts, user-defined symbols, point digitizing, and user-specified integer scaling. The panel of the 17601A includes a plotter address switch and a Listen Only-Addressable switch to make the 7225B useful in computer-based configurations. The Listen Only mode allows a group of plotters to accept commands from a single controller. Testing of the basic electronics in the 17601A is also done by the Confidence Test.

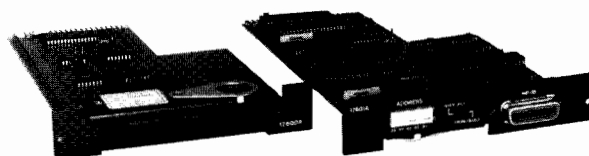

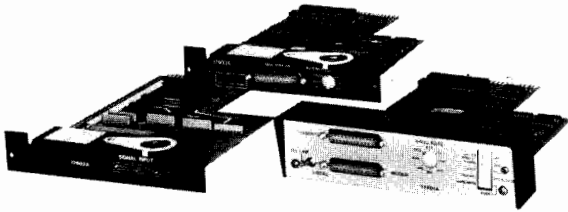

8, 12, 16-bit Parallel — 17602A

Adapts the 7225B to computer systems and microprocessor-based systems with an applicable interface. Position data can be 4 or 8-bit words in BCD or Binary. This Personality Module is particularly useful with plotter controllers, such as those in the OEM market, because all control panel pushbutton logic is available at the back panel connector. The 17602A controls absolute and relative coordinate moves; raises and lowers the pen; and includes the Module in the Confidence Test.

RS-232-C (CCITT V.24) Compatible — 17603A

Adapts the 7225B to be hardwired to in-house computer systems and desktop computers with RS-232-C (CCITT V.24) capabilities. The 17603A provides switch selection of seven baud rates: 110, 150, 200, 300, 600, 1200, and 2400. In addition, there is a switch position to allow baud rate selection by the controller. A second switch is used to select odd, even, or no parity. The 17603A accepts Hewlett-Packard Graphics Language (HP-GL) instructions and a software "handshake" procedure, made even more efficient by a standard buffer of 630 usable bytes. A hardwired handshake is included in the connector, providing hardware plotter control from a wide range of OEM controllers. The Module is included in the Confidence Test.

RS-232-C (CCITT V.24) with Eavesdrop — 17604A

Adapts the 7225B to RS-232-C interface systems configured with a modem. The 17604A also provides an "eavesdrop" feature, so a 7225B on the communications line between a terminal and a computer, or modem, can react to instructions from either controller. The 17604A is designed with seven switch-selectable baud rates (110, 150, 200, 300, 600, 1200, and 2400), plus a switch position to allow baud rate selection by the controller. A second switch is used to select odd, even, or no parity. The 17604A accepts the Hewlett-Packard Graphics Language (HP-GL) and provides firmware to make arcs and circles with a single command. In addition, the 17604A is configured with a built-in software "handshake" procedure that includes 630 usable bytes of buffer, plus a hardwired handshake integrated into the rear connector. This dual handshake capability, plus eavesdrop, greatly increase the I/O power and versatility of the 7225B. The Module is included in the Confidence Test.

7225B Specifications

Plotting sizes – Paper: Up to ISO A4 or 216 x 280 mm (8½ x 11 in.). Plotting area: 203 x 285 mm (8.1 x 11.2 in.)

Plotting accuracy: ±0.25 mm (0.01 in.), including linearity and repeatability, based on plotter being "zeroed" to exact lower left (0,0)

Repeatability: 0.1 mm (0.004 in.) from any given point.

Addressable resolution (step size): 0.032 mm (0.0013 in.)

Vector length: Any length within plotter's mechanical limits

Plotting speeds: Vectors: 250 mm/s (10 in./s) in either axis or 350 mm/s (14 in./s) at 45°. Characters: Up to three 2.5 mm (0.1 in.) characters/s

Power requirements: Source: 100, 120, 220, 240 V – 10% +5% (selected internally). Frequency: 48–66 Hz. Consumption: 70 W maximum

Size: 140 high x 413 wide x 379 mm deep (5.5 x 16.3 x 14.9 in.)

Weight: Net: 8 kg (17.6 lb). Shipping: 11.4 kg (25 lb)

Accessories and Supplies

Refer to the HP Computer Supplies Catalog (5953-2450) for ordering information.

7225B Options

The 7225B mainframe order requires the specification of one power option (001-004), one Personality Module, and the applicable operating and programming manual for the Personality Module.

Option no.	Description	Price
001	100 Vac power	N/C
002	120 Vac power	N/C
003	220 Vac power	N/C
004	240 Vac power	N/C
006	Paper/pen supplies kit: 15 pads (50 sheets/pad) ISO A4 (210 x 297 mm) paper, 6 each 5-pen pkgs (0.3 mm nib width; 2 blk, 2 red, 1 blu, 1 grn), and a sturdy pen holder.	\$95
007	Same as 006, except paper is 216 x 280 mm (8½ x 11 in.)	95
010	Vinyl carry case (not for shipping use)	220

17600A Personality Module Options

The following options are for operating and programming manuals and interface cables for HP desktop computers.

Option no.	Description	Price
001	Cable for 9815	\$300
002	Cable with plotter ROM for 9820 and 9821	420
003	Cable for 9825	420
004	Cable for 9830	300
015	Manual for 7225A/B with 9815A/S. 9815A must have option 002 (2 I/O channels) or 98122A field kit.	N/C
020	Manual for 7225 with 9820, using plotter ROM supplied with 17600A option 002.	N/C
021	Manual for 7225 with 9821, using plotter ROM supplied with 17600A option 002.	N/C
025	Manual for 7225 with 9825, using 98212A or 98214A ROM.	N/C
030	Manual for 7225 with 9830, using existing 11271B or 11271F ROM.	N/C

17601A Personality Module Options

The 98034 cable should be available to connect the 7225B/17601A (HP-IB) plotter to an HP desktop computer.

Option no.	Description	Price
001	Manual for 7225 with HP desktop computers, intelligent terminals, and computers not listed below.	N/C
025	Manual for 7225 with 9825 using plotter ROM	N/C
026	Manual for 7225 with 9826A (HP-IB and graphic language support).	N/C
035	Manual for 7225 with 9835	N/C
045	Manual for 7225 with 9845	N/C
085	Manual for 7225 with HP-83/85	N/C

17602A Personality Module Options

General operating and programming manual furnished with the Personality Module.

Option no.	Description	Price
001	Male I/O connector	\$30

17603A Personality Module Options

General operating and programming manual furnished with the Personality Module.

17604A Personality Module Options

General operating and programming manual furnished with the Personality Module.

Ordering Information

Item	Price
7225B Graphics plotter mainframe	\$2450
17600A Personality Module	150
17601A Personality Module	750
17602A Personality Module	200
17603A Personality Module	750
17604A Personality Module	900

OEM discounts available.



COMPUTERS, PERIPHERALS & CALCULATORS

Eight-Pen Drafting Plotter

Model 7580A

- Accommodates media sizes up to ISO A1 (ANSI D)
- Choice of pen/media combinations
- Quality labeling in two style fonts
- Suitable for most work environments
- HP-IB or RS-232-C (CCITT V.24) interface
- Fast, high quality output

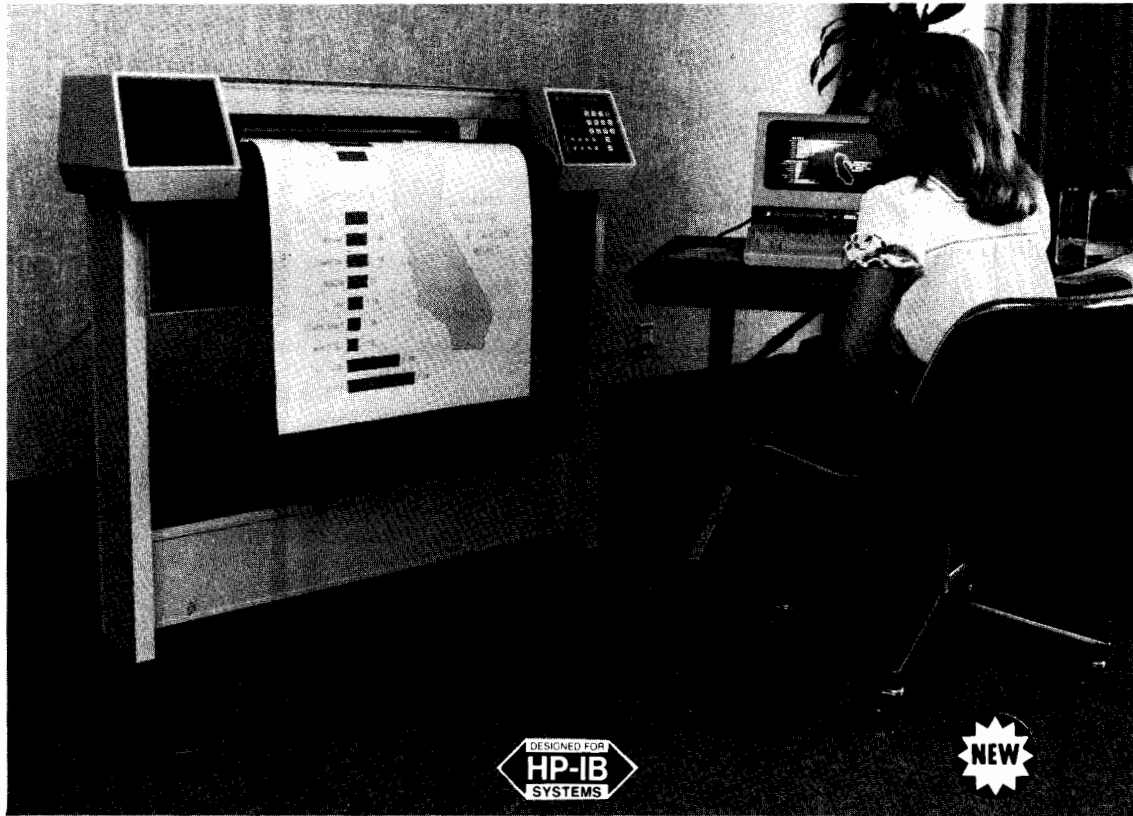

7580A

The Model 7580A Drafting Plotter is designed to produce high-quality graphics on individual sheets, including pre-printed forms, made of paper, vellum, or double matte polyester film. Plots can be drawn on media sizes ranging from ISO A4 through A1 (ANSI A through D) with a choice of roller ball, fiber tip, or liquid ink drafting pens of various colors and line widths. Up to eight pens can be used without operator intervention. Pens are capped when not in use so that pens last longer and write without repriming. Another innovative feature is the drive mechanism, which offers savings in both physical size and cost. The plotter is available with either an HP-IB or RS-232-C (CCITT V.24) interface to permit its use in a variety of computer environments.

Media Drive Mechanism

The compact size of the plotter is achieved using the micro-grip drive technology developed in Hewlett-Packard laboratories. This drive system uses a low mass, low inertia mechanism to grip and move the drawing medium. This permits the use of smaller, less expensive motors and lighter parts. You get impressive resolution and repeatability, high throughput, quality output, and reliability for less cost.

Advanced Writing System

The basic value of any plotter lies in the capabilities of its writing system. Starting with perhaps the easiest media loading of any plotter made, the 7580's writing system automatically senses paper size and sets the limits of pen motion. Even the pen height is automatically controlled, eliminating the need for the manual adjustments required on many other plotters. Precision control over the settings of velocity, acceleration, and pen force ensures high quality output on various ink/media combinations.

High Quality Output

Resolution and repeatability are two important factors which affect line quality. While the addressable resolution of the plotter is 0.025 mm (0.001 in.), pen and medium movements actually occur on a finer grid to create lines of the highest visual quality. These pen and medium movements are controlled by DC servos for a mechanical resolution of 0.003 mm (0.00012 in.). Repeatability, the ability of the plotter to return to a given point, is within 0.05 mm (0.002 in.), truly amazing when you see how quickly the medium moves.

High Throughput

Acceleration and velocity are key ingredients of high throughput. At 60 cm/s maximum velocity and 4 g's acceleration, the 7580A is the fastest plotter in its price range. Even when slower pen-down speed is required because of the drawing medium, throughput remains high because pen-up moves are always executed at maximum speed.

Pen Carousels

There are three different pen carousels—one for each type of pen. Each carousel holds up to eight pens and is coded so that the plotter electronically senses carousel type each time a carousel is loaded. After determining the carousel type, the plotter sets values for velocity, acceleration, and pen force which are suitable for most plots using pens of that type. Since all this is automatic, it is remarkably easy for the operator to set up the plotter. Yet, if an application requires it, the values of force, acceleration, and velocity can be changed from the automatically-set values using front panel controls or by programmed plotter instructions. Because pen force and velocity can be set for each pen individually, pens of different types may even be mixed in the same carousel.



Intelligent Pen Control System

Another innovation is the pen control system. For instance, on descent, pen motion is damped as the pen approaches the surface of the medium so that delicate pen tips are not damaged and pen bounce is minimized. Pens last longer and plotted lines are uniform from their inception. Two different pen-lift heights have been implemented to maximize throughput by minimizing pen-lift delays. The pen is raised only slightly for small moves, as when labeling, and attains its maximum height only for long moves. Finally, pen height above the media's surface is electronically controlled so the operator never needs to make mechanical adjustment in pen height, even when changing pens or media.

Quality Labeling

Six different character sets in two style fonts provide the plotter user with a large range of annotation capabilities including mapping symbols, special centered symbols, and foreign-language characters.

Simple, Powerful Command Set

Programming is easy using the Hewlett-Packard Graphics Language (HP-GL). The 60 commands implemented on the 7580A are simple, yet powerful. In addition to single commands to draw lines, there are commands to draw a circle or arc, to position labels, change character size, slant, and direction, digitize, and more. It's even smart enough to adjust dashed line patterns to fit between any two points. It can also rescale the plotting area in convenient user-defined units, rotate your plot 90 degrees, or "window" and plot only a portion of the data.

Software Support

The 7580A is supported on a number of Hewlett-Packard computer systems, desktop computers, and intelligent terminals. This support, consisting of high-level graphics programming instructions, enhances programmer productivity and ease of use. Several graphics application software packages support the 7580A on HP computers.

For users of industry-standard Fortran subroutines, a software package, ISPP, Industry Standard Plotting Package, is available. Refer to page 694 for package details and ordering information.

Applications

The HP 7580A is well suited for a variety of applications including computer-aided design of printed circuit boards, integrated circuits and mechanical parts, automated drafting, civil engineering, mapping and cartography, as well as business and management. Its small physical size makes it suitable for almost any work environment. It can even be rolled easily from one room to another to serve more than one work station or application.

Specifications

Plotting Area

Medium size:	Accommodates media from 203 x 267 mm (8 x 10½ in.) to 622 x 1190 mm (24.5 x 46.85 in.)
Maximum plotting area:	Medium size less margins
Margin size:	
Expanded mode:	Three margins of approximately 5 mm, fourth margin is approximately 29 mm
Normal mode:	Three margins of approximately 15 mm, fourth margin is approximately 39 mm

Resolution

Smallest addressable move:	0.025 mm (0.001 in.)
Mechanical resolution:	0.003 mm (0.00012 in.)

Repeatability

For a given pen: 0.05 mm (0.002 in.)

Speed

Pen down:	
Maximum:	60 cm/s (24 in./s) independent of vector direction
Programmable:	1 to 60 cm/s in 1 cm increments (0.4 to 24 in./s)
Front panel selectable:	from 10 to 60 cm/s in 10 cm increments
Pen up:	60 cm/s (24 in./s) independent of vector direction

Acceleration

Maximum:	4 g's (39 m/sec ² , 129 ft/sec ²)
Programmable:	1 to 4 g's in 1 g increments (9.75 to 39 m/sec ² , 32 to 129 ft/sec ²)

Pen Force

Programmable and front panel selectable: 10 to 66 gram weights in 8 gram increments

Pens

Number of pens:	8/carousel
Pen types:	fiber tip, liquid ink, roller ball

Media

Most standard paper, vellum, and double matte polyester film, 3 or 4 mil thick
1024 bytes

Buffer size

Power requirements

Source:	100V, 120V, 220V, 240V -10% +5%
Frequency:	48-66 Hz single phase
Consumption:	170 watts max

Environmental range

Operating:	Temperature 0°C to 55°C Relative humidity 5% to 95% (below 40°C)
Non-operating:	Temperature -40°C to 75°C Relative humidity 5% to 95% (below 40°C)

Size/weight

Height:	1188 mm (46.8 in.)
Width:	1087 mm (42.8 in.)
Depth:	557 mm (21.9 in.)
Net weight:	59.1 kg (130 lb)
Shipping weight:	approximately 114 kg (250 lb)

Interface

HP-IB (IEEE 488-1978): SH1, AH1, T6, L3, SR1, RL0, PP2, DC1, DT0
or
RS-232-C/CCITT V.24 asynchronous serial ASCII with switch selectable baud rates of 110, 150, 300, 600, 1200, 2400, 4800, 9600

Accessories Supplied

	HP Part No.
Operating and Programming Manual	07580-90000
Operator's Manual	07580-90002
Programmer's Reference Card	07580-90003
3 Pen Carousels	
liquid ink carousel	07580-60081
roller ball carousel	07580-60082
fiber tip carousel	07580-60035
Digitizing Sight	09872-60066
Male-to-male RS-232-C/CCITT V.24 cable (supplied with 7580A option 001 only)	8120-3258

An assortment of pens and various drawing media and a brush are also provided with the plotter.

Drafting media, various pens and other plotter supplies are available from Hewlett-Packard. Please refer to the HP Computer Supplies Catalog (5953-2450) for a complete listing. Media and liquid ink plotting pen tips may be purchased from your local engineering supply store. Refer to the HP 7580A Operator's Manual for information on suitable pen tips and media.

Options

Option no.	Description	Price
001	RS-232-C/CCITT V.24 interface	N/C
002	HP-IB interface	N/C
025	for use with HP 9825 desktop computer	N/C
045	for use with HP 9835A/B or HP 9845A/B desktop computer	N/C
047	for use with HP 2647 graphics terminal	N/C
085	for use with HP 85 personal computer	N/C
100	for use with HP 1000 computer	N/C
145	for use with HP 9845C desktop computer	N/C
300	for use with HP 3000 computer	N/C

Ordering Information

7580A Drafting Plotter
OEM discounts available

Price
\$15,450



COMPUTERS, PERIPHERALS & CALCULATORS

Graphics Tablet & Digitizer

Models 9111A, 9874A



9111A Graphics Tablet

Hewlett-Packard's 9111A is a graphics tablet which can open up new fields of user interaction in graphics and menu applications.

The 9111A can be used as a cursor mover in interactive graphics. Single point or continuous digitizing modes may be used to enter raw graphics data into a host computer. The binary cursor transfer combined with the single point digitizing mode are a perfect combination for cursor moving and "picking" in interactive graphics.

A programmable cursor position update rate of up to 60 updates per second allows matching the cursor update to your display refresh rate. A binary cursor transfer is provided for maximizing the data transfer rate, allowing inputting the cursor location without having to translate from ASCII characters to internal integer representation. This is in addition to the standard HP-IB character string which is easy to use with high level languages.

The 9111A's 16 softkeys provide a "hardware" menu, with interpretation built into the graphics tablet. The user selects a key by positioning the stylus in one of the 16 softkey boxes and pressing down to activate the digitizing switch.

Quality and durability are apparent from the 9111A's platen and stylus. The hard ceramic material will not easily scratch or pit. The stylus is slim and lightweight with good tactile feedback on the switch position. Interchangeable inked and non-inked refills are available.

A four-octave beeper, with programmable frequency, duration and loudness, is provided for an audio response channel.

Through the standard HP-IB interface (HP's implementation of IEEE-1978), the 9111A is compatible with a wide variety of computers and terminals from HP. The 9111A's repertoire of 25 HP-GL commands provides the user with precise control of all its functions.

9111A Graphics Software Utilities

Utility software is available for use with HP-85, HP 9845B, and HP 9845C computers. The 9111A-9845B software utilities include a drawing program, a graphics editor which allows the user to pick and place elements from a menu, and a menu driver for user-designed menus. The 9111A-9845C software utilities include color fill of polygons, but are otherwise nearly identical to the 9111A-9845B utilities. 9111A-HP 85 software utilities include a drawing program, a graphics entry program for digitizing, and a planimeter program for measuring line lengths and areas. Each 9111A software utility includes a manual, tape cartridge(s), and menu overlays.

9111A Option 050 Graphics Tablet

The 9111A option 050 tablet is specially designed for use with the HP 1350S or HP 1351S graphics display system. This combination provides for direct interaction between the display and tablet for cursor movement and rubber banding of lines and rectangles. The benefit of this configuration is high performance, quick response time, and minimized computer overhead. Since the option 050 command set is a superset of the 9111A, it can be used on any system which supports the 9111A. The 135X/9111 graphics display system is supported on the graphics 1000-II software.

Options for 9111A

Option no.	Description	Price
045	Tutorial manual for use with HP 9845B	N/C
050	Specially designed 9111A for use with 1350S/1351S; includes manual	\$525
085	Software and manuals for use with HP 85	N/C
100	For use with HP 1000	N/C
145	Manual for use with HP 9845C	N/C

Ordering Information

	Price
9111A Graphics Tablet	\$2050
88100A 9111A-9845B Utility Software	\$500
88101A 9111A-9845C Utility Software	\$500

9874A Digitizer

The 9874A Digitizer provides a convenient method of entering graphic information into computers using the HP-IB (IEEE Standard 488-1978) interface including any HP Series 9800 Desktop Computer, the HP 1000 Minicomputer and the 2647A Intelligent Graphics Terminal.

Used in numerous applications—strip chart analysis, mapping and resource management, medical research and treatment, and destructive and non-destructive test analysis—the 9874's advanced features make it easy to control an entire application right from the digitizer.

Features include an adjustable glass platen that enables digitizing exact images without distortion from a wide variety of projectable media such as X-rays, movies and 35 mm slides.

A unique vacuum cursor adheres to any area of the platen. It is lighted, and has an open-circle target, 0.250 mm in diameter, giving pinpoint precision to accurately position and move.

In addition, the 9874 has microprocessor intelligence. It also has a control pad with digitizer control, Special Function and numeric entry keys, and a self-test feature. Points may be digitized one at a time or continuously (based on the time or distance increments) by simply pressing the appropriate key. An axis align key automatically aligns the X and Y axes of the digitizer with those of the document, matching the digitizer coordinate system to the document being used.

Forty different instructions, available on the 9874, simplify programming and increase communication efficiency. Additional ROMs are available for HP desktop computers to simplify and expand the language capability. Although not required, these language ROMs are helpful when programming the desktop computers.

Features

- Adjustable glass platen
- Automatic alignment of the coordinate system
- Free-moving cursor or stylus
- Cursor Vacuum System
- Rear projection of graphic images
- Microprocessor intelligence
- Axis extension capability for large documents
- Special function keys
- Auto-sampling by time or distance increments

Options for 9874A

Option no.	Description	Price
015	Manual for use with HP 9815	N/C
025	Manual for use with HP 9825	N/C
030	Manual for use with HP 9830	N/C
035	Manual for use with HP 9835	N/C
045	Manual for use with HP 9845B. Includes software programs for strip chart digitizing, distance and area measurement, and curve fitting.	N/C

Ordering Information

	Price
9874A Digitizer	\$9500

- Quality graphics and printing on the same page
- New high-contrast output
- 5m (16.4 ft) long-axis plots
- HP-IB or RS-232-C (CCITT V.24) interface

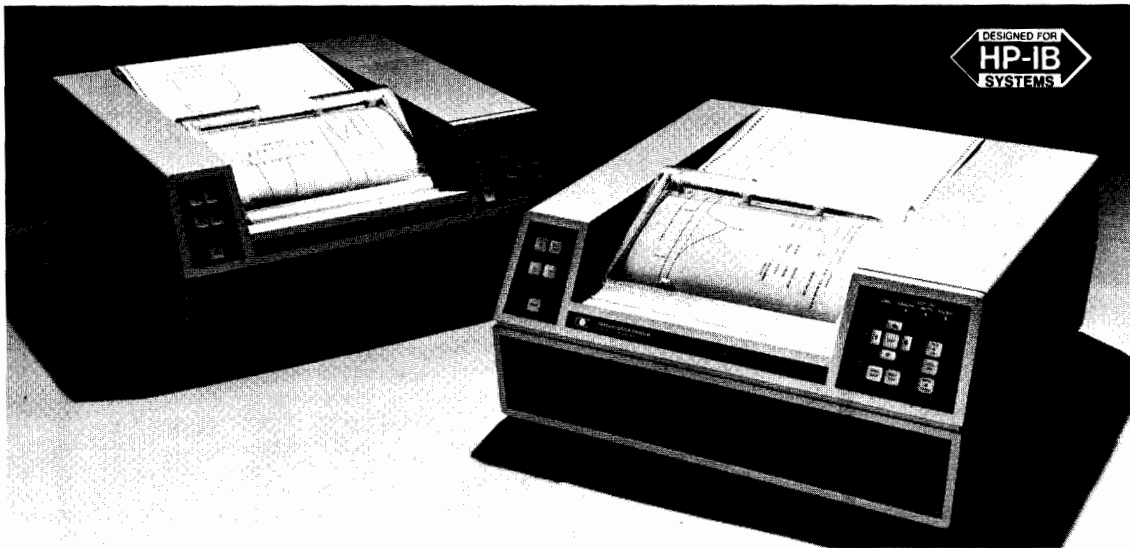

7240A

7245B

The HP 7240A and 7245B thermal plotter/printers are compact desktop units that produce high quality graphics and fast clean text on the same page. Designed for quiet in-office use or rugged laboratory conditions, these plotter/printers are ideal peripherals to produce professional documentation for engineering, scientific, financial, and business use. Either unit can draw plots with one axis up to 5 metres (16.4 feet) long; produce unattended graphics and text; and draw circles and arcs with a single command. Both units have the sophisticated HP thin-film print head and soft-platen writing surface that produce page after page of sharp, high-contrast text and graphics documentation on black or blue-trace thermal paper.

The 7240A and 7245B accept over 55 Hewlett-Packard Graphics Language (HP-GL) plotter commands, plus over 41 printer commands to simplify the generation of complex graphics and formatted text. The plotter commands produce both basic and enhanced graphics, so even the new user can start to draw vector plots with labels, pie charts, and bar graphs. Print commands can format the text; set up tables; and print a selection of character sets, including a number of special characters, to produce documentation in many languages. With all these capabilities, users can generate formatted pages with text and graphics to provide professional quality documents, without cutting and pasting.

The design of the 7240A and 7245B also provides an excellent selection of front and rear panel pushbuttons, switches, and indicator lights that further simplify operation. For example, pushbuttons can be used to set scaling points and left margin; move paper; turn on and off the print head; and add control characters and escape sequences to program listings for faster debugging. Switches can be used to set the number of lines per inch for text, paper length, and scaling mode. Indicator lights alert the user to error conditions, and paper and plotting limits. Both units have a user-activated Confidence Test that checks both the electronic and mechanical operation.

ISPP (17580A), HP's Industry Standard Plotting Package, supports the 7240A and 7245B plotters. Refer to page 694 for ordering information.

The 7240A Differences Explained

The 7240A is designed with an EIA RS-232-C (CCITT V.24) asynchronous serial ASCII interface. Baud rate is user-selectable from 75 through 2400 and there is a 1236-character input buffer. This model is ideal for use with a modem for remote computer systems or in a hardwired configuration with an in-house computer system or with a RS-232-C (CCITT V.24) desktop computer.

The 7245B Differences Explained

The 7245B is designed with a Hewlett-Packard Interface Bus (HP-IB) that conforms to ANSI-IEEE Standard 488-1978: SH1, AH1, T2, L1, SR1, RL0, PP2, DC1, DT0. This model is a highly useful peripheral for computer, desktop computer, and microprocessor-based systems with HP-IB or other interfaces that are compatible with the ANSI/IEEE 488 specification. With this interface, the 7245B has a selection of up to 30 unique addresses and a Listen-only switch to allow a group of 7245B units to accept commands individually, or as a group, from a single controller. In addition to the plotting and printing features available on the 7240A, the 7245B has a raster graphics image printing capability that can be used with HP graphics terminals and a 132-column condensed character set.

Specifications

Plotting/printing sizes (maximum): 188 mm x 5 m (7.4 in. x 16.4 ft) with full paper return; 188 mm x 61 m (7.4 in. x 200 ft) without full paper return

Perforated page sizes: English—216 x 279 mm (8.5 x 11 in.); metric—210 x 298.5 mm (8.3 x 11.75 in.)

Addressable dynamic range: $\pm 1 \times 10^{\pm 99}$ scaled units

Plotting accuracy: $\pm 0.2\%$ of deflection ± 0.35 mm (± 0.014 in.). Includes linearity and repeatability

Repeatability: 0.25 mm (0.01 in.) from any given point

Motor resolution: 0.016 mm (0.0006 in.)

Maximum plotting speed: Pen-off velocity—513 mm/s (20.2 in./s)—in either axis and 725 mm/s (28.6 in./s) at 45° angle. Pen-on velocity—256 mm/s (10.1 in./s) in either axis and 363 mm/s (14.3 in./s) at 45° angle. Selectable from 10 to 480 mm/s (0.39 to 18.9 in./s)

Print head positioning: Arrow pushbuttons—6.1 mm/s (0.24 in./s). Arrow and Fast pushbuttons—95.5 mm/s (3.76 in./s)

Power requirements: 100V, 120V, 220V, 240V -10% +5% 300 W maximum

Environmental range: Temperature—0 to 55°C. Relative humidity—5 to 95% (below 40°C)

Dimensions: 201 mm (7.9 in.) H x 442 mm (17.4 in.) W x 483 mm (19 in.) D. Net weight—19.1 kg (42 lb)

Accessories and Supplies

Refer to the HP Computer Supplies Catalog (5953-2450) for ordering information.

Ordering Information

7240A Thermal Plotter/Printer

7245B Plotter/Printer

OEM discounts available.

Price

\$6,200

\$6,200

COMPUTERS, PERIPHERALS & CALCULATORS

Overhead Transparency Kit, Graphics Software

Models 17055A, 17580A, 72021C

- Transparencies with 7 vivid colors
- Normal & broad stroke transparency pens

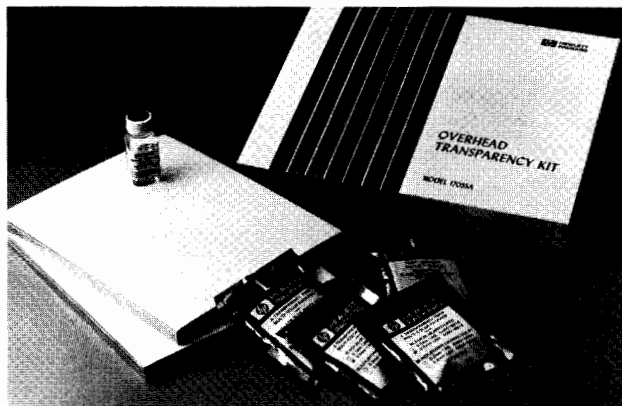

17055A

Overhead transparency kit

The HP Overhead Transparency Kit contains all the supplies necessary to prepare up to 200 transparencies 216 x 267 mm (8½ x 10½ in.) on the HP graphics plotters 7220, 7221, 9872 and 7225 with velocity select capability and a 17601A, 17603A or 17604A Personality Module. With this kit, graphics can be made at a price significantly lower than usually paid to outside vendors.

The Kit contains 16 pens in two pen widths: regular (approximately 0.3 mm) and broad (approximately 0.6 mm). The colors in each width are black, red, green, blue, violet, orange, and brown. The ink formula was created specifically to adhere firmly to the plastic film surface; dry to a hard finish in minutes at temperatures of 20°C and above; and maintain vivid hues when projected.

The 200 transparent sheets of plastic film are packaged in lots of 100 with protective paper between each sheet. The protective paper can be used to shield the charting surface of the film from scratches and body oil deposits. This is done by simply leaving the paper on top of the film until it is held firmly by the plotter's electrostatic hold-down mechanism.

Overhead transparencies can be drawn with the same programs used to prepare graphics on chart paper. The finished transparency can have clean color lines, filled-in blocks of color, or both. However it is drawn, the completed transparency is virtually smearproof, providing professional graphics for use after use.

The contents of the Overhead Transparency Kit are packaged in a clean-line, durable box that can be stored vertically or flat. Each box includes step-by-step instructions, plus part numbers for reordering separate items as needed.

Supplies Provided

Description	Part no.
4-pen package: Black, red, blue, green; regular tip	5060-6818
4-pen package: Black, orange, brown, violet; regular tip	5060-6834
4-pen package: Black, red, blue, green; broad tip	5060-6819
4-pen package: Black, orange, brown, violet; broad tip	5060-6835
Solvent: 29.6 ml (1 fl oz)	5060-6828
Transparency film: Two 100-sheet packages of transparency film (order in packages of 100)	9270-0639

Ordering Information

Model	Price
17055A Overhead Transparency Kit	\$125

Graphics Software Packages

Two user-oriented graphics software packages are available to minimize the effort required to develop simple or complex data plots on any of Hewlett-Packard's graphics plotters with RS-232-C or HP-IB interface. Both software packages are written entirely in ANSI Standard FORTRAN (X3.9-1966). They are supplied in source language form either on magnetic tape or flexible diskette

format depending on the option specified. Each package permits simple installation on almost any ASCII-based computer system.

17580A—Industry Standard Plotting Package "ISPP"

HP-ISPP's thirteen user-accessible subroutines support all HP-GL graphic plotters—7220A/S/C/T, 7240A, 7245B, 7580A, 9872B/S/C/T, and 7225A/B with 17601A, 17603A, or 17604A personality modules. ISPP subroutines are very similar to existing industry plotting subroutines and permit users to support an HP plotter on existing applications software with only minor modifications. Some of the features which make ISPP an excellent tool for data plotting are listed below.

ISPP Features

- Scales user data to fit on a graph of a given size
- Draws and annotates axes for a graph
- Optionally generates special centered characters at data points
- Draws symbol strings at various angles and sizes
- Scales the plot larger or smaller

72021C—HP-PLOT/21

HP-PLOT/21 is a set of seventy-seven user-accessible graphics subroutines that support the 7221B/S/C/T compacted binary language plotters. In addition to providing the features listed below, HP-PLOT/21 utilizes the powerful intelligence of the 7221 series plotters to provide single-command arc and circle generation, programmable line types, special symbols, and centered markers, and programmable pen selection and velocity control.

HP-PLOT/21 Features

- Data scaling in any of four unit systems
- Automatic axis/grid positioning and plot rotation
- Area masking
- Labeling in any of six plotter-resident character sets or in four software-generated sets
- Polygon shading
- Control of paper advance capability on "S" and "T" models

Options for ISPP

Magnetic tape, 9-track, unlabeled, unblocked. ASCII character code.

Option no.	Description	Price
001	800 CPI, 72 byte fixed-length records	N/C
002	1600 CPI, 72 byte fixed-length records	N/C

Flexible diskette

003	Format compatible with Digital Equipment Corporation RX01 or RX02 dual drive	N/C
-----	--	-----

Options for HP-PLOT/21

Magnetic tape, 9-track, unlabeled, unblocked. ASCII character code.

Option no.	Description	Price
001	800 CPI, 72 byte fixed-length records	N/C
002	1600 CPI, 72 byte fixed-length records	N/C
008	800 CPI, 512 byte fixed-length records in Digital Equipment Corporation DOS format	N/C

009	1600 CPI, 512 byte fixed-length records in Digital Equipment Corporation DOS format	N/C
-----	---	-----

Flexible diskette

010	Format compatible with Digital Equipment Corporation RX01 or RX02 dual drive. Two source discs and one compiled, ready-to-use library disc for RT-11 V03 operating system	N/C
030	Double-sided, double-density, for use on HP 300 computer system	N/C

Ordering Information

Model	Price
17580A ISPP Software	\$200
72021C HP-PLOT/21 Software	\$500



The quality of supplies used in Hewlett-Packard computer products not only affects operating performance, but also product life and reliability. For example, the rate of wear on thermal print heads is directly related to contact abrasion with the paper used. Therefore, HP carefully selects and tests thermal papers to help ensure that the correct paper is used to promote the longest possible print head life. High performance products such as HP disc drives have an even more critical interrelationship with their operating supplies (disc cartridges and disc packs).

HP Disc Media

Every rigid disc pack and cartridge is 100% tested and certified for use on HP drives. The packs are dynamically tested to reduce surface imperfections or imbalances and electromagnetically tested to reduce data transfer errors. Total disc drive performance and the drive head/media interface are uniquely interdependent, therefore, disc drive specifications and reliability can be assured only when using HP media products. Flexible disc media are also manufactured and tested to meet HP's rigid standards. These standards ensure that optimum match

between the media and head is obtained for longest possible life.

Mini Data Cartridge

Hewlett-Packard is the only computer and peripheral manufacturer that makes its own minicartridges for terminals and desktop computers. Since the manufacturing processes and the materials are closely controlled, the result is a quality data storage device which enables the best product performance. Every cartridge is 100% tested for mechanical and electrical performance after it has been aged.

Furniture

Along with quality supplies, HP offers convenient storage cabinets and other furniture items for your media, documentation and equipment. The cabinets and storage products are optimized for the broadest range of requirements and are the result of consultation with many HP users—ranging from those with smaller desktop computers and related systems to those with complete HP 3000 computer installations. Workstation furniture offering a variety of features is also available. Due to modular design, it provides a means of composing an attractive and comfortable work environment to complement

your HP systems configuration. Mobile units and HP designed tables are available to provide a place for terminals, printers and plotters.

Cables and Other Accessories

HP-IB (IEEE 488) cables, RS-232C cables for HP terminals and kits to help you make your own connections are available. Other accessories offered include static control mats, media desktop storage items and sound absorbing products for your HP printers.

Catalog Available

To help you in selecting the HP supplies, accessories and software necessary for operation of your system, ask your local HP sales office for publication number 5953-2450, the *HP Computer Users* catalog. It contains information on all HP supply items plus much more. Easy ordering and timely shipments from stock in our distribution center as well as toll-free direct phone ordering in the U.S. and Germany are some of the services available through the catalog. If you prefer to request a copy directly, please write to: Hewlett-Packard, Computer Supplies Operation, P. O. Box 60008, Sunnyvale, Ca 94088.



COMPUTERS, PERIPHERALS & CALCULATORS

Computer Support

Overview/Software Training and Consulting

- Assured lasting value for your HP computer products
- Broad range of services worldwide



Overview

HP's support services ensure the lasting value of your HP computer products. Throughout their lifetime, your HP products will be maintained to meet their performance specifications. More important, training, consulting, and ongoing user support will help you make your HP products an answer to your application needs. In short, HP support services provide the resources you need to use your products successfully.

Cost effective: customers can tailor the most effective support program for the lowest cost using HP's broad range of support services.

Compare the performance features of HP's support programs to your cost as a percentage of the equipment's list price. Or calculate your five year cost-of-ownership, including hardware, software, and support costs. You'll find HP ranks well against the competition in both areas.

New service programs: our goal is to introduce innovative support services which better meet customer needs. Programs like Guaranteed Uptime Service for the new HP 3000 systems and System Information Service for desktop and personal computers are examples of HP's leadership in providing effective support solutions.

Lasting value: for services to provide lasting value, they must consistently meet or exceed customer expectations. How do customers rate HP support? In 1981, a major survey asked over 2,000 customers to rate systems and service from 28 minicomputer vendors. For statistically significant responses, HP maintenance services and mainframe reliability both received the highest ratings in the survey.

Consistent support worldwide: specified services ensure that you receive consistent support no matter which HP office provides the services, no matter where their location. Customers receive a detailed set of specifications for every service purchased. You can clearly understand what to expect from HP's support programs.

- Expert instruction from the company who designed and built your system
- Specialized solutions for planning and integrating systems

Software Training and Consulting

Today's capable software systems require training and expert consulting in order to be used most effectively. HP training courses enable users to better understand the system, its utilization, and capabilities. This instruction can improve their productivity and significantly reduce implementation time.

To aid in planning and installing a complete computer system, HP makes available the consulting services of an experienced HP Systems Engineer (SE). The SE can offer suggestions for enhancements, new uses for your specific application, and recommendations for improving efficiency of operation. Skilled advance planning means good integration of product with application and ensures early end user satisfaction.

Software Training—Proficiency for Users and Programmers

HP offers training courses to instruct users in the theory and operation of HP software so that they can more fully and effectively utilize their systems. This training includes a full complement of standard courses which range from introductory to advanced levels and emphasize both lecture and laboratory.

Regularly scheduled courses are offered at well-equipped training centers in most area sales offices. Companies with large programming staffs may find optional, on-site courses a cost-effective alternative. In addition, self-paced courses have been developed for the HP 3000 which provide low-cost instructional material on selected topics.

Ordering Information

Consult a customer training schedule for information on course price and availability. Or call your local HP sales office or sales representative.

Consulting Services—Specialized Assistance

Consulting is a service delivered by a Systems Engineer, customized to your specific application and needs. It can range from helping you personalize HP training course material to your specific application; to developing techniques for addressing a unique or complex problem; to troubleshooting a system.

Consulting services are not a substitute for training, but rather a technical resource to augment the knowledge a customer gains from standard training programs. Two types of consulting services are available: unstructured assistance billed on a daily basis and standardized consulting services. Standard programs include commonly requested tasks for a fixed duration and price.

Ordering Information

You may request consulting from the nearest HP sales office or by conferring with your HP sales representative or an HP systems engineer. Charges for consulting are invoiced upon completion of the service or at the close of each calendar month if the service period extends beyond one month.



- Contracts to support desktop and systems owners
- Up-to-date information for managers, operators, programmers
- Flexible options to suit your budget

Benefit	Feature	CSS	SIS	SSS	SNS	MUS
Personal assistance	Account-Assigned SE	•				
	On-Site SE Assistance	•				
	PICS	•	•			
Software updating & Maintenance	Software/Firmware Updates	•		•		
	Software Problem Reporting	•	•	•		
Application notes & tips	<i>Communicator</i>	•	•	•	•	
Status and documentation updates	Software Status Bulletin	•	•	•	•	
	Software Update Notice (HP 1000)	•		•	•	
	Manual Updates	•	•	•		•

Figure 1: Contractual Software Support

Software Support Programs—Personalized Assistance for Your Staff

Not only does HP help you get started using your equipment; contractual services are available to answer your questions speedily in the months that follow. Other forms of software assistance, such as manual and software updates, are also conveniently packaged into contractual services. The variety of standardized services allows you to choose the level of support you need for continuing efficient operation.

Customer Support Service—Comprehensive Systems Support

HP systems software support begins even before the computer is ordered. During the selection process, a Systems Engineer (SE) provides technical advice to make sure the system, software products, and support will fit your business needs both current and future.

After you purchase Customer Support Service (CSS), an HP Systems Engineer is assigned to your account to help you with applications software development, resolve any software bugs and discrepancies, and preview new and enhanced HP software for your potential use. SE assistance is available to you via both a Phone-In Consulting Service (PICS) and on-site assistance.

In addition to valuable, personalized assistance from your SE, the CSS program includes one copy of HP software/firmware updates, plus updates and revisions for your HP software reference manuals. Periodic bulletins and newsletters provide information on current software problem reports and their solutions; plus operational tips, programming techniques, and items of general interest. These publications include:

- HP COMMUNICATOR—four times per year
- SOFTWARE STATUS BULLETIN—twice monthly, plus a cumulative quarterly issue
- SOFTWARE UPDATE NOTICE—quarterly, to HP 1000 customers

System Information Service—Ongoing Support for Desktop and Personal Computer Users

System Information Service (SIS) is a software and firmware support service especially designed for owners of desktop and personal computers. It provides the technical and applications assistance needed by users and programmers for the effective and productive use of their HP computers. Early proficiency and confidence, during the first months of operation, can mean increased productivity and efficiency. Features of SIS include:

- Phone-In Consulting Service (PICS)
- Software Problem Reporting
- COMMUNICATOR
- Software Status Bulletin
- Manual Updates

With SIS, you can use the Phone-In Consulting Service to request telephone assistance regarding technical difficulties you may encounter in using HP software products. Hewlett-Packard assures a response to your phone call within four hours, by a skilled technical specialist. Call-in hours are from 8:00 AM to 5:00 PM, for the nearest PICS center (excluding HP holidays).

Software Subscription Service—For Self-Support Customers

If you have an application which changes little over time, the Software Subscription Service (SSS) provides all software and documentation described under the CSS. SSS includes the following features:

- Software/Firmware Updates
- Software Problem Reporting
- Software Status Bulletin
- COMMUNICATOR
- Manual Updates

A customer who selects SSS can use consulting services for supplemental assistance from a Systems Engineer.

Software Notification Service and Manual Update Service—Documentation for a Large Staff

Routinely available in both CSS and SSS described above, the Software Notification Service (SNS) is also available separately. If you have a large programming staff or multiple sites, SNS allows you to obtain multiple copies of periodic HP documentation.

Large programming staffs also frequently require multiple copies of manuals. Manual Update Service (MUS) is a valuable supplement to both CSS and SSS, since it relieves customers of the administrative burden of monitoring and ordering manual updates.

Ordering Information

Software support services are normally purchased for a 12-month period, payable in advance, quarterly, or yearly as desired. The minimum purchase is three months. SNS and MUS are each purchased separately for a period of 12 months, renewable annually. Detailed ordering information can be obtained from an HP Sales Representative or by referring to the appropriate HP Computer System Price/Configuration Guide.



- Cost-effective maintenance agreements
- Flexible options for desktops and systems
- Installation services

Contractual Hardware Services—Maximize Performance and Lower Ownership Costs.

With Hewlett-Packard service plans your equipment is kept in top working condition by HP-trained customer engineers. Service coverage hours and response times can be selected to fit your business needs, including budget as well as time requirements.

There are HP service plans which provide fast, convenient on-site service. If your business requires it, seven-days-per-week 24-hour coverage can be purchased for computer systems. Maintenance costs can be controlled with lower priced plans, which permit skilled service and turnaround within a few days at an HP Field Service Center. In either case, budget planning is facilitated by consistent monthly, quarterly, or annual payments.

Feature	Guaranteed Uptime	Standard	Basic	On-Site Product	FRC
Monthly Maintenance Charge	GMMC	SMMC	BMMC	PMMC	FMCC
Response Time	4 hrs.	4 hrs.	Next day	Next day	3-day TA
Coverage Hours	8am-8am	8am-9pm	8am-5pm	8am-5pm	8am-5pm
Account-Assigned CE	•	•	•		
Scheduled PMs & ECs	•	•	•		
Work-to-Completion	•	•	•		
Add-on Installation	•	•	•		
Site Environmental Survey	•	•	•		
Extended Coverage Hours	N/A	•			
Guaranteed Uptime	•				

Figure 2: Hardware Maintenance Agreements Summary

On-Site Product Service—Fast and Convenient Workstation Maintenance

The On-Site Product Service is an economical on-site support service ideal for customers who purchase desktop computers or have several terminals or desktop printers connected to their systems. Products placed under On-Site Product Service are maintained for about one-third less than under a Standard Systems Service.

A product-specialized Customer Engineer will respond to your service call by the next working day if you are located within 100 miles of an HP service office. On-site service is provided beyond 100 miles with an increase in response time and cost. Specific hours of coverage are from 8 AM to 5 PM, Monday through Friday (excluding HP holidays).

Field Repair Center Service—Economical Maintenance Insurance for Standalone Workstations

The Field Repair Center (FRC) Service is the lowest price hardware service for HP computer products (about half as much as on-site service). Remedial repairs for desktop computers, terminals, desktop printers, and plotters are performed by a product-specialized Customer Engineer at the local field repair center.

This service is ideal for customers who can operate without a unit for one to two weeks, or who have spare or redundant units available as backups. It is preferable to per-incident charges, because HP covers all hardware problems resulting from normal product use for a low monthly fee; insuring you against expensive maintenance "surprises" after the 90-day warranty period.

Eligible products are shipped to the local FRC by the customer. They are repaired with three working days and returned via normal land freight by HP.

System Maintenance Services—Customer Engineer Personally Responsible to Your Account

When you purchase an HP Systems Maintenance Agreement, a Customer Engineer is personally assigned to your account. When your system requires service, your CE will respond within the length of time designated on your support contract. And the CE will stay on the job until your system is restored to normal operation, regardless of the coverage hours of your agreement.

On a scheduled basis, your Customer Engineer will visit your site and run diagnostic tests on your system. If a potential problem is discovered, your CE will make the necessary adjustments and replace any worn parts.

Levels of system maintenance vary with the application needs of the customer. The variables are cost, hours of coverage, and CE response time.

The "Guaranteed Uptime Service" is designed for customers who need a very high level of system availability. It ensures 99% uptime on system critical elements (or money refunded), on-site maintenance services, and round-the-clock continuous coverage. It is currently only available for the new HP 3000 systems.

The "Standard System Maintenance Agreement" provides coverage from 8:00 AM to 9:00 PM Monday through Friday. This coverage allows all scheduled maintenance services to be performed after normal working hours. For customers located within 100 miles of a Service Responsible Office, same-day response is assured if customer requests are received during a normal 8 a.m. to 5 p.m. shift.

For minimal interruption to your operations, you can increase the hours of coverage up to 24 hours a day, seven days a week. Extended coverage can be tailored to the requirements of critical system uses.

A "Basic System Maintenance Agreement" plan provides economical coverage from 8:00 AM to 5:00 PM Monday through Friday. Next-day response is assured to customer requests for service if customers are located within 100 miles of a Service Responsible Office.

"Out-of-Coverage Service" provides 24 hours per day, seven days a week access to the HP Computer Support organization, on occasion, for phone consultation or on-site assistance outside the coverage specified by your maintenance contract.

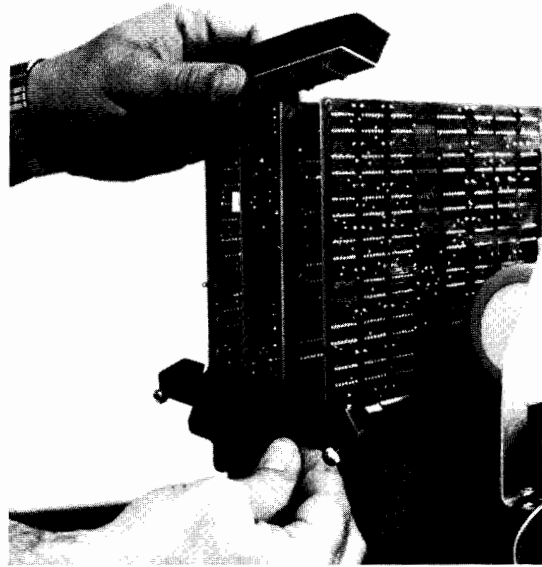
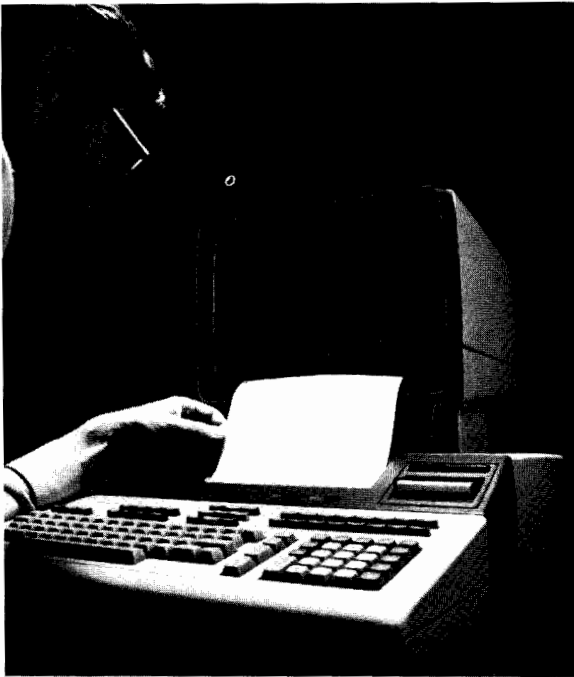

HP 35030A Power Line Conditioner

Systems Installation Services

For systems customers, field engineering services begin even before your system is installed. A Customer Engineer routinely provides site planning, site environmental survey, and installation services. These services ensure that your HP computer system is installed properly at an acceptable, designated site.

The site survey may indicate a need for regulation of the power source. HP markets a power treatment device applicable to many such sites (described below).

Power Line Conditioner

For protection from power disturbances during computer operation, the Computer Support Division markets the HP 35030A power line conditioner. It attenuates noise and compensates for fluctuations of voltage on the power line; these combined functions protect against 99% of typical power line disturbances. Easily installed, the PLC is recommended for protection against downtime in older buildings and areas where electrical storms occur.

Price
\$1050

Optional Time and Materials/Standard Repair Service —Per-Incident Maintenance

For customers not using contractual maintenance services, hardware support is available on a "Time and Materials" basis. Customers purchasing T&M Services receive a three-day response during coverage hours of 8:00 AM–5:00 PM Monday through Friday. The customer is billed for all travel, parts and labor used during the service call.

If the computer product is sent to a Field Repair Center, "Standard Repair" (STREP) charges are defined for per-incident service. STREP charges are also available for on-site service (parts and labor) with additional charges for CE travel time. STREP charges can help control T&M maintenance costs because the repair charge is preset for many products, regardless of parts and labor used in your particular incident.

Self Support—Maintenance Training and Hardware Exchange

While self support is expensive, customers with a very large base of installed HP equipment and a staff of proficient engineers may find it cost-effective. In countries with no HP presence, it may be the only alternative.

Maintenance training courses are available from HP for desktop computers, HP 1000 computers, and some peripherals. They are taught in Cupertino and Grenoble; or the customer may opt for on-site training.

HP also provides Self Support customers with an assembly exchange service, tools, and parts.

Ordering Information

You may procure a Maintenance Agreement by contacting your HP Sales Representative of your nearest HP computer systems Service Responsible Office (see list at the back of this catalog).

Invoices will be submitted monthly, quarterly, or annually in advance at your option. Invoices for services provided which are not included in the agreement will be submitted at the time they are performed.

Warranty Services—90-Day Coverage

HP warrants its computer products against defects in materials and workmanship for a period of 90 days. (For more information on the HP warranty, see the "Post-Sale Support Service" section of this catalog.)

HP Service Locations Worldwide

HP maintains computer sales and support offices in 39 countries. For a listing of addresses, see the back of this catalog.

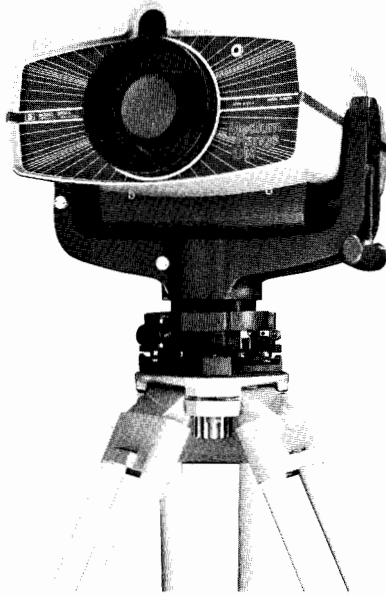

HP 3808A Medium Range Distance Meter

Hewlett-Packard, long recognized as the leading supplier of electronic measuring and computing instruments for the engineer, has developed a similar position in electronic distance/angle measurement and computation instrumentation for the surveyor. These instruments are briefly described on this page.

HP 3808A Medium Range Distance Meter

The HP 3808A Distance Meter is a medium range, one-push button, slope distance instrument with a range of 10 km (6.25 miles) to two triple prism retro-reflector assemblies.

The HP 3808A is designed for surveyors to use in applications such as land, construction, and control surveys; as well as precise traversing, photo control, structural monitoring, and land slip studies. In addition, its versatility will allow its use in many other applications, such as precision control of industrial fabrication operations, and other areas where the measurement of distance is critical. The HP 3808A features digital input and output capability allowing simple control and recording of distance meter results. When properly interfaced, the distance meter can be controlled remotely by simple calculators or complex computers. This feature enables automatic distance monitoring to be achieved.

Measured distance may be displayed in either metres or feet (switch selectable). A "tracking" mode permits continuous updating of distances or return signal strengths. Target acquisition is facilitated by an audio aiming feature.

A number of special accessories and options are available for the HP 3808A to enhance its performance in surveying, monitoring, and industrial control applications.

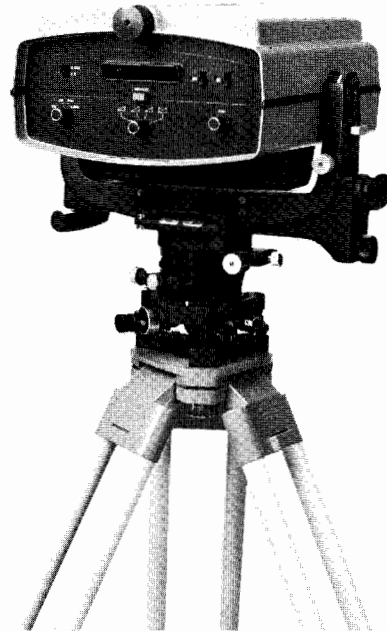

HP 3810B Medium Range Total Station

HP 3810B Medium Range Total Station

The HP 3810B Medium Range Total Station is an automatic, direct reading, electro-optical distance and angle measuring instrument utilizing an infrared light source. The range of the HP 3810B is 8 km (5 miles) with the measured distance displayed in metres or feet and angles displayed in degrees or grads. The key to the Medium Range Total Station's power is a built-in microcomputer and a vertical angle sensing device. The instrument has the ability to measure the slope distance, zenith angle, correct for curvature and refraction, and automatically compute and display the horizontal distance. Four parameters are selectable for display: zenith angle, slope distance, horizontal distance, and vertical distance. The communicative display indicates the quality of the measurement, on target indication, and notifies the operator of a low battery. Horizontal angle measurements are made with the 20 second or 50^{cc} least count horizontal angle base with estimation to 5 seconds or 10^{cc} on the micrometer scale. The HP 3810B also features a built-in atmospheric correction to 1 part per million, a snap-in battery, and a "tracking" mode for rapid point setting to one-hundredth of a foot with updated measurements every two seconds. Precise measurements to three-thousandths of a foot can be made in approximately nine seconds.

HP 3820A Electronic Total Station

The HP 3820A Electronic Total Station is a medium range, automatic, direct reading, electro-optical distance and angle measuring device utilizing a laser diode light source. Solid state electronics gives the HP 3820A its high accuracy plus a range of 5 km (3+ miles) which means long shots can be made without intermediate set ups. The operator, by merely pressing a button, can electroni-

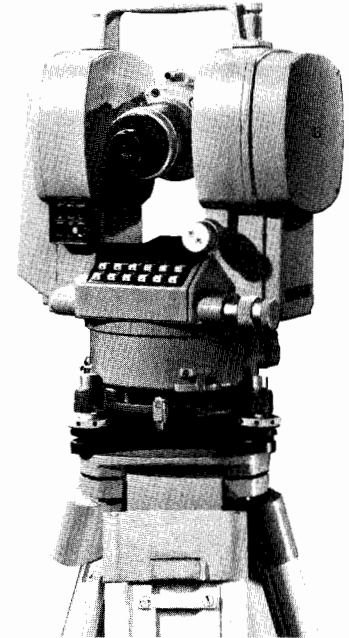

HP 3820A Electronic Total Station

cally display both horizontal and zenith angles to one second. Both horizontal and zenith angles are automatically dual-axis compensated for instrument mislevel—an HP exclusive. The instrument also displays relative direction—that is—the clockwise angle from the previous direction to the current direction. In addition to angle measuring capability, the HP 3820A has the ability to measure slope distance, zenith angle, and automatically compute and display horizontal distance. Vertical distance and slope distance can also be displayed at the touch of a button. The HP 3820A features a built-in atmospheric correction to one part per million plus a snap-in battery pod that fits into the instrument's left standard for a lightweight, compact, easy to use field instrument. A built-in output plug allows the operator to electronically transfer any of its measured components to an external Data Collector or calculator.

Versatility and Simplicity

Hewlett-Packard's versatile Distance Meters and Total Stations are suited for such applications as geophysical, layout, location, boundary, hydrographic, topographic, control, and mine surveys. A short demonstration is all that is necessary for operator training on these instruments.

Surveying Calculators

The Civil Engineering Division also markets Hewlett-Packard's line of desk top computers and peripherals filling the surveyor's requirements for distance/angle measurements and computation instrumentation. Application and programming specialists have developed libraries of surveying programs for these systems.

For detailed specifications and prices on these instruments and optional accessories, contact the Civil Engineering Division, P.O. Box 301, Loveland, Colorado 80537.

DISTANCE MONITORING AND CONTROL EQUIPMENT

Industrial Distance Meter
Model 3850A

701



- Non-contact measurement—replaces mechanical measurement systems
- Distance and time data—allowing velocity and acceleration computations
- Universal proportional control software—enables optimum close loop position control

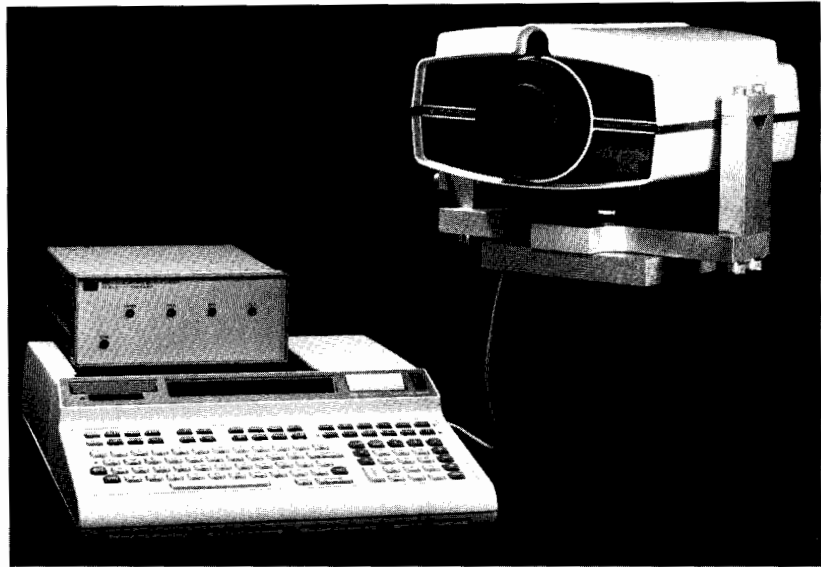

Telemechanical Measurements

The 3850A Industrial Distance Meter outputs accurate distance and time data from a reflecting target mounted to an object. Non-contact measurement eliminates the design, installation, and maintenance required by mechanical measuring systems.

Monitoring

Utilizing optical contact, the 3850A is useful in monitoring objects which may move only millimeters (hundredths of an inch) at a time. The 3850A may be used at a remote location to provide input to alarms and/or corrective action when unwanted movement occurs.

Close Loop Positioning of Dynamic Objects

Combined with a controller and HP's proportional control software, the 3850A enables critically damped positioning of any size object.

Tracking

The 3850A Industrial Distance Meter is a powerful tool for tracking a wide array of objects. Combined with a controller, the information can be formatted as distance/velocity/acceleration plots. Typical applications include the tracking of ships, automobiles, and aircraft.

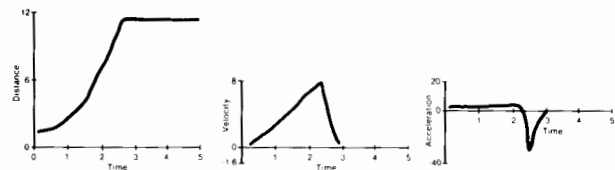

Length

The 3850A Industrial Distance Meter may be used as an excellent linear measurement tool. Typical examples are measuring lengths of pipes, I-beams and steel cables in a production facility. In addition, the 3850A can be used for measurements normally made by surveyors.

Typical HP 3850A Control System

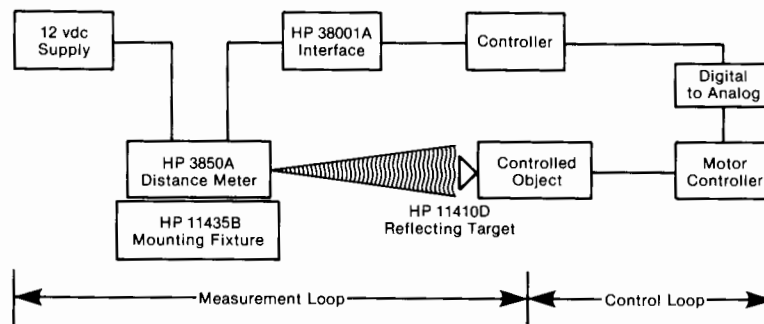

3850A Industrial Distance Meter Specifications

Range:⁽¹⁾ .5 m–8 km (1.6 ft–26,240 ft) to two triple prisms (HP 11411D)

Positional Accuracy (RMS):⁽²⁾ $\pm(5 \text{ mm} + 1 \text{ mm/km})$ or $\pm(0.20 \text{ in} + 0.06 \text{ in/mi})$

Positional Repeatability (RMS): $\pm 1 \text{ mm}$ ($\pm 0.04 \text{ in}$)

Velocity Range: 0–40 m/s (0–133 ft/sec)

Velocity Accuracy (RMS): $\pm 0.05 \text{ m/s}$ ($\pm 0.167 \text{ ft/sec}$)

⁽¹⁾ Other reflectors available with decreased range capabilities

⁽²⁾ Accuracy can be improved by controlling specific environmental parameters.

Ordering Information

HP 3850A Industrial Distance Meter	\$14,500
HP 38001A HP-IB Distance Meter Interface	\$1,850
HP 11435B Industrial Mounting Fixture	\$595
HP 11410D Single Prism Retro-Reflector Assembly	\$295
HP 38050A Industrial Distance Meter Software and Documentation	\$800

Price

HP 3850A Industrial Distance Meter	\$14,500
HP 38001A HP-IB Distance Meter Interface	\$1,850
HP 11435B Industrial Mounting Fixture	\$595
HP 11410D Single Prism Retro-Reflector Assembly	\$295
HP 38050A Industrial Distance Meter Software and Documentation	\$800

DIMENSIONAL INSPECTION EQUIPMENT

Coordinate Determination System

Model 3822A

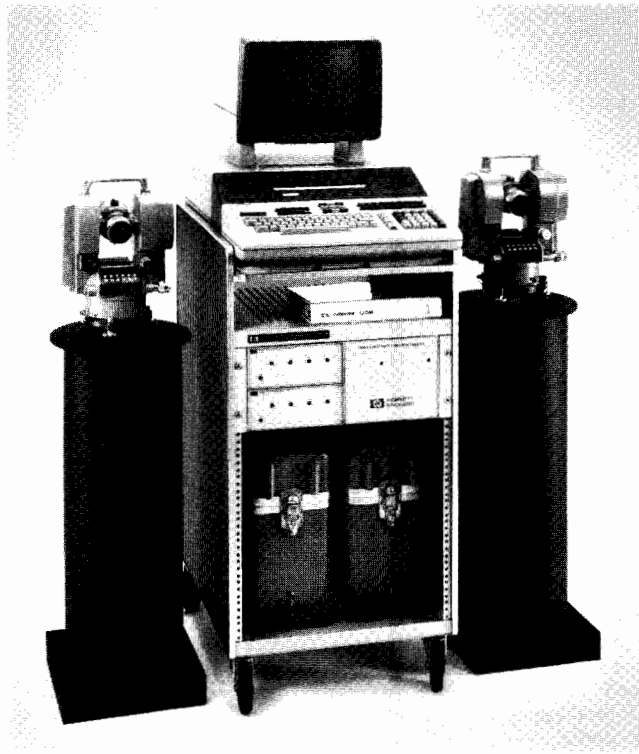

HP 3822A Coordinate Determination System

Description

The 3822A Coordinate Determination System provides accurate, non-contact measurement, with a repeatability of 1:165 000, to a variety of objects. Designed to be portable, the 3822A may be transported quickly and easily to the object to be measured, thus eliminating the need to move large objects to a coordinate measuring machine.

The 3822A Coordinate Determination System requires operator aiming of two 3820A Electronic Total Stations (digital theodolites) to a target point. The 9845T System Computer then automatically reads the instrument angles, translates the spherical angle information into X, Y, and Z coordinates, and prints the results along with system status information. The time tested methodology, based on triangulation, is combined with electronic digital theodolites and a powerful system computer resulting in a measurement tool designed to solve difficult coordinate determination equations and display virtually instantaneous results.

Equipment

The 3822A Coordinate Determination System uses two 3820A Electronic Total Stations (digital theodolites) as the angle measuring instruments. The electronic sophistication of the 3820A provides 1⁰⁰ grad (0.3 arc second) resolution at speeds of more than 100 points per hour. The angle data collected by the digital theodolites is automatically transferred to a 9845B System Computer. The 9845B was selected due to its ease of programming, large memory, graphics capability, and available accessories. The special 38020A Software contains all the programs necessary to display X, Y, and Z coordinates. Power supplies, data interfaces, cables, and optical accessories are conveniently housed in a neat, highly portable transport cart.

Accuracy

In coordinate measurement, two terms are often confused with accuracy—resolution and repeatability. Resolution is a measure of how fine a graduation any measurement process will display. Repeatability is a measure of how well today's and tomorrow's measurements of the same object agree. In a triangulation based measurement process such as the 3822A Coordinate Determination System: resolution is a function of the angle instrument resolution; repeatability is a function of the angle instrument accuracy; and coordinate accuracy is a function of how well the user can provide a measured control distance.



- Large Scale Dimensioning
- Non-Contact Measurement
- Portable
- Real Time Measurements
- Accurate
- Friendly Software



To put the coordinate repeatability specification of 1:165 000 in perspective, keep in mind that steel has an expansion rate of 1:93 000 (per °C) and aluminum is even more drastic with an expansion rate of 1:42 000 (per °C). This means the 3822A Coordinate Determination System is usually more accurate than the thermal stability of the object being measured.

Software

The 38020A Software automatically steps through the coordinate measurement process prompting the novice operator on how to perform the necessary tasks. Experienced operators can bypass the sequential mode and customize their measurement procedure for maximum performance. The 38020A Software continually talks to the operator through the 9845B CRT. Messages are in plain English and instruct the user thru visual prompting.

In any measurement situation, there is always the possibility of error. The 38020A Software makes every effort possible to trap errors and give the operator an opportunity to correct them. Keyboard entry errors are trapped, and the operator is encouraged to try again. Data entry errors are also caught and an alarm is sounded. The 9845B immediately starts beeping and flashing the error message. Measurements cannot continue until the problem is cleared up, usually by reshooting the point. Even the problem of two operators aiming at different targets can be identified and is called out.

The measurement of one hundred points from two independent locations could be a confusing operation unless some method of "keeping score" is used. When shooting points, the 9845B CRT automatically "keeps score" of each operator's progress. To further simplify the process, the system software is structured so that each operator may measure at his own rate with no need to synchronize sightings. Points may even be randomly numbered from the theodolites, letting operators measure in an optimum order.

Once a given point has been observed from both 3820A's, the 9845B immediately calculates and prints an X, Y, and Z coordinate. Also printed is a number representative of how well the two 3820A's were aimed. Using this "mis-aim" number, operators can refine their technique for greatest accuracy. The printout is complete with an indication of geometrical strength for X, Y, and Z coordinates. These quantities provide the skilled user with a technique to optimize his coordinate accuracies.

HP 3822A Coordinate Determination System Block Diagram

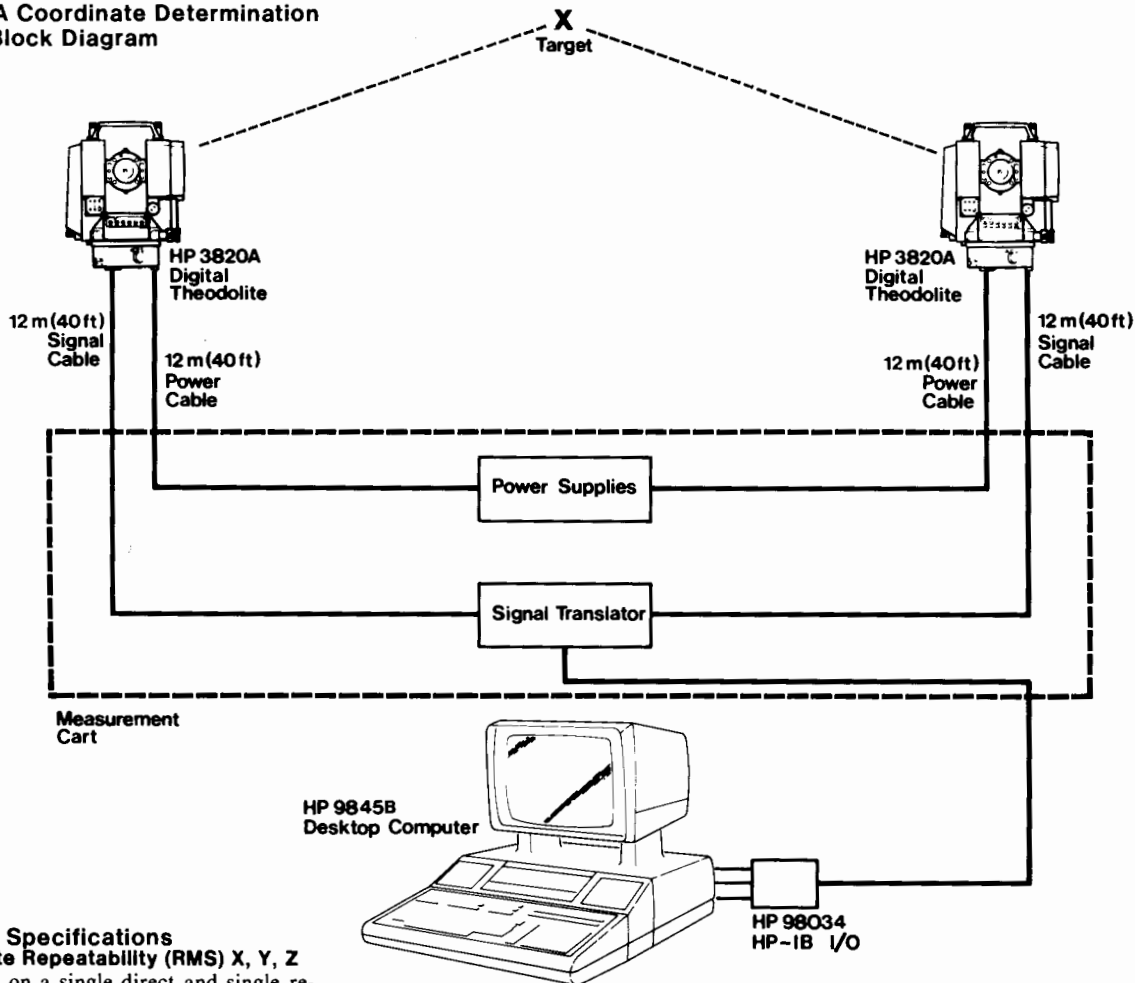

Systems Specifications

Coordinate Repeatability (RMS) X, Y, Z

Based on a single direct and single reverse sighting with HP 3820A's leveled within $\pm 33^{\circ}$ (± 10 sec). For setup with triangle strength = 1 for each dimension (X, Y, Z)

73 μ inches per foot of baseline
6 μ metres per metre of baseline
1:165 000 precision ratio of baseline

Coordinate Resolution (RMS) X, Y, Z

Based on a single direct and single reverse sighting with HP 3820A's leveled within $\pm 33^{\circ}$ (± 10 sec). For setup with triangle strength = 1 for each dimension (X, Y, Z)

Grads mode = 5 μ inches per foot of baseline
0.4 μ metres per metre of baseline
Degrees mode = 15 μ inches per foot of baseline
1.3 μ metres per metre of baseline

Rectangularity of Axes

X, Y — Absolute X, Z — 1.4 sec (RMS)
Y, Z — 1.4 sec (RMS)

Dimensions: 671 x 511 x 1581 mm (26.4 x 20.1 x 58.3 in) (HP 1117B Option C15 System Cart and HP 9845B Computer included)

Weight: 152 kg (335 lbs)

Power Requirements: 100, 120, 220, 240 volts +5%–10%, 48 to 63 Hz, 470 VA

Angle—3820A Electronic Total Station

Resolution

Grads mode: 1 $^{\circ}$
Degrees mode: 1 sec

Accuracy

RMS error of direction with telescope in direct and reversed position.
–20°C to 55°C (–5°F to 130°F)
 $\pm 6^{\circ}$ (± 2 sec) horizontal
 $\pm 12^{\circ}$ (± 4 sec) vertical

NOTE: Accuracy includes accuracy of automatic level compensator, sighting, and angle electronics

Display Rate

2.0 sec/reading—with automatic level compensation
0.5 sec/reading—without automatic level compensation

Automatic Level Compensation

Type: Dual-axis liquid surface reflection
Range: $\pm 340^{\circ}$ (± 110 sec) approximately
Use: automatically compensates horizontal and zenith angles for residual mislevel of instrument

Telescope

Focus: 2 metres (6 feet)
Power: 30 X

Computation—9845B Option 150, 312 Desktop Computer*

Features

HP enhanced BASIC language
Read/Write memory expandable from 187 146 bytes to 448 906
Typewriter-like, alphanumeric keyboard with 32 definable Special Function keys
High-resolution CRT display with 310 mm (12.3 in.) diagonal screen, 80 characters x 24 lines
Full graphics capability
–Rapid plotting on the CRT
–High level graphics language
–Hard-copy transfer to the internal thermal line printer
Two integral tape cartridge drives, each cartridge providing 217 000 byte storage capacity
Built-in 80 column thermal line printer
Complete interfacing capability with 15 assignable levels of priority interrupt plus direct memory access
Optional Read Only Memories (ROMS)

*I/O ROM required—order HP 98412A for field installation version or order HP 9845B with options 150 and 312 for factory installation of I/O ROM.

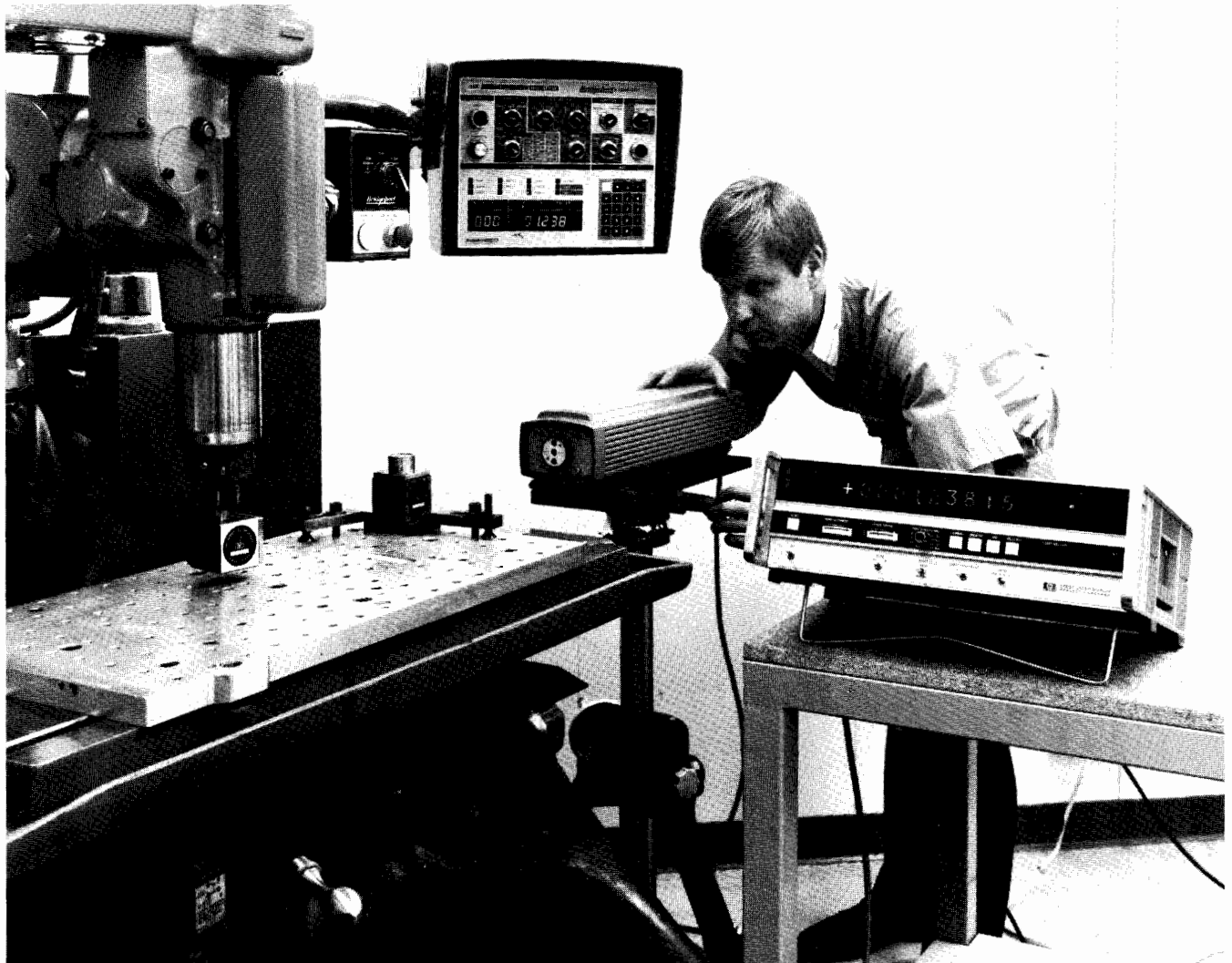

Laser Measurement

The Hewlett-Packard 5526A Laser Measurement System utilizes a precisely-known wavelength of light to provide a portable, easily used dimensional measurement tool for such parameters as length, angle, straightness, squareness and flatness.

The 5526A Laser Measurement System is used in a wide variety of applications where very accurate physical measurements are required, such as characterizing the positioning accuracy and geometry of machine tools and measuring machines.

A wide variety of output devices are available to record the measurement data including digital printers and X-Y recorders. The measurement data can be transferred directly from the Laser Measurement System to an HP desktop computer and immediately processed by prewritten metrology programs. The reduced data is then presented in either printed format or plotted to provide report-quality graphs of the measurements.

Quartz Crystal Technology

Hewlett-Packard laboratories have developed quartz crystals which respond to temperature or pressure with amazing linearity, stability, accuracy, and sensitivity. Quartz crystals resonate in electronic oscillator circuitry at a very precise frequency. Hewlett-Packard has discovered a way to produce quartz crystals whose resonant frequencies vary extremely linearly with temperature or pressure. For example, the resonant frequency of a 2804A temperature sensing crystal varies 1000 Hz (nominal) per °C. These resonant frequencies are conditioned by electronic circuitry to produce exceptionally high resolution temperature or pressure measurements.

Digital Thermometer

HP's 2804A Quartz Thermometer provides extremely precise, reliable measurements with standard resolution of 0.0001 °C over the range -80 to +250 °C. The excellent sensing characteristics of the quartz ther-

mometer are enhanced by the advantages of *direct digital readout* (no bridge balancing, or reference-to-resistance or voltage-temperature tables or curves), immunity to noise and cable resistance effects, and no requirement for external equipment such as a reference junction. Temperature can be measured up to 1.37 km (4500 feet) from the 2804A with optional amplifiers.

Quartz Pressure Probe

The Hewlett Packard 2813B Quartz Pressure Probe can detect pressure changes as small as 0.01 psi in 11,000 psia. Precision pressure measuring capability and rugged construction make the HP 2813B Quartz Pressure Probe ideal for applications requiring surface readout such as oil well logging, oceanographic research, and studies of subterranean hydrodynamics. The 2820A Pressure Recording System connects directly to the Quartz Pressure Probe. With it, pressure test data is displayed, printed and stored on magnetic tape and a strip chart.



Laser System for Dimensional Measurements

Laser Transducer for "Build-in" Applications

Model 5526A

Model 5501A

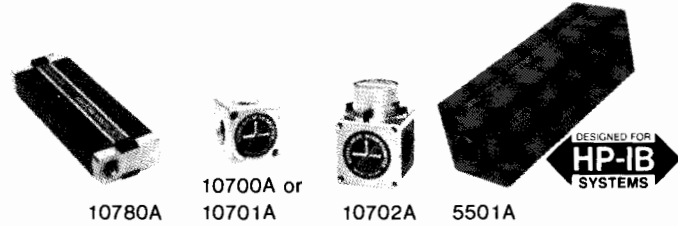
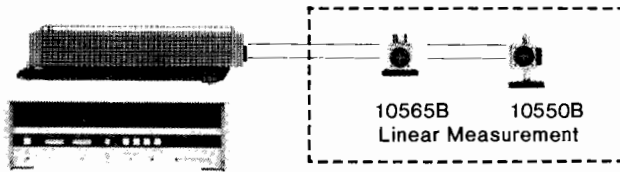

General Capabilities

The 5526A Laser Measurement System is a major advance in machine tool calibration and economical dimensional metrology. A choice of optics allows the measurement of length, angle, flatness, straightness, squareness and parallelism. In addition, measurements can be automatically printed and/or plotted.

The system is a highly accurate displacement measuring tool with a resolution of one millionth of an inch (0.01 μm) for linear measurements and 0.1 arc-second for angular measurements. Fully automatic tuning, instant warm-up and remote interferometric measurement techniques assure drift-free accuracy from the moment of switch-on.

Specifications

Laser: Helium-Neon type. Fully automatic tuning. Instant warm-up. Resolution: normal and smooth modes.

Normal: 0.1 μm . English: 0.000 01 inch. Angular: 1 arc-second.

X10: 0.01 μm . English: 0.000 001 inch. Angular: 0.1 arc-sec.

Maximum allowable signal loss: 95% (-13 dB).

Maximum measuring velocity: 18.3 m/min. (720 inch/min.)

Atmospheric and material compensation: manual input from tables. 5510A Automatic Compensator optional.

Linear Measurement

Accuracy:

Metric: ± 0.5 parts per million ± 2 count in last digit.

English: ± 0.5 parts per million ± 1 count in last digit.

Maximum measuring range: up to 60 m (200 ft) depending on conditions.

Angular/Flatness Measurement

Accuracy: ± 0.1 arc-second (± 1 count in last digit) up to 100 arc-seconds. ± 1 arc-seconds (± 1 count in last digit) up to 1000 arc-seconds. ± 4 arc-seconds per degree (± 1 count in last digit) up to ± 10 degrees using correction table.

Short-Range Straightness Measurement

Accuracy

Metric: ± 0.4 micrometre/metre ± 2 counts in last digit.

Inch: ± 5 microinches/foot ± 1 count in last digit.

Resolution: same as above.

Lateral range: ± 2.5 mm (± 0.1 inch)

Axial range: 3 m (10 feet)

Long-Range Straightness Measurement

Accuracy: same as Short-Range version.

Resolution: one-tenth that of the Short-Range version.

Axial Range: 30 m (100 ft)

Automatic Compensation (worst case):

- For air temperature within range 20-30°C (68-85°) 1.3 ppm ± 2 counts (English 1.3 ppm ± 1 count.)
- For air temperature within range 13-40°C (55-105°F) 1.5 ppm ± 2 counts (English: 1.5 ppm ± 1 count.)

Ordering Information

5500C Laser Head	\$7500
5505A Laser Display	\$6200
5510A Automatic Compensator	\$5800
10550B Retroreflector	\$1265
10558A Beam Bender	\$1275
10559A Reflector Mount	\$710
10563A Material Temperature Sensor	\$485
10565B Remote Interferometer	\$3810
10579A Straightness Adaptor	\$1710
10690A Short-Range Straightness Interferometer	\$3400
10691A Long-Range Straightness Interferometer	\$3400

Price

Systems description

The 5501A Laser Transducer is a smaller interferometer intended as a built-in position sensor for servo control of linear motion of systems such as X-Y stages, machine tools and measuring machines. Using a single laser source, up to 4 axes of motion may be monitored simultaneously. This feature, plus numerous other design innovations, significantly lowers the cost of laser interferometer feedback. A range of output devices offers the choice of feedback control or digital display. Although the Laser Transducer is designed for original equipment manufacturers (OEM), simple installation techniques make it attractive for retrofit by end-users as well.

Specifications

Resolution: 0.16 μm (6 microinches) or 0.08 μm (3 microinches) using Plane Mirror Interferometer. Resolution Extension can increase measurement resolution up to a factor of 10.

Accuracy: ± 0.5 parts per million.

Range: up to 60 metres (200 feet) depending upon conditions (sum of axes for multi-axis configurations).

Number of axes: up to 4 depending on system configuration and environmental conditions. Maximum allowable measurement velocity: 18.3 meters/min (720 inches/min.)

Accessories

A wide variety of Interferometers, Retroreflectors, Beam Splitters, and Beam Benders allow application of the 5501A Laser Transducer to the most complex measurement problems.

Linear interferometer: most economical and widely used for linear displacement measurements.

Plane mirror interferometer: used for precision measurement and control of X-Y stage motion.

Single beam interferometer: extremely small linear measurement interferometer for applications where size and weight are critical.

Beam splitters and benders: optional components to divide and direct the laser beam to the individual measurement axes.

Electronic Outputs

A range of output formats are available for the 5501A Laser Transducer which provide compatibility with a wide variety of measurement applications.

Computer interface electronics: interface the 5501A Laser Transducer to virtually any digital processor or controller. This universal binary interface is ideal for position control systems with the most demanding response requirements.

Calculator interface electronics: based on Hewlett-Packard Desktop Computer and the Hewlett-Packard-Interface Bus provide completely integrated measurement packages. Designed for acquiring, reducing and displaying measurement data, this interface allows simple application of the 5501A Laser Transducer to a wide variety of measurement oriented machines.

English/metric pulse output electronics: provides a universal interface to almost all numerical controls for machine tools. Designed primarily to facilitate installation of the 5501A Laser Transducer on machine tools by Original Equipment Manufacturers, this interface provides inch or metric value pulses over a wide range of resolutions.

Ordering Information

5501A Laser Transducer	\$6500
10780A Receiver	\$520
10700A 33% Beam Splitter	\$370
10702A Linear Interferometer	\$1460
10703A Retroreflector	\$620
10707A Beam Bender	\$270

Price



PHYSICAL & OPTICAL MEASUREMENTS

Quartz Pressure Gauge

Models 2813B, 2816A

- 0.01 psi resolution (69 Pa)
- 0.025% Full Scale Accuracy
- Direct Surface Readout
- Simple Operation
- Long Term Stability
- 200-11000 PSIA Range

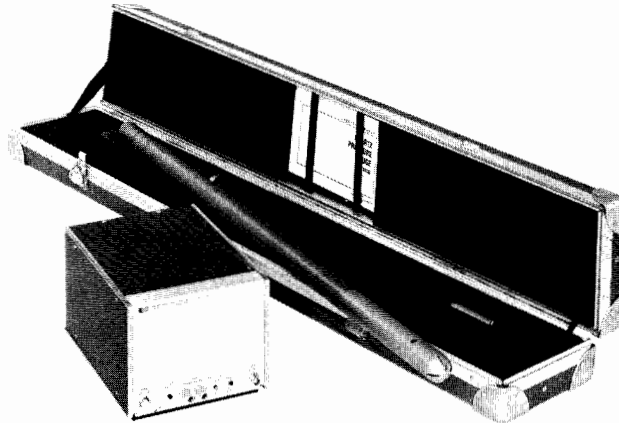

2816A Pressure Signal Processor,
2813B Quartz Pressure Probe

0.01 psi Resolution at 11,000 psi (69 Pa @ 69 MPa)

The HP quartz pressure gauge measures wellbore pressure with a resolution of 0.01 psi over a dynamic range in excess of 11,000 psi. This capability makes it possible to measure pressure changes that cannot be detected with conventional gauges using bourdon tube transducers.

This ability to detect and record small pressure changes allows sophisticated test techniques to be used economically. For example, since the super-sensitive HP quartz pressure gauge can detect small pressure transients at observation wells, pulse tests can be conducted with extremely short pulse cycle times at the stimulus well. Because the shut-in time is reduced, the permeability and formation thickness between wells can be determined at a substantially lower cost.

With the gauge, pressure transients can be observed and recorded on the surface while the test is in progress. When the surface readout indicates the test is completed, the gauge can be retrieved immediately. Pressure data can be read directly without intermediate scaling or other calculations, when used with the 2820A Pressure Recording System.

The quartz pressure gauge was specifically designed for pressure measurement in oil and gas wells and it is used by many oil companies and well service companies. However, its high resolution pressure measuring capability and rugged construction also make it ideally suited for oceanographic research and subterranean hydrodynamic studies.

Description

The gauge consists of a 2813B Quartz Pressure Probe and a 2816A Pressure Signal Processor. A frequency signal proportional to pressure is transmitted from the bottom-hole pressure probe to the signal processor on the surface. It travels through a single-conductor, armored electric line. The processor conditions the pressure-related signal to drive a separate electronic frequency counter for direct readout. An HP Desktop Computer may be used to calculate bottom hole pressure from the probe frequency and temperature. If a preset counter is used wellbore pressure will be displayed in psi. No scaling or intermediate calculations are necessary.

For field use, the 2820A Pressure Recording System is available. It provides a convenient method of obtaining direct visual display and a permanent record of pressure data. Test pressure data is recorded on a strip chart recorder, digital printer, and magnetic tape. All instruments are shock mounted in a rugged field case to withstand rough handling.

System Specifications

Sensitivity: (105 Hz/psi) 105 Hz/6.9 kPa nominal output of signal processor.

Probe operating pressure range: 0–82.7 MPa (0–12,000 psia.)

Probe operating temperature range: 0 to 150°C (32° to 302°F.)

Signal processor operating temperature range: 0° to 55°C (32° to 131°F.)

Calibrated pressure range: 1.4–75.8 MPa (200–11,000 psia.)

Resolution: 69 Pa (0.01 psi) when sampling for a 1-second period.

Repeatability: ± 2.76 kPa (± 0.4 psi) over entire range.

Accuracy (at thermal equilibrium) if operating temperature is known

within 1°C (1.8°F): ± 3.45 kPa or ± 0.025% of reading (± 0.5 psi or ± 0.025% of reading.)

within 10°C (18°F): ± 6.89 kPa or ± 0.1% of reading (± 1 psi or ± 0.1% of reading.)

within 20°C (36°F): ± 34.5 kPa or ± 0.25% of reading (± 5 psi or ± 0.25% of reading.)

Dimensions and Weights

2813B Probe: 36.5 mm (1.4") OD by 1000 mm (39.4") long.

Weight: 5.0 kg (11 lb.)

2816A Signal Processor: 154 mm H x 197 mm W x 279 mm D (6.1" x 7.8" x 11".)

2813B Quartz Pressure Probe

2816A Pressure Signal Processor

Price
\$19,850

\$1,600

PHYSICAL & OPTICAL MEASUREMENTS

Pressure Recording System

Model 2820A



- Surface readout and recording for the 2813B Quartz Pressure Probe
- Failsafe operation protects test data
- Autorestart after power interrupt minimizes data loss

- No set-up calculations or interpolation
- Connects directly to wireline from pressure probe
- Flexible system can be expanded



2820A
System

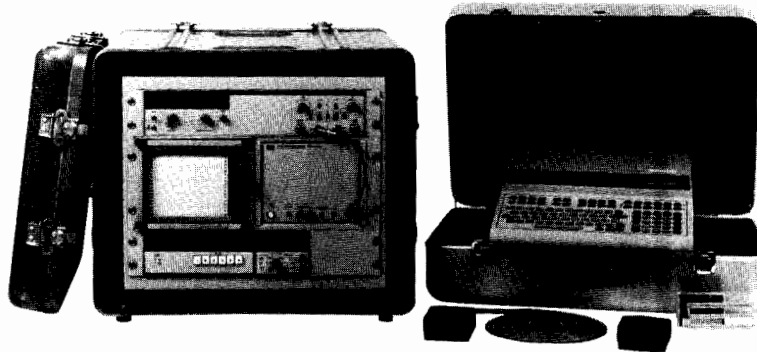

Description

The HP 2820A Pressure Recording System provides surface readout and recording for the 2813B Quartz Pressure Probe. Pressure test data (time, bottom hole pressure, and temperature) is automatically displayed, printed, and recorded on magnetic tape and a strip chart while the test is in progress. The system is simple to set up and operate. Many built-in checks are provided to protect against accidental operator entries and other conditions that would cause an error and halt operation. The user can add other HP-IB compatible instruments and peripherals to the 2820A system to display and plot the pressure test data for extensive analysis after the test.

Easy to Use

The 2820A Pressure Recording System is easy to set up and operate, even by an operator that has no experience in programming. Programs are run by simply pressing function keys on the computer and making entries that are requested by its program. The operator is guided by the computer display and printed messages.

While setting up for a test, the operator can print out a detailed list of instructions to help check system wiring, switch settings and function keys to run the programs.

Auto Restart After Power Interrupt

In case of a power interruption, the quantity of lost test data is minimized with the automatic restart capability of the 2820A. The system automatically restarts and resumes logging pressure data without an operator when power returns. This feature is enabled by pressing the START TEST function key. A backup battery inside the real time clock insures continuous operation.

Failsafe Operation Minimizes Errors

The 2820A Pressure Recording System has several "failsafe" features that bypass many operating conditions that would halt operation due to non-data errors. For example, the program checks all operator entries for validity and rejects any entry that would cause an error. The program even protects against pressing function keys out of sequence by ignoring the invalid function key.

The computer is programmed to automatically skip logging program instructions to print data (or record it on magnetic tape) if the printer runs out of paper (or the tape files are full). Recovery is also automatic when the error condition is cleared.

Flexible System Can Be Expanded

The 2820A Pressure Recording System is a standard system that can be expanded easily to meet individual needs. For example, the time and effort required to analyze pressure test data is reduced dramatically when field tape data is automatically plotted or displayed on HP-IB compatible plotting and display instruments added by the user.

2820A Operating Characteristics

Data display: real or elapsed time, pressure, temperature, logging time remaining on magnetic tape.

Printed data: real or elapsed time, pressure, temperature.

Tape recorded data: real time, pressure, temperature.

Real time: current month, day, hours, minutes and seconds.

Elapsed time: days, hours, minutes, seconds since START TEST key was pressed.

Display and Chart Recorder Update Time Interval

Pressure Resolution	Nominal Display and Chart Recorder Update Time	
	Min	Max
0.01 Psi	1 Sec	2 Sec
0.001 Psi	1 Sec	10 Sec

Printing and Magnetic Tape Recording Time Interval Selected By User

Pressure Resolution	Nominal Printing and Magnetic Recording Time (Print Interval)		
	Min	Max	Increment
0.01 Psi	2 Sec	99999 Sec	1 Sec
0.001 Psi	10 Sec	99990 Sec	10 Sec

Data recording capacity: each field tape stores 24 hours (nominal) of test data with 10 second Print Interval.

Temperature input: keyboard entry by operator or calculated from a continuous frequency input to counter.

2820A System Operating Modes

(Factory settings are in italics) Pressure data in *psi* or *kg/cm²*. Temperature data in degrees *Fahrenheit* or *Celsius*. Temperature input from *9825 keyboard* or frequency counter. Test data printed on *9825 printer* or *9866B printer* after test. Maximum resolution of *0.01 psi* (*0.001 kg/cm²*) or *0.001 psi* (*0.0001 kg/cm²*). Strip chart recorder *on* or *off*.

2820A System Operating Variables

(Changed during test by keyboard entry)

Print interval: pressure data is printed every 2 to 99999 s (or 10 to 99990 s).

P:T ratio: 1 to 99 lines of time and pressure data are printed before each line of temperature data.

Well temperature: 32 to 302°F (0 to 150°C).

Chart scale: full scale on the strip chart recorder can be set between 1 psi and 10,000 psi.

Instruments: program flags are to enable/disable the record instructions for DAC/chart recorder, printer, and magnetic tape.

2820A Pressure Recording System \$23,100

Includes instruments in shock isolated fiberglass transit case and 9825 computer in padded aluminum case.

PHYSICAL & OPTICAL MEASUREMENTS

Quartz Thermometer

Model 2804A



- $\pm 0.04^\circ\text{C}$ Absolute Accuracy
- 0.0001°C or 0.001°F Resolution
- -80° to $+250^\circ\text{C}$ Range
- Display of Absolute or Differential Temperature
- Flexible HP-IB System Interface
- Variable Resolution Analog Output
- Easy Ice Point or Triple Point Adjustment



The 2804A Quartz Thermometer allows you to easily measure temperature with exceptionally high accuracy and resolution. Absolute accuracy is ± 40 millidegrees Celsius over the range of -50°C to 150°C , NBS traceable to IPTS-68. The useable resolution of 0.0001°C allows you to measure temperature changes that could not be detected by other digital thermometers.

The 2804A can be used with one or two temperature sensing probes. The temperature of either probe, or their difference, can be measured and displayed under pushbutton control. Display resolution is selectable from 0.01 to 0.0001°C (0.1 to 0.001°F) by pushbuttons. An internal switch allows you to easily select measurement in the Celsius or Fahrenheit temperature scale.

Temperature is measured and displayed automatically with the microprocessor and electronics provided in the 2804A package. There is no need to balance a bridge, perform calculations using resistance- or voltage-temperature tables or curves, or to use calibration correction tables. The only adjustment necessary to remove effects of thermal history on the sensor is a simple ice point or triple point calibration adjustment using the front panel thumbwheel switches.

How It Works

The 2804A temperature sensor is a quartz crystal whose precise angle of cut gives a stable and repeatable relationship between resonant frequency and temperature. Each quartz sensor is individually calibrated at the factory over the full temperature range. The calibration data for each sensor is processed and stored in a calibration module which is supplied with the probe.

In operation, a microprocessor in the thermometer performs the complex control and calculation operations to accurately measure temperature from the quartz sensor frequency and probe calibration information in the calibration module. The microprocessor also performs self-checks to detect fault conditions. If a problem occurs that would give an improper measurement, an error message is displayed to indicate the source of the problem.

System Oriented Design

The HP-IB option offers you a simple, yet flexible, way to connect the Quartz Thermometer to either an HP computing controller or printer. Temperature data can easily be sent to a calculator or computer for processing and recording. All front panel controls can be operated automatically by commands sent on the bus.

The optional analog output converts any three consecutive digits to a voltage between 0 and +10 volts to drive a chart recorder. Front panel controls allow easy adjustment of pen zero and full scale as well as normal or offset (center-zero) operation. Any three digits can be

selected for conversion allowing you to change the full scale value on the recorder.

2804A Specifications

Performance

Range: -80 to 250°C .

Absolute accuracy: 2804A with 18110A, 18111A, 18112A or 18117A Quartz Probe —

$\pm 0.040^\circ\text{C}$ from -50 to 150°C

$\pm 0.075^\circ\text{C}$ from -80 to 250°C

NBS traceable to IPTS-68

Resolution: Three levels can be selected —

Level of selection	Resolution		Nominal time between readings in seconds	
	$^\circ\text{C}$	$^\circ\text{F}$	T1 or T2	T1 - T2
Low	0.01	0.1	0.1	0.2
Medium	0.001	0.01	1	2
High	0.0001	0.001	10	20

General

Display: 7 digit LED with polarity, decimal, and degree C or F annunciator.

Probes: a variety of probes are available for use with the 2804A. Refer to the data sheet for specifications and sheath configurations.

Power Required

100, 120, 220, or 240 VAC, $+5\%$ – 10% , 48 to 66 Hz, <30 VA.

Options

006: Analog Output \$525

010: HP-IB Interface \$450

Accessories and Probes

18107A External Oscillator \$225

18108A Line Amplifier \$225

18109A Diagnostic Kit \$575

18110A Laboratory Probe and cal module, 25 mm (1") \$1300

18111A Laboratory Probe and cal module, 230 mm (9.1") \$1300

18112A Laboratory Probe and cal module, 460 mm (18.1") \$1300

18115A Heavy Duty Probe and cal module, 30 mm (1.2") \$1400

18116A Heavy Duty Probe and cal module, 100 mm (3.9") \$1400

18117A Heavy Duty Probe and cal module, 180 mm (7.1") \$1400

2804A Quartz Thermometer

\$3200



Faxitron® Cabinet Systems

Radiography, the art and science of making pictures with X-rays, has an important place in modern technology. It is one of the major nondestructive test methods available to industry, provides an indispensable tool in scientific investigations and is a valuable aid to law enforcement agencies. Hewlett-Packard makes a major contribution to these activities with X-ray equipment that offers a "better way" through advanced technology and design. This equipment makes radiographs easier and safer to take.

Industrial Inspection

Industrial quality control and inspection procedures, especially in the field of electronics, benefit from nondestructive testing by radiography. The advantages of a testing method which does not harm the test objects are obvious. Radiography, therefore, offers benefits in design engineering, incoming inspection, production quality control, product reliability and failure analysis. X-rays are used to detect misregistration or plate-thru problems in multi-layer P.C. boards; porosity, poor substrate bonding and wiring or lead location in transistors and integrated circuits; voids and other encapsulation problems in potted components; and solder balls or other defects in sealed relays.

Die casting is another industry that benefits from the nondestructive aspects and abil-

ity to "see inside" provided by radiography. Porosity, gas voids, tramp metal inclusion and other common defects can be easily detected and the cause determined. Expensive machining time can be avoided for castings found to be defective through X-ray inspection. The integrity of welds, alignment of connectors, inspection for proper assembly and mechanical defects are further examples of tests which radiography performs for industry. The benefits of X-ray testing are reduced production costs, better quality assurance and product safety. The results are increased profits.

Law Enforcement Applications

Radiography aids many law enforcement groups. Crime labs use X-rays to visualize certain types of latent fingerprints, for powder and lead splatter patterns in ballistics and for questioned-document examination. Medical examiners use X-rays for cause-of-death investigations and identification of remains. X-rays aid in examining parcels or mail to identify dangerous devices and to verify bomb circuitry.

These are among the many applications served by HP Faxitron® Cabinet X-ray Systems. They offer a unique combination of high quality radiographic capability, simplicity of operation and convenience of use which is expanding the capabilities of scientific and industrial concerns throughout the world.

Scientific Applications

Oceanography, geology, marine biology, paleontology, pathology, botany, forestry and agricultural research are a few examples of scientific disciplines that use X-rays. Applications range from the study of the interior anatomy of fossils to determining the viability of seeds.

43700 Series Flash X-Ray Systems

High-speed (flash) radiography is used to record and study dynamic events where interposed material, smoke, flame, debris, or pressure variations exclude the use of high-speed cameras. Typical events include ballistics, shaped charges, explosives, behind-armor studies, shock waves in solids, aerospace phenomena, and crash-injury studies.

The basic performance requirement of a flash X-ray system used for the study of transient mechanisms is to provide high resolution radiographs with exposure times short enough to eliminate motion blur. HP Series 43700 flash X-ray systems produce X-ray pulses of sub-microsecond (3-70 nanosecond) duration and are designed specifically for "stop motion" radiographic applications. All Model 43700 Series systems utilize the same basic components, the same electrical theory, and are modular in concept. Standard systems include 150 kV, 300 kV, 450 kV, and 1 MV Models.

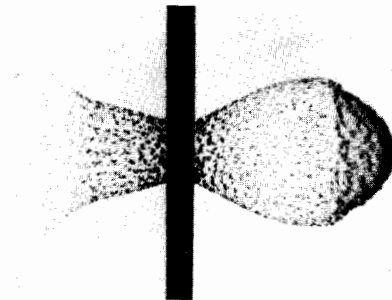

An HP basic single "channel" flash X-ray system, composed of a pulse generator, high-voltage power supply, cold-cathode field emission X-ray tube, and associated controls, provides a single radiograph per event. Additional pulser/X-ray tube sets (add-on channels) may be combined with the initial single-channel system to provide multiple-channel "systems." Multiple channel systems may be of identical output voltage or may use varied output voltage pulser/tube combinations.

For specific information and consultation regarding HP X-ray systems, contact Hewlett-Packard, 1700 S. Baker Street, McMinnville, Oregon 97128, telephone: (503) 472-5101.



MEASUREMENT ACCESSORIES

AC/DC Meter Calibrator

Model 6920B

- Calibrate/test DC ammeters up to 5 amps
- Calibrate/test average-reading AC ammeters up to 5 amps

- Calibrate/test DC voltmeters up to 1000 volts
- Calibrate/test average-reading AC voltmeters up to 1000 volts

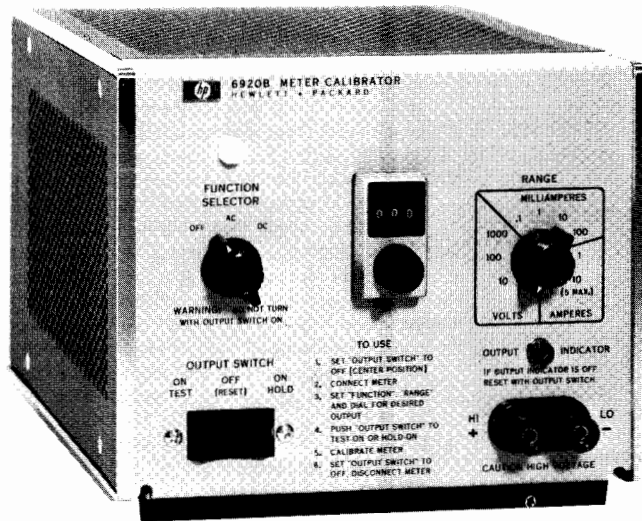

Description

Model 6920B is a versatile ac/dc meter calibrator, capable of both constant-voltage and constant-current output. Its absolute accuracy makes it suitable for laboratory or production testing of panel meters, multimeters, and other meters having accuracy on the order of 1.0% or higher. This calibrator has been designed for convenience, and combines in one instrument all the outputs needed to test the most commonly used meters.

Output Switch

The output switch has two ON positions. The ON TEST position has a momentary contact and output is obtained only while the switch is held ON. This is convenient when several full scale readings are being checked successively and the meter and calibrator are being switched through their ranges. The ON HOLD position is used when continuous output is desired.

AC Output Waveshape

When the function switch is set on AC, the output wave-shape is sinusoidal (to a first approximation) and has the same frequency as the input line power applied to the instrument (except when an external ac reference is used). The feedback loop, which controls and regulates this ac, is actually monitoring the average value of the ac output although the front panel controls are calibrated in terms of rms. Thus, this calibrator is suitable for use with average-reading ac voltmeters scaled in rms. In addition, the calibrator can be used with true-rms meters, provided allowance is made for the total output distortion. This distortion is approximately equal to the line input waveshape distortion (or distortion of the external ac reference) plus 3%.

Specifications

Output Voltage Ranges

0.01-1 V: current capability 0-5 A.

0.1-10 V: current capability 0-1 A.

1-100 V: current capability 0-100 mA.

10-1000 V: current capability 0-10 mA.

Above output voltage ranges and maximum current capabilities for each range apply for either dc or ac operation.

Output Current Ranges (5 A maximum output)

1-100 μ A: voltage capability 0-500 V (uncalibrated in AC).

0.01-1 mA: voltage capability 0-500 V.

0.1-10 mA: voltage capability 0-500 V.

1-100 mA: voltage capability 0-50 V.

0.01-1A: voltage capability 0-5 V.

0.1-10A: (5 A max. output) voltage capability 0-0.5 V.

Above output current ranges and maximum voltage capabilities for each range apply for either dc, 50 Hz or 60 Hz operations.

Output accuracy: DC—0.2% of set value plus 1 digit. AC—0.4% of set value plus 1 digit (when used with average-reading meters). Above accuracy applicable over a temperature range from 15°C to 35°C, over full input voltage range, and after 1-hour warmup.

Controls

Function switch: 3-positions: OFF, AC, and DC. In the OFF position the ac power input is disconnected from the unit. In the AC position the meter calibrator produces an ac output, and in the DC position the calibrator produces a dc output.

Range switch: 10 positions, one for each voltage and current range.

Calibrated output control: digital potentiometer readout control (3 significant digits) determines exact value of output.

Output switch: switch described at left.

Output terminals: two front panel terminals are provided; these are the output terminals for both ac and dc operation. In voltage ranges, the negative terminal is grounded.

Ripple: in dc operation the output ripple is typically less than 1.0% rms/5% p-p of the output range switch setting.

Input: 115 V ac \pm 10%, single-phase, 58-62 Hz, 0.7 A, 65 W max. (See Options 005 and 028 for 50 Hz and 230 V ac operation).

Operating temperature range: 0°C-50°C; convection cooled.

Size: 172 H x 198 W x 279 mm D (6 $\frac{3}{4}$ " x 7 $\frac{13}{16}$ " x 11").

Weight: net, 6.8 kg (15 lb). Shipping 7.71 kg (17 lb).

Options

005: 50 Hz output regulation realignment

028: 230 V ac \pm 10%, single phase input

Price

N/C

N/C

Accessories

5060-8762 Rack kit for mounting one or two 6920B's in a 19" rack

\$72.50

5060-8760 Filler panel to block unused half of rack adapter

\$26

6920B Meter calibrator

\$1600

MEASUREMENT ACCESSORIES

Instrument Accessories

Models 11473A-11476A, 15104A, 15115A & 15116A

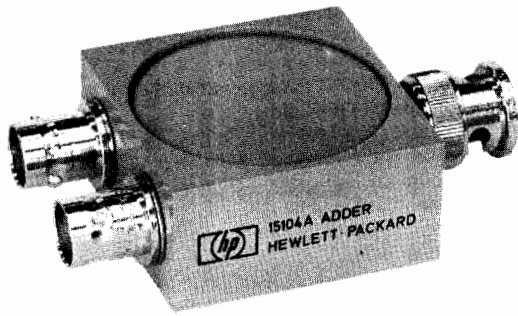

15104A Pulse Adder/ Splitter

50 ohm delta network decouples two loads for stimulation from common source, or combines two pulse forms.

Step response: 150 ps

Reflection: $\leq 10\%$ with 160 ps step (bandwidth dc to 2 GHz).

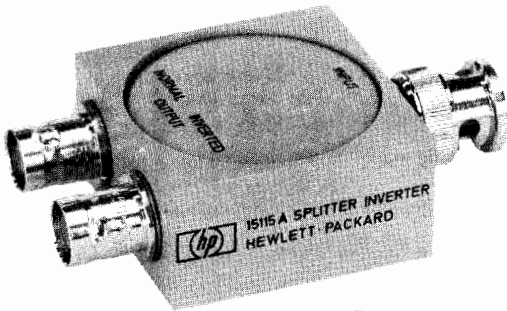

15115A Pulse Splitter/ Inverter

50 ohm delta network splits a single input pulse in two output pulses; inverted (via transformer) and non-inverted (direct).

	Inverted	Non-inverted
Step response:	400 ps	200 ps
Reflection (160 ps step)	$\leq 10\%$	$\leq 10\%$
Droop (300 ns pulse width)	$\leq 5\%$	$\leq 3\%$

Delay between inverted and non-inverted output: 1 ns

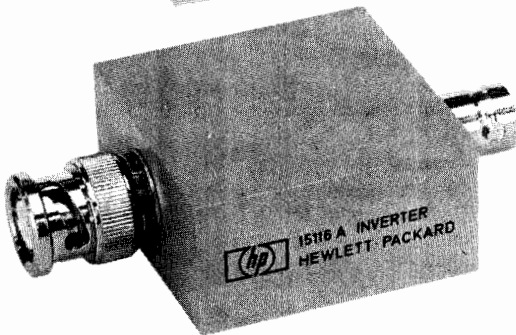

15116A Pulse Inverter

Transformer coupling, common ground, converts incoming pulse to opposite polarity.

Step response: 400 ps

Reflection (200 ps step): $\leq 10\%$

Droop (300 ns pulse width): $\leq 5\%$

Ordering Instructions

15104A Pulse Adder/ Splitter

15116A Pulse Inverter

15115A Pulse Splitter/ Inverter

Price

\$110

\$220

\$220

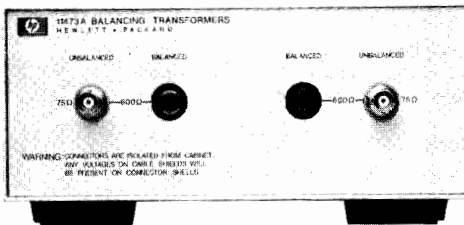

11473A-11476A Description

Balancing transformers provide a balanced output from a single-ended input, or a single-ended output from a balanced input. Impedances available are 75 ohms unbalanced to 124 Ω , 135 Ω , 150 Ω , and 600 Ω balanced. Frequency response is ± 0.5 dB.

(Each module contains two transformers with the following specifications)

Model No.		11473A	11473B	11474A	11475A	11476A
Impedance*	Unbal	75 Ω	75 Ω	75 Ω	75 Ω	75 Ω
	Bal	600 Ω	600 Ω	135 Ω	150 Ω	124 Ω
Mating connectors	Unbal	BNC	BNC	BNC	BNC	BNC
	Bal	WECO 310	Siemens 9 REL; STP-6AC	WECO 241	Siemens 9 REL; STP-6AC	WECO 408A
Frequency range:		20 Hz—50 kHz	20 Hz—50 kHz	2 kHz—2 MHz	2 kHz—2 MHz	5 kHz—5 MHz
Frequency response:		± 0.5 dB	± 0.5 dB	± 0.5 dB	± 0.5 dB	± 0.5 dB
Insertion loss:		<0.75 dB at 1 kHz	<0.75 dB at 1 kHz	<0.25 dB at 50 kHz	<0.25 dB at 50 kHz	<0.25 dB at 50 kHz
Longitudinal balance:		>40 dB	>40 dB	>40 dB	>40 dB	>35 dB
Max input power:		+13 dBm	+13 dBm	+27 dBm	+27 dBm	+27 dBm
Price		\$450	\$400	\$450	\$425	\$450

*50 Ω unbalanced to balanced transformer available on special basis. Above specifications apply.

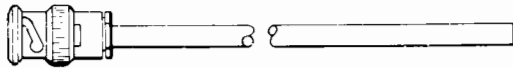

10501A: 112 cm (44 in)

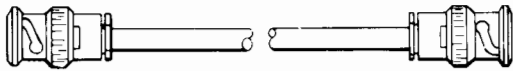
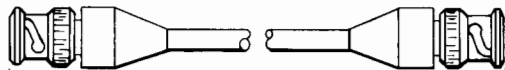
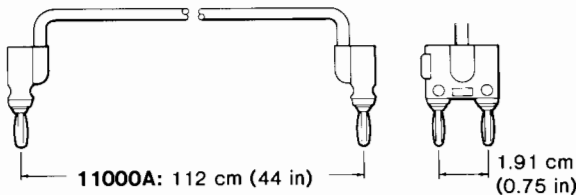
10502A L=23 cm (9 in)
10503A L=122 cm (48 in)
10519A L=183 cm (72 in)11170A: 30 cm (12 in)
11170B: 61 cm (24 in)
11170C: 122 cm (48 in)

11000A: 112 cm (44 in)

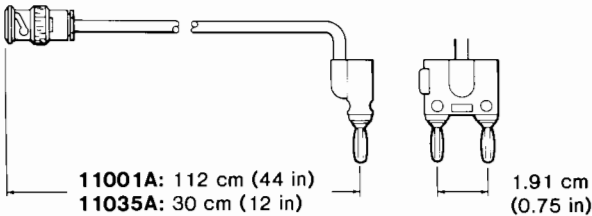
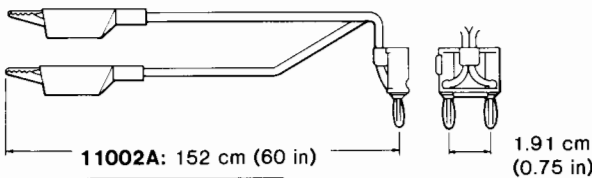
11001A: 112 cm (44 in)
11035A: 30 cm (12 in)

11002A: 152 cm (60 in)

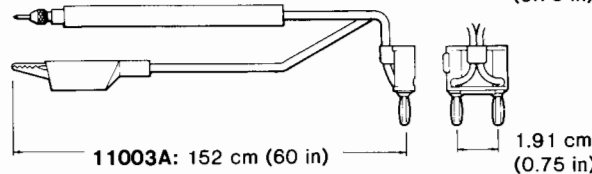

11003A: 152 cm (60 in)

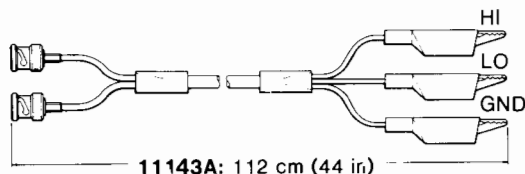

11143A: 112 cm (44 in)

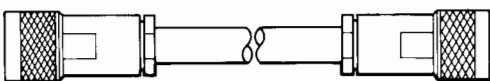
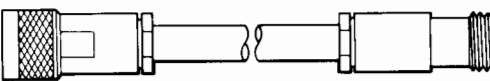
11500A: 183 cm (72 in)
11500B: 61 cm (24 in)

11501A: 183 cm (72 in)

Cable Assemblies

Price

10501A Cable Assembly

112 cm (44 in.) of 50-ohm coaxial cable terminated on one end only with UG-88C/U BNC (m) connector.

\$10

10502A Cable Assembly

23 cm (9 in.) of 50-ohm coaxial cable terminated on both ends with UG-88C/U BNC (m) connectors.

\$15

10503A Cable Assembly

122 cm (48 in.) of 50-ohm coaxial cable terminated on both ends with UG-88C/U BNC (m) connectors.

\$15

10519A Cable Assembly

183 cm (72 in.) of 50-ohm coaxial cable terminated on both ends with UG-88C/U BNC (m) connectors.

\$30

11170A Cable Assembly

30 cm (12 in.) of 50-ohm coaxial cable terminated on both ends with BNC (m) connectors.

\$20

11170B Cable Assembly

61 cm (24 in.) of 50-ohm coaxial cable terminated on both ends with BNC (m) connectors.

\$20

11170C Cable Assembly

122 cm (48 in.) of 50-ohm coaxial cable terminated on both ends with BNC (m) connectors.

\$23

11000A Cable Assembly

112 cm (44 in.) of 50-ohm coaxial cable terminated on both ends with a dual banana plug, for (3/4 in.) binding posts.

\$20

11001A Cable Assembly

112 cm (44 in.) of 50-ohm coaxial cable terminated on one end with a dual banana plug and on the other end with a UG-88C/U BNC (m) connector.

\$20

11035A Cable Assembly

30 cm (12 in.) of 50-ohm coaxial cable terminated on one end with a dual banana plug and on the other end with a UG-88C/U BNC (m) connector.

\$20

11002A Test Leads

152 cm (60 in.) test leads alligator clips to dual banana plug.

\$17

11003A Test Leads

152 cm (60 in.) test leads, probe and alligator clip to dual banana plug.

\$15

11143A Cable Assembly

112 cm (44 in.) test leads, dual BNC to alligator clips.

\$70

11500A Cable Assembly

183 cm (72 in.) of 50-ohm coaxial cable terminated on both ends with UG-21D/U Type N (m) connectors.

\$75

11500B Cable Assembly

Identical with 11500A except 61 cm (24 in.) long.

\$70

11501A Cable Assembly

183 cm (72 in.) of 50-ohm coaxial cable terminated with UG-21D/U Type N (m) and UG-23D Type N (f) connectors.

\$80

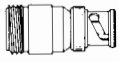

1250-0077
1250-1534
1250-1477

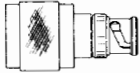

1250-0082
1250-1533
1250-1473



1250-1474
1250-1536

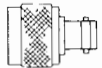

1250-0780
1250-1535
1250-1476

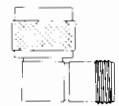

1250-0176

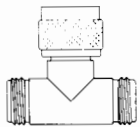

1250-0559

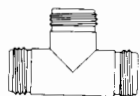

1250-0846



1250-0777
1250-1529
1250-1472

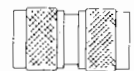

1250-0778
1250-1528
1250-1475



1250-1250



1250-1158



1250-1159



1250-0831



1250-1236



1250-0832



11524A



11525A



11533A



11534A



1250-0076
1250-1286

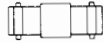

1250-0080
1250-1287



1250-0216
1250-1288

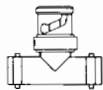

1250-0781



1250-1263

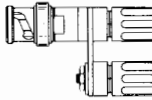

1250-1264

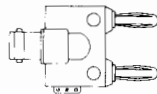

1251-2277

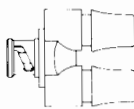

10110B

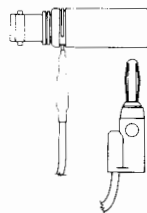

10111A

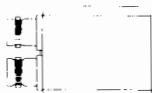

10113A

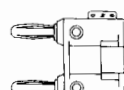

1251-2816

Adapters Type N, Standard 50Ω

Part Number

1250-0077 N (f) to BNC (m)	\$10.50
1250-0082 N (m) to BNC (m)	\$23.00
1250-0176 N (m) to N (f) right angle	\$37.00
1250-0559 N tee, (m) (f) (f)	\$23.50
1250-0777 N (f) to N (f)	\$10.50
1250-0778 N (m) to N (m)	\$11.50
1250-0780 N (m) to BNC (f)	\$9.00
1250-0846 N tee (f) (f) (f)	\$14.00
1250-1250 N (m) to SMA (f)	\$41.00

Adapters Type N, Precision¹ 50Ω

Part Number

1250-1472 N (f) to N (f)	\$22.50
1250-1473 N (m) to BNC (m)	\$24.50
1250-1474 N (f) to BNC (f)	\$15.00
1250-1475 N (m) to N (m)	\$33.00
1250-1476 N (m) to BNC (f)	\$21.00
1250-1477 N (f) to BNC (m)	\$19.00

Adapters Type N, Standard 75Ω²

Part Number

1250-1528 N (m) to N (m)	\$35.00
1250-1529 N (f) to N (f)	\$28.00
1250-1533 N (m) to BNC (m)	\$28.00
1250-1534 N (f) to BNC (m)	\$20.50
1250-1535 N (m) to BNC (f)	\$21.00
1250-1536 N (f) to BNC (f)	\$18.00

Adapters SMA

Part Number

1250-1158 SMA (f) to SMA (f)	\$12.00
1250-1159 SMA (m) to SMA (m)	\$18.00

Adapters SMB, SMC

Part Number

1250-0831 SMC (m) to BNC (m)	\$27.00
1250-0832 SMC (f) to BNC (f)	\$32.00
1250-1236 SMB (f) to BNC (f)	\$33.00

Adapters APC-7[®]

Part Number

11524A APC-7 to N (f)	\$125
11525A APC-7 to N (m)	\$125
11533A APC-7 to SMA (m)	\$175
11534A APC-7 to SMA (f)	\$175

Adapter Banana Plug

Part Number

1251-2816 Dual Banana plug	\$4.80
-----------------------------------	--------

Adapters BNC, Standard 50Ω

Part Number

1250-0076 Right angle BNC (UG-306/D)	\$8.50
1250-0080 BNC (f) to BNC (f) (UG-914/U)	\$5.00
1250-0216 BNC (m) to BNC (m)	\$8.00
1250-0781 BNC Tee (m) (f) (f)	\$10.50
1250-1263 BNC (m) to single banana plug	\$10.00
1250-1264 BNC (m) to dual banana plug	\$20.00
1251-2277 BNC (f) to dual banana plug	\$12.50
10110B BNC (m) to dual banana plug	\$40.00
10111A BNC (f) to shielded banana plug	\$25.00
10113A Dual BNC (f) to triple banana plug	\$25.00

Adapters BNC, Standard 75Ω³

Part Number

1250-1286 Right Angle BNC	\$12.50
1250-1287 BNC (f) to BNC (f)	\$6.75
1250-1288 BNC (m) to BNC (m)	\$11.00

¹ "Precision": typically ≥ 36 dB return Loss to 1.3 GHz.

² Type N outer conductor; center pin sized for 75Ω characteristic.

³ BNC outer conductor; center pin sized for 75Ω characteristic.

[®] A registered trademark of the Bunker Ramo Corporation

CABINETS: TRANSIT, OPERATING & COMBINING CASES

Cabinet Identification

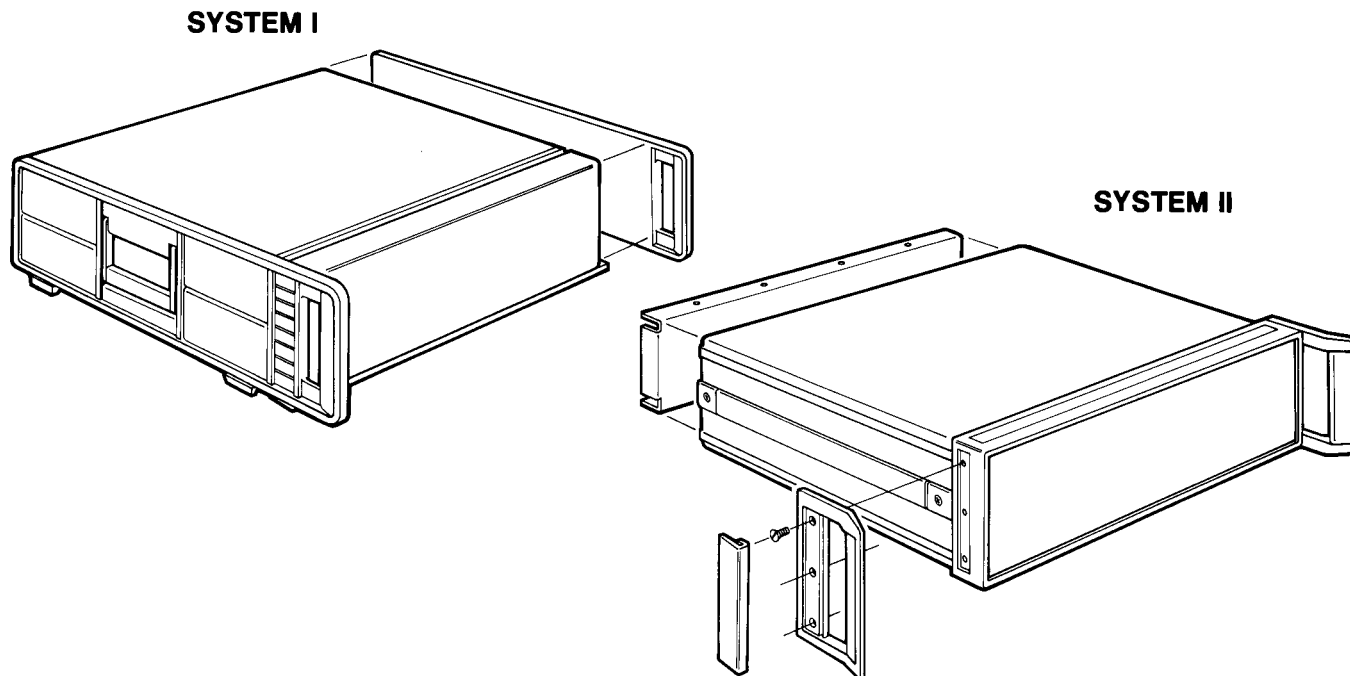

The two disassembly drawings above are for identification only. They illustrate differences between SYSTEM I and SYSTEM II cabinets (instruments come assembled from the factory).

SYSTEMS I and II

SYSTEM I was Hewlett Packard's first modular enclosure system. SYSTEM II, introduced in the early 1970's, superseded SYSTEM I and is now the standard package in which all instruments are being introduced. Compatibility of the two systems was carefully considered, but they are basically different in design and have similar but non-interchangeable accessories.

System Differences

The notable difference in the two systems is that SYSTEM I has cast aluminum side frames while SYSTEM II has cast aluminum front and rear frames. The SYSTEM I side frames are secured together by sheet metal panels, while the SYSTEM II front and rear frames are secured by cast aluminum struts then enclosed in sheet metal.

Another distinguishable feature is in the front handles on the full module cabinets. SYSTEM I front handles extend straight forward, have rounded corners and are an integral part of the side frames.

SYSTEM II front handles flair outwards slightly, have square corners and are separable from the cabinet.

Proper Ordering

These differences in design necessitate separate lines of accessories. When ordering, it is most important to identify your cabinet system.

For specific reasons (like disc memories, as an example) Hewlett Packard also manufactures enclosures different from either SYSTEM I or SYSTEM II. If your HP device enclosure is far different from those pictured here, please see the accessories listed with that device shown elsewhere in this catalog.

Sub-module Cabinets

Hewlett Packard also uses cabinets of smaller width than the full module size. SYSTEM I design called for sub-modules to be $\frac{1}{3}$ or $\frac{1}{2}$ of the full module dimension. SYSTEM II, designed for miniaturized circuits, uses sub-modules of $\frac{1}{4}$ or $\frac{1}{2}$ of full module size. You can identify your cabinet system using the same basic concepts as outlined in "System Differences" above. It is important to do so for the accessories in each system are different and not interchangeable.

Rack Mounting

SYSTEM I and SYSTEM II products can be mounted vertically in the same rack cabinet, or stacked on one another. However, the rack mounting hardware is not interchangeable, nor can SYSTEM I and SYSTEM II sub-modules be combined in the same horizontal rack space.

SYSTEM II module size and rack mounting hole spacing meet the specifications described in EIA Standard RS-310-C for Racks, Panels and Associated Equipment.

SYSTEM I

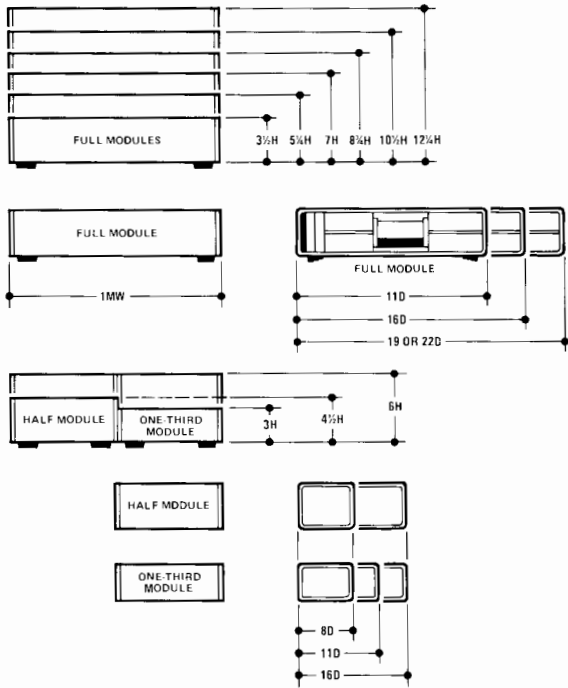

SYSTEM II

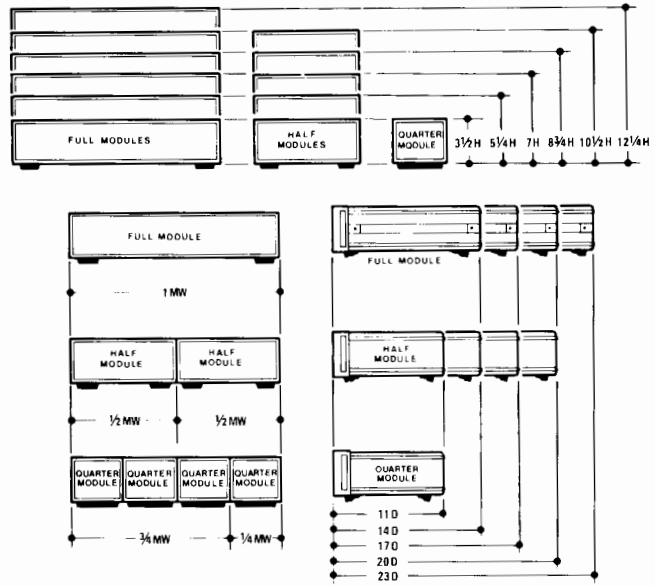

Summary of Nominal and Actual Sizes for SYSTEM I Modules				
Nominal Instrument Height ¹		Actual Height ¹		
mm	inches	mm	inches	
76	3	77.0	3.031	
89	3 1/2	85.7	3.375	
114	4 1/2	115.9	4.562	
133	5 1/4	127.8	5.031	
152	6	154.7	6.093	
178	7	172.3	6.781	
222	8 3/4	216.7	8.531	
267	10 1/2	261.1	10.281	
311	12 1/4	306.6	12.031	
Nominal Instrument Width ²		Actual Width ²		
		mm	inches	
1/3 MW ³		130.2	5.125	
1/2 MW		197.6	7.781	
1 MW ⁴		425.5	16.750	
Nominal Instrument Depth ⁵		Actual Depth		
mm	inches	mm	inches	
203	8	203.2	8.000	
279	11	279.4	11.000	
279	11	285.6	11.250 ⁶	
406	16	406.4	16.000	
406	16	415.9	16.375 ⁶	
483	19	492.1	19.375	
559	22	568.3	22.375	

Summary of Nominal and Actual Sizes and EIA Specifications for SYSTEM II Modules				
Nominal Instrument Height ¹		EIA "U" Equivalent ²	Actual Front Frame Height	
mm	inches		mm	inches
89	3 1/2	2U	88.1	3.469
133	5 1/4	3U	132.6	5.219
178	7	4U	177.0	6.969
222	8 3/4	5U	221.5	8.719
267	10 1/2	6U	265.9	10.469
311	12 1/4	7U	310.4	12.219
Nominal Instrument Width			Actual Front Frame Width	
			mm	inches
1/4 MW ³			105.7	4.160
1/2 MW			212.3	8.360
3/4 MW ⁴		318.9	12.550	
1 MW ⁵		425.5	16.750	
Nominal Instrument Depth ⁶			Actual Instrument Depth	
mm	inches		mm	inches
279	11		269	10.6
356	14		345	13.6
432	17		422	16.6
508	20		498	19.6
584	23	574	22.6	

¹This is the nominal height only and does not include feet. Add 0.5" for cabinet height with feet.
²Combining Cases or Rack Adapter Frames are required if a SYSTEM I cabinet, which is less than full module width (1 MW) is to be rack mounted. See SYSTEM I accessories.
³MW = Module Width of 425.5 mm (16.750 inch) as standard.
⁴Adding SYSTEM I rack flanges extends the 1 MW dimension to the width necessary for mounting in a standard 482.6 mm (19.000 inch) rack.
⁵Depth dimension includes basic instrument only, does not include protrusions such as controls, front handles, etc.
⁶Full Module cabinet size

¹This is the nominal front frame height only and does not include feet.
²U = Panel Height increment. Actual panel height is equal to 44.45 x U - 0.8 mm (1.750 x U - .031 inch). See EIA RS-310-C or IEC 297-1975.
³MW = Module Width to fit a standard 482.6 mm (19.0 inch) rack.
⁴HP Products are not available in SYSTEM II cabinets < 1/2 MW, but this is a useful dimension to indicate front panel widths to fill.
⁵Adding SYSTEM II rack flanges extends the 1 MW dimension to the width necessary for mounting in a standard 482.6 mm (19.0 inch) rack.
⁶Depth dimension includes basic instrument only; does not include protrusions such as controls, front handles, etc.

CABINETS: TRANSIT, OPERATING & COMBINING CASES

SYSTEM II—General Accessories¹

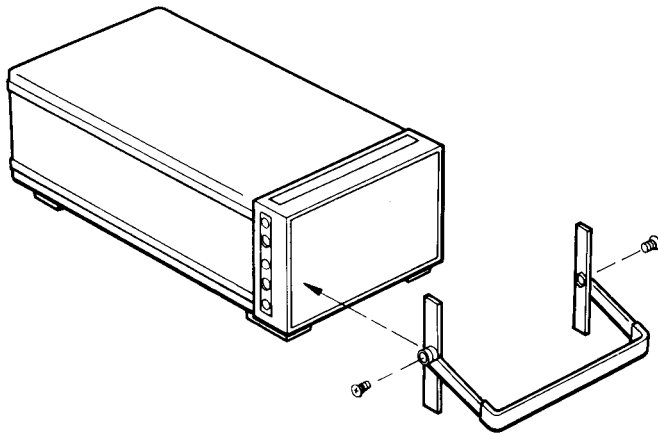

Bail Handle Kit

Bail Handle Kit				
Application	Description	Size	Part No.	Price
½ MW (Half Module) Only	Convenient carrying handle for lightweight cabinets this high:	3½ H	5061-2001	\$22.50
		5¼ H	5061-2002	33.00
		7 H	5061-2003	29.00

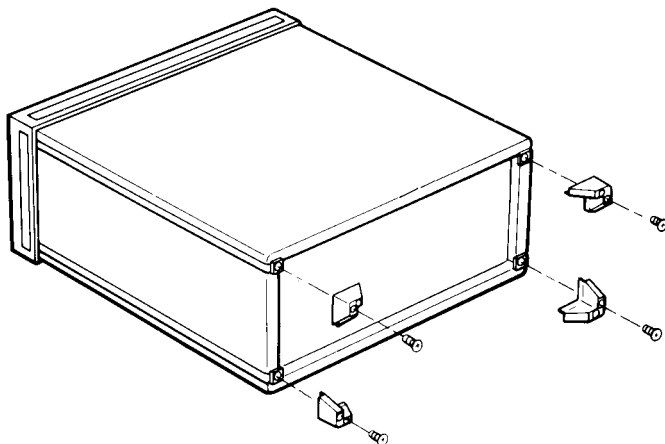

Rear Panel Stand-Off Kit

Rear Panel Stand-Off Kit			
Application	Description	Part No.	Price
For all cabinets—except does not normally fit cabinets which are ¼ MW by 3½ H.	Kit of four special feet which provide 25.4 mm (1 in.) stand-off protection to rear panel. Used when instrument is operated in vertical position, or when it is transported/stored on its rear panel.	5061-2009	\$8.75

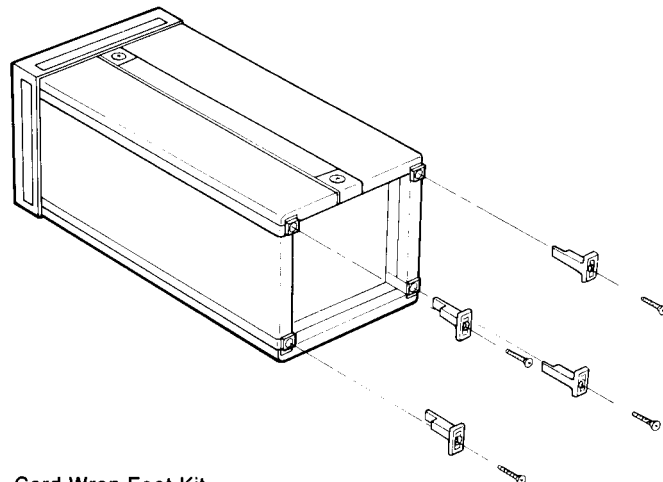

Cord Wrap Feet Kit

Cord Wrap Feet Kit			
Application	Description	Part No.	Price
Recommended for products only ¼ MW and ½ MW weighing less than 11 kg (24 lbs.)	Kit of four flanged posts on which power cords or signal cables may be wrapped for transport/storage. It provides flanged cord wrap posts as a convenient way to keep power cords and signal cables with an instrument (not designed for heavy duty support; use kit 5061-2009 for such applications.)	5061-0095	\$11.50

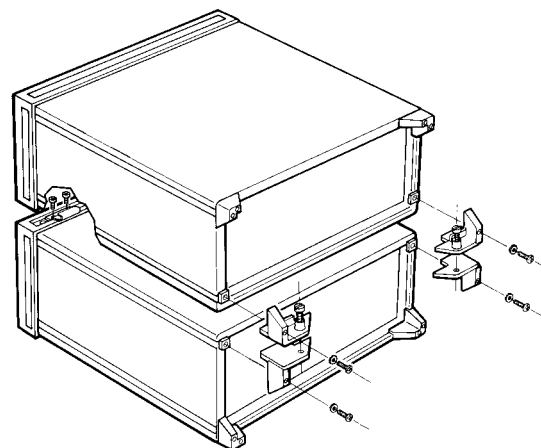

Rear Panel Lock Foot Kit

Full Module Cabinet Lock Foot Kit		
Description	Part No.	Price
Combines Full Modules vertically. Used in combination with Rear Panel Standoff (5061-2009) only. Kit consists of right and left foot pairs, front lock links and fasteners—order 5061-2009 separately.	5061-0099	\$40.00

¹All kits are supplied with appropriate mounting screws.

CABINETS: TRANSIT, OPERATING & COMBINING CASES

SYSTEM II—General Accessories¹

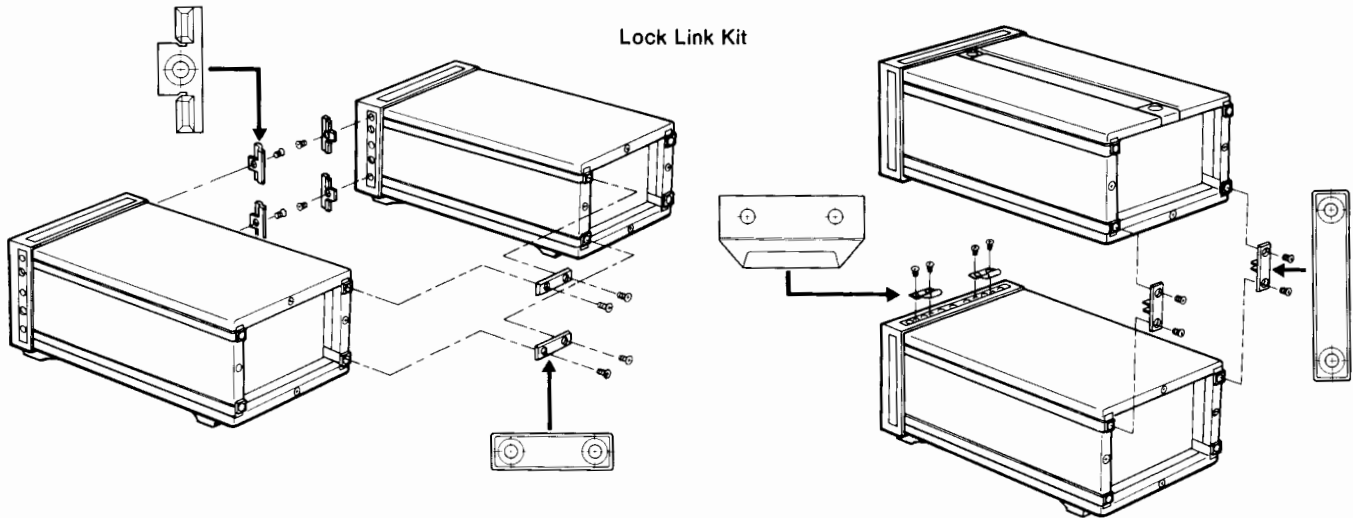

Lock Link Kit

Lock Link Kit			
Application	Description	Part No.	Price
For use with all subModule cabinets, provided they are of equal depth. ² It is easy to group instruments together horizontally or vertically by using simple lock links. The links can be installed by using threaded holes already provided in the framework, allowing quick assembly and separation of instruments.	Kit consists of lock hardware and screws for joining instrument cabinets in several different configurations. Enough horizontal links (12 front, 6 rear) for three side-by-side joints (up to 4 instruments), and enough vertical links (4 front, 4 rear) to form two over/under joints (up to 3 instruments). ²	5061-0094	\$40.00

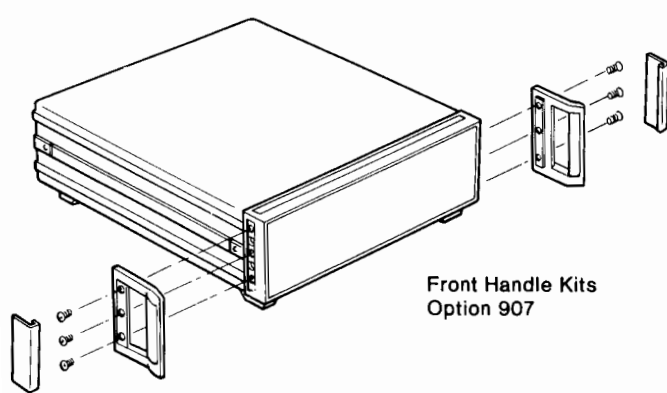

Front Handle Kits
Option 907

Front Handle Kit				
Application	Description	Size	Part No.	Price
For use with all cabinets—but principle use is on 1 MW (Full Module) cabinets, or on sub-Module cabinets locked together to form width of 1 MW. Will be shipped with instrument, if ordered as Option 907 at same time. Otherwise available separately per Part Numbers listed at right.	Kit includes two front handles to fit on each side of front panel frames, for cabinets this high:	3½ H	5061-0088	\$ 46.00
		5¼ H	5061-0089	62.50
		7 H	5061-0090	62.50
		8¾ H	5061-0091	65.00
		10½ H	5061-0092	77.50
		12¼ H	5061-0093	100.00

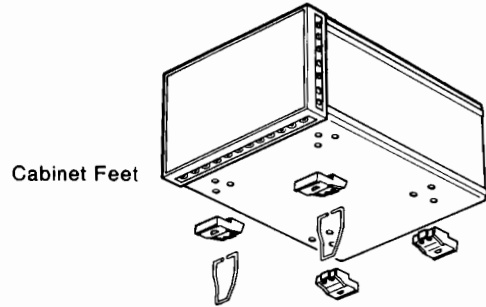

Cabinet Feet

Full and Half Module Cabinet Feet		
Application	Part No.	Price
Standard foot (1): fits bottom of 1 MW and ½ MW cabinets (requires 2 front, 2 rear).	5040-7201	\$1.75 ea.
Tilt stand (1): fits onto standard foot and is used in pairs (front or rear).	1460-1345	\$0.85 ea.
Non-skid foot (1): used (in pairs) in lieu of standard rear or front foot, to minimize bench-top creeping.	5040-7222	\$3.40 ea.

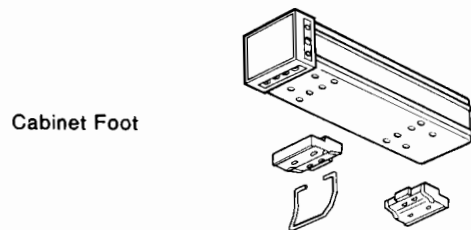

Cabinet Foot

Quarter Module Cabinet Foot		
Application	Part No.	Price
Standard foot (1): fits bottom of ¼ MW cabinet (requires 1 in front, 1 in rear).	5040-7205	\$5.00 ea.
Tilt stand (1): fits onto ¼ MW standard foot (only 1 used, for front or rear).	1460-1369	\$1.35 ea.

¹All kits are supplied with appropriate mounting screws.

²Locking cabinets together horizontally in a configuration wider than 1 MW (Full-Module) is not recommended.

CABINETS: TRANSIT, OPERATING & COMBINING CASES

SYSTEM II—Rack Mounting Accessories¹

For full Module Cabinets

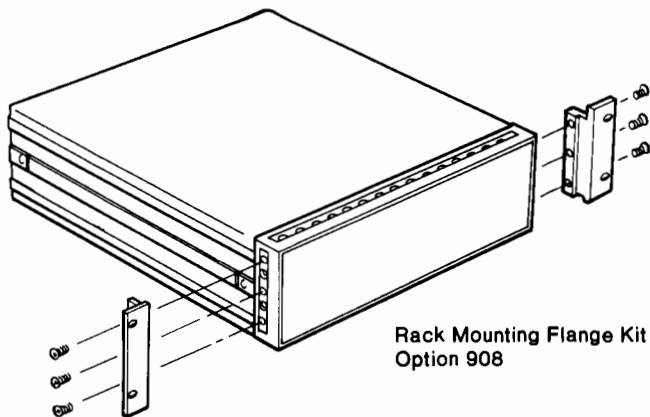

Rack Mounting Flange Kit
Option 908

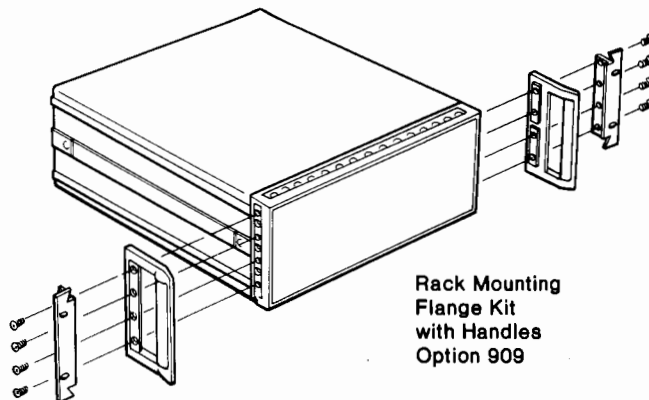

Rack Mounting
Flange Kit
with Handles
Option 909

Rack Mounting Flange Kit				
Application	Description	Size	Part No.	Price
Will be shipped with instrument, if ordered as Option 908 at same time. Otherwise available separately per Part Numbers listed at right.	Kit includes two rack flanges to fit on each side of front panel	3½ H	5061-0074	\$16.50
		3½ H	5061-0076*	22.50
		5¼ H	5061-0077	25.00
		7 H	5061-0078	26.00
		8¾ H	5061-0079	29.00
		10½ H	5061-0080	34.00
		12¼ H	5061-0081	39.00
Note: 5061-0074 has 1.75" hole spacing and has the standard flange. 5061-0076 has 3.00" hole spacing and has a special flange.				

Rack Mounting Flange Kits with Handles				
Application	Description	Size	Part No.	Price
Combination kit. Will be shipped with instrument, if ordered as Option 909 at same time. Otherwise available separately as Part Numbers listed at right.	Kit includes two rack flange/front handle combinations to fit on each side of front panel	3½ H	5061-0075	\$ 55.00
		3½ H	5061-0082*	72.50
		5¼ H	5061-0083	85.00
		7 H	5061-0084	85.00
		8¾ H	5061-0085	92.50
		10½ H	5061-0086	105.00
		12¼ H	5061-0087	130.00
Note: 5061-0075 has 1.75" hole spacing and has the standard flange. 5061-0082 has 3.00" hole spacing and has a special flange.				

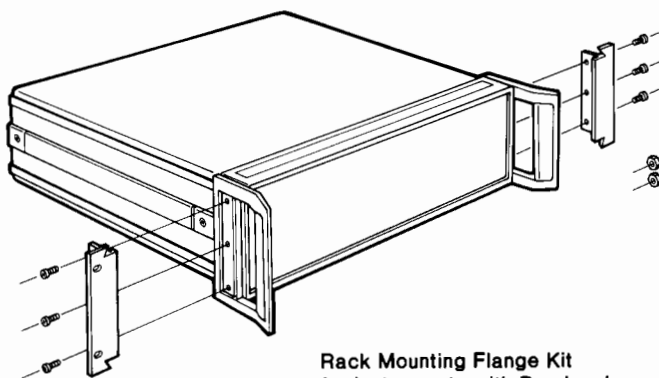

Rack Mounting Flange Kit
for Instruments with Previously
Mounted Handles
Option 913

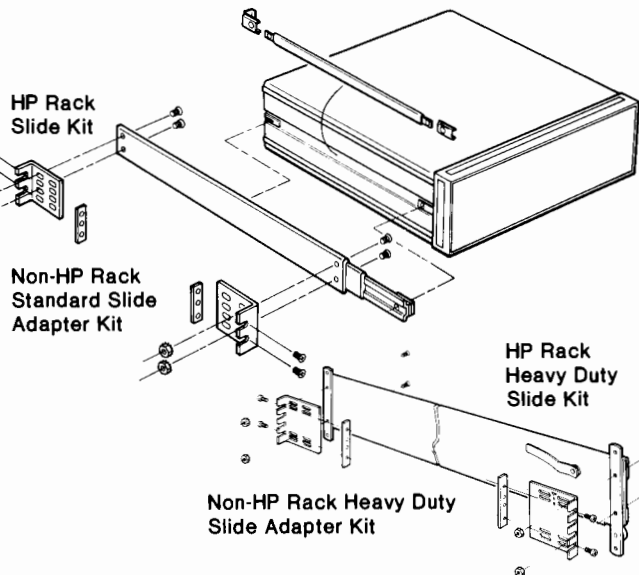

Rack Mounting Flange Kit for Instruments with Handles				
Application	Description	Size	Part No.	Price
Will be shipped with instrument, if ordered as Option 913 at same time. Otherwise available separately as Part Numbers listed at right.	Kit includes two rack flanges to fit on each side of front panel	3½ H	5061-2069	\$23.00
		3½ H	5061-2070*	36.00
		5¼ H	5061-2071	33.00
		7 H	5061-2072	35.00
		8¾ H	5061-2073	41.00
		10½ H	5061-2074	49.00
		12¼ H	5061-2075	50.00
Note: 5061-2069 has 1.75" hole spacing and has the standard flange. 5061-2070 has 3.00" spacing and has a special flange.				

Slide Kits and Adapter Brackets				
Application	Description	Size	Part No.	Price
Kit of 2 slides that fit side handle recess of instruments for mounting in HP Racks	Standard slides. Max loading: 38.6 Kg (85 Lbs.) for cabinets this deep:	14D & 17D	1494-0018**	\$ 90.00
		20D & 23D	1494-0017**	75.00
		14D & 17D	1494-0025 #	160.00
		20D & 23D	1494-0026 #	150.00
		Hvy duty slide. Max 79.6 Kg (175 Lbs.)	20D & 23D only	1494-0016**
Brackets to adapt above slide kits to most Non-HP Racks	Std. Slide		1494-0023	45.00
	Hvy. Slide		1494-0042	65.00

*As a special kit, it is not included in Option 913. Order by part number only.

**Non-tilting slide

#Tilting slide

CABINETS: TRANSIT, OPERATING & COMBINING CASES

719

System II—Rack Mounting Accessories¹

For Sub Module Cabinets



If combined sub-module cabinets equal a full module width, use "Full Module" kits shown on previous page.

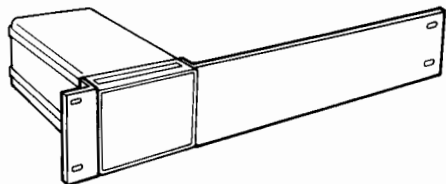

Rack Mounting Adapter Kit ²			
Description	Size	Part No.	Price
Kit includes one rack flange and one extension adapter ¼ MW. For mounting one System II cabinet ¼ MW, of 3½" height.	3½ H	5061-0073	\$37.00

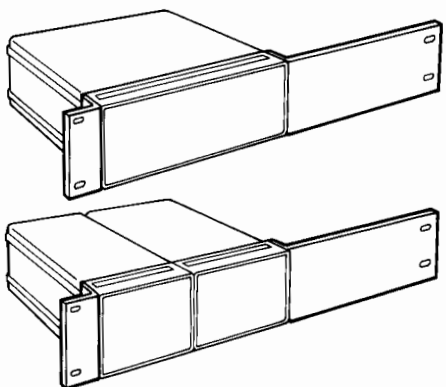

Rack Mounting Adapter Kit ²			
Description	Size	Part No.	Price
Kits include one rack flange and one extension adapter ¼ MW. For mounting one System II cabinet ½ MW or two cabinets ¼ MW, having these heights:	3½ H	5061-0072	\$34.00
	5¼ H	5061-0057	44.00
	7 H	5061-0060	44.00
	10½ H	5061-0066	72.50

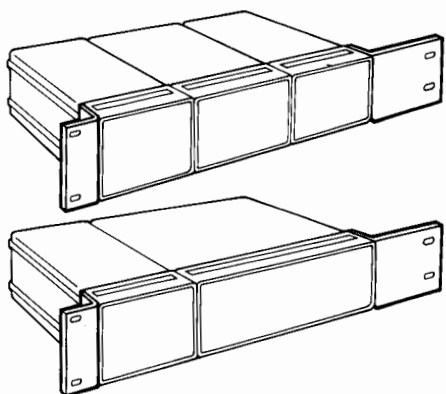

Rack Mounting Adapter Kit ²			
Description	Size	Part No.	Price
Kits include one rack flange and one extension adapter ¼ MW. For mounting one System II cabinet ½ MW together with one cabinet ¼ MW, or for mounting three cabinets ¼ MW together, having these heights.	3½ H	5061-0071 ³	\$32.00
	5¼ H	5061-0058 ³	60.00
	7 H	5061-0061 ³	57.50
	10½ H	5061-0067 ³	75.00

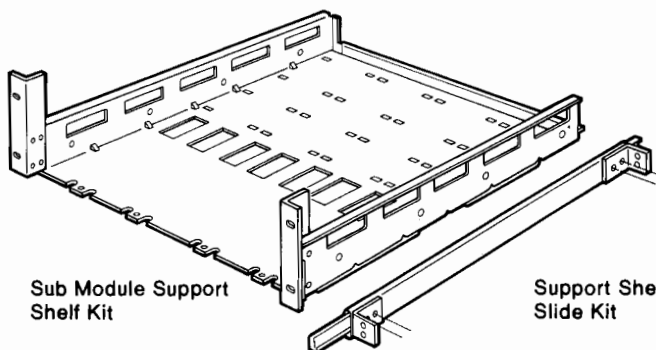

Sub Module Support Shelf Kit

Support Shelf Slide Kit

Support Shelves and Slide Kits			
Description	Size	Part No.	Price
Support Shelf for mounting one or more cabinets which are ½ MW or ¼ MW, and up to 20 D. Cabinet depths need not be equal, but heights must match support shelf height, except where top filler panels are used. Maximum shelf projection behind front mounting panel is 534 mm (21 in.). Maximum combined instrument weight is 22.7 kg (50 lb.)	3½ H	5061-0096	\$250.00
	5¼ H	5061-0097	280.00
	7 H	5061-0098	280.00
Slide Kit includes two slides for slide-mounting any of the above three support shelves in HP rack enclosures. Shelf can easily be removed from rack.		1494-0041	210.00

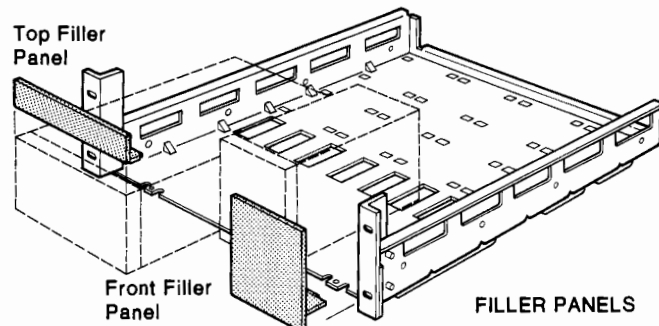

Top Filler Panel

Front Filler Panel

FILLER PANELS

Support Shelf Filler Panels			
Description	Size	Part No.	Price
For 3½ H support shelf partially filled with instruments, and having the following front panel space to fill:	¼ MW to fill	5061-2021	\$46.00
	½ MW to fill	5061-2022	31.00
	¾ MW to fill	5061-2023	36.00
For 5¼ H support shelf, and having the following front panel space to fill:	¼ MW to fill	5061-2024	\$52.50
	½ MW to fill	5061-2025	45.00
	¾ MW to fill	5061-2026	48.00
For 7 H support shelf, and having the following front panel space to fill:	¼ MW to fill	5061-2066	\$44.00
	½ MW to fill	5061-2027	48.00
For ¼ MW and having the following vertical space to fill:	1¾ H	5061-2035	\$39.00
	3½ H	5061-2036	40.00
For ½ MW and having the following vertical space to fill:	1¾ H	5061-2037	\$41.00
	3½ H	5061-2038	42.00

Note: Mounting hole patterns conform to EIA Standard RS-310-C for Racks, Panels, and Associated Equipment and the equivalent IEC standard

¹All kits are supplied with proper hardware for attaching kits to instruments but do not include rack front panel mounting screws.

²Cabinet lock-together kit (5061-0094) is also required whenever two, three or four sub-modules (¼ MW and or ½ MW) are to be joined in a configuration using rack mounting adapters or rack flanges. Also, sub-modules must be of equal depth.

³Requires two kits if one cabinet ½ MW is to be center-mounted.

Notice: SYSTEM II accessories will not fit SYSTEM I Cabinets. See Page 714.

CABINETS: TRANSIT, OPERATING & COMBINING CASES

SYSTEM I—Rack Hardware and Accessories

1051A

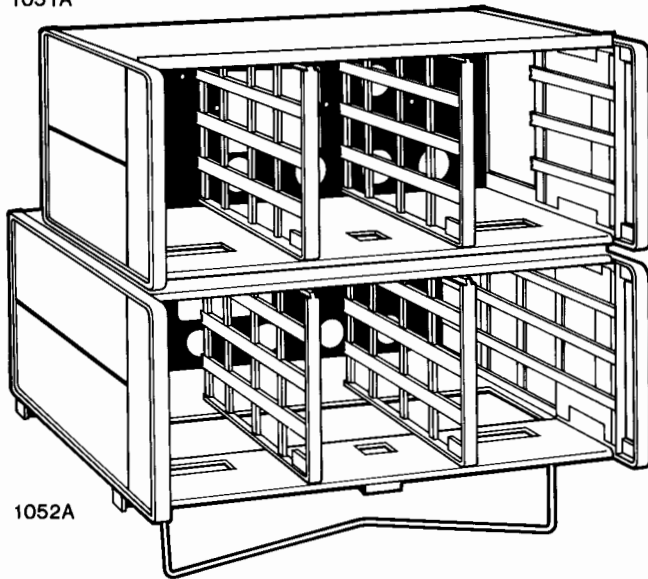

1052A

Combining Cases, 1051A, 1052A

Models 1051A and 1052A combining cases conveniently rack or bench mount combinations of small modular Hewlett-Packard SYSTEM-I instruments. In addition, these cases can be stacked on each other or on any full module instrument. Both cases accept 1/3 or 1/2 instrument modules, 130mm or 198 mm wide (5 1/8 or 7 25/32 inches). The basic difference is that the 1052A is 130 mm (5 1/8") deeper, and will accept modules up to 416mm deep (16 3/8"). The extra depth provides more space in the rear for wiring. The 1051A accepts instruments up to 286mm deep (11 1/4"). Each case is furnished with two dividers.

1051A, 1052A Specifications

Size	Price
1051A: 178 H x 482.6 W x 337 mm D (7"x19"x13 1/4").	\$450.00
1052A: 178 H x 482.6 W x 467 mm D (7"x19"x18 3/8").	450.00
Weight	
1051A: net, 4.5 kg (10 lb); shipping, 6.7 kg (15 lb)	
1052A: net, 5.4 kg (12 lb); shipping, 8.1 kg (18 lb)	
Opt 908: Rack Mount Kit	22.50
Opt 910: Extra Manual	1.00

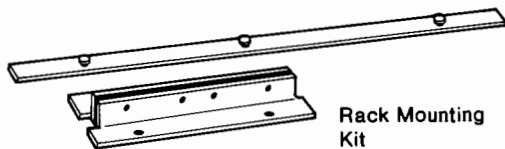

Rack Mounting Kit

Rack Mounting Kits, 5060-8739 to 5060-8744

With these kits all Hewlett-Packard products in full rack-width cabinets of the integral side frame-handle style (see 1051A, 1052A, Combining Cases above) can be easily prepared for rack mounting. Each kit contains two flanges, a filler strip, and mounting screws.

Rack Mounting Kit Ordering Information

Part Number	Nominal Cabinet Height		Price
	Millimetres	Inches	
5060-8739	88.1	3 1/2	\$27.00
5060-8740	132.6	5 1/4	23.50
5060-8741*	177	7	26.00
5060-8742	221.5	8 3/4	31.00
5060-8743	265.9	10 1/2	34.00
5060-8744	310.4	12 1/4	34.00

*Also used to rack mount Combining Kits 1051A & 1052A shown above.

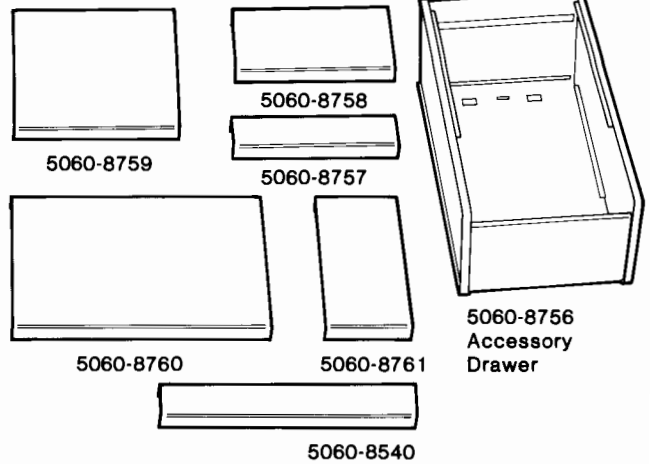

Filler Panels, 5060-8540, 5060-8757 to 5060-8761

Filler panels can be used to close off any leftover space after instruments are mounted in combining cases or adapter frames. Panels are made in a variety of widths and heights. Available widths are 1/8, 1/4, and 1/2 modules; heights are 1/4, 1/2 and the full 155 mm (6 3/8").

Specifications, Filler Panels

Part No.	Module Case Height x Width	Dimensions		Price
		Millimetres	Inches	
5060-8540	1/4 x 1/2	38 x 198	1 1/2 x 7 25/32	\$25.00
5060-8757	1/4 x 1/2	38 x 130	1 1/2 x 5 1/8	28.00
5060-8758	1/2 x 1/2	77 x 130	3 1/2 x 5 1/8	32.00
5060-8759	full x 1/2	155 x 130	6 3/8 x 5 1/8	24.50
5060-8760	full x 1/2	155 x 198	6 3/8 x 7 25/32	30.00
5060-8761	full x 1/4	155 x 63	6 3/8 x 2 3/8	29.00

Accessory Drawer, 5060-8756

The accessory drawer can be used in place of a 1/2 width filler panel to finish off unused space in the HP 1051A and 1052A Combining Cases. Size: 77 H x 130.2 W x 279.4 D (3 1/8" x 5 1/8" x 11")

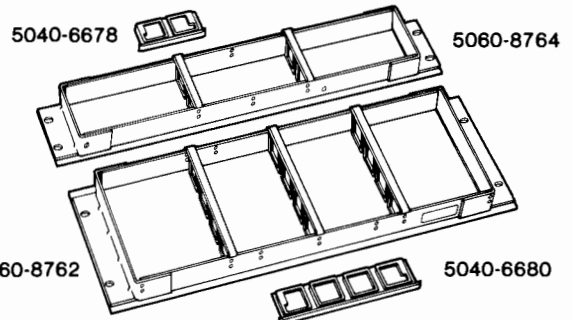

Rack Adapter Frames, 5060-8762, 5060-8764

These Frames can be used to hold combinations of 1/3 and 1/2 module-width HP instruments. Each frame is furnished with mounting hardware and dividers. Two models are available for different instrument heights. Adapter frames are for permanent or semipermanent rack mounting. Where quick removal and reinstallation of instruments is desirable, the 1051A and 1052A should be used.

Note: Instruments in full rack-width cabinets can be rack mounted with kits described above; they do not require rack adapter frames.

5060-8762: Equivalent to EIA 4U (7") rack height. Accepts instrument heights of 38, 77, or 155 mm (1 1/2", 3 1/8", 6 3/8"). **Price \$97.50**

5060-8764: Accepts only instrument heights of 38 or 77 mm (1 1/2", 3 1/8"). EIA 2U narrow (1 3/4") rack height. **Price \$135.00**

Extra Divider Panels

Part Number	For Frame	Price
5040-6678	5060-8764	\$10.50
5040-6680	5060-8762	12.50

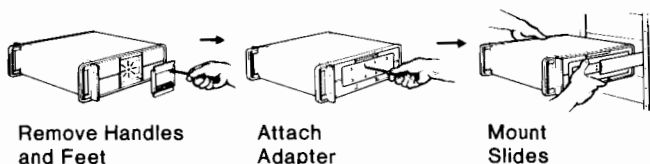

Rack Mount Slide Kits, 1490-0713 to 1490-0720

Cabinet Depth	Extension Length	Part Number ¹	Price
All Sizes	482.6 (19) ²	1490-0713*	\$125.00
All Sizes	635.0 (25) ³	1490-0714*	125.00
279.4 (11)	482.6 (19) ²	1490-0715#	170.00
406.4 (16)	482.6 (19) ²	1490-0716#	145.00
279.4 (11)	533.4 (21) ³	1490-0717#	225.00
406.4 (16)	558.8 (22) ³	1490-0718#	120.00
482.6 (19)	635.0 (25) ³	1490-0719#	185.00
558.8 (22)	635.0 (25) ³	1490-0720#	140.00

Notes: *Fixed type slide; #Tilt type slide
 1. Cabinet Adapters, below, must be added to slides
 2. Slide's stationary mounting depth: 408.4 (16)
 3. Slide's stationary mounting depth: 558.8 (22)
 Maximum instrument weight 31.7 Kg (70 lbs)

Cabinet Adapters for Above Slides 1490-0721 and 1490-0722

Cabinet Height	Part Number	Price
88.9 (3.5)	1490-0722	\$115.00
All others	1490-0721	110.00

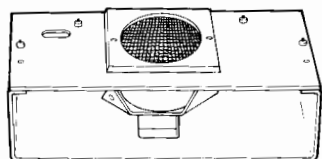

Cooling Kits, 5060-0789 and 5060-0796

These cooling kits are designed to be easily installed in the 1052A Combining Case. They can be installed in the 1051A, at the factory upon special request, but installation in the shorter case limits the depth of instruments the case can accept, and makes it impossible to use the accessory drawer.

Part Number	Price
5060-0789: 115 V, 50 to 60 Hz	\$625.00
5060-0796: 230 V, 50 to 60 Hz	625.00

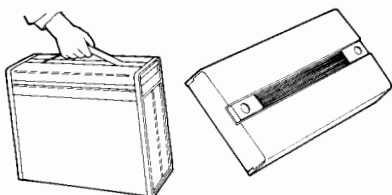

Control Panel Covers, 5060-8766 to 5060-8771

A series of control panel covers equipped with carrying handles are available for full rack width instruments. These covers protect instrument front panels and make rack mounted instruments tamper-proof.

One of these covers, the 5060-8768, fits both the 1051A and the 1052A Combining Case (page 692). Other covers are available to fit the six modular enclosures with front panel heights ranging from 88.1 to 310.4 mm (3 1/2" to 12 1/4"). Cover locks securely to front handles.

Part Number	Panel Height	Price
5060-8766:	88.1 mm (3 1/2") EIA panel height	\$235.00
5060-8767:	132.6 mm (5 1/4") EIA panel height	195.00
5060-8768:	177 mm (7") EIA panel height	215.00
5060-8769:	221.5 mm (8 3/4") EIA panel height	250.00
5060-8770:	265.9 mm (10 1/2") EIA panel height	250.00
5060-8771:	310.4 mm (12 1/4") EIA panel height	340.00

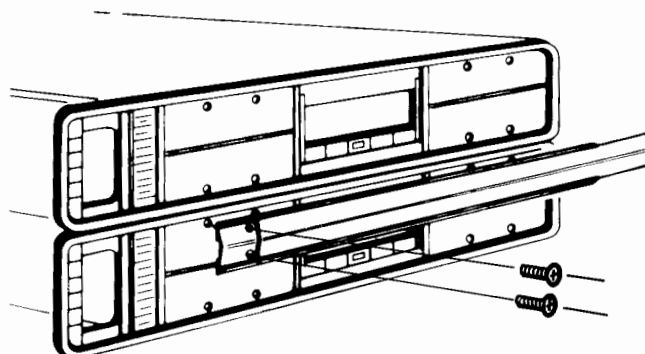

Joining Bracket Kits, 5060-8541 to 5060-8545

These kits join HP SYSTEM I instruments of the same width and length into easily handled single stacks. Each kit consists of two brackets, mounting hardware and trim. They are available to fit the three most common instrument depths:

Part Number	Instrument Depth	Price
5060-8541:	279 mm (11") EIA panel depth	\$120.00
5060-8543:	406 mm (16") EIA panel depth	110.00
5060-8545:	480 mm (19") EIA panel depth	185.00

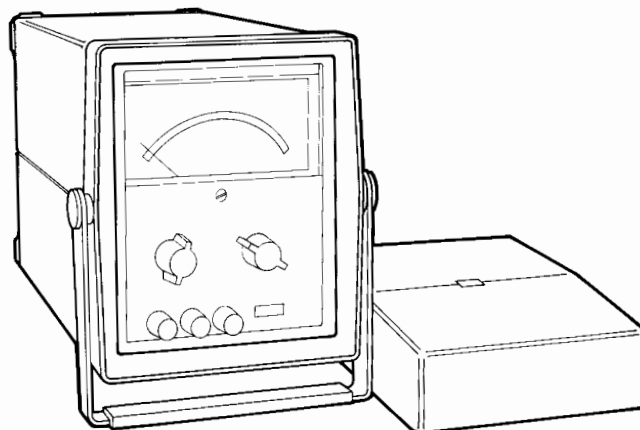

Module Instrument Cases, 11075A, 11076A

Rugged, high impact plastic instrument cases for HP 1/4 module instruments. Instruments can be operated, stored or carried in this splashproof case. Storage compartment for power cord in rear of case is accessible through a removable hatch. Front lid contains adequate storage space for cables, test leads, etc. The dual purpose tilt stand also serves as a carrying case handle. 11075A is 203 mm D (8"); 11076A is 279 mm (11") D.

Part Number	Price
11075A: Module Instrument Case	\$200.00
11076A: Module Instrument Case	200.00

RACK MOUNTING

SYSTEM I and SYSTEM II products can be mounted vertically in the same rack cabinet, or stacked on one another. However, the rack mounting hardware is not interchangeable, nor can SYSTEM I and SYSTEM II sub-modules be combined in the same horizontal rack space.

SYSTEM II module size and rack mounting hole spacing meet the specifications described in EIA Standard RS-310-C for Racks, Panels, and Associated Equipment.

CABINETS; TRANSIT, OPERATING & COMBINING CASES

Rugged Protection for Instruments

Modular instrument transit cases

Typical cushion
full size (425.5 mm) module

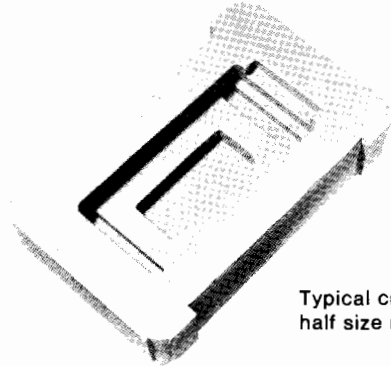

Typical cushion
half size module (197.6 mm wide)

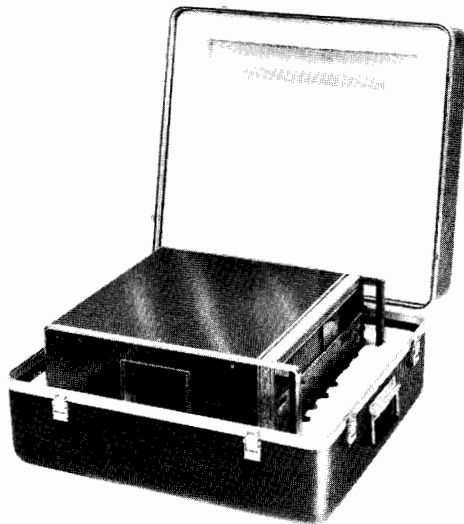

Typical System I transit case



V = Valise Style

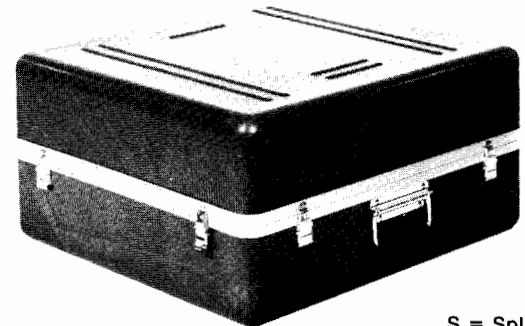

S = Split Style

Transit Case Styles

The HP transit cases are rugged protective outer shells for use when instruments must be frequently transported and used away from laboratory conditions. They are molded of strong fiberglass-reinforced plastic. All are sealed tightly with O-ring gaskets and clamping latches. They are rainproof under the test conditions of MIL-STD-108. Carrying handles are conveniently placed, fold flat when not in use.

Transit cases are typically provided with foam cushions, custom formed to fit the standard HP modular cabinets. This arrangement provides maximum protection against damage from handling, dropping, or crushing. A selection of case sizes is available to accommodate nearly any instrument and combination of accessories.

Transit Cases - System I

Instrument Size (inches)			Instrument Size (mm)			Case Size* (inches) Not including hardware			Case size (mm) Not including hardware			Style	Shipping Weight		HP Part Number	Prices	
H	W	D	H	W	D	L	W	D	L	W	D		Lbs.	kg		1-4	5-up
3 1/2	16 3/4	13 1/4	88.1	425.5	336.6	20 1/2	17 1/2	9	520.7	444.5	228.6	V	15	68	9211-1288	\$380	\$345
5 1/4	16 3/4	13 1/4	132.6	425.5	336.6	20 1/2	17 1/2	10 3/4	520.7	444.5	273.1	V	16	73	9211-1289	\$390	\$360
7	16 3/4	13 1/4	177.0	425.5	336.6	20 1/2	17 1/2	12 1/2	520.7	444.5	317.5	V	17	77	9211-1290	\$390	\$360
8 3/4	16 3/4	13 1/4	221.5	425.5	336.6	20 1/2	17 1/2	14 1/4	520.7	444.5	362.0	S	18	82	9211-1291	\$420	\$380
3 1/2	16 3/4	18 3/8	88.1	425.5	466.7	23	21	9	584.2	533.4	228.6	V	18	82	9211-1292	\$400	\$370
5 1/4	16 3/4	18 3/8	132.6	425.5	466.7	23	21	10 3/4	584.2	533.4	273.1	V	19	86	9211-0839	\$420	\$380
7	16 3/4	18 3/8	177.0	425.5	466.7	23	21	12 1/2	584.2	533.4	317.5	V	20	91	9211-1293	\$430	\$390
8 3/4	16 3/4	18 3/8	221.5	425.5	466.7	23	21	14 1/4	584.2	533.4	362.0	V	21	95	9211-1294	\$430	\$390
10 1/2	16 3/4	18 3/8	265.9	425.5	466.7	23	21	16	584.2	533.4	406.4	S	22	100	9211-1295	\$440	\$400
12 1/4	16 3/4	18 3/8	310.4	425.5	466.7	23	21	17 3/4	584.2	533.4	450.9	S	22	100	9211-1313	\$450	\$410
5 1/4	16 3/4	21 3/8	132.6	425.5	542.9	25 1/2	23 1/2	10 3/4	647.7	596.9	273.1	V	24	110	9211-1296	\$440	\$400
7	16 3/4	21 3/8	177.0	425.5	542.9	25 1/2	23 1/2	12 1/2	647.7	596.9	317.5	V	24	110	9211-1735	\$450	\$410
12 1/4	16 3/4	24 3/8	310.4	425.5	542.9	24	19	29 3/4	609.6	482.6	755.7	S	32	150	9211-1297	\$530	\$480
6 1/2	5 1/8	8	165.1	130.2	203.2	14 1/4	9	11 1/4	362.0	228.6	285.8	V	8	36	9211-1317	\$330	\$300
6 1/2	5 1/8	11	165.1	130.2	279.4	16 3/8	10 3/8	11 1/4	428.6	263.5	285.8	V	11	50	9211-1318	\$340	\$310
6 1/2	7 3/8	8	165.1	196.9	203.2	16 3/8	10 3/8	11 1/4	428.6	263.5	285.8	V	11	50	9211-1316	\$340	\$310
6 1/2	7 3/8	11	165.1	196.9	279.4	16 3/8	10 3/8	11 1/4	428.6	263.5	285.8	V	11	50	9211-1315	\$340	\$310
6 1/2	7 3/8	16	165.1	196.9	406.4	20 1/2	12 1/2	11 1/4	520.7	317.5	285.8	V	15	68	9211-1734	\$380	\$345
6 1/2	10 1/2	11	165.1	266.7	279.4	16 1/2	14 1/2	8 1/2	419.1	368.3	215.9	V	12	55	9211-1895	\$350	\$320

Full-Module Width Instruments

Transit Cases-System II:

Appropriate Front Handle Kit (HP Part Number 5061-0088 to -0093) must be installed on instruments for adequate protection.

Dimensions in inches and mm

Instrument size			Case size* (not including hardware)									Style	HP Part Number	Prices					
in	H	mm	in	W	mm	in	D	mm	in	L	mm			in	W	mm	in	D	mm
3 1/2	88.1	16 3/4	425.5	13 3/4	349.3	23	584.2	21	533.4	8 3/4	222.3	V	9211-2642	\$440	\$390				
5 1/4	132.6	16 3/4	425.5	13 3/4	349.3	23	584.2	21	533.4	10 1/2	266.7	V	9211-2643	\$450	\$400				
7	177.0	16 3/4	425.5	13 3/4	349.3	23	584.2	21	533.4	12 1/4	311.2	V	9211-2644	\$460	\$410				
8 3/4	221.5	16 3/4	425.5	13 3/4	349.3	23	584.2	21	533.4	14	355.6	V	9211-2645	\$500	\$450				
10 1/2	265.9	16 3/4	425.5	13 3/4	349.3	23	584.2	21	533.4	15 3/4	400.1	S	9211-2646	\$510	\$460				
12 1/4	310.4	16 3/4	425.5	13 3/4	349.3	23	584.2	21	533.4	17 1/2	444.5	S	9211-2647	\$530	\$480				
3 1/2	88.1	16 3/4	425.5	16 3/4	425.5	24 1/2	622.3	24 1/2	622.3	8 3/4	222.3	V	9211-2648	\$460	\$410				
5 1/4	132.6	16 3/4	425.5	16 3/4	425.5	24 1/2	622.3	24 1/2	622.3	10 1/2	266.7	V	9211-2649	\$500	\$450				
7	177.0	16 3/4	425.5	16 3/4	425.5	24 1/2	622.3	24 1/2	622.3	12 1/4	311.2	V	9211-2650	\$530	\$480				
8 3/4	221.5	16 3/4	425.5	16 3/4	425.5	24 1/2	622.3	24 1/2	622.3	14	355.6	S	9211-2651	\$530	\$480				
10 1/2	265.9	16 3/4	425.5	16 3/4	425.5	24 1/2	622.3	24 1/2	622.3	15 3/4	400.1	S	9211-2652	\$550	\$500				
12 1/4	310.4	16 3/4	425.5	16 3/4	425.5	28	711.2	24	609.6	17 1/2	444.5	S	9211-2653	\$590	\$540				
3 1/2	88.1	16 3/4	425.5	19 3/4	501.7	28	711.2	24	609.6	8 3/4	222.3	V	9211-2654	\$500	\$450				
5 1/4	132.6	16 3/4	425.5	19 3/4	501.7	28	711.2	24	609.6	10 1/2	266.7	V	9211-2655	\$530	\$480				
7	177.0	16 3/4	425.5	19 3/4	501.7	28	711.2	24	609.6	12 1/4	311.2	V	9211-2656	\$540	\$490				
8 3/4	221.5	16 3/4	425.5	19 3/4	501.7	28	711.2	24	609.6	14	355.6	S	9211-2657	\$550	\$500				
10 1/2	265.9	16 3/4	425.5	19 3/4	501.7	28	711.2	24	609.6	15 3/4	400.1	S	9211-2658	\$580	\$530				
12 1/4	310.4	16 3/4	425.5	19 3/4	501.7	28	711.2	24	609.6	17 1/2	444.5	S	9211-2659	\$590	\$540				
3 1/2	88.1	16 3/4	425.5	22 3/4	577.9	30 1/2	774.7	24 1/2	622.3	8 3/4	222.3	V	9211-2660	\$530	\$480				
5 1/4	132.6	16 3/4	425.5	22 3/4	577.9	30 1/2	774.7	24 1/2	622.3	10 1/2	266.7	V	9211-2661	\$540	\$490				
7	177.0	16 3/4	425.5	22 3/4	577.9	30 1/2	774.7	24 1/2	622.3	12 1/4	311.2	S	9211-2662	\$570	\$520				
8 3/4	221.5	16 3/4	425.5	22 3/4	577.9	30 1/2	774.7	26 1/4	666.8	14	355.6	S	9211-2663	\$610	\$550				
10 1/2	265.9	16 3/4	425.5	22 3/4	577.9	30 1/2	774.7	26 1/4	666.8	15 3/4	400.1	S	9211-2664	\$630	\$580				
12 1/4	310.4	16 3/4	425.5	22 3/4	577.9	30 1/2	774.7	26 1/4	666.8	17 1/2	444.5	S	9211-2665	\$660	\$600				

*For overpack size to hold case add 1 1/4", 31.8 mm, to L & W and 1 1/4", 6.4 mm to D.

Half-and Quarter-module Width Instruments

Transit Cases-System II:

Dimensions in inches and mm

Instrument size			Case size* (not including hardware)									Style	HP Part Number	Prices					
in	H	mm	in	W	mm	in	D	mm	in	L	mm			in	W	mm	in	D	mm
3 1/2	88.1	8 3/8	204.2	10 3/4	273.1	14 7/8	377.8	13 3/4	349.3	7 1/2	190.5	v	9211-2666	\$350	\$320				
5 1/4	132.6	8 3/8	204.2	10 3/4	273.1	14 7/8	377.8	13 3/4	349.3	9 1/4	235.0	v	9211-2667	\$350	\$320				
7	177.0	8 3/8	204.2	10 3/4	273.1	14 7/8	377.8	13 3/4	349.3	11	279.4	v	9211-2668	\$350	\$320				
8 3/4	221.5	8 3/8	204.2	10 3/4	273.1	14 7/8	377.8	13 3/4	349.3	12 3/4	323.9	v	9211-2669	\$370	\$335				
10 1/2	265.9	8 3/8	204.2	10 3/4	273.1	14 7/8	377.8	13 3/4	349.3	14 1/2	368.3	v	9211-2670	\$370	\$335				
3 1/2	88.1	8 3/8	204.2	13 3/4	349.3	20	508.0	13 1/2	342.9	7 1/2	190.5	v	9211-2671	\$370	\$335				
5 1/4	132.6	8 3/8	204.2	13 3/4	349.3	20	508.0	13 1/2	342.9	9 1/4	235.0	v	9211-2672	\$370	\$335				
7	177.0	8 3/8	204.2	13 3/4	349.3	20	508.0	13 1/2	342.9	11	279.4	v	9211-2673	\$370	\$335				
8 3/4	221.5	8 3/8	204.2	13 3/4	349.3	20	508.0	13 1/2	342.9	12 3/4	323.9	v	9211-2674	\$380	\$345				
10 1/2	265.9	8 3/8	204.2	13 3/4	349.3	20	508.0	13 1/2	342.9	14 1/2	368.3	v	9211-2675	\$390	\$360				
3 1/2	88.1	8 3/8	204.2	16 3/4	425.5	20	508.0	13 1/2	342.9	7 1/2	190.5	v	9211-2676	\$370	\$335				
5 1/4	132.6	8 3/8	204.2	16 3/4	425.5	20	508.0	13 1/2	342.9	9 1/4	235.0	v	9211-2677	\$370	\$335				
7	177.0	8 3/8	204.2	16 3/4	425.5	20	508.0	13 1/2	342.9	11	279.4	v	9211-2678	\$380	\$345				
8 3/4	221.5	8 3/8	204.2	16 3/4	425.5	20	508.0	13 1/2	342.9	12 3/4	323.9	v	9211-2679	\$380	\$345				
10 1/2	265.9	8 3/8	204.2	16 3/4	425.5	20	508.0	13 1/2	342.9	14 1/2	368.3	v	9211-2680	\$390	\$360				
3 1/2	88.1	8 3/8	204.2	19 3/4	501.7	24 1/4	616.0	13	330.2	7 1/2	190.5	v	9211-2681	\$370	\$335				
5 1/4	132.6	8 3/8	204.2	19 3/4	501.7	24 1/4	616.0	13	330.2	9 1/4	235.0	v	9211-2682	\$380	\$345				
7	177.0	8 3/8	204.2	19 3/4	501.7	24 1/4	616.0	13	330.2	11	279.4	v	9211-2683	\$390	\$360				
8 3/4	221.5	8 3/8	204.2	19 3/4	501.7	24 1/4	616.0	13	330.2	12 3/4	323.9	v	9211-2684	\$420	\$380				
10 1/2	265.9	8 3/8	204.2	19 3/4	501.7	24 1/4	616.0	13	330.2	14 1/2	368.3	v	9211-2685	\$430	\$390				
3 1/2	88.1	4 1/8	104.8	10 3/4	273.1	14	355.6	10	254.0	6 1/2	165.1	v	9211-2686	\$330	\$300				
5 1/4	132.6	4 1/8	104.8	10 3/4	273.1	14	355.6	10	254.0	8 1/4	209.6	v	9211-2687	\$340	\$310				
7	177.0	4 1/8	104.8	10 3/4	273.1	14	355.6	10	254.0	10	254.0	v	9211-2688	\$350	\$320				
3 1/2	88.1	4 1/8	104.8	13 3/4	349.3	16 1/8	428.6	10 1/2	266.7	6 1/2	165.1	v	9211-2689	\$340	\$310				
5 1/4	132.6	4 1/8	104.8	13 3/4	349.3	16 1/8	428.6	10 1/2	266.7	8 1/4	209.6	v	9211-2690	\$350	\$320				
7	177.0	4 1/8	104.8	13 3/4	349.3	16 1/8	428.6	10 1/2	266.7	10	254.0	v	9211-2691	\$350	\$320				
3 1/2	88.1	4 1/8	104.8	16 3/4	425.5	20 1/4	514.4	11 3/4	298.5	6 1/2	165.1	v	9211-2692	\$350	\$320				
5 1/4	132.6	4 1/8	104.8	16 3/4	425.5	20 1/4	514.4	11 3/4	298.5	8 1/4	209.6	v	9211-2693	\$350	\$320				
7	177.0	4 1/8	104.8	16 3/4	425.5	20 1/4	514.4	11 3/4	298.5	10	254.0	v	9211-2694	\$370	\$335				

*For overpack size to hold case add 1 1/4", 31.8 mm, to L & W and 1/2", 6.4 mm to D

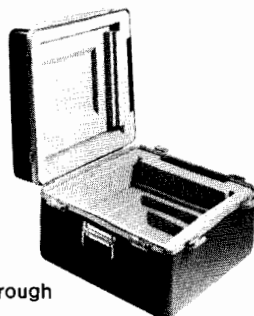

Cases for other size instruments or special applications are available through HP Service Center

Caster kit 1490-0913 can be field installed to provide (4) 3 1/4" diameter swivel casters mounted with quarter turn fasteners

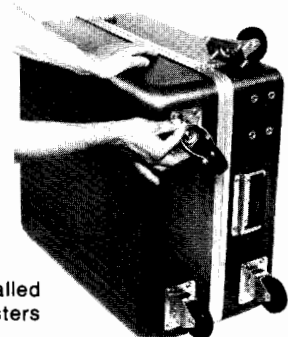

CABINETS; TRANSIT, OPERATING & COMBINING CASES

Operating Cases: Rugged Protection for Instruments

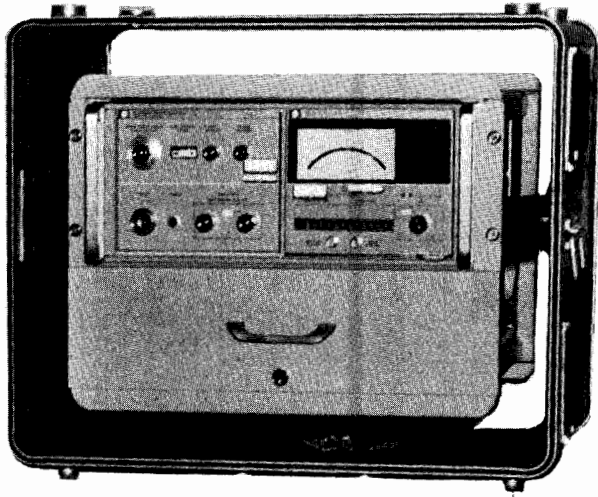

Operating Case with instrument and drawer.

HP cases are rugged protective outer shells for use when instruments must be frequently transported and used away from laboratory conditions. They are molded of strong fiberglass and have conveniently placed carrying handles that fold flat when not in use. All are sealed tightly with O-ring gaskets and clamping latches and are rain-proof under the test conditions of MIL-STD-108.

Operating cases are equipped internally with shock-mounted frames that accept any standard 19-inch rack-mounting instruments up to the maximum height of the frames. This arrangement offers the convenience of operation without removing the instrument from its carrying case. At the same time, environmental protection is afforded.

More than one instrument may be combined in a single operating case for convenience in setting up and operating. Patch-cable interconnections may then be left in place within the case, so that when the unit has been transported to its place of use the covers are removed and the instruments inside are ready to put into use with a minimum of delay.

Drawers are available in three different heights so that small accessories, tools, etc., can be kept inside the case with the instruments. Fitted foam cushions can be made up to accommodate nearly any shape articles.

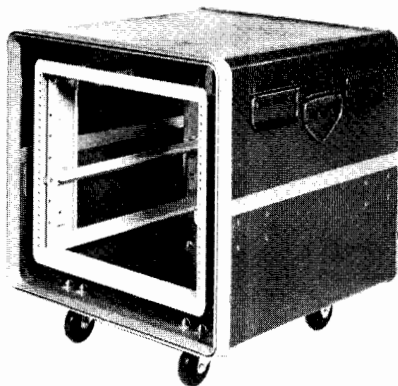

A caster kit is available to fit the operating case allowing it to become a mobile rack. Once the kit is installed, the casters themselves may be attached or removed in seconds. With casters removed, the attaching hardware adds nothing to the overall dimensions of the case.

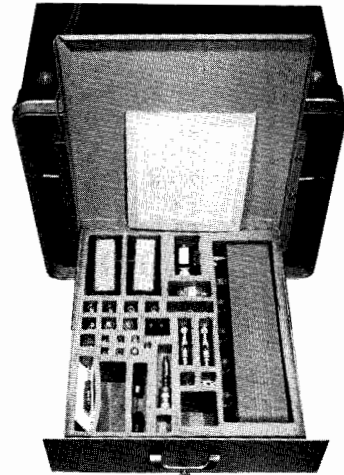

Fitted foam drawer cushions to accommodate various HP accessory combinations are available.

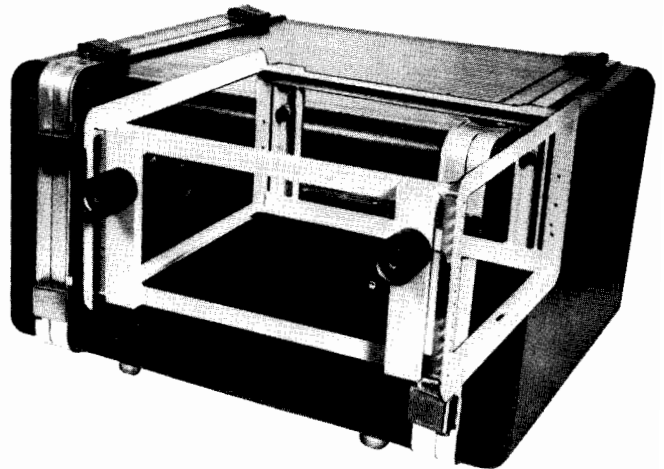

Equipped with elastomeric shock mounts, these enclosures provide outstanding shock and vibration attenuation. A set of standard shock mounts can be provided for any equipment weight and fragility.

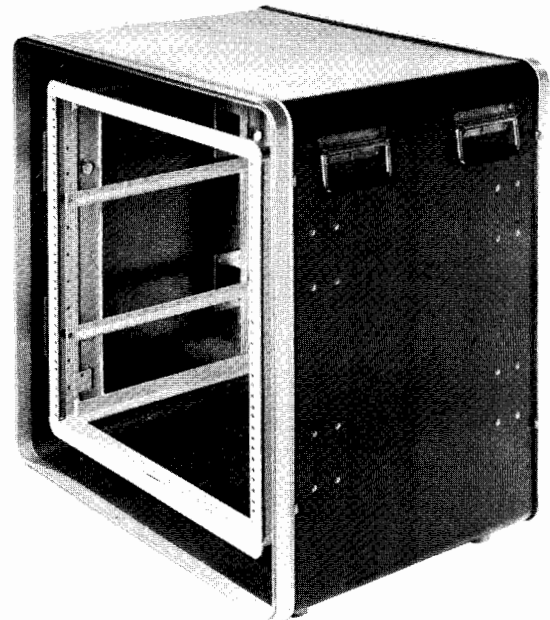

Operating Case showing T-Bars installed.

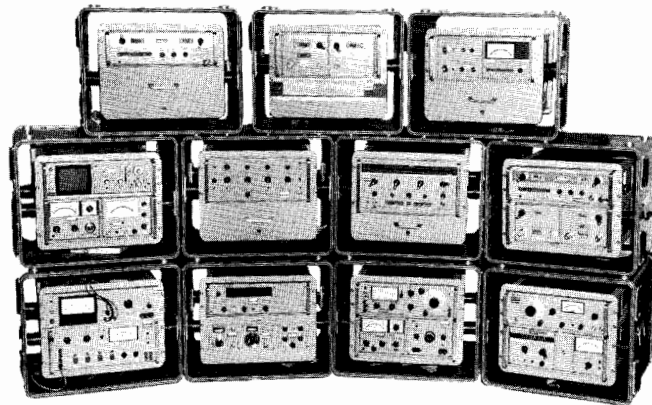

Nominal rack ht. in	ISO	Instrument Weight				Case Size (inches) Not including hardware			Case Size (mm) Not including hardware			Weight				HP Part Number	Prices	
		Maximum lb	kg	Minimum lb	kg	W	H	D	W	H	D	Case		Shipping			1 to 4	5 or more
5¼	3U	75	34.0	20	9.1	24.0	10.8	28.5	609.6	274.3	723.9	40	18.1	50	28.7	9211-1302	\$1,350	\$1,200
8¾	5U	75	34.0	20	9.1	24.0	15.2	27.0	609.6	381.0	685.8	46	20.9	56	25.4	9211-1303	\$1,450	\$1,300
10½	6U	130	59.0	30	13.6	24.0	17.0	28.5	609.6	431.8	723.9	53	24.0	64	29.0	9211-2635	\$1,650	\$1,500
12¼	7U	100	45.4	25	11.3	24.0	18.9	28.5	609.6	480.1	723.9	55	24.9	65	29.5	9211-1163	\$1,750	\$1,600
14	8U	130	59.0	30	13.6	24.0	20.6	28.5	609.6	523.2	723.9	57	25.9	70	37.8	9211-1241	\$1,800	\$1,650
15¾	9U	130	59.0	30	13.6	24.0	22.4	28.5	609.6	569.0	723.9	60	27.2	75	34.0	9211-1242	\$2,000	\$1,800
17½	10U	130	59.0	30	13.6	24.0	24.1	28.5	609.6	612.1	723.9	64	29.0	80	36.3	9211-1243	\$2,000	\$1,800
19¼	11U	130	59.0	30	13.6	24.0	25.9	28.5	609.6	657.9	723.9	69	31.3	85	38.6	9211-1244	\$2,050	\$1,850
21	13U	250	113.4	50	22.7	24.0	28.1	28.5	609.6	711.2	723.9	75	34.0	90	40.8	9211-1245	\$2,100	\$1,900
22¾	14U	250	113.4	50	22.7	24.0	29.75	28.5	609.6	749.3	723.9	77	34.9	95	43.1	9211-2636	\$2,150	\$1,950
24½	15U	250	113.4	50	22.7	24.0	31.0	28.5	609.6	787.4	723.9	80	36.3	100	45.4	9211-1911	\$2,200	\$2,000
26¼	16U	250	113.4	50	22.7	24.0	33.1	28.5	609.6	782.3	723.9	83	37.6	105	47.6	9211-2637	\$2,200	\$2,000
28	17U	250	113.4	50	22.7	24.0	35.1	28.5	609.6	876.3	723.9	87	39.5	110	49.9	9211-2638	\$2,250	\$2,050
29¾	18U	250	113.4	50	22.7	24.0	36.4	28.5	609.6	924.6	723.9	90	40.8	115	52.2	9211-2639	\$2,300	\$2,100
31½	19U	250	113.4	50	22.7	24.0	37.6	28.5	609.6	965.2	723.9	94	42.6	120	54.4	9211-2640	\$2,300	\$2,100
33¼	20U	250	113.4	50	22.7	24.0	39.9	28.5	609.6	995.7	723.9	97	44.0	125	56.7	9211-1713	\$2,450	\$2,250
47¼	21U	320	145.2	70	31.8	24.0	53.9	28.5	609.6	1369.1	723.9	140	63.5	175	79.4	9211-2641	\$3,900	\$3,500

Standard Features

Inner rack frame with provision for infinitely adjustable T-bar instrument support brackets. Standard 20" depth.

Inner rack frame with RETMA hole pattern drilled in rear rails. Standard color: tan

Special Features Available

- A. Mating feet for stacking one case on top of another. \$40
- B. Special color other than tan. Please specify. \$30
- C. Modified inner rack frame depth. Standard depth 20" from front panel mounting surface to rear surface of frame. This option includes an appropriate change in the overall depth of the enclosure. Please specify desired inner frame depth. Maximum 23", minimum 12". \$90
- D. Chassis trak C-300 instrument slide pair to mount on either side of inner frame using RETMA hole pattern drilled in front and rear rails. \$65
- E. Special shock mounts for unusual instrument weights. Please specify weights. \$30
- F. Increased front cover depth. Maximum depth 6". Please specify. \$185
- G. Increased rear cover depth. Maximum depth 6". Please specify. \$185
- H. Latches recessed into the surface of the case. \$185
- I. Handles recessed into the surface of the case. \$65
- J. Hermetically sealed case tested by the hot water method. \$65
- K. MIL-C-4150 certification with the exception of design and preproduction testing. Case will have increased wall thickness, hardware anodized to military specification, and will be hermetically tested using the hot water method. \$215

N/C

N/C

Special Features Available (Continued)

- L. Addition of an automatic pressure relief valve. \$40
- Manual pressure relief valve. N/C
- M. Addition of four permanently mounted, 3½" diameter swivel casters. \$90
- N. Addition of four removable, 3½" diameter swivel casters. Also available in kit form P/N 1490-0913. \$110
- O. Addition of two aluminum hat-section skids to the case bottom. \$90
- P. Addition of lift rings to either side of the case. \$40
- Q. 3½ H (88.1 mm) Drawer with ball bearing slides. \$210
- R. 5¼ H (132.6 mm) Drawer with ball bearing slides. \$210
- S. 7 H (177 mm) Drawer with ball bearing slides. \$210

Accessories (When Ordered Separately)

- 9211-1164** 3½ H (88.1 mm) Drawer with ball bearing slides. \$390
- 9211-1165** 5¼ H (132.6 mm) Drawer with ball bearing slides. \$400
- 9211-1166** 7 H (177 mm) Drawer with ball bearing slides. \$410
- 0950-0122** AC power receptacle strip with four outlets mounted on bottom rear of inner rack frame. Power cord 1 m (3.3') long, NEMA connectors. \$100
- 9211-1173** Pair T-Bar instrument support brackets. \$50
- 1490-0913** Caster kit, four removable 3½" (88.9 mm) swivel casters. \$220

On special order, complete transportable field instrument groups can be assembled to suit individual requirements. On request, cases can be fabricated that meet the environmental requirements of Military Specifications.

SOLID STATE COMPONENTS

Optoelectronics

Hewlett-Packard Optoelectronic Components offer exceptional performance in consumer, industrial, military and OEM equipment. With sophisticated semiconductor processing equipment and the industry's most extensive hybrid thin-film microcircuit manufacturing facilities, Hewlett-Packard applies newly developed technologies to component manufacturing. This results in high performance solid state numeric and alphanumeric readouts, display systems, plus LED lamps, light bars, fiber optics, emitter/detector systems, PIN photodiodes and optocouplers.

Fiber Optics

Fiber optics has emerged as a practical, cost-effective technology for data communications. Pulses of light travel down hair-thin fibers replacing electrical signals transmitted over copper wire. The light signals are impervious to electrical or magnetic interference and therefore generate no electrical or magnetic noise. This makes them ideal for linking computers or control devices and their peripherals in different environments such as those found in factories, aircraft, hospitals and large power plants.

Elements of HP's fiber optic product family include modular optical transmitters and receivers, single fiber optical connectors, compatible optical fiber cables, and a connector assembly tooling kit. HP's newest addition to the fiber optic family is a low cost, short distance (5-metre) Snap-in Fiber Optic Link. This Link is also TTL compatible.

Currently, Hewlett-Packard's fiber optic system, HFBR-0010, is fully specified and guaranteed for transmitting any pattern of digital information, from dc to 10 Mbaud, to 1000 metres.

Emitters/Detectors

Hewlett-Packard has entered the fast growing bar code data entry market with the introduction of two Digital Bar Code Wands. The HP Wands are designed to read black and white bar codes and most colors. The Wands consist of a precision integrated optical sensor, amplification, and an analog to digital converter. They are fully compatible with TTL and CMOS circuitry.

In addition to the complete bar code system described above, Hewlett-Packard also offers the designer the choice of both integrated and discrete emitter/detector components. A genuine unfulfilled need is addressed by HP's high resolution optical sensor, the HEDS-1000. The small, self contained reflective sensor combines a light source and detector with focused optics in a single package. This unique component can detect an object as fine as a human hair as well as the precise edge of large objects such as paper or printed lines and marks. It therefore becomes ideally suited in such applications as pattern recognition, optical limit switching, tachometry, defect detection, and bar code scanning.

Hewlett-Packard also offers high radiant intensity emitters in the near infrared range. These emitters are available in both floodlight and spotlight configurations, and are ideally suited for use in optical transducers, optical encoders, smoke detectors, and fiber optic transmitters.



Snap-In Fiber Optic Link

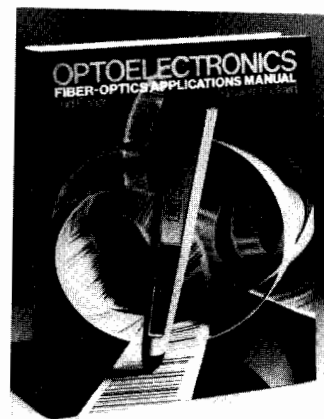

HPBK-2000



Digital Bar Code Wands

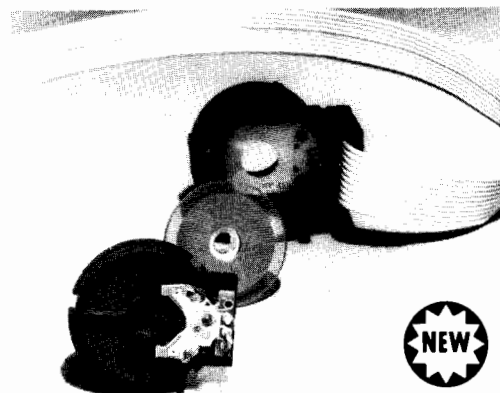

Optical Shaft Encoder

Hewlett-Packard PIN photodiodes are excellent light detectors with an exceptionally fast response of 1 ns, wide spectral response from near infrared to ultraviolet, and wide range linearity (constant efficiency over 6 decades of amplitude). Some applications include fiber optic receivers, laser scanners, range finders, and medical diagnostic equipment. High reliability test programs are also available.

Optical Shaft Encoders

As an extension of our emitter/detector systems capability, Hewlett-Packard is developing optical shaft encoding systems. HP's optical encoder is a motion sensor that provides a digital link between mechanical shaft rotation and the control electronics in a closed loop servo system. Encoders are used in a wide variety of applications varying from computer peripherals and professional audio-video systems to automated production equipment.

Optocouplers

Hewlett-Packard's family of optocouplers provides economical, high performance solutions to problems caused by ground loops and induced common mode noise for both analog and digital applications in commercial, industrial, and military products.

Hewlett-Packard's approach toward integrated output detectors provides performance not found in conventional photo-

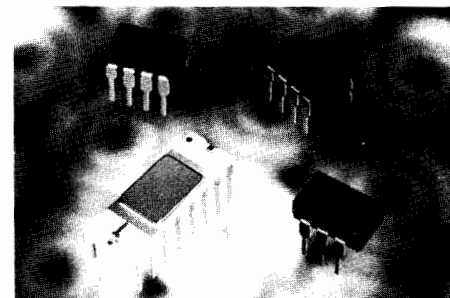

Full-Range Optocoupler Line

transistor output optocouplers. With 3000 VDC isolation, the types of optocouplers available include high speed devices capable of 10M bits and high gain devices which are specified at 400% CTR at input currents as low as 0.5mA. In addition, highly linear optocouplers are useful in analog applications.

HP's AC/DC to logic interface optocoupler contains an input IC for threshold detection processing electrical signals before they are passed onto the LED's. This reduces a user's external component count for sensing an AC or DC signal.

Most of these devices are available in dual versions, as well as in hermetic DIP packages. For military users, Hewlett-Packard has an established hi-rel capability.

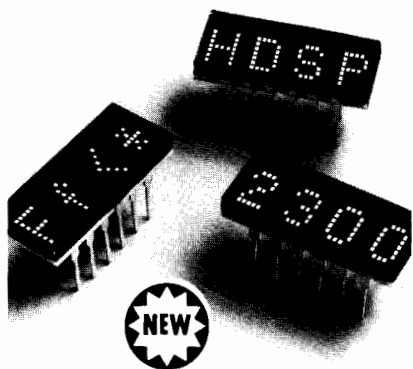

Yellow Alphanumeric Display

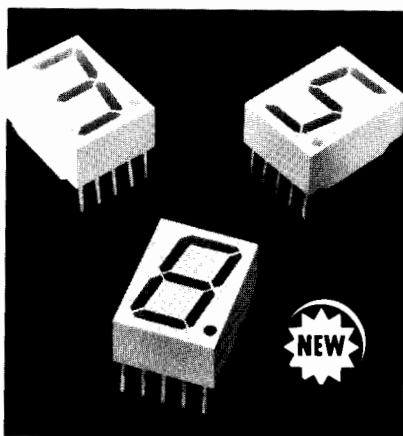

14.1mm (.56") LED Display

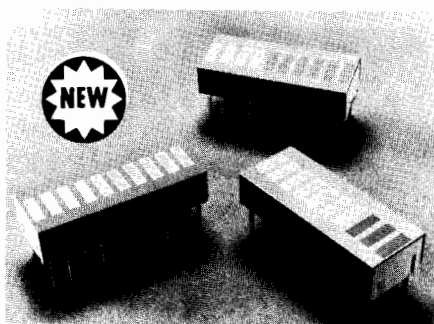

10-Element Bar Graph Array

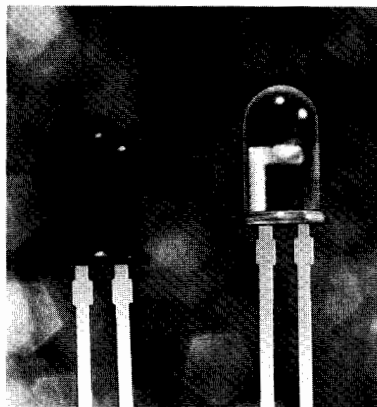

5-V and 12-V Resistor Lamps

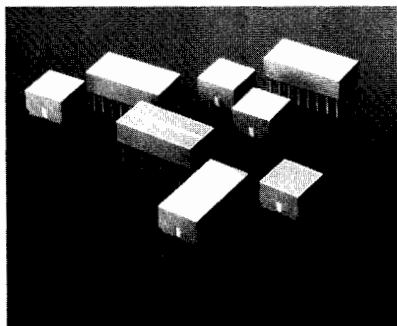

Light Bar Modules

Solid State Displays

Hewlett-Packard's completely supported alphanumeric display systems allow freedom from costly display maintenance, require very low operating power, and minimize the interaction normally required for alphanumeric displays. The display systems are TTL compatible, require a single 5 V supply, and easily interface to a keyboard or micro-processor. They are ideally suited for instrumentation, process control equipment, and terminal applications.

Hewlett-Packard's four character 5 x 7 dot matrix displays with on-board shift registers and constant current drivers are the answer

for applications that require compact packages, end-stackability, and proven ruggedness and reliability. Available with character heights of 0.150", 0.200", and 0.270", the displays come in three colors: red, high efficiency red, and yellow. The 0.200" device is also vertically stackable. High reliability screening can be arranged.

Available in four- and eight-character end-stackable modules are Hewlett-Packard's 18-segment solid state LED alphanumeric displays. Magnifications of the LED by an integral lens results in a character size of up to 3.8mm (0.15") making these displays ideal for use in computer peripheral products, automotive instrument panels, portable terminals and systems requiring low power consumption.

Low cost numeric displays, packaged single or clustered, are available in character heights from 0.22" to 0.8". Low power small character displays have been designed for portable instrumentation and calculator applications. Other seven-segment display units are available in red, yellow, and green colors for use in instrumentation, point of sale terminals, and TV indicator applications. High power, sunlight viewable, large character displays are readily adapted to outdoor terminals, gas pumps and agricultural instrumentation. For these displays, Hewlett-Packard has successfully integrated a gray package design with untinted segments. This results in excellent bright ambient contrast enhancement.

Integrated numeric and hexadecimal displays (with on-board IC's), available in plastic and hermetic packages and in colors solve the designer's decoding/driving problem. These displays have been designed for low cost and ease of application in a wide range of environments.

Bar Graph Arrays

Hewlett-Packard's indicator product line has expanded to include a Ten-Element Bar Graph Array. This compact new array allows information to be displayed in easily recognizable bar graph form. It is also compatible with most HP front panel display components.

Solid State Lamps

Light Emitting Diode Light Bar Modules are Hewlett-Packard's answer to the problem of how to effectively backlight legends. The Light Bar's large, uniformly illuminated surface provides a bright light source available in high efficiency red, yellow, or green. The universal pin-out arrangement allows connecting in parallel, series, or series/parallel configurations. Hewlett-Packard's Light Bar Modules come in four sizes, are available in single, twin, and quad arrangements, are X-Y stackable, and flush mounting is easy and convenient.

Hewlett-Packard LED lamps are available in a wide variety of plastic and hermetic packages to satisfy almost any application. Many styles can be mounted on a front panel using clips and all are suitable for P.C. board mounting. Hewlett-Packard military screened hermetic lamps are very popular in applications demanding hi-reliability.

Products with wide or narrow viewing angles, and a range of brightnesses, are available in red, high efficiency red, yellow and green. Package styles include the traditional T-1-3/4, T-1, and T0-18 packages, as well as our own subminiature [stackable on 2.54mm (0.100") centers], subminiature arrays, rectangular, and panel mountable hermetic packages.

Write for More Information

Hewlett-Packard Optoelectronic capabilities are described in data sheets and application notes and bulletins. The 1981 Optoelectronics Designer's Catalog combines the technical information available in the application notes and data sheets into one book. This catalog is free. All literature, prices, product availability and information can be obtained from any Hewlett-Packard Sales Office or authorized distributor.

Optoelectronics Applications Manual

A vastly expanded version of the original Optoelectronics Applications Manual published by McGraw-Hill in 1977, this new edition provides the electronic engineer with up-to-date design techniques on state of the art optoelectronic products. This book can be purchased from a Hewlett-Packard authorized distributor or from the McGraw-Hill Publishing Company.

Hewlett-Packard RF and Microwave components, utilized in consumer, industrial, military and other OEM equipment, assure optimum system performance. Advanced processing techniques are employed to produce highly sophisticated Silicon and Gallium Arsenide devices. The product line consists of silicon bipolar and GaAs field-effect transistors; a new family of Power MOS field-effect transistors; Schottky, PIN, Step Recovery Diodes; and Integrated Products.

Transistors

Power MOS Field Effect Transistors: HP's new Power MOS FETs are designed primarily for use in off-line switching power supplies, power inverters and converters—but are also ideal for ultrasonic transducer drivers, audio amplifiers and general industrial applications.

Called Hewlett-Packard's HPWR-6501 family, these high-performance power FETs feature high breakdown voltage (V_{DSS}): 450 V minimum; low on-resistance ($R_{(on)}$): 0.85 Ω maximum; and fast switching speed: 50 nanoseconds typical. They operate at high frequencies (200 kHz or more), with simple drive circuits and are not limited by "second breakdown" phenomena in their rated safe operating area.

These Power MOS FETs are available in the industry-standard TO-3 steel hermetic package, rated at 90 watts dc dissipation.

Chips are fabricated with planar, double-diffused ("DMOS") design. They all feature guard-ring structure for high-voltage capability, providing reliable operation in industrial applications.

Silicon Bipolar Transistors: Device-to-device uniformity and superior performance are combined in the HXTR series of microwave devices which have been individually designed for low noise (HXTR-6000 series), high gain (HXTR-2000 series), low distortion linear power (HXTR-5000 series), or oscillator performance (HXTR-4101). In addition, new low cost, big pad general purpose chips (HXTR-3001/3002) are available. With guaranteed performance specifications from 1.5 GHz to 4 GHz, these devices are well suited for high reliability space, military, and industrial applications at frequencies up to 6 GHz. Examples of products in this series of devices include the low noise HXTR-6104, which typically offers 1.4 dB NF with 14 dB associated gain at 1.5 GHz, and the HXTR-5102 linear power transistor, featuring 27.5 dBm typical P_{1dB} linear power with 7 dB associated gain at 4 GHz. All devices in this family are available in package or chip form.

In addition to the extensive line of bipolar devices described above, HP offers two new,

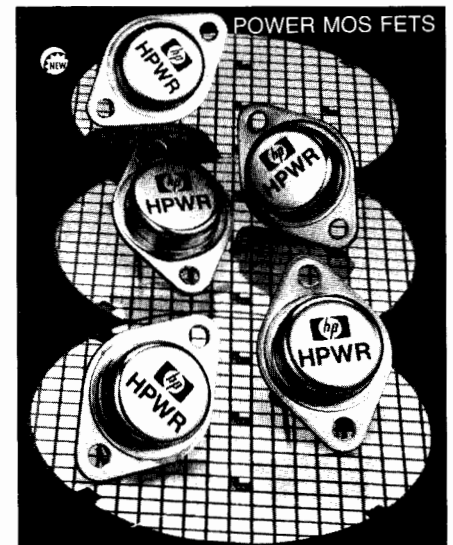
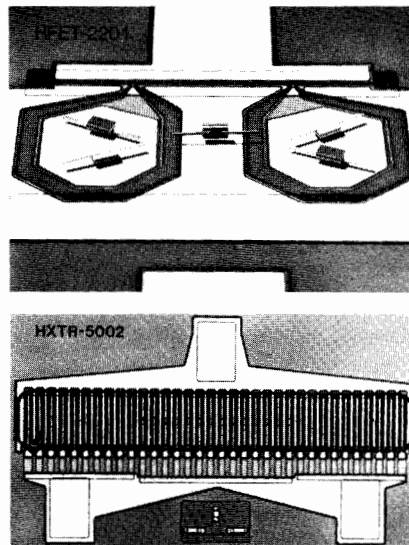
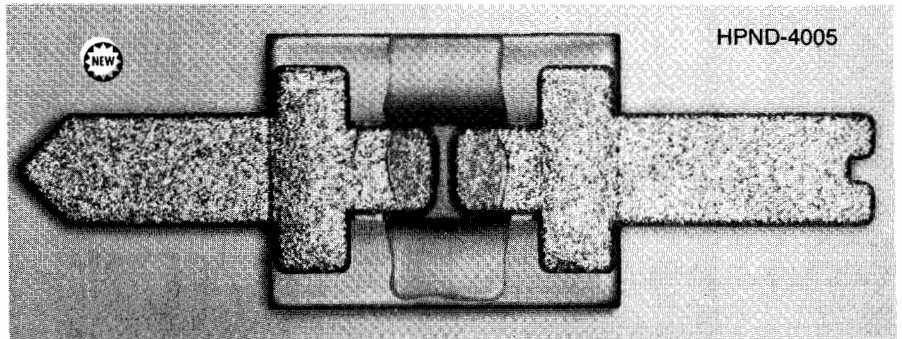

low cost NPN bipolar transistors for high gain up to 400 MHz (HXTR-3101/3102). Both are general purpose UHF silicon transistors in the HPAC-100X hermetic metal-ceramic package. They are specially designed for use in radar, ECM and communications applications. Typical performance characteristics for the HXTR-3101 includes 1.8 dB noise figure and a maximum available gain of 19.5 dB at 1 GHz. The HXTR-3102 has a 1 dB compressed gain of 11.5 dB with an output power of 21 dBm at 1 GHz.

GaAs Field Effect Transistors: HP offers a wide range of GaAs FETs to meet your application needs for low noise, high gain, and linear power from 1 GHz to 20 GHz. This family of GaAs FET's includes both chip and packaged devices for use in communications, satellite, radar and military systems. All devices are available with high reliability testing. Examples of products include the low noise HFET-2201 with 2.4 dB typical noise figure at 10 GHz; the dynamic range HFET-5001 with 100 mW typical output power at 8 GHz; and the general purpose HFET-1001

chip which is suitable for low noise, high gain or medium power application.

Hewlett-Packard silicon bipolar and GaAs field effect transistors are supplied in chip form, or in various stripline packages. Complete data sheet characterization and excellent processing uniformity make it possible to design your circuit by calculation instead of by trial-and-error.

Diodes

Schottky Barrier Diodes: Schottky diodes combine extremely high rectification efficiency with pico-second switching speeds, low series resistance, and low noise characteristics. This combination makes the Schottky an excellent mixer/detector diode.

At HF, VHF, and UHF frequencies, HP delivers glass-packaged devices in million piece quantities at economical prices. These same diodes have many digital circuit applications such as clipping and clamping where switching speed is important. The most popular of the glass packaged diodes are available in JAN qualified types.

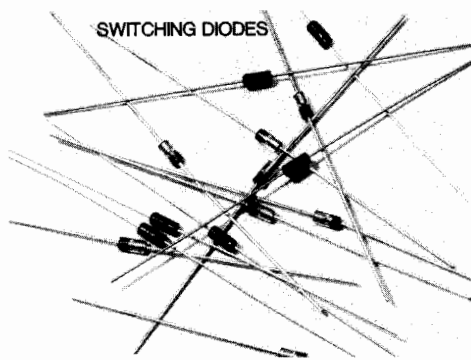
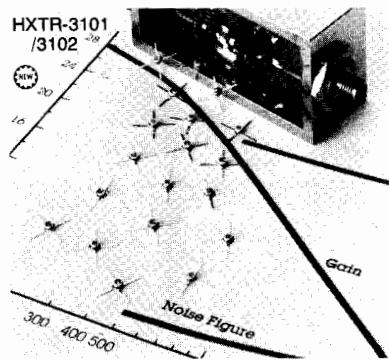

optimizing the circuit around any specific harmonic, high efficiency multiplication can be accomplished.

Diodes For Hybrid Integrated Circuits: Hybrid Integrated Circuits are used to achieve circuits with light weight, small size, operation to high frequencies, repeatable characteristics and lower end product costs. HP offers a wide range of PIN, Schottky and SRD single diodes in beam lead, chip and LID configurations as well as Schottky beam lead quad diodes.

Integrated Products

Hewlett-Packard manufactures a broad line of components for the control, conversion, and generation of RF and microwave signals. This line of integrated products (combinations of chip and beam lead diodes with hybrid thin film circuit technology) includes SPST switches, absorptive modulators, attenuators, limiters, comb generators, double-balanced mixers, and mixer/detectors.

High Reliability Testing

Many Hewlett-Packard components are space qualified. The reliability of these devices is established by one of the finest high reliability testing facilities in the microwave component industry. Hewlett-Packard's High Reliability Test Group maintains military approved JAN and JANTX parts in stock and can recommend HP standard screening programs, patterned after MIL-S-19500, for any HP component. Those who wish to design their own screening specifications can consult with and obtain quotations from Hewlett-Packard's staff of dedicated field sales engineers.

Write for More Information

Hewlett-Packard RF and microwave component capabilities are described in individual data sheets and application bulletins. All literature, prices, product availability and information can be obtained from any Hewlett-Packard Sales Office or authorized distributor.

Diode and Transistor Designer's Catalog: This catalog contains detailed, up-to-date specifications on our complete product line. It is divided into the following major sections: Silicon Bipolar Transistors, Gallium Arsenide Field Effect Transistors, Schottky Barrier and High Conductance Diodes, PIN Diodes, Step Recovery Diodes, Devices for Hybrid Integrated Circuits and High Reliability Devices.

Microwave Integrated Products Catalog: This 80 page designer's catalog contains complete specifications of our broad line of components for the control, conversion, generation and amplification of RF and microwave signals. Special testing, screening and electrical or mechanical modifications are also included.

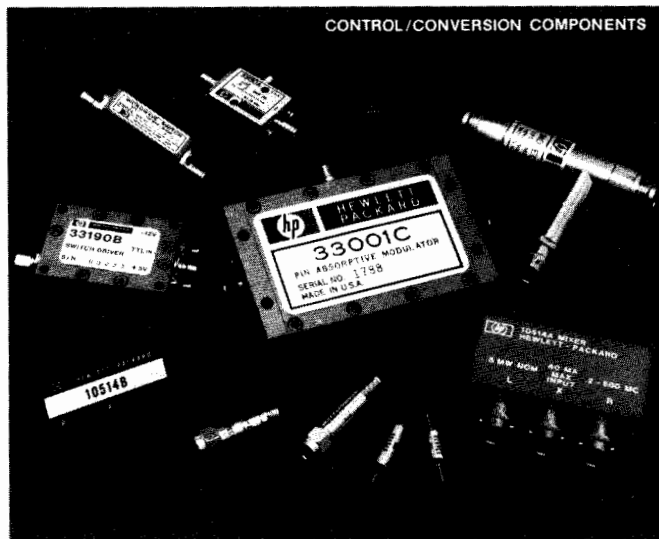
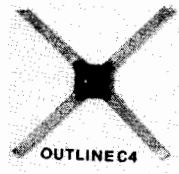
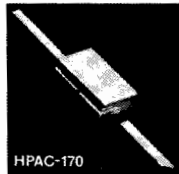
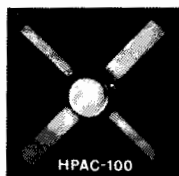

At microwave frequencies, their low noise and repeatable RF impedance lead to outstanding performance either as mixers or detectors. A series of zero bias Schottky detector diodes offers improved detection efficiency without the DC bias requirements of conventional detector diodes. Package configurations for mixer/detector diodes include beam-leaded devices as well as conventional microstrip, ceramic and axial-leaded packages.

PIN Diodes: PIN Diodes function as variable resistors at microwave frequencies. By controlling the DC bias, the RF resistance of a PIN diode can be varied from 1Ω to about $10k\Omega$. This property of the PIN diode makes it extremely useful as a switch, attenuator, modulator, phase shifter, limiter or AGC element at all frequencies, from 1 MHz to 18

GHz and above. Package configurations include conventional microstrip, ceramic and axial headed packages; as well as beam lead devices, the newest being the HPND-4005.

The HPND-4005 is specifically designed for extremely low capacitance and low series resistance. Its rugged construction includes a polyimide surface layer for scratch protection, and leads with six gram typical pull strength.

Step Recovery Diodes: SRD's are intended for use as comb generators and harmonic frequency multipliers. When used as a comb generator, the abrupt termination of the diode's reverse recovery current generates voltage pulses up to tens of volts with pulse widths as narrow as 100ps giving useful power at frequencies in excess of 20 GHz. By

ANALYTICAL INSTRUMENTS FOR CHEMISTRY

Gas Chromatographs

Whether you require the maximum in chromatographic capability and data handling or simply an instrument for precise routine analysis, Hewlett-Packard has the gas chromatograph to meet your needs.

HP5880A

The 5880A, Hewlett-Packard's most sophisticated gas chromatograph, offers expandable levels of advanced GC capability. Configurations range from a single column, single detector instrument with an isothermal oven, to a programmable oven, four-detector GC with dual integration and computation. You can augment this system with a tape cartridge unit and BASIC language programming capable of interacting with the GC. Clearly the 5880A design is completely dedicated to helping you solve your analytical problem.

Reproducibility—You can count on the 5880A to give the consistent dependable results you require. Extraordinary retention time stability is the result of new oven design coupled with sophisticated electronics and software control.

Automation—All 5880A GC's have Run time, Clock Time, and Keystroke Programming. Complete automation is achieved with the addition of automatic valves and/or an automatic sampler.

Data Handling—Peak integration, preprogrammed chromatographic calculations and BASIC programming are optional. You can store programs, instrument setpoints and other data on the tape cartridge unit and recall the information when you need it.

Communications—Options are available that allow the 5880A to output an analog detector signal for processing by an external data system or integrator. It can also accept an analog signal from another GC and process it as though it came from a 5880A detector; or output a digital signal for use by an HP 3350 Series Lab Automation System. In addition, the 5880A can communicate analysis report information to a central computer system or calculator for archival storage or further processing.

HP 5840A

The Hewlett-Packard 5840A is a complete analytical GC system which produces a comprehensive chromatogram and report including peak retention times, area, and calculated amounts. A wide range of detectors, valves, and accessories can help you get solutions to almost any GC problem. An optional capillary inlet system facilitates high resolution work. Magnetic card storage of complete analytical methods simplifies setup of routine procedures.

HP5700A

The 5700A Series gas chromatographs are low-cost, reliable answers to your analytical needs. Along with dual column and multi-detector capacity, options include specific detectors, dual input/output electrometer, electronic baseline compensation and glass capillary inlet system.

In addition, you can interface the 5700A GC's with Hewlett-Packard's popular low-

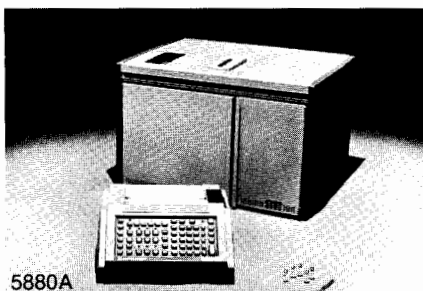

5880A

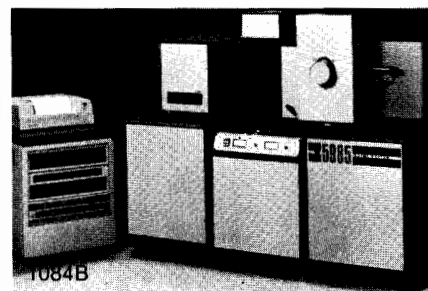

1084B



8450A

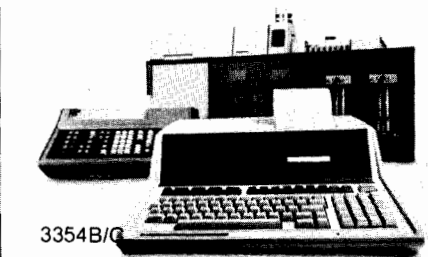

3354B/Q

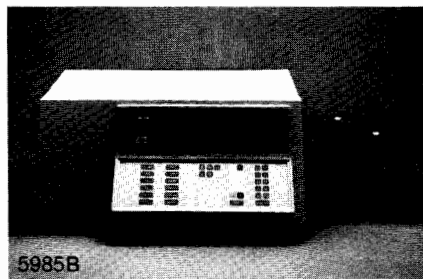

5985B



3388A

cost 3390A Reporting Integrator for an economical well-balanced chromatographic system giving you a full range of GC capabilities from routine to high resolution or trace analyses.

Laboratory Automation Systems

HP3350 Series Laboratory Automation Systems can increase your sample throughput, provide easy-to-use, yet sophisticated data reduction, perform record keeping tasks and automate your analytical procedures. Ascending levels of laboratory automation give you the freedom to configure an affordable system to meet your present needs, and grow easily and economically to meet future requirements. Software capability can grow from the turn-key chromatographic package to include automatic sampler control, simulated distillation, and LAB BASIC. Optional IMAGE/1000 software facilitates data-base creation and management. Up to 1 megaword of mainframe memory, 370 megabytes of on-line disc storage, and four 9-track magnetic tapes are available.

The state-of-the-art in automation, lab data handling, and data management, the HP 3356 Lab Automation System is designed for the analytical customer whose computational and data handling needs are extensive. Operationally, the HP 3356 is a combination of LAS software and the RTE-IVB Real Time Executive Operating System, using the SESSION MONITOR capability. The RTE users can be assigned capability levels restricting access to system commands depending on their own level of expertise, and can write programs to access

the data produced by the LAS routines.

In addition to FORTRAN Programming, the HP 3356 can handle up to 60 instrument interfaces.

UV/VIS Spectrophotometers

HP8450A

This powerful, computer-controlled UV/VIS instrument measures and displays in seconds: multiple components, a full spectrum, list of analysis conditions and concentrations.

The HP 8450A has an innovative reversed-optics design which disperses the light that has passed through a sample simultaneously across two parallel arrays of light-sensitive diode detectors—one array measuring visible, the other ultraviolet light. Resulting spectra are shown instantly on the instrument's built-in video display.

The HP8450A offers high precision, high productivity and versatility in single and multicomponent sample analyses with easy keystroke programming of operating parameters and measurement of virtually any sample with only minimum preparation.

Because of its high sensitivity, speed, and ability to monitor several component concentrations simultaneously, the 8450A is particularly well suited for kinetics work. From the keyboard, which is sealed to prevent damage from chemical spills, the spectrophotometer can be programmed to alter many operating parameters at specified times during an analysis.

Internal diagnostics shorten down time and lower service costs. Peripherals offered for the HP 8450A include plotters, printer/plotters, and a cartridge tape drive for external data storage.



Liquid Chromatographs

HP 1084B

The HP 1084B is designed to meet the exacting requirements of research and analytical method development.

Key product features keep the needs of researchers in mind. The variable volume injector handles sample sizes between 10 and 200 μ l and the 60-bottle automatic sampler uses either 2-ml vials or where only small quantities are available—microvials. Solvent flow and composition are programmable.

Refractive index, fixed (245nm) and variable (190-600nm) wavelength detectors are available. The variable wavelength detector can be programmed to change wavelengths automatically either during or between runs. The 1084B can also change separation parameters, calibration factors and calculation procedures between runs, enabling greater ease of method development.

The microprocessor controls and monitors all subsystems according to the analyst's instructions. The 1084B injects the sample at full column pressure without interrupting solvent flow, controls solvent composition, generates flow gradients, and collects, computes, and reports chromatographic data—all automatically.

The new 79885A interface provides BASIC programmability using the HP 85 Personal Computer. Random sample injection control, sophisticated post-run calculations, and automated method development are possible with this new capability.

HP 1081B

The HP 1081B is a new compact, isocratic liquid chromatograph which is simple to use and offers the precise control of parameters needed to operate efficiently for repetitive quantitative analysis.

Only six keys on the 1081B are needed to access, set, and check all the microprocessor-controlled functions, including operation of the optional 60-vial automatic sampling system.

The flow system uses a single-head diaphragm pump with closed-loop processor control. Actual and set flow rates, along with all other functions, can be monitored on a three digit numeric display. The 1081B operates efficiently with both integrator and data systems. It is the first LC to offer total two-way communications with a laboratory automation system; up to ten 1081Bs can be connected in series and controlled by a single laboratory automation system (RS232C interface).

Reporting Integrators

HP's integrators satisfy almost any ana-

lytical requirement from simple area % reporting to sophisticated data handling and automation.

HP 3388A

The HP 3388A Reporting Integrator provides the chromatographer with extensive analytical capabilities for data handling. The dual channel option allows for simultaneous operation of two instruments, each with its own printer/plotter. Standard calculation procedures include area %, external standard, normalization, and internal standard.

Other features of the 3388A include BASIC programming, alphanumeric and functional keyboards, multiple reference peaks, automatic recalibration, multiple internal standards, time-selectable area slices, and retention time labeling to 1/1000 of a minute.

HP automatic sampler control and cartridge tape unit are available as options.

HP 3390A

The compact, economical HP 3390A Reporting Integrator detects and integrates peaks with a flexibility adaptable to all forms of chromatography as well as many non-chromatographic techniques. Calculations can be made by peak area or peak height, and signal filtering systems minimize noise for enhanced reproducibility.

The HP 3390A performs all standard chromatographic calculations, calibrations, and stores up to 9 methods.

Use with the 19400A Sampler/Event Control Module provides automated control of HP automatic samplers and external devices. Also available as an option is the HP 85 Personal Computer, for report manipulation, storage, and a host of calculator functions.

GC/Mass Spectrometer Systems

All HP systems are of advanced design and include innovations such as hyperbolic quadrupole mass filters, the theoretically ideal design which provides improved peak shapes and higher sensitivity, compared to round-rod filters.

HP 5992 Series

Compact HP 5992A or B Series Systems offer excellent performance at an economical price. Features include an HP 9825B Desktop Computer Controller with HP 9876B Printer, easy-to-use software with AUTOTUNE (automatic tuning), and a wide range of accessories including the Purge/Trap Sampler unit for measuring organics in water. HP 5992B Systems include automatic, rather than manual, valving for control of effluent and calibration compound to the ion

source, plus provision for CO₂ sub-ambient cooling. Mass range to 800; 1 ng scanning sensitivity.

HP 5995A

This versatile benchtop GC/MS has all the features of the HP 5992 plus direct insertion probe, turbomolecular pump, and independent temperature control for transfer line, source, and analyzer.

It uses the same controller and printer as the HP 5992B with an expandable, flexible disc system. Software programs (including AUTOTUNE) control the gas chromatograph, scan the mass spectrometer, monitor up to six ions in the selected ion monitoring mode, plot and tabulate normalized spectra, search libraries, and perform self-diagnostics. FID and split/splitless capillary are options.

HP 5993B Series

This middle-priced system combines the compact GC/MS of the HP 5992B with a powerful data system very similar to that provided with the HP 5985B. A full line of computer accessories including 9-track magnetic tape are available. The HP 5993A Systems have manual valving; the B-Series has automatic valving. Mass range is 10 to 800 amu.

HP 5986A

The HP 5986A has dual CI/EI source and other GC/MS features of the HP 5985B. It is controlled by the HP 9825B Desktop Computer operating with the expandable, flexible disc system available on the HP 5992. Its 800 amu mass range can be increased to 1000 and a powerful data system can be added by upgrading to the HP 5985B Hardware/Software Operating System.

HP 5985B

Top-of-the-line research system provides the ideal answer for collecting, storing, and processing the vast amount of data produced from GC/MS measurements. It includes CI/EI dual source, mass range to 1000 amu, and direct insertion probe operation. The microprocessor-controlled dual column HP 5840A GC can operate independent from the MS for use as a stand alone GC with integrator, time and run programming and methods analysis. The data system in the 5985B includes 10 million words of disc storage, a program for automatic sampler control, Probability Based Library Search, and simultaneous data acquisition/reduction operation. Options include negative ion detection, LC/MS interface, and turbomolecular pumps.



Ultrasound Imaging

- Real-time phased array systems for echocardiography and radiology
- Small lightweight transducers
- Image recording combines with recording of ECG, pulse and heart sounds.

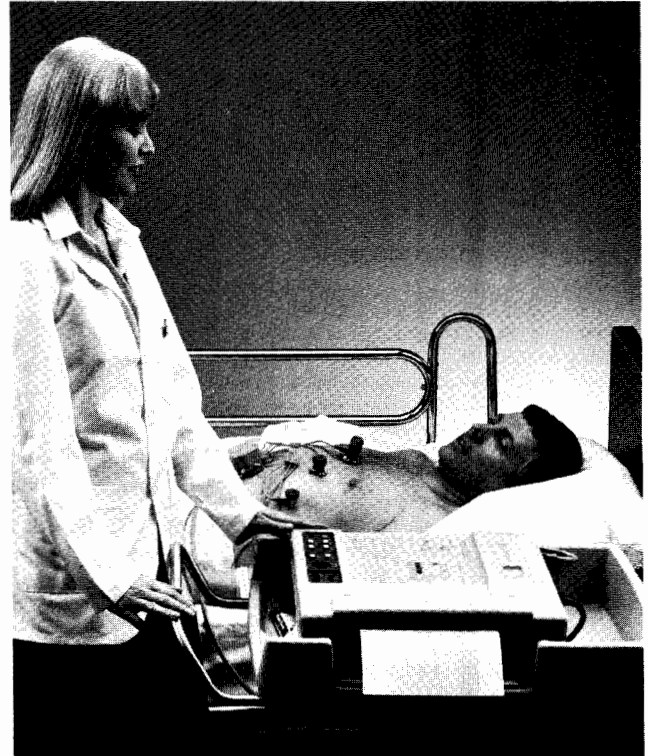

Cardiography Instrumentation

- New 4700A PageWriter Cardiograph
- ECG Management Systems for computer-aided interpretation of electrocardiograms
- ECG Stress Testing Systems.

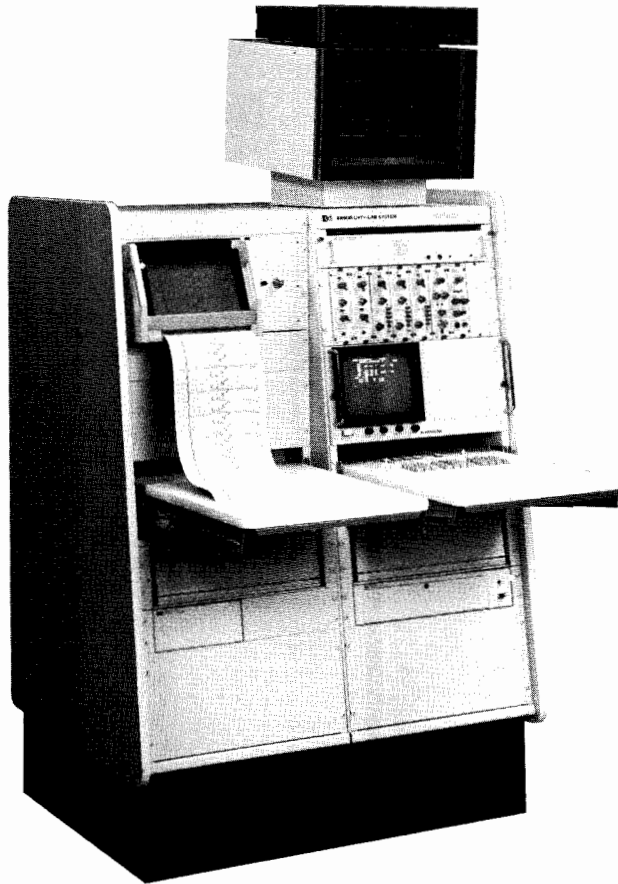

Cardiovascular Instrumentation

- Computerized catheterization data analysis system automates on-line data collection analysis
- Complete choice of plug-in signal conditioners, transducers, meter and numerical displays.



Pulmonary Instrumentation

- Pulmonary Calculator System
- Measurements for spirometry, lung volumes and distribution, diffusion
- Modular pulmonary function testing instruments
- Ear oximeter.



CO₂ Monitor (Capnometer)

- New 47210A Capnometer • For operating room and respiratory care units • Calculates and displays the partial pressure of carbon dioxide and respiration rate • Comprehensive alarms, audible and visible.



Radiology

- For pathology specimens, radiography, Model 43805P shielded cabinet X-ray system with automatic exposure control • Model 43807P for practical laboratory training of radiological technologists.

Perinatal Instrumentation

- Fetal/maternal monitoring equipment includes bedside fetal monitors and central stations • Telemetry for birthing centers • Neonatal monitoring includes heart rate, temperature, respiration, ambient oxygen.



Patient Monitoring and Resuscitation

- Stand-alone monitors • Modular instruments • ECG telemetry • Arrhythmia detection, storage and recall • Patient Data Management • Mobile resuscitation Systems • Battery/AC operating defibrillator/monitor.



For Additional Information on HP medical instrumentation, request from following brochures, data sheets, and catalogs:

- Patient Monitoring #5953-1391 • Resuscitation #5953-1201
- Perinatal #5953-4877 (fetal monitoring), #5953-4823 (telemetry)
- Cardiology #5953-4937 (PageWriter), #5953-4915 (ECG Management Systems) • Ultrasound Imaging #5953-4936 (Radiology), #5953-4932 (Cardiology) • Pulmonary #5952-5257
- Capnometer #5953-1344 • Radiology #5952-6839 and 5952-6843 • Medical Instrumentation Supplies Catalogs: #5953-4802 Critical Care Supplies, #5953-4801 Cardiology Supplies, 5953-4800 Labor and Delivery Supplies, #5953-4803 Multi-Channel Recording Supplies, #5953-4804 Pulmonary Diagnostic Supplies.

APPLICATIONS INFORMATION

Designed To Help You Obtain Maximum Use From Your HP Equipment

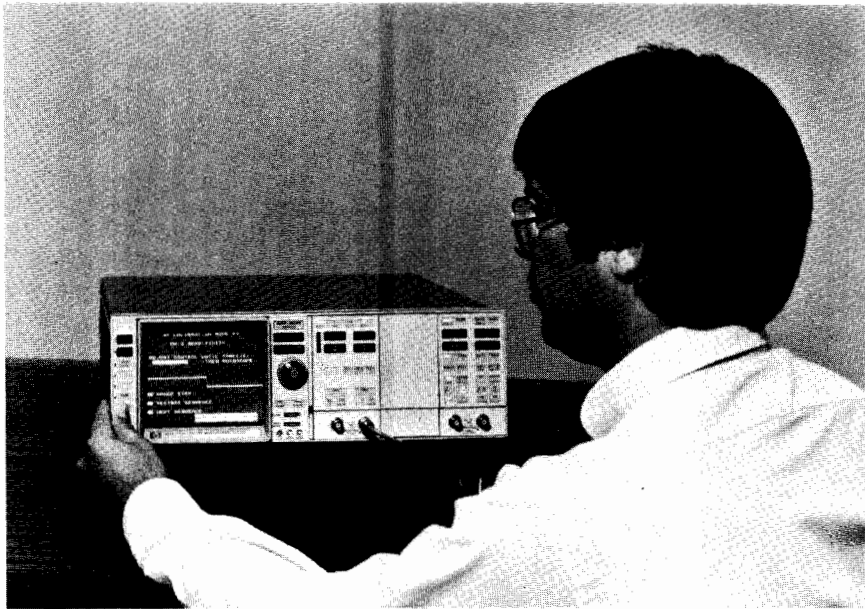

Hewlett-Packard Application Notes are a compilation of applications research and experience which have been written in collaboration with HP engineers and our customers. Some are tutorial, while others describe specific "how to" procedures. Listed below are the application notes that are currently available from your local sales office. Or, you may write directly to Application Notes, Hewlett-Packard, 3000 Hanover St., Palo Alto, California 94303, U.S.A.

- | | | | |
|---------|--|--------|---|
| 52-1 | Fundamentals of Time and Frequency Standards | 124 | True RMS Measurements |
| 52-2 | Timekeeping and Frequency Calibration | 140-6 | Measurement of Machine Tool Vibration |
| 57 | Noise Figure Primer | 140-7 | Nuclear Power Plant Diagnostics Using Fourier Analysis Techniques |
| 63E | Modern EMI Measurement | 142 | EMI Measurement Procedure |
| 63E-1 | Quasi-Peak Measurements Using a Spectrum Analyzer | 150 | Spectrum Analysis... Spectrum Analyzer Basics |
| 64-1 | Fundamentals of RF and Microwave Power Measurement | 150-1 | Spectrum Analysis... AM and FM |
| 64-2 | Extended Applications of Automatic Power Meters. | 150-2 | Spectrum Analysis... Pulsed RF |
| 64-3 | Accurate and Automatic Noise Figure Measurements | 150-3 | Spectrum Analysis... Tracking Generators |
| 77-1 | Transistor Parameter Measurements | 150-4 | Spectrum Analysis... Noise Measurements |
| 77-3 | Complex Impedance Measurements | 150-7 | Spectrum Analysis... Signal Enhancement |
| 77-4 | Swept-Frequency Group Delay Measurements | 150-8 | Spectrum Analysis... Accuracy Improvement |
| 89 | Magnetic Tape Recording Handbook | 150-9 | Spectrum Analysis... Noise Figure Measurement |
| 90B | DC Power Supply Handbook | 150-10 | Spectrum Analysis... Field Strength |
| 91 | How Vector Measurements Expand Design Capabilities—1 to 1,000 MHz | 150-11 | Spectrum Analysis... Distortion Measurements |
| 95-1 | S-Parameter Techniques for Faster, More Accurate Network Design | 150-12 | Spectrum Analysis... Using the HP 11517A External Mixer to 40 GHz |
| 115 | Principles of Cathode-Ray Tubes, Phosphors, and High-Speed Oscillography | 150-13 | Stimulus-Response Measurements Using the HP 8565A |
| 123 | Floating Measurements and Guarding | | |
| | | | Spectrum Analyzer from 2 to 18 GHz |
| 150-14 | | | Spectrum Analysis Using External Waveguide Mixers Above 40 GHz |
| 152 | | | Probing in Perspective |
| 154 | | | S-Parameter Design |
| 155-1 | | | Active Device Measurements with the HP 8755 Frequency Response Test Set |
| 155-2 | | | 100 dB Dynamic Range Measurements Using the HP 8577 Frequency Response Test Set |
| 156-2 | | | Calibration of a Surface Plate |
| 156-4 | | | Calibration of a Machine Tool |
| 156-5 | | | Measurement of Straightness of Travel |
| 162-1 | | | Time Interval Averaging |
| 163-2 | | | New Techniques of Digital Troubleshooting |
| 164-2 | | | Calculator Control of the 8660A/C Synthesized Signal Generator |
| 164-3 | | | New Techniques for Analyzing Phase Lock Loops |
| 164-4 | | | Digital Phase Modulation (PSK) and Wideband FM |
| 166 | | | Large Screen Display Applications and Interfacing |
| 166-2 | | | 1304A Large Screen Display Applications and Interfacing |
| 167-4 | | | Engineering in the Data Domain Calls for a New King of Digital Instrument |
| 167-5 | | | Troubleshooting in the Data Domain is Simplified by Logic Analyzers |
| 167-6 | | | Mapping, a Dynamic Display of Digital System Operation |
| 167-7 | | | Supplementary Data From Map Displays Without Changing Probes |
| 167-9 | | | Functional Analysis of the Motorola M6800 Microprocessor System |
| 167-11 | | | Functional Analysis of INTEL 8008 Microprocessor System |
| 167-12 | | | Functional Analysis: Fairchild F8 Microprocessor Systems |
| 167-12A | | | Functional Analysis: MOSTEK F8 Microprocessor Systems |
| 167-14 | | | Functional Analysis of 8080 Microprocessor Systems |
| 167-15 | | | Functional Analysis of INTEL 4004 Microprocessor Systems |
| 167-16 | | | Functional Analysis of INTEL 4040 Microprocessor Systems |
| 167-17 | | | Functional Analysis of National IMP Microprocessor Systems |
| 167-18 | | | Functional Analysis of National Semiconductor SC/MP Microprocessor System |
| 167-19 | | | Systematic "Turn-On" of Microprocessor Systems Using Logic State Analyzers |

- 170-1 HP 8640A/B Signal Generator Output Level Accuracy
- 170-2 The 8640A/B Third Order Intermodulation Product Characteristics
- 171-1 Crystal Testing with the 8640A/B and 8405
- 171-2 Extending the 8640B Frequency Down to DC
- 173 Recent Advances in Pulsed RF And Microwave Frequency Measurements
- 174-0 Index to the AN-174 Application Note Series
- 174-1 Measuring the Transfer Characteristic of a Voltage Controlled Oscillator
- 174-2 Measuring Differential Nonlinearity of a Voltage Controlled Oscillator
- 174-3 Measuring Integral Nonlinearity of a Voltage Controlled Oscillator
- 174-4 Measuring Dual VCO Tracking Error
- 174-5 Determining Probability Densities (Histograms) with the 5345A Electronic Counter
- 174-6 Measuring the Stability of a Frequency Source
- 174-7 Measuring Fractional Frequency Standard Deviation (SIGMA) Versus Averaging Time (TAU)
- 174-8 Measuring FM Peak-to-Peak Deviation
- 174-9 Making Automatic Phase Measurements with the 5345A Electronic Counter
- 174-10 Measuring Electrical Length Delay of Cables
- 174-11 Measuring Warm-Up Characteristics and Aging Rates of Oscillators
- 174-12 Measuring Frequency Sweep Linearity of Sweep Generators
- 174-13 Measuring the Tuning Step Transient Response of VCO's To 18 GHz
- 175-1 Differential Phase and Gain At Work



- 176-5 A Comparison of Magnetic Sector and Dodecapole Spectra
- 176-8 Explosives: Analysis Using Dual Chemical/Electron Ionization GC/MS
- 176-10 Methane: Its Usefulness as Both Carrier and Reactant Gas in Chemical Ionization GC/MS
- 176-11 Femtomole Analysis of a Biogenic Amine by GC/MS
- 176-12 Picogram Detection of Tetrachlorodibenzodioxin
- 176-13 Reactant Gas Selection in Chemical Ionization Mass Spectrometry Part I (See 176-18)
- 176-18 Reactant Gas Selection in Chemical Ionization Mass Spectrometry: Part II. (See 176-13)
- 176-19 Use of a Mixed Reagent Gas for Chemical Ionization GC/MS
- 176-21 Automatic Data Reduction and Analysis Using Batch Processor GC/MS
- 176-22 Analysis of Chloropesticides And PCB's in Cheese by Glass Capillary GC/MS Using the Selected Ion Monitoring Technique
- 176-23 Capillary Column GC/MS Analysis of Essential Oils
- 176-24 GC/MS Analysis of Volatile Organic in Water
- 176-25 Ensuring Reproducible Mass Spectral Patterns with Automatically Tuned GC/MS Systems
- 176-26 Identification of Drugs in Body Fluids Using GC/MS
- 176-27 Precision, Accuracy and Sensitivity Determination of SIM Analysis Using an Automated GC/MS Injection and Data Reduction System, BATCH SIM
- 176-28 Probability Based Search System (PBS)
- 176-29 LC/MS Analysis of Bromocryptine
- 176-30 Quantitation of Dalmane by NCI
- 176-31 Optimization of Direct Insertion Probe Mass Spectral Sampling Techniques for Labile Drugs (5952-5841)
- 176-32 Drug Analysis and the Utility of GC/MS for Detecting Impurities in Gas Chromatographic Peaks (5952-5842)
- 176-33 The Application of GC/MS in Equine Drug Testing (5952-5843)
- 176-34 Sensitivity: Its Definition and Measurement in Digital GC/MS Systems (5952-5844)
- 176-35 LC/MS of Antibiotics: Spectinomycin and Erythromycin (5952-5845)
- 176-36 Characterization of Dihydrodiols of Polycyclic Aromatic Hydrocarbons (5952-5846)



- 176-37 Investigations of Biochemical Diseases (5952-5847)
- 176-38 Quantitative Analysis of Urinary Prostaglandins by Glass Capillary GC/MS (5952-5848)
- 181-1 Measuring Linearity of VCO's From 10Hz to 23 GHz
- 181-2 Data Acquisition with the 5300B Measuring System
- 183 High Frequency Swept Measurements
- 185 Waveform Parameter Measurements Using the Microprocessor Controlled Oscilloscope (1722)
- 185-2 Transmission Line Matching And Length Measurements Using Dual-Delayed Sweep
- 185-3 Percent Amplitude Modulation Measurements in the Time Domain
- 185-4 Elimination of Computation of Analog Measurements by Using the Direct Reading Oscilloscope 1722
- 187-2 Configuration of a 2-18 GHz Synthesized Frequency Source Using the 8620C Sweep Oscillator
- 187-4 Configuration of a Two-Tone Sweeping Generator
- 187-5 Calculator Control of the 8620C Sweep Oscillator Using the HP-1B
- 187-6 The Frequency Performance of the 8620C Sweep Oscillator Under Remote Programming
- 188 Thermocouple Measurements with the 3050B
- 191-1 Automatic Zero Calibration of the 5359A Time Synthesizer at a Designated Remote Location
- 191-2 Determining Digital Circuit Timing Tolerance to Optimize Adjustment or Design
- 191-3 Precision Time Interval Measurements in Radar Applications

APPLICATIONS INFORMATION

Designed To Help You Obtain Maximum Use From Your HP Equipment



- | | | | | | |
|-------|---|--------|--|--------|--|
| 191-4 | Using the 5370A Universal Time Interval Counter to Characterize Pulse Width, Repetition Rate and Jitter | 201-8 | HP 1000/HP-1B: the Use of Device Subroutines with HP 1000 Computers | 214-3 | X-Y Recorder Input Connection Configuration and Input Noise |
| 191-5 | Measurement of Propagation Delays Using the 5370A Time Interval Counter and 5363B Time Interval Probes | 201-10 | Communication Between 9835/9845 Desktops and HP 1000 Computer | 214-4 | High Sensitivity X-Y Recorder Has Few Restrictions |
| 191-6 | Precise Cable Length and Matching Measurements Using the 5370A Universal Time Interval Counter and 5363B Time Interval Probes | 202-1 | Optical Mark Readers Substantially Increase Productivity | 215-1 | A More Rugged, Cleaner Writing Oscillographic Ink Recorder |
| 192 | Using a Narrow Band Analyzer for Characterizing Audio Products | 202-3 | Distributed HP Optical Mark Readers Provide Easy Remote Data Collection | 216 | A Guide to the Use of the HP 3570A/3571A Analyzers |
| 195 | Pulse Generator Techniques in CMOS Applications | 204-1 | Automatic Accelerometer Calibration | 218-1 | Applications and Performance of the 8671A/8672A Microwave Synthesizers |
| 196 | Automatic Measurements Using HP 436A Power Meter | 204-2 | Energy Conservation in a Restaurant | 218-2 | Obtaining Millihertz Resolution from the 8671A and 8672A |
| 196-1 | Automated Measurements Using the 432C Power Meter | 205-1 | Low Frequency Amplitude Considerations of the 3042A System | 218-3 | A 1 MHz-18 GHz Signal Generator with 1, 2, or 3 Hz Resolution |
| 197-1 | Laser Interferometers for Position Feedback | 205-2 | Sonar Transducer Calibration Measurement and Computation with the HP 3042A Automatic Network Analyzer System | 218-4 | Synthesized Signals From 18 to 37.2 GHz Using the 8672A |
| 197-2 | Laser and Optics of HP 5501A Laser Transducer | 206-1 | Measuring Wide-Band Noise with the HP-3045A Automatic Spectrum Analyzer | 221A | Automating the HP 8410B Microwave Network Analyzer |
| 198 | Event-Related Triggering... A Clear Solution for Digital Signals | 207 | Understanding and Using Phase Noise in the Frequency Domain | 222 | A Designer's Guide to Signature Analysis |
| 200 | New Fundamentals of the Electronic Counters | 210-1 | Modeling and Simulation for Digital Testing | 222-0 | An Index to Signature Analysis Publications |
| 200-1 | Fundamentals of Microwave Frequency Counters | 210-4 | Designing Digital Circuits for Testability (DTS-70) | 222-1 | Implementing Signature Analysis for Production Testing with the 3060A Board Test System |
| 200-2 | Fundamentals of Quartz Oscillators | 213-1 | Dropouts (Loss of Signal in Tape Recording) | 222-2 | Application Articles on Signature Analysis |
| 200-3 | Time Interval Measurement Using an Electronic Counter | 213-2 | Crosstalk (Tape Recording) | 222-3 | A Manager's Guide to Signature Analysis |
| 200-4 | Understanding Frequency Counter Specifications | 213-3 | Interchannel Time Displacement Error. (Tape Recording) | 222-4 | Guidelines for Signature Analysis: Understanding the Signature Measurement |
| 201-6 | Computer Interconnections: a Choice of Ways to Link HP 1000 System to HP 9825AS Desktop | 214-1 | Recording with Input Noise Present | 222-10 | A Signature Analysis Case Study of a Z80-Based Personal Computer |
| | | 214-2 | X-Y Recorder Dynamic Response | 224-2 | Signal Conditioning: HP 22914A Breadboard Card |
| | | | | 225 | Measuring Phase Spectral Density of Synthesized Signal Sources Exhibiting f^0 and f^{-1} Noise Characteristics with the 5390A Frequency Stability Analyzer |
| | | | | 225-1 | Measurement Considerations When Using the 5390A Option 010 |
| | | | | 227 | Word Generator Techniques in Multi-Channel Applications |
| | | | | 228-3 | Determination of Benzene and Toluene in Gasoline |
| | | | | 228-4 | Applications and Operation of the Nitrogen-Phosphorus Detector |
| | | | | 228-5 | Optimizing Analysis Using Splitless Injection on Capillary Columns |
| | | | | 228-6 | Automated Determination of Benzene Adsorbed on Charcoal Tubes |
| | | | | 228-7 | Determination of Boiling Range of Petroleum Fractions |
| | | | | 228-8 | Analysis of Volatile Halogenated Organics in Water by Direct Aqueous Injection with Electron Capture Detector |
| | | | | 228-10 | Hydrocarbon Group Type Analysis of Gasoline by High Performance Liquid Chromatography |

- 228-13** A Technique for the Reduction of Foaming in Purge and Trap Samples
- 228-14** Precision of the HP 5880 Chromatographic System Achieved for a Complex Sample
- 229-1** HP-Plot/2I Software Conversion Guide
- 230-1** Automated Data Reduction for Gel Permeation Chromatography
- 230-2** Using a Laboratory Automation System to Facilitate Industrial Hygiene Monitoring
- 230-3** Plotting Chromatograms with the 18675B Four-Pen Plotter
- 230-4** The Parameters of GPC-Automated Molecular Weight Distribution by the 3354 Lab Automation System
- 230-5** Correlated ASTM Distillation Distribution Based on Simulated Distillation (ASTM D-2887) Data
- 232-1** HPLC of Pharmaceutical Products Analgesic Tablets
- 232-2** HPLC Method Development on the HP 1084A
- 232-3** Theophylline Assay by High Performance Liquid Chromatography
- 232-4** HPLC Analysis of Food Additives I: Preservatives
- 232-5** HPLC Analysis of Food Additives II: Antioxidants
- 232-6** HPLC of Pharmaceutical Products: Vitamins
- 232-9** Hydrocarbon Group Type Analysis of Gasoline by High Performance Liquid Chromatography
- 232-10** Molecular Weight Determinations by Gel Permeation Chromatography
- 232-11** Reproducibility of the Model 1081B Liquid Chromatograph for Gel Permeation Chromatography
- 232-13** Analysis of Some Lipids in Biological Material
- 232-14** Analysis of Carbohydrates in Food by HPLC
- 232-15** Crude Oil Characterization Using Gel Permeation Chromatography
- 232-16** Errors in Average Molecular Weights in Gel Permeation Chromatography Due to Improper Baseline Correction
- 232-17** Analysis of Fatty Acid Derivatives by HPLC
- 233-1** Functional Analysis of Signetics 2650 Microprocessor Systems Using the 1610A
- 233-2** Functional Analysis of TMS 9900 Microprocessor Systems Using the 1610A
- 233-3** Functional Analysis of ZILOG Z80 Microprocessor Systems Using the 1610A
- 233-4** Functional Analysis of 8080 Microprocessor Systems Using the 1610A
- 233-5** Functional Analysis of Motorola M6800 Microprocessors Systems Using the 1610A
- 233-6** Functional Analysis of HP 1000 L-Series Computer Using the 1610A/B
- 233-7** Computer Performance Analysis Using the 1610 A/B
- 233-8** Functional Analysis of 8085 Microprocessor System Using the 1610B
- 235** An Introduction to Balanced Circuits and Impedance Matching
- 236-1** A "Make" or "Buy" Analysis for Power Supplies
- 236-2** Two Power Supply Redundancy Schemes
- 236-3** Measure Switcher Efficiency without a Wattmeter
- 238** Measurement of Semiconductor Characteristics with the HP 4140A pA Meter/DC Voltage Source
- 240-1** Feedback Control System Measurements
- 245-1** Signal Averaging with the HP 3582A Spectrum Analyzer
- 245-2** Measuring the Coherence Function with the HP 3582A Spectrum Analyzer
- 245-3** Third Octave Analysis with the HP 3582A Spectrum Analyzer
- 246** Using the HP 3585A Spectrum Analyzer with the HP 9825A Computing Controller
- 246-1** Optimizing the Dynamic Range of HP 3585A Spectrum Analyzer
- 250-1** HP-IB Power Supply Interface Guide
- 250-2** Battery Charging/Discharging
- 260-1** Understanding Hewlett-Packard's Model 1615A Logic Analyzer
- 262** Eliminating Time Base Errors From Oscilloscope Measurements
- 263** Thermal Measurements of Electronic Components Using the HP Temperature Probe
- 270-1** An Example of Automatic Measurement of Conducted EMI with the HP 8568A Spectrum Analyzer
- 270-2** Automated Noise Sideband Measurements Using the HP 8568A Spectrum Analyzer
- 271-1** Adding Soft Copy Graphics to 9825A-based Systems Using the Model 1350A Graphics Translator
- 272** Precise Time Interval Measurements Using the Crystal Controlled Time Base Model 1743A Oscilloscope
- 275** Symptomatic Troubleshooting of Computer Networks with HP 1640A
- 275-1** Using the HP 1640A Serial Data Analyzer with the EPI-COM, Inc. Model 200 CS047 Eptape Recorder
- 275-2** Using the HP 1640A Serial Data Analyzer with the Spectron Corp. T-511 Recorder
- 280-1** Making Complex Measurements with the HP Model 1602A Logic State Analyzer
- 280-2** Monitoring the IEEE-488 Bus with the 1602A Logic State Analyzer
- 280-3** The 1602A Logic State Analyzer as an Automatic Test Instrument
- 280-4** Making Measurements on Wide Buses with HP's Model 1602A Logic State Analyzers
- 281-1** Microprogramming—A Way to Get Higher Performance From HP 1000 Computers
- 282-1** 6940B Multiprogrammer System Throughput Analysis
- 283-1** HP 8662A RF Synthesized Signal Generator Performance, Familiarization and Applications
- 283-2** External Frequency Doubling of the 8662A Synthesized Signal Generator
- 284** Guide to Quartz Thermometry Measurement Accuracy
- 285** Successful Buried Cable Fault Locating
- 286-1** Applications and Operations of the 8901A Modulation Analyzer
- 286-2** Accurate Mixer/Amplifier Compression Measurement Using the 8901A Modulation Analyzer
- 287-1** Waveform Analysis Using the 5328A Universal Frequency Counter
- 287-2** Frequency Profile Using an HP 5345A Electronic Frequency Counter and an HP 5359A Time Synthesizer
- 287-3** Frequency Profile Using an HP 5370A Universal Time Interval Counter and an HP 5359A Time Synthesizer
- 289** A Stimulus for Automatic Test Thermocouple Measurement With the HP 3467A



APPLICATIONS INFORMATION

Designed To Help You Obtain Maximum Use From Your HP Equipment



- | | | |
|---|---|--|
| <p>291-1 User's Guide to the 5355/56 Automatic Frequency Converter Minicomputer Analysis Techniques Using Logic Analyzers</p> <p>292 Functional Analysis of IEEE-488 Interface Bus</p> <p>292-1 Functional Analysis of Microprocessor Systems with the 1611A - Opt. 001 General Purpose Module</p> <p>293 Semi-automatic Network Analyzer System for 4-1300 MHz Measurements</p> <p>294 Transmission Filter Measurement with the HP 8450 UV/VIS Spectrophotometer</p> <p>295-1 The Use of the HP 8450A UV/VIS Spectrophotometer in Semiconductor Manufacturing</p> <p>295-2 Quantitation of Constituents in the Presence of Scattering and Fluorescence</p> <p>295-3 Compound Identification Using the HP 8450A with Compounds Displaying Extreme Spectral Similarity</p> <p>295-4 The HP 8450A Spectrophotometer as a Liquid Chromatograph Detector</p> <p>295-5 Single Component Analysis with the HP 8450A UV/VIS Spectrophotometer</p> <p>295-6 Dissolution Testing with the HP 8450A UV/VIS Spectrophotometer</p> <p>295-7 Use of the HP 8450A UV/VIS Spectrophotometer in Semiconductor Manufacturing (II): Quality Control of Photoplate Properties</p> <p>295-8 Use of the HP 8450A UV/VIS Spectrophotometer in Semiconductor Manufacturing (III): Thin Film Thickness Measurement</p> | <p>295-11 Use of an Automatic Sampler with the HP 8450A UV/VIS Spectrophotometer</p> <p>296 Data Pattern Stimulus for Manual and Automatic Bench Use</p> <p>296-1 8170A Guide Supplement, Multichannel Serial Data</p> <p>298-1 Emulation of Microprocessor-based Systems with HP 64000 Logic Development System</p> <p>298-2 Software Project Management With HP 64000 Logic Development System</p> <p>298-3 Enhancing 64000 System Assemblers with HP 64851A User-Definable Assembler</p> <p>298-4 HP 64000 Logic Development System Microassemblers for Bit-Slice Processors</p> <p>298-5 Using the HP 64000 Logic Development System with Computer Networks</p> <p>299 Interfacing HP Model 1336S Display to High Resolution Imaging Systems</p> <p>300 High Performance, Semi-Automatic Transceiver Testing</p> <p>301-1 Low Noise Division of 10 MHz Oscillators</p> <p>302-1 Direct Radio Frequency Impedance Measurements Using the 4191A RF Impedance Analyzer Using Ultrasonic Detection to Find Pressure Leaks and Analyze Vibrations</p> <p>303 Surveying with the HP Survey System One—Geophysical</p> <p>304 Measuring with the HP 3810A Total Station—Radial Stakeout</p> <p>305 Measuring with the HP 3810A Total Station—Detail and Location Surveying</p> <p>306 Measuring with the Hewlett-Packard Total Stations—Hydrographic Surveying</p> <p>307</p> | <p>308-1 Dynamic Digital Board Test with the HP Model 3060A Option 100</p> <p>309-1 Digital Board Test on the HP Model 3060A—Static Testing Techniques</p> <p>400-1 Factory Data Collection: a Quality Assurance Early Warning System</p> <p>400-2 Factory Data Collection: an Example of How to Implement an HP 1000-Based Labor and Job Status Reporting System</p> <p>401-1 HP 1000/HP-IB Programming Procedures</p> <p>401-1L HP 1000L-Series/HP-IB Programming Procedure</p> <p>401-2 59307 VHF Switch/HP 1000 Computer: Programming Guide</p> <p>401-3 5345A Counter/HP 1000 Computer: Programming Guide</p> <p>401-4 5342A Microwave Counter/HP 1000 Computer: Programming Guide</p> <p>401-5 5328A Counter/HP 1000 Computer: Programming Guide</p> <p>401-6 3438A Digital Multimeter/HP 1000 Computer: Programming Guide</p> <p>401-7 3455A Digital Multimeter/HP 1000 Computer: Programming Guide</p> <p>401-8 59309A Digital Clock/HP 1000 Computer: Programming Guide</p> <p>401-9 6002A Power Supply/HP 1000 Computer: Programming Guide</p> <p>401-10 3437A Digital Voltmeter/HP 1000 Computer: Programming Guide</p> <p>401-11 3495A Scanner/HP 1000 Computer: Programming Guide</p> <p>401-12 3582A Spectrum Analyzer/HP 1000 Computer: Programming Guide</p> <p>401-13 3325A Function Generator/HP 1000 Computer: Programming Guide</p> <p>401-14 4262A Digital LCR Meter/HP 1000 Computer: Programming Guide</p> <p>401-15 8672A Synthesized Signal Generator/HP 1000 Computer: Programming Guide</p> <p>401-16 436A Microwave Power Meter/HP 1000 Computer: Programming Guide</p> <p>401-17 8620A Sweep Oscillator/HP 1000 Computer: Programming Guide</p> <p>401-18 59306A Relay Actuator/HP 1000 Computer: Programming Guide</p> <p>401-19 8660C Synthesized Signal Generator</p> <p>401-20 9871A Character Impact Printer</p> <p>401-21 6942A Multiprogrammer II</p> <p>401-22 HP 3497A Data Acquisition Control Unit/HP 1000 Computer</p> |
|---|---|--|

401-23 HP 2240 Measurements and Control Processor/1000 Computer

402-1 HP 1000 Application Briefs

403 HP 2608 Medium Speed Dot Matrix Printer Special Forms Printing Guide

404-3 Using the 25 kHz Power from the HP1000 L-Series Power Module to Meet Unique Power Supply Needs

405 Use of the IPS-7000 Printer with HP Data Capture Terminals

406 HP 3000/Data Capture Terminals—Programming Application Brief

407-1 Data Capture Applications—the Food Industry (1)

407-2 Data Capture Applications—the Aerospace Industry (1)

407-3 Data Capture Applications—the Electronics Industry (1)

407-4 Data Capture Applications—the Semiconductor Industry (1)

407-5 Data Capture Applications—the Packaging Industry (1)

408 Increasing System Availability Through Redundant Components

712 8800 Medical Systems—Heart Sound Measurement

718 Patient Safety

721 ECG Application Note for Nurses

725-1 Esophageal Motility

732 Recording Phonocardiography And External Pulse Wave Recording

733 Physicians Guide to the HP Cath Lab Computer System

739 Guide to Physiological Pressure Monitoring

742 A Compendium on Automated Arrhythmia Detection

743 Electrosurgery Interference—Minimize its Effects On ECG Monitors

744 Fluid Column ECG Electrodes

746 Proper Cleaning of HP Cables

747 Defibrillator Energy Dosage

748 Monitoring Instrumentation: Isolated Inputs, Electrosurgery Filtering, Burns Protection

749 X-Ray Film and Intensifying Screen Combinations

750 X-Ray Film Processing and Troubleshooting

751 Performance Verification

752 Demonstration and Installation Log—Model 43820A

753 Resuscitation Cart Planning Guide

755 Resuscitation Basics

759 A Technician's Guide to Stress Testing

760 HIS Bundle and Epicardial Electrograms—Clinical Applications

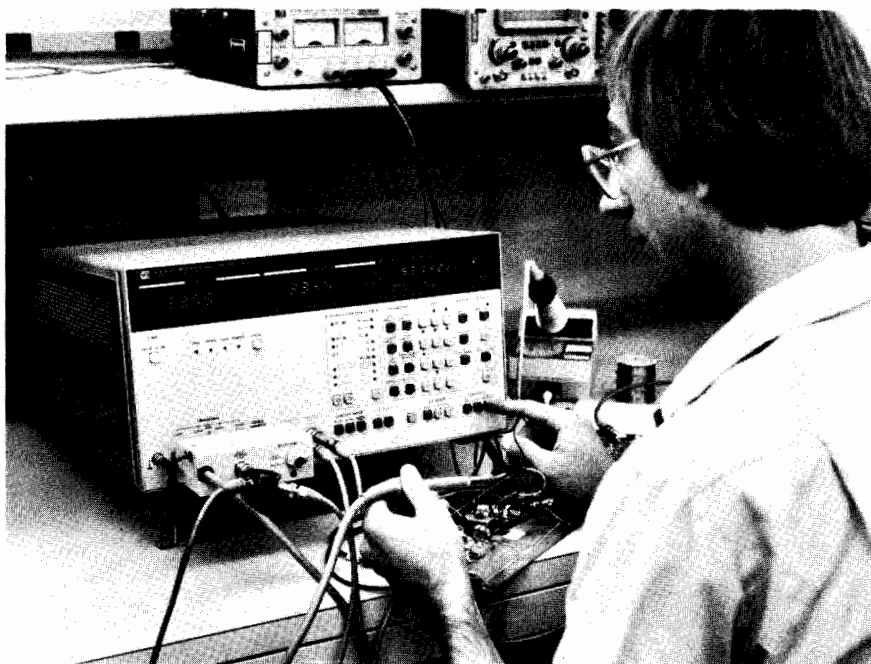

762 A Guide to Hemodynamic Monitoring Using the Swan Ganz® Catheter

763 Basic Concepts of Cardiovascular Physiology

764 Technician's Guide to Electrocardiography, 3rd Edition

765 Clinical Concepts of Fetal Heart Rate Monitoring

915 Threshold Detection of Visible And Infrared Radiation with Pin Photodiodes

922 Application of PIN Diodes

923 Hot Carrier Diode Video Detectors

928 Ku-Band Step Recovery Multipliers

929 Fast-Switching PIN Diodes

931 Solid State Alphanumeric Display Decoder/Driver Circuitry Selection and Use of Microwave Diode Switches and Limiters

934 5082-7300 Series Solid-State Display Installation Techniques

936 High Performance PIN Attenuator for Low-Cost AGC Applications

937 Monolithic Seven Segment LED Display Installation Techniques

939 High Speed Optically Coupled Isolators

942 Schottky Diodes for High Volume Low Cost Applications

944-1 Microwave Transistor Bias Considerations

945 Photometry of Red LEDs

946 5082-7030 Series Monolithic Seven-Segment Displays

947 Digital Data Transmission Using Optically Coupled Isolators

948 Performance of the 5082-4350/51/60 Isolators in Short to Moderate Length Digital Data Transmission Systems

951-1 Applications for Low Input Current, High Gain Optically Coupled Isolators

951-2 Linear Applications of Optically Coupled Isolators

956-1 The Criterion for the Tangential Sensitivity Measurement

956-3 Flicker Noise in Schottky Diodes

956-4 Schottky Diode Voltage Doubler

956-5 Dynamic Range Extension of Schottky Detectors

956-6 Temperature Dependence of Schottky Detector Voltage Sensitivity

957-1 Broadbanding the Shunt Pin Diode SPDT Switch

957-2 Reducing the Insertion Loss of a Shunt Pin Diode

957-3 Rectification Effects in Pin Attenuators

963 Impedance Matching Techniques for Mixers and Detectors

964 Contrast Enhancement Techniques

966 Applications of the HP HDSP-2000 Alphanumeric Display

967 A Low Noise 4 GHz Amplifier Using the HXTR-6101 Silicon Bipolar Transistor

969 An Optimum Zero Bias Schottky Detector Diode

970 A 6 GHz Amplifier Using the HFET-1101 GaAs FET

971 The Beam Lead Mesa Pin in Shunt Applications

APPLICATIONS INFORMATION

Designed To Help You Obtain Maximum Use From Your HP Equipment



- 972 Two Telecommunications Power Amplifiers for 2 and 4 GHz Using the HXTR 5102 Silicon Bipolar Power Transistor
- 973 12 GHz Amplifier Designs Using the HFET-2201
- 974 Die Attach and Bonding Techniques for Diodes and Transistors
- 975 A 4.3 GHz Oscillator Using the HXTR-4101 Bipolar Transistor
- 976 Broadband Microstrip Mixer Design—the Butterfly Mixer
- 977 A 300 Watt, 100 kHz, Off-Line Switch Mode Power Supply Using HPWR-6501 Power MOSFETs
- 978 The Design of GaAs FET Oscillators
- 1000 Digital Data Transmission with the HP Fiber Optical System
- 1001 Interfacing the HDSP-2000 to Microprocessor Systems
- 1002 Consideration of CTR Variations in Optically Coupled Isolator Circuit Designs
- 1003 Interfacing 18 Segment Displays to Microprocessors
- 1004 Threshold Sensing for Industrial Control Systems with the HCPL-3700 Interface Optocoupler
- 1005 Operational Considerations for LED Lamps and Display Devices
- 1006 Seven Segment Led Display Applications
- 1008 Optical Sensing with the HEDS-1000
- 1009 Snap-In Fiber Optic Link Application Note

- AB 1 Construction and Performance of High Efficiency Red, Yellow, And Green LED Materials
- AB 3 Soldering Hewlett-Packard Silver Plated Lead Frame LED Devices
- AB 4 Detection and Indication of Segmented Failures in 7-Segment LED Displays
- AB 5 Current Source for Diode Testing
- AB 6 Pin Diode RF Resistance Measurement
- AB 7 Mixer Distortion Measurements
- AB 13 Transistor Speed Up Using Schottky Diodes
- AB 14 Waveform Clipping with Schottky Diodes
- AB 15 Waveform Clamping with Schottky Diodes
- AB 16 Waveform Sampling with Schottky Diodes
- AB 17 Noise Parameters and Noise Circles for the HXTR-6101, -6102, -6104 and -6105 Low Noise Transistors
- AB 18 The Performance of the HXTR-6101 at Submilliampere Bias Levels
- AB 19 Noise and Power Parameters for the HFET-1101



- AB 24** Selecting a Design Medium for the HFET-2201 GaAs Field Effect Transistor
- AB 26** Using the HSCH-1001 Schottky Diode for Interfacing in Micro-processor Controlled A/D Conversion Circuits
- AB 27** Using the HSCH-1001 Schottky Diode in an AGC Detector Circuit
- AB 28** Optocoupler Speedup Using the HSCH-1001 Schottky Diode
- AB 30** Using the 5082-2835 Schottky Diode for Protecting and Improving the Performance of an Operational Amplifier
- AB 31** Using the HSCH-1001 Schottky Diode in a Data Terminal Memory
- AB 32** Power MOSFET Gate Drive Ideas
- AB 33** Loop Phase Gain Measurement of a Power MOSFET Switch Mode Power Supply
- AB 34** Power MOSFET Reliability Tests and Results
- AB 35** High Frequency Measurements of Power MOSFETs Using Oscilloscopes
- AB 36** Using the HSCH-1001 Schottky Diode in a Digital Logic Gate
- AB 54** Mechanical Handling of Sub-Miniature LED Lamps and Arrays
- AB 56** Interface Timing and Display Length Expansion Information for HDSP-2000 Coded Data Controller
- AB 57** Flux Budget Considerations for Fiber Optic Link Design
- GC 1-73** Analysis of Polychlorinated Biphenyls
- GC 2-73** Operating Conditions for Optimum Performance of the 5711A Flame Ionization Detector
- GC 3-73** Heroin Assay Using Gas Chromatography
- GC 4-73** Automatic Flame Photometric Analysis Without Solvent Flame-out
- GC 6-74** Determination of Acetaldehyde, Ethyl Acetate and Fusel Oils in Alcoholic Beverages
- GC 7-74** The Determination of Chromium by Gas Chromatography Using a Flame Photometric Detector
- GC 9-74** Classification of Anaerobic Bacteria by Gas Chromatography
- GC 1-75** The Gas Chromatographic Determination of Vinyl Chloride Monomer
- GC 2-75** Analysis of Essential Oils by Gas Chromatography
- GC 4-75** Automated Analysis of Essential Oils
- GC 3-76** The Analysis of Gas in Transformer Oils by Gas Chromatograph
- GC 6-76** Trace Organic Constituents in Water
- GC 8-76** The Gas Chromatographic Determination of Residual Acrylonitrile Monomer
- GC 9-76** Analysis of Ammonia Plant Gases
- GC 2-77** Therapeutic Drug Monitoring Performance Data for the Variable Volume Injection System
- IN-1** Quantitative Analysis with HP 1084A
- IN-3**

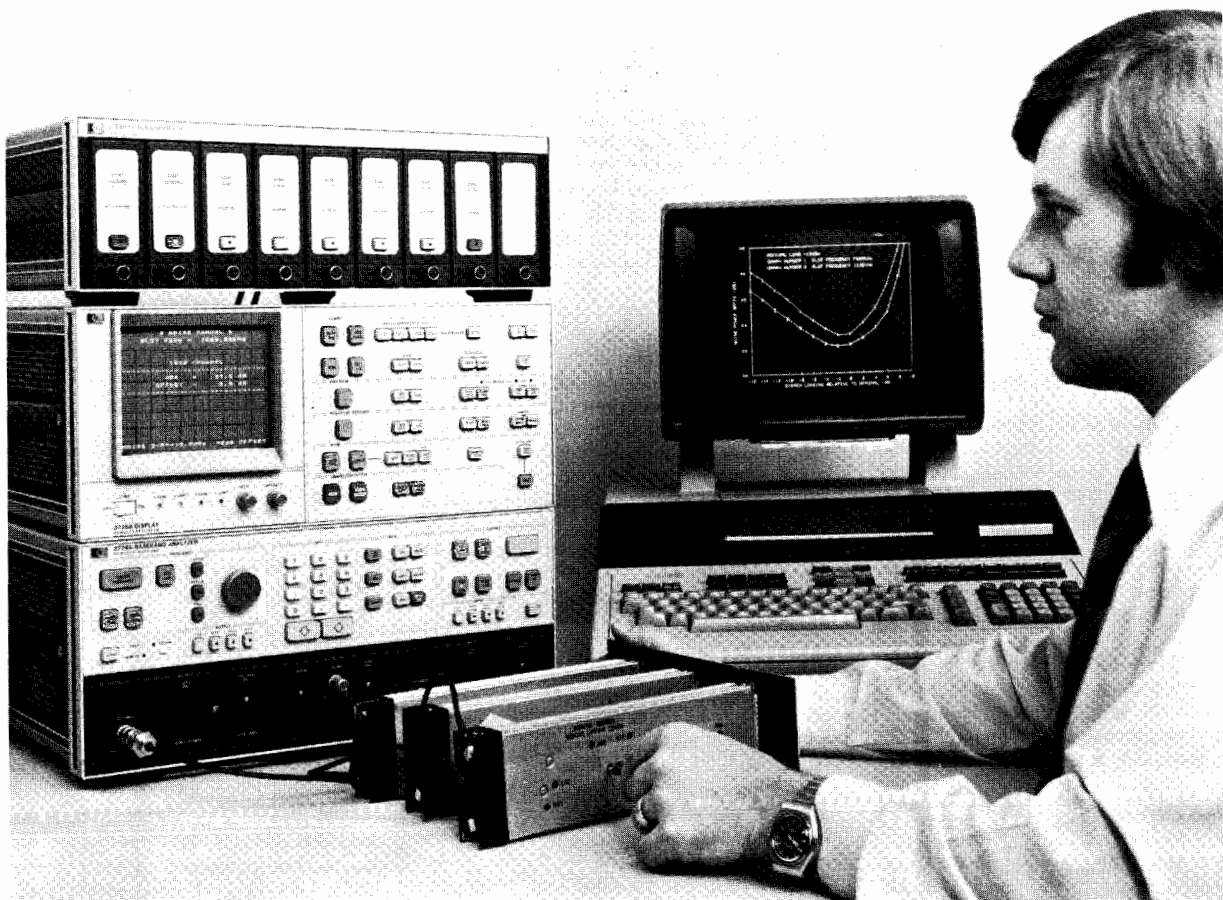



Training Alternatives

With Hewlett-Packard's extensive product line and worldwide customer mix there are two main avenues for technical customer training. These are live training sessions and video tapes. Live training sessions fall into three subcategories: applications, service and tutorial. Application seminars aimed at increasing your utilization of general purpose test instrumentation are often available at no charge. On the other hand, seminars on the operation of dedicated systems are more specific in nature and generally have a fee for tuition. Service seminars are available on a supply-and-demand basis and also have a tuition fee. For detailed information on all HP seminars, contact your Hewlett-Packard field engineer or call the Hewlett-Packard office nearest you—see pages 715-720.

HP Video Tapes

A Better Way to Learn

Part of the "extra value" which comes with each Hewlett-Packard product is our continuing commitment to provide Hewlett-Packard customers with useful training information in the areas of applications and service. In the past, this information has often been in the form of classroom seminars, either at your nearby Hewlett-Packard sales office or at one of our training facilities in California.

Now our capability is expanding by offering you both service and applications training via video tape. Video tape training is exceptionally convenient and readily available for your own use at any time or any place, including within your own facilities.

Effective: Hewlett-Packard has found that video tape is a highly effective training medium. Video tapes can convey more information in less time, and with higher retention, than even the best live instruction. Hewlett-

Packard programs are professionally produced and are based on measurable instructional objectives. They consider what the student already knows, emphasize what he needs to know, and omit what he does not need to know. Many video tapes utilize split-screen techniques, allowing students to watch a procedure on one part of the screen while observing its effect on another part. Most Hewlett-Packard video tapes are 100% visualized, as opposed to conventional, partially visualized video taped "lectures."

Flexible: With video tapes, you can tailor your training program to suit the many needs of your organization. You may select training programs for individuals with different backgrounds and specific needs, present effective programs to audiences of just one or hundreds, and offer a library of technical programs your staff members can easily consult on their own . . . for new information or for refresher purposes.

Faster: It has been our experience that Hewlett-Packard video programs compress learning time by a factor of up to 6-to-1. A video tape library also reduces the time needed to organize and schedule your training. You can schedule highly professional presentations anytime and anywhere, without arranging for outside instructors or juggling the detailed logistics that are often required for live training sessions. More effective training in one-sixth the time!

Convenient: Video tape programs come on small, easy-to-file magnetic tape cassettes. Inexpensive playback equipment is easily operated by unskilled personnel. Programs may be viewed on small portable monitors or on full-screen TV sets. Video tapes can be quickly searched for specific information using "fast forward" or "fast rewind," and many recorders can stop on a single frame for more detailed study.

Time-tested: All the video tapes offered in the Hewlett-Packard Videotape Catalog

were developed to serve Hewlett-Packard's needs for a practical, low cost source of up-to-date training in a wide variety of subjects. Now, after having been tested in Hewlett-Packard training activities throughout the world, many of these video programs are available to help meet your training objectives.

Understanding Microprocessors

90301RD

This videotape training module, developed to train HP technicians, provides a practical introduction to microprocessor systems.

Microprocessors are now found in the most familiar places: automobiles, kitchen appliances, toys, home entertainment devices, as well as in modern electronic instruments. Soon all electronic technicians must be able to troubleshoot and repair this type of equipment.

Understanding Microprocessors consists of 5 videocassette lessons in color, a textbook/experiment book, and a study guide. Each lesson concludes with a self-scoring quiz. The HP 5036A Microprocessor Lab is recommended for performing assigned experiments. The lessons are directed to technicians who already are able to troubleshoot and repair equipment using digital circuitry. After completing this module, technicians should be well prepared for more advanced microprocessor troubleshooting modules. The more advanced modules presently are offered as live tutorial training courses (see photo above). They are being produced in video format for future release.

What is a Microprocessor?

90302RD

Lesson 1

17 Mins.

This first lesson reviews the history of computers and microprocessor systems and provides an overview of the microprocessor video series. Microprocessor systems are graphically demonstrated along with the elements of microprocessor systems. Lesson 1 con-

cludes with a summary and a short self-scoring quiz.

Analog vs Digital Systems
90303RD Lesson 2 40 Mins.

The differences between analog and digital systems are never more apparent than when studying microprocessor systems. This program clearly describes these differences and goes on to explain the three-state bus concept, talkers and listeners, and bus troubleshooting techniques.

Introduction to Programming
90304RD Lesson 3 19 Mins.

This brief review of programming defines a few terms, describes what a program is, why programs are necessary, and how to develop them. The concepts of low and high level programs and a review precede the self-scoring quiz.

Processor Registers and Instruction Set
90305RD Lesson 4 30 Mins.

This lesson describes the many registers contained on the microprocessor chip, including their uses in the operational sequence: fetch, execute and increment. The instruction set is described briefly to enable the viewer to follow the succeeding lessons.

Simple Assembly Programming
90306RD Lesson 5 33 Mins.

Using the knowledge of the instruction set, the viewer is led through simple examples of assembly language programs. Translating the assembly language into machine language is shown, as well as how the program is stored in memory and executed by the processor. A program review precedes the self-scoring quiz.

Digital Troubleshooting 90420D

Developed to train HP's own technicians, this course is especially useful in showing how to approach real problems in real equipment.

- Practical demonstrations
- Proven teaching techniques
- Flexibility of use for classroom or individual study
- Latest in digital troubleshooting tools
- Most recent logic symbology
- Useful troubleshooting tips

Digital troubleshooting was made for technicians. It is an appropriate transition from transistors to digital electronics. It also can be used as a refresher course. Equivalent in coverage to a college term of 13 weeks, the course is presented in color on 14 videocassettes having a total running time of 5 hours and 31 minutes. The lab demonstrations shown in video are from the workbook included with the series. Also included is a 180 page text and a study guide.

There is ample use of reinforcement in the presentation and in the self-scoring quizzes at the end of most of the modules.

Digital Troubleshooting Videotapes

Introduction to Digital Electronics/
90421D Lesson 1 12 Mins.

Digital products and techniques are becoming more popular and widely used. This lesson looks at some of the areas where digital techniques are used—areas such as computers, communications, telemetry, test equip-

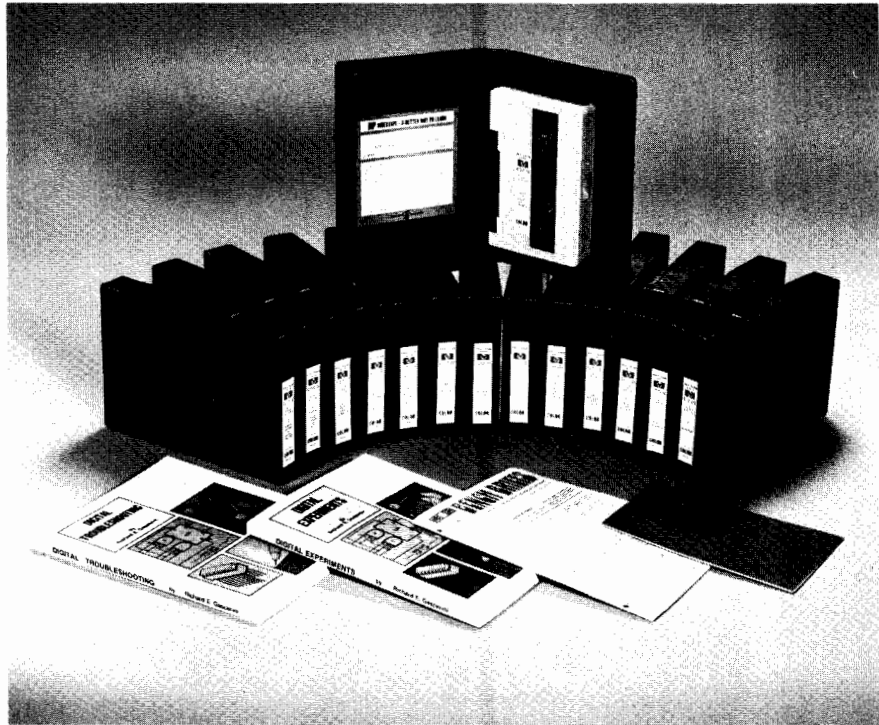

ment, industrial control, and consumer electronics. It also points out how the integrated circuit (IC) has caused a virtual explosion in the use of digital techniques. Widely used terms and concepts such as binary, digital, analog, gates, and memory are explained. The lesson concludes with a comparison of digital and analog techniques, a summary, and a short, self-scoring quiz.

Binary Nature of Digital Circuits
90422D Lesson 2 18 Mins.

Digital circuits operate using the binary or two-digit number system. Binary digits (bits) are introduced in this lesson covering the operation of the pure binary and Binary Coded Decimal (BCD) systems. Mechanical or transistor switches can be used to control the two logic levels used to represent binary data. Either positive or negative logic systems can be used to represent binary numbers, and they can be transmitted in either serial or parallel fashion. This lesson concludes with a summary and a short, self-scoring quiz.

Basics of Transistors and IC's
90423D Lesson 3 18 Mins.

Integrated Circuits have revolutionized digital electronics. An IC contains many transistorized circuits deposited on a tiny silicon chip. These transistorized circuits switch between two voltage levels that represent binary 1's and 0's. Because of their importance, this lesson reviews the basics of transistors and diodes. PN junction diodes are covered first, then PNP and NPN junction transistors are reviewed. The lesson then discusses how transistors can be operated as either saturated or non-saturated switches. Metal Oxide Semiconductor (MOS) transistor switches are also covered. Packaging and classification of Integrated Circuits are the final topic in this lesson followed by a summary and a short, self-scoring quiz.

Logic Gates and Symbols
9042D Lesson 4 25 Mins.

Logic gates and flip-flops are the two main digital building blocks. This program covers six basic logic gates and their symbols. The logic circuits covered are the AND, NAND, OR, NOR, Exclusive OR, and Inverter. After the operation of each logic element is explained using logic symbols, the operation of a circuit is demonstrated. Next, troubleshooting of gate circuits is covered, then the use of logic troubleshooting tools is demonstrated. The lesson ends with a summary and a short, self scoring quiz.

Note: The logic symbols included in this series are based on ANSI Y32.14/IEEE 91-193. This industry standard document supersedes MIL-STD-806 B/C and is approved for use by the U.S. Department of Defense.

Introduction to Digital IC Families
90425D Lesson 5 29 Mins.

This is the first of two lessons dealing with digital IC families. In this section DCTL, RTL, and DTL are covered.

This videotape begins with a review of logic gates consisting of the circuit diagram, truth table, logic diagram, and Boolean expression. Several schematics from an actual instrument are explained. Equivalent gates, shown on these schematics, are discussed according to function. This is followed by a discussion of the history of gate design as it applies to the digital troubleshooter, so that bad troubleshooting practices can be avoided. The lesson concludes with a short, self-scoring test.

Modern Digital IC Families
90426D Lesson 6 27 Mins.

This is the second of two lessons dealing with digital IC families. In this section TTL, HTL, ECL and CMOS are covered.

This videotape begins with a review of the principles introduced in Lesson 5, then explains how the five subfamilies of TTL work (Standard TTL, Low Power TTL, High

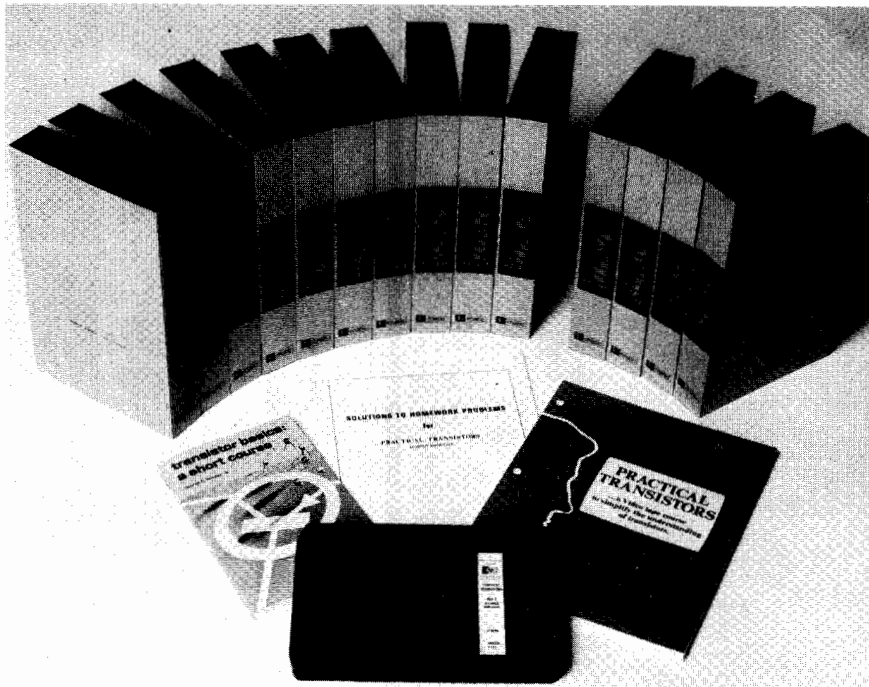

Speed TTL, Schottky TTL, and Lower Power Schottky TTL. Also explained are open-collector TTL and three-state logic. Similar discussion occurs about HTL, ECL, and CMOS families. The lesson concludes with troubleshooting as applied only to families.

Simple Troubleshooting Techniques 90427D Lesson 7 18 Mins.

Experienced service technicians use a number of simple troubleshooting tools and techniques to help reduce repair time and eliminate the need for electrical measurement, when servicing integrated circuit assemblies.

This program focuses attention on logical approach to troubleshooting, highlighting simple techniques of isolating and replacing defective components on integrated circuit assemblies.

Troubleshooting Digital IC's 90428D Lesson 8 27 Mins.

Fundamental differences between analog and digital circuits make traditional troubleshooting tools inefficient. Products designed especially for testing digital circuits include: The Logic Clip, Logic Probe, Logic Pulser, Current Tracer, and Logic Comparator. This program takes a close look at these IC Troubleshooters. Also covered are the types of failures found in digital integrated circuits and how to troubleshoot them.

Flip-flops 90429D Lesson 9 31 Mins.

Flip-flops are one of the main building blocks of digital circuits. This program covers both the NAND and NOR RS, closed RS, D, T, and JK flip-flops. The theory of operation of each flip-flop is covered using ANSI Y32.14/IEEE 91-1973 logic symbology. Then, the flip-flop is demonstrated and its operation summarized. Clocked logic, edge and level triggering, direct set and reset inputs,

and troubleshooting flip-flops are also covered.

Counters and Shift Registers 90430D Lesson 10 30 Mins.

Counters and Shift Registers are the two most popular uses of flip-flops. This program covers binary and decade counters, both ripple and synchronous types. Also covered are up and down counters, presettable counters, frequency dividers, circular shift registers and strobed displays. The operation of each circuit is first explained using logic symbols, then demonstrated. Troubleshooting is the final topic in this program. The lesson ends with a short, self-scoring quiz.

Combinational Logic Circuits 90431D Lesson 11 30 Mins.

The basic building blocks of combinational logic circuits are gates. In this videotape we see how gates are combined to form line drivers, three-state drivers, one-shot multivibrators, multiplexers, adders, and code converters.

After an overview of the operation of these devices, they're shown in actual use in a production line device.

The program concludes with a section on troubleshooting, which deals with typical problems which may arise in combinational logic circuits.

Display Technologies 90432D Lesson 12 30 Mins.

A large variety of display technologies is used with digital circuits. This program looks at the types and configurations of displays, then discusses typical troubleshooting problems specific to them. Some of the types covered are neons, gaseous discharge tubes, and light emitting diodes (both segmented and dot matrix forms). Included is a discussion on planar tubes, incandescent displays, and liquid crystals.

In the troubleshooting section typical faults the technicians might encounter are discussed. Each of these faults is demonstrated and solutions are suggested.

IC Manufacturing 90433D Lesson 13 11 Mins.

A basic knowledge of IC manufacturing should prove helpful to anyone involved in servicing digital equipment.

Manufacturing IC's involves a photographic process, and a series of masks is used to control the areas where impurities are allowed to diffuse forming semiconductors. This program shows the steps in the manufacture of IC's, starting with an actual wafer and following it through to a completed IC package.

Memories 90434D Lesson 14 25 Mins.

Due to the many unique demands of today's users of computers and calculating devices, many different configurations for different types of memory are required. This lesson considers six types of memory-punched paper tape, punched cards, magnetic (reel-to-reel and cartridge), magnetic disc (hard and floppy), ferrite core, and semiconductor.

This lesson defines and describes the use of sequential access and Random Access Memory (RAM), volatile and nonvolatile memory, Read/Write Memory, Read-Only Memory (ROM) and Programmable Read-Only Memory (PROM). Tips on handling the various types of memory conclude the program.

Practical Transistors 90100D

The widely used Practical Transistor Series is a definitive, monochrome, 15-tape excursion into the exceedingly important (and mysterious) world of transistors. As outlined below, each highly informative program in the wide-ranging series is primarily concerned with examining the many practical aspects of transistors rather than just dwelling on theory and math. The end result, after viewing this popular series, will be a deeper working understanding of transistors which will make maintenance and troubleshooting problems far easier and more efficient. The series is therefore highly recommended for electronics students, service personnel and engineers.

A supplementary textbook by transistor authority George Stanley Jr. (who also hosts the series), plus a complete set of homework problems and answers, is included with the nearly nine hours of video taped material.*

Transistors vs. Tubes 90030D330 Lesson 1 30 Mins.

The first program in the 15-part series introduces author George C. Stanley Jr., who defines the objectives of the course, describes the text upon which the course is based and explains the use of the homework problems. The rest of the program then reviews and builds upon the student's prior knowledge to make comparisons between vacuum tubes and transistors.

Temperature Effects
90030D316 Lesson 2 41 Mins.
 Part 2 develops the various common techniques of biasing transistors, and emphasizes the effects of heat on transistor circuits with demonstrations.

Current/Voltage Drive
90030D317 Lesson 3 41 Mins.
 Part 3 is concerned with the comparison between voltage drive and current drive in transistor circuits. During this program, several concepts are developed which become important building blocks for the rest of the course.

Answers by Inspection
90030D318 Lesson 4 43 Mins.
 Part 4 develops the first of several valuable timesaving rule-of-thumb formulas: a simplified expression for voltage gain. Demonstrations serve to illustrate the usefulness and effectiveness of this formula.

Answers by Inspection
90030D319 Lesson 5 40 Mins.
 Part 5 develops additional rule-of-thumb formulas for the calculation of voltage gain with feedback, input impedance, output impedance, and distortion in common emitter circuits.

Answers by Inspection
90030D331 Lesson 6 37 Mins.
 Part 6 concentrates on the emitter follower circuit and develops expressions for its voltage gain, and input and output impedance.

Multistage Amplifiers
90030D322 Lesson 7 44 Mins.
 Part 7 is devoted to applying the knowledge gained in Parts 4, 5, and 6 to an analysis of a three-stage transistor amplifier. Demonstrations on an actual circuit illustrate the accuracy of the approximations involved.

Troubleshooting
90030D323 Lesson 8 43 Mins.
 The information obtained in preceding programs is further clarified in Part 8, which covers troubleshooting on both single-stage and multi-stage transistor circuits. Class problems are presented and solved using actual circuits.

Feedback Amplifiers
90030D324 Lesson 9 27 Mins.
 Part 9 first reviews single-stage and multi-stage circuits with feedback. Valuable troubleshooting tips for feedback circuits are then illustrated with demonstrations.

Why a Transistor Amplifies
90030D325 Lesson 10 27 Mins.
 Part 10 illustrates how and why transistors amplify electrical signals. Discussion of the roles of majority and minority carriers leads to an intriguing example of the effect of nuclear radiation on transistor performance.

Troubleshooting
90030D326 Lesson 11 33 Mins.
 Part 11 is devoted to more practical applications of what has been learned so far. Demonstrations of troubleshooting are given on an actual multistage transistor amplifier to illustrate common failure patterns.

Fets and Unijunctions
90030D327 Lesson 12 34 Mins.
 Part 12 provides explanations of the operation of both junction and MOS field-effect transistors. Troubleshooting tips and the ef-

fects of nuclear radiation on these devices are given. The program concludes with the operation of the Unijunction transistor.

Breakdown Diodes
90030D328 Lesson 13 37 Mins.
 Part 13 compares Zener and avalanche diodes in terms of their temperature coefficient of voltage. This leads to a discussion of the use of various kinds of diodes for temperature compensation networks.

SCR's and Tunnel Diodes
90030D329 Lesson 14 28 Mins.
 Part 14 covers the operation and the uses for silicon controlled rectifiers and tunnel diodes. Special video effects help to explain the complexities of tunnel diode operation. Comparisons are then drawn to other semiconductor devices.

PIN, SRD, and HC Diodes
90030D332 Lesson 15 28 Mins.
 Part 15 explains step recovery diodes, hot carrier diodes, and PIN diodes, and outlines their typical applications. The series concludes with a short presentation on how the many special video effects were created for the various tapes in the series.

How to Use an Oscilloscope Series
90741D 1 hr, 16 Mins.
 The oscilloscope is one of the most versatile and widely used electronic test instruments. However, for best results it must be used properly. The purpose of this 3 videotape series, in color, is to train electronic technicians in the basic techniques of waveform measurement, using an oscilloscope. The HP1740A general purpose scope and the HP1741A storage scope are used in this series. However, the information presented will also help you operate other scopes.

Front Panel Controls
90742D Part I 27 Mins.
 This videotape will show you how to:
 (a) measure the peak-to-peak ac voltage, time period, frequency and dc component (if any) of a waveform;
 (b) measure low level signals such as power supply ripple;
 (c) trigger or synchronize the scope to obtain a stable display on the CRT; and
 (d) avoid errors in control settings that could lead to measurement inaccuracies.

Front Panel Controls (cont.)
90743D Part II 24 Mins.
 This program completes the coverage of the front panel controls of a general purpose oscilloscope. In Part I, only single channel operation was covered. This program covers dual channel operation. You will see how to operate a scope in the dual trace, A + B, A - B, and A versus B modes. Also covered are selectable and composite triggering, trigger view mode, bandwidth limit and delayed sweep operation.

Oscilloscope Measurements
90744D Part III 25 Mins.
 This program completes the series. It shows you how to check your scope and probe to make sure they are operating properly. You'll see that one probe cannot be used for all measurements, so the three types of commonly available voltage probes are covered. Then you will see how to make some typical oscilloscope voltage and time measurements.

Finally, storage scopes are covered. You will see how they can help you solve the problem of viewing low rep-rate signals and one-shot events. The program ends with a short summary.

How to Solder
90751D 35 Mins.
 This program is especially useful for training new hires who will work in electronic manufacturing and servicing—including those persons who believe they already know how to solder and unsolder properly.

Part I (16 minutes) covers:
 What is soldering Flux
 Wetting Soldering Irons
 Solder Tinning

Part 2 (19 minutes) shows:
 How to clean parts to be soldered
 The four basic soldering steps
 How to recognize a good solder connection
 How to unsolder, using the vacuum bulb, the solder-sucker, and the desoldering wick.

The program ends with a summary and a self-scoring quiz.

Ordering Information
 To order video programs, books, the HP 5035T Logic Lab or the 5036A Microprocessor Lab, please contact your local Hewlett-Packard sales office, addresses are listed on pages 715-720.

HP Product Number	Price
90301RD Understanding Microprocessors (5 videocassettes, plus a textbook/experiment book, and study guide).	\$1,700.*
Lab experiments are used to reinforce learning. They require access to a microprocessor lab such as the HP 5036A.	
90420D Digital Troubleshooting (14 videocassettes, plus a textbook, lab workbook, and study guide)	\$4,000*
Lab experiments are used to reinforce learning. They require access to a digital experimenter's kit such as the HP 5035T Logic Lab.	
90100D Practical Transistors (15 monochrome videocassettes plus a textbook, workbook problem sets)	\$1,950.00*
90741D How to Use an Oscilloscope Series	\$750.00*
90751D How to Solder	\$395.00
22958B RTE Fortran Independent Study Course (6 videocassettes (color) and workbook). Access to an HP 1000 with an RTE IVB operating system is required.	\$1000

Local taxes, shipping and handling will be added to all orders.

Midterm examinations, final examination, examination solutions and certificates of completion are supplied with the purchase of 90100D and 90420D, but are shipped separately. See your local HP field engineer for details.

Video programs are supplied in NTSC Standard only.

Available formats are 3/4" U Matic, 1/2" VHS and 1/2" Beta I.
 Domestic U.S. Prices only.
 *Not eligible for quantity discount.



POST-SALE SUPPORT SERVICE

Warranty, Certification, Parts, Publications

When you purchase a Hewlett-Packard product, you also receive the assurance that it will continue to perform to its published specifications today, tomorrow, and for a reasonable number of years in the future.

We firmly believe that our obligation to you as a customer goes beyond delivery of your new HP product. This philosophy is implemented in two ways: (1) by designing and building excellent products with good serviceability, and (2) by backing those products with customer support programs which quickly respond to all your needs.

HP customer support service programs provide responsive support services from HP and distributor organizations in countries throughout the world. (Their support capabilities are specified in the sales/support office listing inside the back cover of this catalog.) These programs are one of the major reasons for Hewlett-Packard's reputation of integrity and responsibility.

Warranty

As an expression of confidence that our products will continue to meet the high standards of reliability and performance that our customers expect, Hewlett-Packard products carry the following warranty:

Hewlett-Packard (HP) products are warranted against defects in materials and workmanship. The warranty period for each product will be provided on request at the time of sale, and is specified in documentation supplied with the product. During the warranty period, HP will, at its option, either repair or replace products which prove to be defective.

Warranties requiring return-to-HP are not limited to the country of purchase. Parts and labor are provided during the warranty period when the customer returns the product to any office designated by HP for repair of the product.

HP warrants that its software and firmware designated by HP for use with a CPU or instrument will execute its programming instructions when properly installed on that CPU or instrument. HP does not warrant that the operation of the CPU, instrument, software, or firmware will be uninterrupted or error free.

Installation services provided during warranty and on-site warranty services are available only in HP Service Travel Areas, and only in the country of initial purchase, unless buyer pays HP international prices. On-site warranty service for those products requiring installation services is provided only at the initial installation point.

If the buyer transports his product from the initial country of purchase without paying HP international prices, then any remaining warranty covers parts and labor only. The customer can return the product to any office designated by HP for repair of the product. In this case, the customer can obtain on-site warranty service if the location is one where HP can normally provide on-site service for the product by paying HP established travel charges and, if required for the product, purchasing all necessary installation services from HP.

Buyer shall prepay shipping charges for products returned to HP for warranty ser-

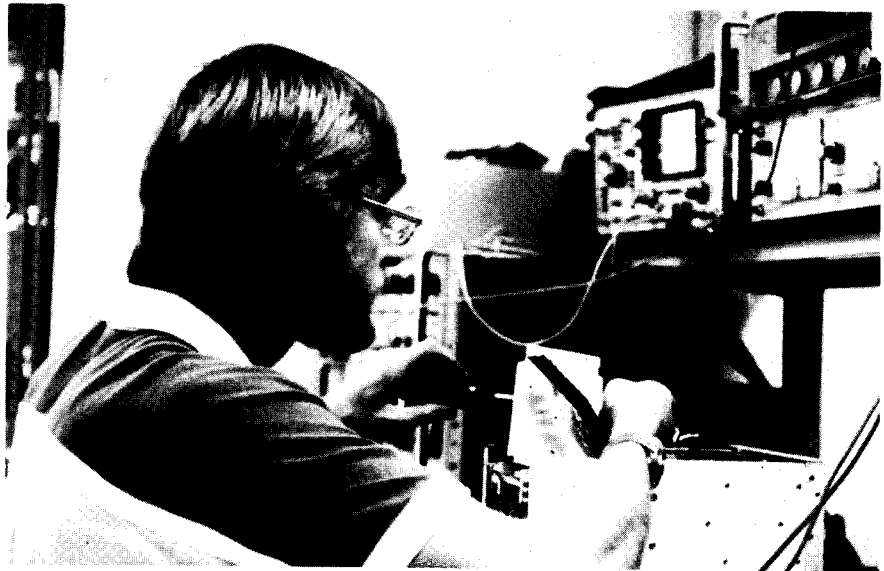

vice; and HP shall pay for return of the products to buyer. However, buyer shall pay all shipping charges, duties and taxes for products returned to HP from another country.

Limitation of warranty

The foregoing warranty shall not apply to defects resulting from:

- 1. Improper or inadequate maintenance by buyer;*
- 2. Buyer-supplied software or interfacing;*
- 3. Unauthorized modification or misuse;*
- 4. Operation outside of the environmental specifications for the product; or*
- 5. Improper site preparation or maintenance.*

NO OTHER WARRANTY IS EXPRESSED OR IMPLIED. HP SPECIFICALLY DISCLAIMS THE IMPLIED WARRANTIES OF MERCHANTABILITY AND FITNESS FOR A PARTICULAR PURPOSE.

Exclusive remedies

The remedies provided herein are buyer's sole and exclusive remedies. HP shall not be liable for any direct, indirect, special, incidental, or consequential damages, whether based on contract, tort or any other legal theory.

Certification

Hewlett-Packard testing and quality assurance programs are documented in a Certificate of Conformance which is available upon request at the time of purchase. This certificate states:

Products, materials, parts and services furnished on this order have been provided in accordance with all applicable Hewlett-Packard specifications. Actual inspection and test data pertaining to this order is on file and available for examination.

Hewlett-Packard's calibration measurements are traceable to the National Bureau of Standards to the extent allowed by the Bureau's calibration facilities.

Replacement Parts and Supplies

Replacement parts play a key role in Hewlett-Packard's customer support services program. Hewlett-Packard's strategically locat-

ed parts centers supply parts to both HP field operations and our customers. HP's field operations maintains extensive parts inventories at repair centers and local service responsible offices to assure prompt repair of your product.

The reliability and product life of HP products can be enhanced by the use of quality operating supplies. Hewlett-Packard provides a complete selection of high quality supplies for electronic instruments, medical products, and computer systems. Separate catalogs describing the supplies offered for each product line are available from your local HP office.

When ordering replacement parts or supplies from your local office, please specify the correct HP part number and description obtained from product documentation, a parts price list, or the appropriate supplies catalog. If you do not know the part number, please include the product model number, serial number, and a complete description of the item, its function and location within the product. These orders are generally shipped from HP parts centers on the next working day. Replacement parts are not available for the handheld calculator line.

Service Publications

The *Operating and Service Manual* supplied with each Hewlett-Packard test and measuring product contains maintenance, calibration, diagnostic and repair procedures, with troubleshooting charts and circuit diagrams. All replaceable parts are listed. Extra manuals are available from your nearby Hewlett-Packard field office. Most operating and service manuals, manual updates, and *Service Notes* are now available on COSATI standard, positive microfiche.

Bench Briefs, a periodic newsletter, has service tips, new modifications, and other suggestions to help repair and maintenance personnel get maximum performance from Hewlett-Packard instruments. It describes new *Service Notes* and other company publications as they become available. To become a regular subscriber, ask your local HP office to place your name on the mailing list.

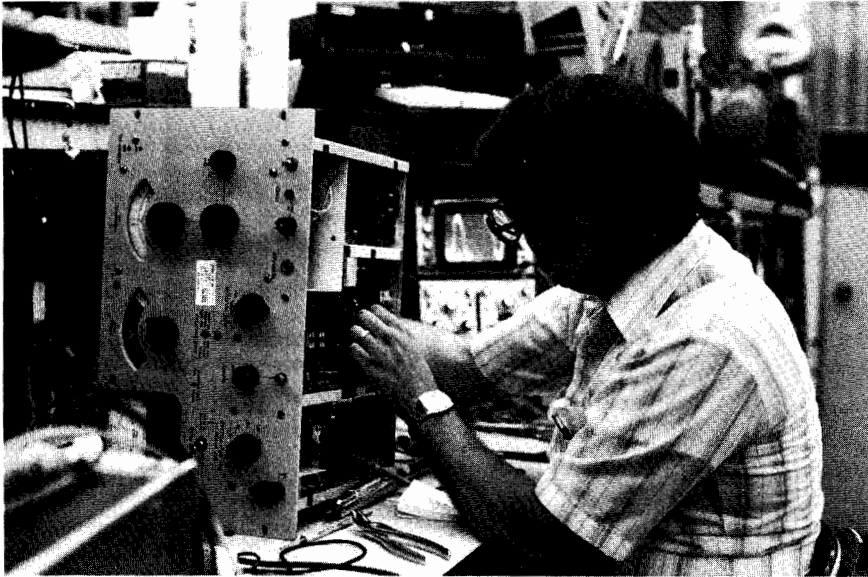

Service Responsible Offices

Providing complete support services when and where you need them is one of Hewlett-Packard's primary goals. Throughout the world, Hewlett-Packard has established HP Service Responsible Offices (SROs) to meet the support requirements of all HP customers.

Hewlett-Packard's worldwide support is further enhanced by the use of privately-owned companies operating as distributors for the sale and support of selected products. You should contact these companies directly or through your nearest HP SRO for information on available services.

Since it is impractical for offices to support products not marketed within their assigned territory, all products within a given product category are not supported by every HP office. The office list in the back of this catalog identifies the product lines supported by each office. For more specific information about office capability, contact your nearest HP Sales/Support office.

Travel for on-site services

Each Hewlett-Packard Service Responsible Office is surrounded by defined travel zones which are used to quote both response times and travel charges for specified on-site services. Hewlett-Packard routinely provides its on-site support services within defined travel areas of each country where the products are sold. In many instances these travel areas encompass the entire country. However, there are instances which prohibit routine travel such as geographical obstacles, underdeveloped roads, or unsuitable public transportation. In such cases these areas will be excluded from routine travel. Your HP SRO will be able to provide information regarding excluded travel areas, as well as response times and charges for on-site service.

Customer Support Services Agreement

Hewlett-Packard offers a wide range of service programs for products and systems under a Customer Support Services Agreement (CSSA). This ongoing agreement features a known cost billed on a periodic basis. Products and service programs can be added to the agreement as required. On-site services can be provided at multiple locations within a country under a single CSSA.

Electronic Instruments/Measurement Systems

Hewlett-Packard offers a variety of service programs for instruments and measurement systems. HP instrument repair centers located around the world support HP instrument products under several CSSA programs. A Calibration Agreement assures ongoing instrument performance checks at either HP or customer recommended intervals. A Repair Agreement provides an insurance policy for instrument failures resulting from normal use. Both these services can be obtained under a Full Service Agreement.

HP also offers a number of on-site support services under CSSA for HP measurement systems products. These programs provide a choice among optional levels of response, hours of coverage, critical instrument sparring, installation and training. Additional information is available from your HP Sales Representatives.

Analytical Instrumentation

Analytical on-site Product Maintenance Service includes comprehensive repairs (all parts except certain expendables and consumables), labor and travel. Routine customer maintenance training can be provided at customer request and, as an option, installation for instruments where it is not nor-

mally provided. Normal on-site response to a service request is 1 day.

Computer Products/Systems

A wide variety of hardware and software support programs are available for computer systems, desktop computers, terminals and related peripherals. Sufficient flexibility exists to allow you to tailor a comprehensive program for your site at a reasonable cost. See *Computer Support* (pp. 696-699) for more information or contact your HP Sales Representative.

Medical products systems

Specialized service plans are available for medical products and systems under the CSSA. In addition to an agreement covering on-site repairs, HP offers options for Safety Assurance Checks, Performance Assurance Checks, or both.

Per-call Service

Per-call service can meet your need for repairs, installation, site planning, site surveys, calibrations, preventive maintenance, safety and performance checks, overhauls and technical assistance. These services are available at your site, or at HP Repair Centers located around the world.

For many Hewlett-Packard products, the labor and parts costs for repair of failures resulting from normal use have been combined into a convenient Standard Repair Charge which can be quoted prior to the repair. If a Standard Repair Charge has not been established, per-call services are performed on a time and material basis.

Maintenance and Customer Training

Maintenance training is available on both a formal and informal basis for specific HP products. Product Service Seminars, covering theory of operation, service techniques, and component level repair are provided for some electronic instruments. Scheduled training courses for selected computer products cover theory of operation, and assembly level troubleshooting in a classroom and lab environment. Depending upon availability, HP personnel can provide maintenance training at your facility on a time and material basis.

For more efficient utilization of HP products, systems and software, HP offers a wide variety of customer training courses at HP Customer Training Centers located around the world. Experienced Systems Engineers teach courses ranging from general introductions to advanced training on specific products or applications. Contact your local HP office for a training schedule which lists course descriptions, training locations and dates.

ORDERING INFORMATION

Shipping, Prices, and Terms of Sale



Communicating With HP

Hewlett-Packard is committed to providing convenient local support and the best possible attention to customer needs on a worldwide basis. There are more than 172 sales offices and representatives, many of which provide service, located in 65 countries; a listing of these offices commences on page 749.

Your entry point to the resources of Hewlett-Packard is through the local HP office nearest you. Our sales representatives and order support specialists there are well-equipped to provide you with pre-sale assistance in product selection, as well as related business information such as current product availability and price delivered to your location.

Many HP sales offices are tied into a sophisticated intra-company communications system. This not only means prompt transmission of orders to any HP product responsible division—it also speeds the flow of regular messages among HP sales offices and factories. The objective, of course, is to provide the fastest possible response to your product interests.

Placing Your Order

Hewlett-Packard people at the sales office nearest you will be pleased to provide assistance in selecting the HP equipment most appropriate to your needs, and to help you prepare your order.

The information in this catalog will, in many cases, be sufficient for you to decide to buy a particular HP product. In those instances, a telephone call to the nearest HP office will provide you with (1) information

on product availability, and (2) the product's price.

HP wants to be sure the product delivered to you is exactly the one you want. Therefore, when placing your order, please specify the product's catalog (model, accessory, or part) number, as well as the product's name. Be as complete as possible in specifying exactly what you'd like, including standard options.

In the event you want special features or capabilities such as different color or a non-standard power line voltage, ask your HP sales representative about availability and cost of these "specials" first—and then, to prevent misunderstandings, include special instructions and specification details with your order.

Shipping Methods

Inside the USA: Shipments to destinations in the USA are made directly from factories or local warehouses. Unless specifically requested otherwise, express or truck transportation is used, whichever is less expensive and most seviceable to you. Small items are sent parcel post or UPS. If fast delivery is needed, we gladly ship by air freight, air express, or air parcel post, when specified on your order, at prevailing rates. In many parts of the USA, a consolidated air freight service provides the speed of air transport at surface rates. Ask your HP sales representative for details.

Outside the USA: Shipments to destinations outside the USA are made from the appropriate Hewlett-Packard facility by either surface or air, as requested. Sea shipments usually require commercial export packaging at a nominal extra charge.

Budgetary Prices

Price information which may be supplied with this catalog provides you with helpful budgetary guidance.

Prices appearing in this catalog, unless otherwise specified, are F.O.B. U.S.A. factory or shipping point and apply only to domestic U.S.A. customers for use in the U.S.A.

Please call your nearby Hewlett-Packard sales office to determine a product's delivered price outside of the U.S.A.

Prices furnished with this catalog are net prices prevailing at the time of printing. Hewlett-Packard reserves the right to change prices, and those prices prevailing at the time an order is received will apply.

Quotations and Pro Forma Invoices

Destination prices and other details you may need to know before ordering can be quickly obtained via telephone. Just call your nearest HP office.

If you are an international customer requiring formal paperwork such as pro forma invoices or quotations, please contact the Hewlett-Packard office or representative serving your area. Exportation or importation assistance is also available.

Terms of Sale

Inside the USA: Hewlett-Packard's standard credit terms for established customers in the USA are net 30 days from invoice date. If credit with Hewlett-Packard has not already been established, shipments will be made COD or on receipt of cash in advance.

Leasing and extended financial terms are available. However, the associated costs are not included in any product prices furnished with this catalog. Your nearby HP office will be pleased to discuss your requirements and work with you in setting up an appropriate program.

Outside the USA: Terms for orders placed on Hewlett-Packard Company by customers outside the USA are irrevocable letters of credit or cash in advance—unless other terms have been previously arranged. Please contact authorized Hewlett-Packard international subsidiaries or distributors regarding terms for orders placed with them.

U.S. Government Sales

Some products in this catalog are covered on GSA federal supply schedule multi-award contracts.

Product Changes

Although product information and illustrations in this catalog were current at the time it was approved for printing, Hewlett-Packard, in a continuing effort to offer excellent products at a fair value, reserves the right to change specifications, designs, and models without notice.

NOTES: 1. Minimum order in USA \$20, except where cash is received with order on over-the-counter or direct mail sales.
2. Not all HP-IB instruments are furnished with interconnecting cables; see page 30.



Product Line Sales / Support Key

Key	Product Line
A	Analytical
CM	Components
C	Computer Systems Sales only
CH	Computer Systems Hardware Sales & Services
CS	Computer Systems Software Sales & Services
E	Electronic Instruments & Measurement Systems
M	Medical Products
MP	Medical Products Primary SRO
MS	Medical Products Secondary SRO
P	Consumer Calculators
*	Sales only for specific product line
**	Support only for specific product line

IMPORTANT: These symbols designate general product line capability. They do not insure sales or support availability for all products within a line, at all locations. Contact your local sales office for information regarding locations where HP support is available for specific products.

HP distributors are printed in italics.

ANGOLA

Telectra
Empresa Técnica de Equipamentos
Eléctricos, S.A.R.L.
R. Barbosa Rodrigues, 41-I DT.
Caixa Postal 6487
LUANDA
Tel: 35515,35516
E,M,P

ARGENTINA

Hewlett-Packard Argentina S.A.
 Avenida Santa Fe 2035
 Martinez 1640 **BUENOS AIRES**
 Tel: 798-5735, 792-1293
 Telex: 122443 AR CIGY
 Cable: HEWPACKARG
 A,E,CH,CS,P

Biotron S.A.C.I.y.M
Av Paseo Colon 221, 9 Piso
 1399 **BUENOS AIRES**
Tel: 30-4846, 30-1851, 30-8384
Telex: 17595 BION/AR
 M

Fate S.A. I.C.I./Electronica
Venezuela 1326
 1095 **BUENOS AIRES**
Tel: 379026, 379027
Telex: 18137, 22754 ALVAR AR
 P

AUSTRALIA

Adelaide, South Australia Office
 Hewlett-Packard Australia Pty.Ltd.
 153 Greenhill Road
PARKSIDE, S.A. 5063
 Tel: 272-5911
 Telex: 82536
 Cable: HEWPARDA Adelaide
 A*,CH,CM,,E,MS,P

Brisbane, Queensland Office
 Hewlett-Packard Australia Pty.Ltd.
 5th Floor
 Teachers Union Building
 495-499 Boundary Street
SPRING HILL, Queensland 4000
 Tel: 229-1544
 Telex: 42133
 Cable: HEWPARDBrisbane
 A,CH,CM,,E,MS,P

Canberra, Australia Capital Territory Office
 Hewlett-Packard Australia Pty.Ltd.
 121 Wollongong Street
FYSHWICK, A.C.T. 2609
 Tel: 80 4244 Telex: 62650
 Cable: HEWPARDCanberra
 A*CH,CM,E,MS,P

Melbourne, Victoria Office
 Hewlett-Packard Australia Pty.Ltd.
 31-41 Joseph Street
BLACKBURN, Victoria 3130
 Tel: 89-6351
 Telex: 31-024
 Cable: HEWPARDMelbourne
 A,CH,CM,CS,E,MS,P

Perth, Western Australia Office
 Hewlett-Packard Australia Pty.Ltd.
 261 Stirling Highway
CLAREMONT, W.A. 6010
 Tel: 386-5455
 Telex: 93859
 Cable: HEWPARD Perth
 A,CH,CM,,E,MS,P

Sydney, New South Wales Office
 Hewlett-Packard Australia Pty.Ltd.
 17-23 Talavera Road
 P.O. Box 308
NORTH RYDE, N.S.W. 2113
 Tel: 887-1611
 Telex: 21561
 Cable: HEWPARDSydney
 A,CH,CM,CS,E,MS,P

AUSTRIA

Hewlett-Packard Ges.m.b.h.
 Grottenhofstrasse 94
 Verkaufsburo Graz
A-8052 GRAZ
 Tel: 21-5-66
 Telex: 32375
 CH,CM,E*

 Hewlett-Packard Ges.m.b.h.
 Wehlstrasse 29
 P.O. Box 7
A-1205 VIENNA
 Tel: (222) 35-16-210
 Telex: 135823/135066
 A,CH,CM,CS,E,MS,P

BAHRAIN

Green Salon
P.O. Box 557
BAHRAIN
Tel: 25503-250950
Telex: 84419
 P

Wael Pharmacy
P.O. Box 648
BAHRAIN
Tel: 256123
Telex: 8550 WAEL GJ
 M

BELGIUM

Hewlett-Packard Belgium S.A./N.V.
 Blvd de la Woluwe, 100
 Woluwedal
B-1200 BRUSSELS
 Tel: (02) 762-32-00
 Telex: 23-494 paloben bru
 A,CH,CM,CS,E,MP,P

BRAZIL

Hewlett-Packard do Brasil I.e.C. Ltda.
 Alameda Rio Negro, 750
ALPHAVILLE 06400 Barueri SP
 Tel: 421-1311
 Telex: 011 33872
 Cable: HEWPACK Sao Paulo
 A,CH,CM,CS,E,MS

 Hewlett-Packard do Brasil I.e.C. Ltda.
 Avenida Epitacio Pessoa, 4664
22471 RIO DE JANEIRO-RJ
 Tel: 286-0237
 Telex: 021-21905 HPBR-BR
 Cable: HEWPACK Rio de Janeiro
 A,CH,CM,E,MS,P*

CANADA

Alberta

Hewlett-Packard (Canada) Ltd.
 210, 7220 Fisher Street S.E.
CALGARY, Alberta T2H 2H8
 Tel: (403) 253-2713
 A,CH,CM,E*,MS,P*

Hewlett-Packard (Canada) Ltd.
 11620A-168th Street
EDMONTON, Alberta T5M 3T9
 Tel: (403) 452-3670
 A,CH,CM,CS,E,MS,P*

British Columbia

Hewlett-Packard (Canada) Ltd.
 10691 Shellbridge Way
RICHMOND, British Columbia V6X 2W7
 Tel: (604) 270-2277
 Telex: 610-922-5059
 A,CH,CM,CS,E*,MS,P*

Manitoba

Hewlett-Packard (Canada) Ltd.
 380-550 Century Street
WINNIPEG, Manitoba R3H 0Y1
 Tel: (204) 786-6701
 A,CH,CM,E,MS,P*

New Brunswick

Hewlett-Packard (Canada) Ltd.
 190 Wilbur Street
MONCTON, New Brunswick E2B 2V0
 Tel: (506) 386-1677
 Telex: 01931470
 CH**

Nova Scotia

Hewlett-Packard (Canada) Ltd.
 P.O. Box 931
 900 Windmill Road
DARTMOUTH, Nova Scotia B2Y 3Z6
 Tel: (902) 469-7820
 Telex: 01931470
 CH,CM,CS,E*,MS,P*



SALES & SUPPORT OFFICES

Arranged alphabetically by country

Product Line Sales/Support Key

Key	Product Line
A	Analytical
CM	Components
C	Computer Systems Sales only
CH	Computer Systems Hardware Sales & Services
CS	Computer Systems Software Sales & Services
E	Electronic Instruments & Measurement Systems
M	Medical Products
MP	Medical Products Primary SRO
MS	Medical Products Secondary SRO
P	Consumer Calculators
*	Sales only for specific product line
**	Support only for specific product line

IMPORTANT: These symbols designate general product line capability. They do not insure sales or support availability for all products within a line, at all locations. Contact your local sales office for information regarding locations where HP support is available for specific products.

HP distributors are printed in italics.

CANADA (Con't.)

Ontario

Hewlett-Packard (Canada) Ltd.
552 Newbold Street
LONDON, Ontario N6E 2S5
Tel: (519) 686-9181
Telex: 610-352-1201
A,CH,CM,E*,MS,P*

Hewlett-Packard (Canada) Ltd.
6877 Goreway Drive
MISSISSAUGA, Ontario L4V 1M8
Tel: (416) 678-9430
Telex: 610-492-4246
A,CH,CM,CS,E,MP,P

Hewlett-Packard (Canada) Ltd.
2670 Queensview Dr.
OTTAWA, Ontario K2B 8K1
Tel: (613) 820-6483
Telex: 610-563-1636
A,CH,CM,CS,E*,MS,P*

Quebec

Hewlett-Packard (Canada) Ltd.
17500 South Service Road
Trans-Canada Highway
KIRKLAND, Quebec H9J 2M5
Tel: (514) 697-4232
Telex: 05821521
A,CH,CM,CS,E,MP,P*

Hewlett-Packard (Canada) Ltd.
Les Galeries du Vallor
2323 Boulevard du Versant Nord
STE. FOY, Quebec G1N 4C2
Tel: (418) 687-4570
CH

CHILE

Jorge Calcagni y Cia. Ltda.
Arturo Burhle 065
Casilla 16475
SANTIAGO 9
Tel: 222-0222
Telex: Public Booth 0001
A,CM,E,M

Olympia (Chile) Ltd.
Rodrigo de Araya 1045
Casilla 256-V
SANTIAGO 21
Tel: 225-5044
Telex: 40565 OLYMP CL
C,P

CHINA, People's Republic of

CEIEC Inc.
44 Beiwei Rd.
BEIJING, China
Telex: 22475 CEIEC CN
A,CH,CM,CS,E,P

COLOMBIA

Instrumentación
H. A. Langebaek & Kier S.A.
Apartado Aéreo 6287
BOGOTÁ 1, D.E.
Carrera 7 No. 48-75
BOGOTÁ 2, D.E.
Tel: 287-8877
Telex: 44400
Cable: AARIS Bogota
A,CM,E,M,P

COSTA RICA

Cientifica Costarricense S.A.
Avenida 2, Calle 5
San Pedro de Montes de Oca
Apartado 10159
SAN JOSE
Tel: 24-38-20, 24-08-19
Telex: 2367 GALGUR
CM,E,M

CYPRUS

Telex Ltd.
P.O. Box 4809
14C Stassinou Avenue
NICOSIA
Tel: 62698
Telex: 2894 Levidocy
E,M,P

CZECHOSLOVAKIA

Hewlett-Packard
Obchodni Zastupitelstvi v CSSR
Post. schranka 27
CS-118 01 PRAHA 011
Tel: 66-296
Telex: 121353 IHC

DENMARK

Hewlett-Packard A/S
Datavej 52
DK-3460 **BIRKEROD**
Tel: (02) 81-66-40
Telex: 37409 hpas dk
A,CH,CM,CS,E,MS,P

Hewlett-Packard A/S
Navervej 1
DK-8600 **SILKEBORG**
Tel: (06) 82-71-66
Telex: 37409 hpas dk
CH,CM,E

ECUADOR

CYEDE Cia. Ltda.
Avenida Eloy Alfaro 1749
Casilla 6423 CCI
QUITO
Tel: 450-975, 243-052
Telex: 2548 CYEDE ED
A,CM,E,P

Hospitalar S.A.
Robles 625
Casilla 3590
QUITO
Tel: 545-250, 545-122
Telex: 2485 HOSPPL ED
Cable: HOSPITALAR-Quito
M

EGYPT

International Engineering
Associates
24 Hussein Hegazi Street
Kasr-el-Aini
CAIRO
Tel: 23-829
Telex: 93830
CH,CS,E,M

Informatic For Systems
22 Talaat Harb Street
CAIRO
Tel: 759006
Telex: 93938 FRANK UN
CH,CS,P

Egyptian International Office
for Foreign Trade
P.O.Box 2558
CAIRO
Tel: 984935
Telex: 93337 EGPOR
P

EL SALVADOR

IPESA de El Salvador S.A.
Boulevard de los Heroes 1148
SAN SALVADOR
Tel: 252787, 259621
Telex: Public Booth 20107
A,CH,CM,CS,E,P

FINLAND

Hewlett-Packard Oy
Revontulentie 7
SF-02100 **ESPOO 10**
Tel: (90) 455-0211
Telex: 121563 hewpa sf
A,CH,CM,CS,E,MS,P

FRANCE

Hewlett-Packard France
Le Ligoures
Bureau de Vente de Aix-en-Provence
Place Romée de Villeneuve
F-13090 **AIX-EN-PROVENCE**
Tel: (42) 59-41-02
Telex: 410770F
A,CH,CM,E,MS,P*

Hewlett-Packard France
Boite Postale No. 503
F-25026 **BESANCON**
28 Rue de la Republique
F-25000 **BESANCON**
Tel: (81) 83-16-22
CH,M